

HÖGERT TECHNIK
Brand ambassador
Paweł Trela

Polish Drifting Champion

Werkzeuge für Anspruchsvolle

Wir bieten wertvolle Lösungen, die Langlebigkeit und Funktionalität miteinander verbinden. Unsere Produkte sind für anspruchsvolle Anwender und intensive Nutzung konzipiert. Die Marke Högert Technik richtet sich an Profis, die bei ihrer täglichen Arbeit Handwerkzeuge einsetzen.

Kundenzufriedenheit ist unsere Priorität. Wir garantieren:

- Hilfe bei der Produktauswahl;
- Schnelle Ausführung von Bestellungen;
- Effiziente Logistik;
- Umfassende Marketingunterstützung.



ERWEITERTE GARANTIE

Wir bieten eine lebenslange oder 25-jährige Garantie für ausgewählte Werkzeugsets und Produkte von Högert Technik. Die Garantie gilt innerhalb der Europäischen Union und bezieht sich auf die während der Garantiezeit offenbaren Fertigungs- und Materialfehler.

QUALITÄTSKONTROLLE

Högert Technik Produkte erfüllen die wichtigsten Qualitätsstandards. Qualität ist das höchste Maß der Marke Högert Technik. Unsere Produkte werden vor dem Verkauf einer Reihe von Tests und externen Audits unterzogen. Wir sind ständig auf der Suche nach neuen Lösungen, die unseren Kunden die Arbeit erleichtern – und um die Messlatte nicht nur für uns, sondern auch für unsere Wettbewerber höher zu legen.



DER MOBILE DEMO-WAGEN

Die multifunktionale Markenplattform bietet kostenlose Präsentationen und Schulungen zum Werkzeugsortiment von Högert Technik: Shows, Produkt tests, Tipps, Wettbewerbe mit Preisen.

B2B PLATTFORM FÜR VERTRIEBSHÄNDLER

Bietet schnelles und intuitives Einkaufen und vollen Zugriff auf das Produktangebot 24 Stunden am Tag, 7 Tage die Woche, ohne geographische Einschränkungen.

Über die B2B-Plattform bieten wir Zugang zu: aktuelle Preise und Lagerbestände, Produktfotos, Datenblätter und detaillierte Produktinformationen, Status der Auftragsabwicklung und Handelsunterlagen.

API - AUTOMATISIERTER DATENAUSTAUSCH

Um die Arbeit unserer Geschäftspartner effizienter zu gestalten, bieten wir die Integration von Shops und Websites mit der zentralen Högert Technik Produktdatenbank an.

Social Media – Bleiben Sie auf dem Laufenden!

Unsere Aktivität auf den Plattformen Facebook und YouTube umfasst aktuelle Informationen über das Leben der Marke sowie Produktneuheiten, Tipps und Präsentationen ausgewählter Produkte aus dem Angebot.



INFLUENCER MARKETING und SPORT-MARKETING

Wir arbeiten daran, die Marke Högert Technik im In- und Ausland bekannt zu machen, unter anderem durch die Zusammenarbeit mit Influencern oder Sponsoring von Sportwettbewerben.

SOZIALE VERANTWORTUNG

Seit dem Beginn unserer Tätigkeit haben wir die Notwendigkeit erkannt, technische Berufe zu fördern und lokale Organisationen zu unterstützen. Deshalb beteiligen wir uns an Veranstaltungen, die profilierte Schulen fördern und über den Stellenmarkt für spezialisierte Branchen informieren. Wir unterstützen Organisationen, indem wir Werkzeuge bereitstellen, die ihre tägliche Arbeit erleichtern.

PRODUKTKATEGORIEN

Das Portfolio der Marke wird ständig erweitert. Als Reaktion auf die Marktnachfrage und die Bedürfnisse unserer Kunden legen wir besonderen Wert auf die Entwicklung von allen Produktkategorien.

- MECHANISCHE WERKZEUGE
- DRUCKLUFT-WERKZEUGE
- KFZ-WERKZEUGE
- WERKSTATTWERKZEUGE
- WERKZEUGE FÜR ELEKTRIKER
- WERKZEUGE FÜR KLEMPNER
- BAUWERKZEUGE
- MESSGERÄTE
- SCHNEIDWERKZEUGE
- ANSCHLUSSWERKZEUGE
- ELEKTROWERKZEUGE
- ZUBEHÖR FÜR WERKZEUGKASTEN

Wir laden Sie ein, sich mit dem HÖGERT WORKWEAR Sortiment vertraut zu machen. Die Kollektionen für Arbeitsschutz- und Sicherheitskleidung, Schuhe und Zubehör sind Produkte, die sich gegenseitig ergänzen und für einen angemessenen Körperschutz unerlässlich sind.



Hand tools of the most demanding users

We provide valuable solutions, combining durability and functionality. Our products are created for demanding users and intensive use. The Höfert Technik brand offer is addressed to professionals who use hand tools in their daily work.

Customer satisfaction is our priority. We guarantee:

- Assistance in choosing an assortment;
- Fast execution of orders;
- Efficient logistics;
- Full marketing support.



EXTENDED WARRANTY

We provide a 25-year or lifetime warranty for selected Höfert Technik tool kits and products. The warranty is valid in the European Union and covers manufacturing and material defects revealed during the warranty period.

QUALITY CONTROL

Höfert Technik products meet the most important quality standards. Quality is the superior value of the Höfert Technik brand. Our products go through a series of tests and external audits before they go on sale. We are constantly looking for new solutions that make work easier for users – raising the bar for ourselves and the competition.



DEMO-CAR – A MOBILE SHOWROOM

The multifunctional brand platform provides free presentations and training on the Höfert Technik tool range: shows, product tests, tips, contests with prizes.

B2B PLATFORM FOR DISTRIBUTORS

Allows fast and intuitive shopping and full access to the product offer 24 hours a day, 7 days a week, without geographical restrictions.

Through the B2B platform, we provide access to current prices and inventory, product photos, data sheets and detailed information about the products, order fulfilment status and commercial documents.

API - automated data exchange

In order to improve the work of our business partners, we provide the integration of stores and websites with the central database of Höfert Technik products.

Social Media - Always be up to date!

Our activity on Facebook and YouTube includes current information about the brand's life, as well as about new products, advice and presentations of selected products from the product range.



INFLUENCER MARKETING and SPORTS MARKETING

We strive to make the Höfert Technik brand recognizable on the domestic and international markets, e.g. through the cooperation with influencers or sports games sponsorship.

SOCIAL RESPONSIBILITY

From the beginning of our activity, we assume the need to promote technical competitions and support local organizations.

This is why we are involved in events that promote specialized schools, the purpose of which is to inform about the labour market for specialized industries. We support leading nationwide competitions for young professionals and numerous educational fairs. We support organizations that work for the benefit of society, by providing tools that make their daily functioning easier.

PRODUCT CATEGORIES

The brand's portfolio is constantly expanding every year. In response to the market needs and our clients, we put special emphasis on the development of each category.

- MECHANICAL TOOLS
- PNEUMATIC TOOLS
- AUTOMOTIVE TOOLS
- WORKSHOP TOOLS
- TOOLS FOR ELECTRICIANS
- TOOLS FOR PLUMBERS
- BUILDING TOOLS
- MEASURING TOOLS
- CUTTING TOOLS
- JOINING TOOLS
- POWER TOOLS
- TOOL STORAGE

We encourage you to look at the HÖGERT WORKWEAR offer. Collections of footwear and OHS accessories are complementary products that are necessary for the proper protection of the body.

Hand tools of the most demanding users

Nous fournissons des solutions à valeur ajoutée alliant durabilité et fonctionnalité. Nos produits sont conçus pour des utilisateurs exigeants et un usage intensif. L'offre de la marque Högert Technik est principalement adressée aux professionnels, aux personnes qui utilisent professionnellement l'outillage à main dans leur travail quotidien.

La satisfaction client est une priorité pour nous. Nous garantissons:

- Assistance pour le choix des assortiments de produits;
- Réalisation rapide des commandes;
- Logistique efficace;
- Support marketing complet.

ALLONGEMENT DE LA PÉRIODE DE GARANTIE

Nous offrons une garantie à vie ou de 25 ans sur certains ensembles d'outils et produits Högert Technik. La garantie est valable dans l'Union européenne et couvre les défauts de fabrication et de matériaux révélés pendant la période de garantie.



CONTRÔLE DE LA QUALITÉ

Les produits högert technik répondent aux normes de qualité les plus importantes.

La qualité est une valeur fondamentale de la marque Högert Technik. Nos produits subissent une série de tests et de contrôles externes avant leur mise en vente. Nous sommes constamment à la recherche de nouvelles solutions pour faciliter le travail des utilisateurs de nos outils – ce qui nous permet de nous surpasser nous-mêmes ainsi que nos concurrents.



PLATE-FORME D'EXPOSITION MOBILE

La plate-forme de marque multifonctionnelle propose des présentations et des formations gratuites sur l'offre d'outils Högert Technik: présentations, tests de produits, conseils, concours avec prix.

PLATEFORME B2B POUR LES DISTRIBUTEURS

Il permet des achats rapides et intuitifs ainsi qu'un accès complet à l'offre des produits 24 h / 24 h, 7 j / 7 j, sans aucune restriction géographique.

A travers la plateforme B2B nous assurons l'accès aux: prix courants et inventaires, photos des produits, fiches de catalogue et informations détaillées sur les produits, état d'exécution des commandes et documents commerciaux.

API - échange de données automatisé

Afin d'améliorer le travail de nos partenaires commerciaux, nous assurons l'intégration des magasins et des sites Internet avec la base de données centrale des produits Högert Technik.

SOCIAL MEDIA – Soyez toujours au courant!



Notre activité dans les réseaux sociaux Facebook et YouTube comprend des informations actuelles sur la vie de la marque, sur les nouveaux produits, ainsi que des conseils et des présentations de produits sélectionnés dans l'offre.



INFLUENCER MARKETING et MARKETING SPORTIF

Nous travaillons à rendre la marque Högert Technik reconnaissable sur le marché national et à l'étranger, en coopérant entre autres avec des suiveurs ou sponsorisant des jeux sportifs.

RESPONSABILITÉ SOCIALE

Dès le début de notre activité nous voyons la nécessité de promouvoir les professions techniques et de supporter les organisations locales.

C'est pourquoi nous voyons engagés dans des événements qui promeuvent les écoles professionnelles et qui mettent au courant le public sur le marché de travail pour les secteurs spécialisés. Nous supportons les concours nationaux pour les jeunes techniciens et menuisiers en de technologie de bois ainsi que de nombreux autres événements éducatifs. Nous soutenons aussi les organisations qui travaillent pour le bien de la société, en leur fournissant des outils qui facilitent leur travail quotidien.

CATÉGORIES DE PRODUITS

Le portfolio de la marque est constamment élargie. En répondant aux besoins du marché et de nos clients, nous accordons une importance particulière au développement constant au sein de chaque catégorie.

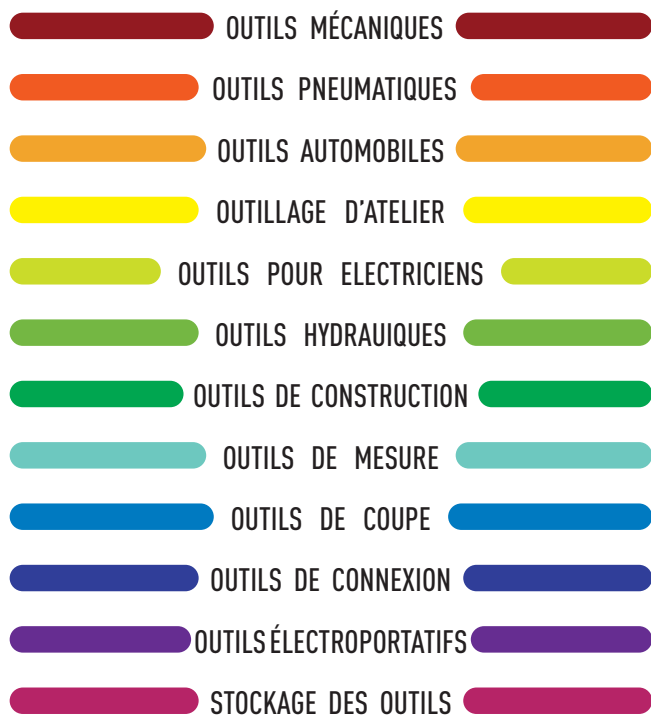

Nous vous invitons à découvrir l'offre de HÖGERT WORKWEAR. Les collections de vêtements et d'accessoires de santé et de sécurité ce sont des produits complémentaires nécessaires pour assurer une bonne protection du corps.

Hand tools of the most demanding users

Aportamos soluciones valiosas que combinan durabilidad y funcionalidad. Nuestros productos están diseñados para usuarios exigentes y un uso intensivo. La oferta de la marca Högert Technik se dirige a profesionales que utilizan herramientas manuales en su trabajo diario.

Satisfacción de los clientes es nuestra prioridad. Garantizamos:

- Asistencia en la elección de productos;
- Rapidez en la ejecución de los pedidos;
- Logística eficaz;
- Completo apoyo comercial.



GARANTÍA AMPLIADA

Ofrecemos una garantía de 25 años o de por vida para los juegos de herramientas y productos seleccionados de Högert Technik. La garantía es válida dentro de la Unión Europea y cubre los defectos de fabricación y de los materiales revelados durante el periodo de garantía.

CONTROL DE CALIDAD

Los productos de högert technik cumplen las más importantes normas de calidad. La calidad es el valor más destacado de nuestra marca. Nuestros productos pasan por una serie de pruebas e inspecciones externas antes de salir a la venta. Buscamos constantemente nuevas soluciones para facilitar el trabajo de los usuarios de las herramientas, elevando el listón para nosotros mismos y para la competencia.



DEMO-CAR COCHE DE DEMOSTRACIÓN

La plataforma multifuncional de la marca ofrece presentaciones y formación gratuitas sobre la gama de herramientas de Högert Technik: demostraciones, pruebas de productos, asesoramiento, concursos con premios.

PLATAFORMA B2B PARA DISTRIBUIDORES

Proporciona una experiencia de compra rápida e intuitiva y un acceso completo a la oferta de productos 24 horas al día, 7 días a la semana y sin limitaciones geográficas.

A través de la plataforma B2B proporcionamos acceso a precios e inventarios actuales, fotos de productos, fichas técnicas e información detallada sobre los mismos, estado de realización de pedidos y documentos comerciales.

API - INTERCAMBIO DE DATOS AUTOMATIZADO

Para hacer más eficaz el trabajo de nuestros socios comerciales, ofrecemos la integración de tiendas y páginas web con la base de datos central de productos de Högert Technik.

REDES SOCIALES – mantente siempre al día!



Nuestra actividad en las plataformas de Facebook e YouTube incluye información actualizada sobre la vida de la marca, así como noticias de productos, consejos y presentaciones de productos seleccionados de la gama.



MARKETING DE INFLUENCER Y MARKETING DEPORTIVO

Trabajamos para que la marca Högert Technik sea reconocible tanto en el mercado nacional como en el extranjero, entre otras cosas, colaborando con influencers o patrocinando competiciones deportivas.

RESPONSABILIDAD SOCIAL

Desde el inicio de nuestra actividad hemos reconocido la necesidad de promover las profesiones técnicas y de apoyar a las organizaciones locales.

Por ello, participamos en eventos que promueven las escuelas técnicas especializadas e informan sobre el mercado laboral de las industrias especializadas. Apoyamos grandes concursos nacionales para jóvenes profesionales y numerosas ferias educativas. Apoyamos a las organizaciones que prestan sus servicios a la comunidad obsequiándoles con herramientas que facilitan sus tareas diarias.

CATEGORÍAS DE PRODUCTOS

La oferta de productos se amplía constantemente de año en año. En respuesta a las demandas del mercado y a las necesidades de nuestros clientes, ponemos especial énfasis en el desarrollo constante dentro de cada categoría.



Échale un vistazo a la oferta de HÖGERT WORKWEAR. Las colecciones de ropa, calzado y accesorios EPI son productos complementarios e imprescindibles para una correcta protección corporal.

Hand tools of the most demanding users

Pružamo vrijedna rješenja, kombinirajući trajnost i funkcionalnost. Naši proizvodi izrađeni su s mišlju o zahtjevnim korisnicima i za intenzivnu upotrebu. Ponuda robne marke Högert Technik upućena je profesionalcima, ljudima koji koriste ručne alate u svakodnevnom radu.

Zadovoljstvo kupaca je naš prioritet. Jamčimo:

- Pomoć u odabiru asortimana;
- Brzu realizaciju narudžbi;
- Učinkovitu logistiku;
- Potpunu marketinška podršku.

PRODULJENO JAMSTVO

Dajemo 25 godina ili doživotno jamstvo za odabrane Högert Technik alate i proizvode. Jamstvo vrijedi na teritoriju Europske unije i pokriva proizvodne i materijalne nedostatke otkrivene tijekom jamstvenog razdoblja.



KONTROLA KVALITETE

Proizvodi högert technik odgovaraju najvažnijim standardima kvalitete.

Kvaliteta je glavna vrijednost naše marke. Naši proizvodi prolaze kroz niz vanjskih ispitivanja i kontrola prije nego što se stave u ponudu. Stalno tražimo nova rješenja koja će olakšati rad korisnicima alata - podižući ljestvicu za sebe i konkurenciju.



DEMO-CAR MOBILNI SHOWROOM

Multifunkcionalna platforma marke nudi besplatne prezentacije i edukacije o ponudi alata Högert Technik: prezentacije, tesiranje proizvoda, savjeti, nagradne igre.

B2B PLATFORMA ZA DISTRIBUTERE

Omogućuje brzu i intuitivnu kupnju i puni pristup ponudi proizvoda 24 sata dnevno, 7 dana u tjednu, bez ograničenja. Putem B2B platforme pružamo pristup trenutnim cijenama i zalihama, fotografijama proizvoda, kataloškim karticama i detaljnim informacijama o proizvodima, statusu realizacije narudžbe i prodajnim dokumentima.

API - AUTOMATSKA RAZMJENA PODATAKA

Kako bismo poboljšali rad naših poslovnih partnera, pružamo integraciju trgovina i web stranica s centralnom bazom podataka o proizvodima Högert Technik.

SOCIAL MEDIA - Uvijek budite u toku!

Naše aktivnosti na Facebook i YouTube platformama uključuju trenutne informacije iz života marke, kao i vijesti o proizvodima, savjete i prezentacije odabranih proizvoda iz ponude.



INFLUENCER MARKETING I SPORTSKI MARKETING

Radimo na tome da marka Högert Technik postane prepoznatljiva na domaćem tržištu i u inozemstvu. Suradujemo s influencerima, sponzoriramo sportske igre.

SOCIJALNA ODGOVORNOST

Od početka naše djelatnosti vidimo potrebu promicanja tehničkih zanata i podrške lokalnim organizacijama.

Zbog toga smo uključeni u događaje koji promoviraju specijalizirane škole i informiraju o tržištu rada za specijalizirane industrije. Podržavamo vodeća državna natjecanja za mlade stručnjake i brojne edukativne sajmove. Podržavamo organizacije koje rade na dobiti društva dajući njima na korištenje alate koji olakšavaju njihov svakodnevni rad.

KATEGORIJE PROIZVODA

Portfelj marke se neprestano proširuje iz godine u godinu. Kao odgovor na potražnju na tržištu i potrebe naših kupaca, poseban naglasak stavljamo na stalni razvoj unutar svake kategorije.



Molimo upoznajte se s ponudom HÖGERT WORKWEAR. Kolekcije odjeće, obuće i dodataka za zaštitu na radu – proizvodi se međusobno nadopunjuju i neophodni su za pravilnu zaštitu tijela na radu.

Hand tools of the most demanding users

Értékes, tartósságot és funkcionalitást ötvöző megoldásokat biztosítunk. Termékeinket a legigényesebb felhasználók számára, intenzív használatot szem előtt tartva tervezzük. A Högert Technik márka termékei a mindennapi munkájuk során kézi szerszámokat használó szakembereknek készültek.

A mi prioritásunk az elégedett ügyfél. Garantáljuk:

- Termék kiválasztásában nyújtott segítség;
- Megrendelések gyors megvalósítása;
- Hatékony logisztika;
- Teljes körű marketingtámogatás.

MEGHOSSZABBÍTOTT GARANCIA

Élettartam vagy 25 év garanciát biztosítunk az egyes szerszámkészletekre és Högert Technik termékekre. A garancia az egész Európai Unió területén érvényes és a garancia időtartama alatt jelentkező gyártási hibákra és anyaghibákra vonatkozik.



MINŐSÉGELLENŐRZÉS

A Högert Technik termékek a legmagasabb minőségi elvárásoknak felelnek meg.

A minőség a Högert Technik márka egyik alapértéke. Termékeink számos vizsgálaton és külső ellenőrzésen esnek át azelőtt, hogy értékesítésre kerüljenek. Szüntelenül olyan új megoldásokat keresünk, melyek megkönnyítik a szerszám felhasználójának munkáját - ezáltal magasabbra helyezve a léceztés munkára és a konkurencia számára.



DEMO-CAR – MOBIL SHOWROOM

Multifunkciós platform ingyenes prezentációt és oktatást tesz lehetővé a Högert Technik kínálatával kapcsolatban: prezentációk, termékteszt, tippek, nyereményjátékok.

B2B DISZTRIBÚTORI PLATFORM

Lehetővé teszi termékeink gyors és intuitív megvásárlását és teljes hozzáférést biztosít a kínálatunkhoz a nap 24 órájában, földrajzi korlátozások nélkül.

A B2B platformon keresztül a következő információkhoz biztosítunk hozzáférést: aktuális árak és raktárkészlet, termékfotók, termékadatlapok és részletes termékinformációk, a megrendelés teljesítésének státusza és kereskedelmi dokumentumok.

API - automatizált adatcsere

Üzleti partnereink munkájának javítása érdekében hozzáférést biztosítunk a webáruházak és weboldalak részére a Högert Technik cég központi termékdatabázisához.

KÖZÖSSÉGI MÉDIA - Legyél naprakész!

A márkával kapcsolatos naprakész információkkal, valamint az új termékeinkkel és egyes termékekkel kapcsolatos tanácsokkal és bemutatókkal szolgálunk a Facebook és YouTube platformokon.



INFLUENCER MARKETING és SPORT MARKETING

Jelentős erőfeszítéseket teszünk azért, hogy a hazai piacon és külföldön is felismerhetővé tegyük a Högert Technik márkát, többek között influencerekkel együttműködve vagy sportversenyek szponzorálásával.

TÁRSADALMI FELELŐSSÉGVÁLLALÁS

Üzleti tevékenységünk kezdete óta tisztában vagyunk a műszaki szakmák népszerűsítésének és a helyi szervezetek támogatásának fontosságával. Ezért számos olyan rendezvényen részt veszünk, amelyek népszerűsítik a szakpariskolákat, és tájékoztatnak a szakosodott iparágak munkaerőpiacáról. Támogatjuk azokat a legfontosabb országos versenyeket amelyek fiatal szakemberek számára rendeznek, valamint egyéb oktatási eseményeket. Segítünk számos önkéntes szervezetet, mint például az Önkéntes Tűzoltókat, ezzel is megkönnyítve a mindennapi működésüket.

TERMÉKKATEGÓRIÁK

A márka kínálata évről évre bővül. Vásárlóink és a piac igényeire reagálva különös hangsúlyt fektetünk az egyes kategóriákon belüli folyamatos fejlődés érdekében.



Szíves figyelmükbe ajánljuk a HÖGERT WORKWEAR termékínálatát. A munkavédelmi ruházat, lábbeli- és tartozék kollekciók olyan kiegészítő termékek, amelyek elengedhetetlenek a test megfelelő védelméhez.

Hand tools of the most demanding users

Oferim soluții valoroase, combinând durabilitatea și funcționalitatea. Produsele noastre sunt create pentru utilizatorii exigenți și folosință intensă. Oferta mărcii Högert Technik se adresează profesioniștilor, persoanelor care folosesc în munca lor profesională de zi cu zi unelte de mână.

Prioritatea noastră este satisfacția clientului. Garantăm:

- Asistență în selectarea sortimentului;
- Realizare rapidă a comenzilor;
- Logistică eficientă;
- Suport complet de marketing.



GARANȚIE PRELUNGITĂ

Oferim o garanție pe viață sau de 25 de ani pentru trusele și produsele Högert Technik selectate. Garanția este valabilă în Uniunea Europeană și acoperă defectele de fabricație și a materialelor detectate în perioada de garanție.

CONTROLUL CALITĂȚII

Produsele Högert Technik îndeplinesc cele mai importante standarde de calitate. Calitatea reprezintă valoarea superioară a brandului Högert Technik. Produsele noastre trec printr-o serie de teste și controale externe înainte de a intra în vânzare. Căutăm în mod constant soluții noi care să ușureze munca utilizatorilor - ridicând ștacheta atât pentru noi înșine cât și pentru concurență.



DEMO CAR - UN SHOWROOM MOBIL

Platforma de brand multifuncțională oferă prezentări gratuite și instruire cu privire la oferta de unelte Högert Technik: prezențații, teste de produs, sfaturi, concursuri cu premii.

PLATAFORMA B2B PENTRU DISTRIBUITORI

Oferă comenzi rapide și intuitive, acces complet la oferta de produse 24/24, 7 zile pe săptămână, fără restricții geografice.

Prin intermediul platformei B2B, oferim acces la: prețuri curente și stocuri; fotografii de produse, fișe tehnice și informații detaliate despre produse; statutul de implementare a comenzilor și documente comerciale.

API - schimb automat de date

Pentru a îmbunătăți activitatea partenerilor noștri de afaceri, oferim integrarea magazinelor și a site-urilor web cu baza de date centrală a produselor Högert Technik.

REȚELE SOCIALE - Fii mereu la curent!

Activitatea noastră pe platformele Facebook și YouTube includ informații actuale despre viața mărcii, precum și despre produse noi, precum și sfaturi și prezentări ale produselor selectate din ofertă.



INFLUENCER MARKETING și MARKETING SPORTIV

Lucrăm pentru ca marca Högert Technik să fie recunoscută pe piața internă și în străinătate, printre altele, cooperând cu influențatori sau sponsorizând jocuri sportive.

RESPONSABILITATE SOCIALĂ

De la începutul activității noastre, vedem necesitatea de a promova competițiile tehnice și a sprijini organizațiile locale. De aceea, ne angajăm în evenimente care promovează școlile de profil și informează despre piața muncii pentru industriile specializate. Susținem competiții la nivel național pentru tineri tehnicieni în tehnologia lemnului și tâmplari și numeroase târguri educaționale. Susținem organizațiile care lucrează în beneficiul societății oferind instrumente care le ușurează funcționarea zilnică.

CATEGORII DE PRODUSE

Portofoliul brandului este în mod constant extins din an în an. Ca răspuns la nevoile pieței și ale clienților noștri, punem un accent deosebit pentru dezvoltare constantă în cadrul fiecărei categorii.

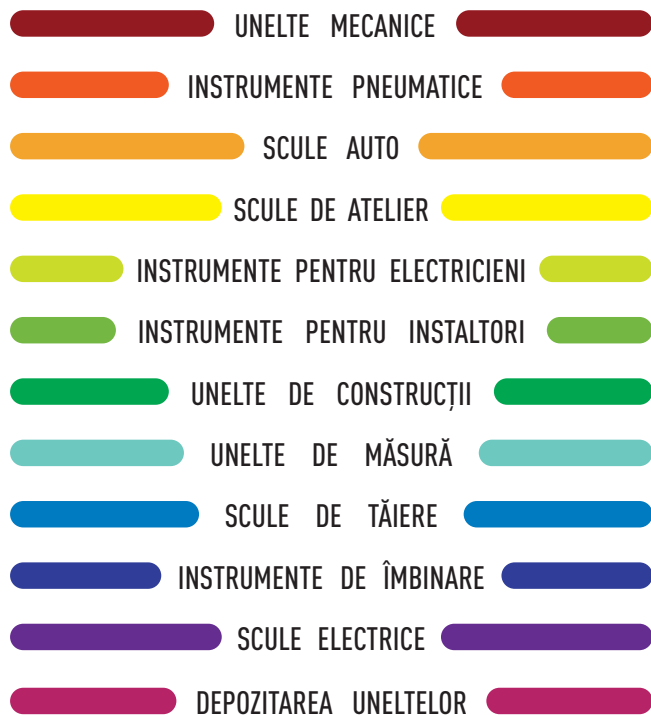

Vă încurajăm să vă familiarizați cu oferta HÖGERT WORKWEAR. Colecțiile de îmbrăcăminte, încălțăminte și accesorii pentru securitate și sănătate în muncă - SSM sunt produse complementare care sunt esențiale pentru o protecție adecvată a corpului.

Hand tools of the most demanding users

Ние предлагаме ценни решения, съчетаващи издръжливост и функционалност.

Нашите продукти са проектирани за вискателни потребители и интензивна употреба. Офертата на марката Höger Technik е адресирана до професионалисти, хора, които професионално използват ръчни инструменти в ежедневната си работа.

Удовлетворението на клиентите е наш приоритет. Гарантираме:

- Помощ при избора на асортимент;
- Бързо изпълнение на поръчки;
- Ефективна логистика;
- Пълна маркетингова поддръжка.



РАЗШИРЕНА ГАРАНЦИЯ

Ние предоставяме 25-годишна или доживотна гаранция за избрани комплекти инструменти и продукти на Höger Technik. Гаранцията е валидна в Европейския съюз и обхваща производствени и материални дефекти, разкрити по време на гаранционния период.

КОНТРОЛ НА КАЧЕСТВОТО

Продуктите на Höger Technik отговарят на най-важните стандарти за качество.

Качеството е най-важната стойност на нашата марка. Нашите продукти преминават поредица от външни тестове и проверки, преди да бъдат продадени. Ние непрекъснато търсим нови решения, които да улеснят работата на потребителите на инструменти - повдигане на летвата за нас и конкуренцията.



АВТОМОБИЛЕН SHOWROOM

Мултифункционалната платформа на марката предлага безплатни презентации и обучения относно предлаганите инструменти на Höger Technik: шоу, тестове на продукти, съвети, състезания с награди.

B2B ПЛАТФОРМА ЗА ДИСТРИБУТОРИ

Тя осигурява бързо и интуитивно пазаруване и пълен достъп до продуктовата оферта 24 часа в денонощието, 7 дни в седмицата, без географски ограничения.

Чрез B2B платформата ние предоставяме достъп до текущи цени и инвентар, снимки на продукти, каталожни карти и подробна информация за продуктите, както и състоянието на изпълнение на поръчките и търговски документи.

API - автоматизиран обмен на данни

За да подобрим работата на нашите бизнес партньори, ние осигуряваме интегрирането на магазини и уебсайтове с централната база данни с продуктите на Höger Technik.

SOCIAL MEDIA - БЪДЕТЕ В ЧАС

Нашата дейност във Facebook и YouTube платформи включва актуална информация за марката, нови продукти, както и съвети и презентации на избрани продукти от офертата.



INFLUENCER МАРКЕТИНГ и СПОРТЕН МАРКЕТИНГ

Работим, за да направим марката Höger Technik разпознаваема на вътрешния пазар и в чужбина, затова сътрудничим с влиятелни лица или сме спонсор на спортни игри.

СОЦИАЛНА ОТГОВОРНОСТ

От началото на нашата дейност виждаме необходимостта от насърчаване на техническите професии и подкрепа на местните организации. Защото участваме в събития, които популяризират технически училища и подкрепяме пазара на труда. Спонсорираме водещи национални състезания за млади специалисти и множество образователни панаири. Ние подкрепяме организациите, работещи в полза на обществото, като предоставяме инструменти, които улесняват ежедневното им функциониране.

ПРОДУКТОВИ КАТЕГОРИИ

Портфолиото на марката постоянно се разширява. В отговор на нужди на пазара и нашите клиенти, ние поставяме особен акцент върху постоянното развитие във всяка категория.

- МЕХАНИЧНИ ИНСТРУМЕНТИ
- ПНЕВМАТИЧНИ ИНСТРУМЕНТИ
- АВТОМОБИЛНИ ИНСТРУМЕНТИ
- РАБОТНИ ИНСТРУМЕНТИ
- ИНСТРУМЕНТИ ЗА ЕЛЕКТРОТЕХНИЦИ
- ИНСТРУМЕНТИ ЗА ВОДОПРОВОДЧИК
- СТРОИТЕЛНИ ИНСТРУМЕНТИ
- ИЗМЕРВАЩИ ИНСТРУМЕНТИ
- РЕЖЕЩИ ИНСТРУМЕНТИ
- СВЪРЗВАЩИ ИНСТРУМЕНТИ
- ЕЛЕКТРИЧЕСКИ ИНСТРУМЕНТИ
- СЪХРАЯВАНЕ НА ИНСТРУМЕНТИ

Препоръчваме Ви да се запознаете с офертата на HÖGERT WORKWEAR. Предлагаме дрехи и обувки за работа и защита на тялото. В нашата оферта предлагаме аксесоари, които са част и необходимост за защита на тялото и безопасността на работното Ви място.



DE Mechanische Werkzeuge **EN** Mechanical Tools **FR** Outils Mécaniques **ES** Herramientas Mecánicas **HR** Mehanički Alati
HU Mechanikus Szerszámok **RO** Unelte Mecanice **BG** Механични Инструменти



HT1R490 46



HT1R478 46



HT1R478 46



HT1R480 47



HT1R464 47



HT1R491 47



HT1R465 48



HT1R466 48



HT1R462 48



HT1S405 49



HT1S404 49



HT1R416 49



HT1R485 50



HT1R470 50



HT1R486 50



HT1R425 51



HT1R424 51



HT1R450 52



HT1R426 52



HT1R454 53



HT1R432 53



HT1R439 55



HT1R440 56



HT1R458 57



HT1R444 58



HT1R332 59



HT1R334 59



HT1R382 59



HT1R395 59

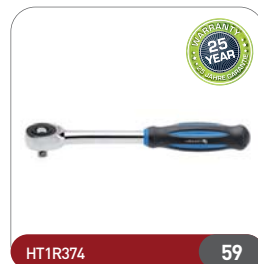

HT1R374 59



HT1R304 59



HT1R324 59



HT1R354 59



HT1R342 61



HT1R391 60



HT1W701 61



HT1W710 61



HT1W879 61



HT1S203 61



HT1A701 61



HT1A714 61



HT1A724 62



HT1A740 62



HT1A792 62



HT1A745 62



HT1A763 62



HT1A755 62



HT1A770 62



HT1A002 62



HT1A156 63



HT1A208 63



HT1A258 63



HT1A408 63



HT1A779 64



HT1A783 64



HT1A886 64



HT1A888 64



HT1A884 64



HT1A880 64



HT1A752 64



HT1S601 64



HT1S606 65



HT1S623 65



HT1S640 65



HT1S670 65



HT1S724

65



HT1S746

65



HT1S785

65



HT1S524

65



HT1S546

66



HT1S585

66



HT1S401

66



HT1S400

66



HT1S402

66



HT1R460

66



HT1R461

66



HT1S438

66



HT1S439

67



HT1S440

67



HT1S441

67



HT1S445

67



HT1S442

67



HT1S446

67



HT1S457

67



HT1S432

67



HT1S305

69



HT1S300

69



HT1S304

69



HT1S382

69



HT1S307

69



HT1S317

69



HT1S384

69



HT1S330

69



HT1S361

70



HT1S334

70



HT1S343

70



HT1S347

70



HT1S359

70



HT1S323

70



HT1S392

70



HT1S313

70



HT1S324

71



HT1S322

71



HT1S395

71



HT1S846

71



HT1S885

71



HT1S120

71



HT1S125

71



HT1S130

71



HT1S135

72



HT1S145

72



HT1S150

72



HT1S155

72



HT1S160

72



HT1S165

72



HT1S175

72



HT1W802

72



HT1W801

73



HT1W803

73



HT1W800

73



HT1W807

73



HT1W804

73



HT1W808

73



HT1W814

73



HT1W818

73



HT1W809

74



HT1W810

74



HT1W820

74



HT1W821

74



HT1W822

74



HT1W825

74



HT1W826

74



HT1W830

74



HT1W831

75



HT1W816

75



HT1W806

75



HT1W817

75



HT1S272

75



HT1S270

75



HT1S271

75



HT1S094

75



HT1S095

76

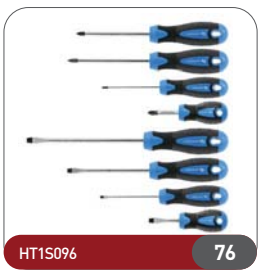

HT1S096

76



HT1S097

76



HT1S098

76



HT1S100

76



HT1S101

76



HT1S215

76



HT1S216

76



HT1S105

77



HT1S099

77



HT1S201

79



HT1S001

79



HT1S020

79



HT1S040

79



HT1S051

79



HT1S064

79



HT1S072

79



HT1S077

79



HT1S214

80



HT1S986

80



HT1S990

80



HT1S994

80



HT1S996

80



HT1S997

80



HT1S998

80



HT1S902

80



HT1S960

81



HT1S920

81



HT1S965

81

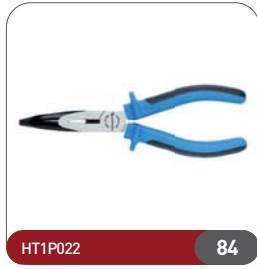

DE Druckluft-Werkzeuge **EN** Pneumatic Tools **FR** Outils Pneumatiques **ES** Herramientas Neumáticas **HR** Pneumatski Alati
HU Pneumatikus Szerszámok **RO** Instrumente Pneumatice **BG** Пневматични Инструменти



HT4R621 88



HT4R622 88



HT4R623 88



HT4R625 88



HT4R630 88



HT4R650 88



HT4R635 88



HT4R651 88



HT4R652 89



HT4R006 89



HT4R010 89



HT4R049 89



HT4R104 89



HT4R111 89



HT4R211 89



HT4R302 89



HT4R315 90



HT4R320 90



HT4R324 90



HT4R326 90



HT4R328 90



HT6R002 90



HT6R004 90



HT6R006 90



HT4R712 91



HT4R718 91



HT4R716 91



HT4R746 91



HT4R748 91



HT4R750 91



HT4R751

91

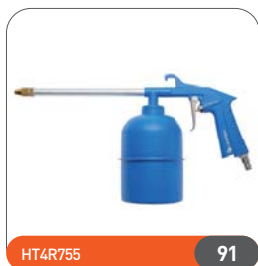

HT4R755

91



HT4R757

92

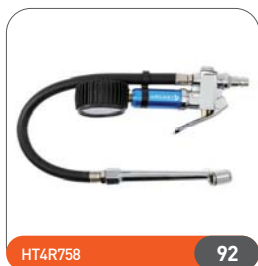

HT4R758

92



HT4R801

HT4R802

HT4R803

HT4R804

HT4R801

92



HT4R810

HT4R811

HT4R812

HT4R813

HT4R810

92



HT4R820

92



HT4R821

92



HT4R870

92



HT4R871

HT4R872

HT4R871

92



HT4R873

93



HT4R874

93



HT4R875

93



HT4R876

93



HT4R890

93



HT4R897

93

DE KFZ-Werkzeuge EN Automotive Tools FR Outils Automobiles ES Herramientas De Automoción HR Alati Za Automobile HU Járműipari Szerszámok RO Scule Auto BG Автомобилни Инструменти



HT8G004

96



HT8G006

96



HT8G022

96



HT8G052

96



HT8G100

96



HT8G200

96



HT8G205

96



HT8G210

96

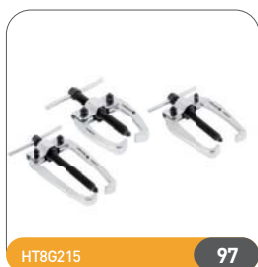

HT8G215

97



HT8G218

97



HT8G225

97



HT8G227

97



HT8G229

97



HT8G230

97



HT8G231

97



HT8G240

97



HT8G245

99



HT8G246

99



HT8G247

99

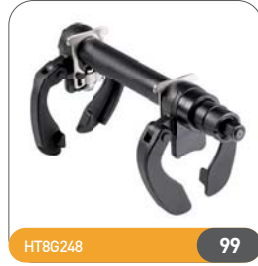

HT8G248

99



HT8G250

99



HT8G251

99



HT8G252

99



HT8G253

99



HT8G254

100



HT8G257

100



HT8G258

100



HT8G301

100



HT2E200

100



HT2E210

100



HT8G306

100



HT8G307

102



HT8G305

102



HT8G310

102



HT8G311

102



HT8G314

102



HT8G315

102



HT8G317

102



HT8G318

103



HT8G320

103



HT8G321

103



HT8G322

103



HT8G323

103



HT8G324

103



HT8G325

103



HT8G326 103



HT8G327 104



HT8G328 104



HT8G329 104



HT8G330 104



HT8G340 104



HT8G341 104



HT8G342 104



HT8G343 104



HT8G344 105



HT8G345 105



HT8G346 105



HT8G347 105



HT8G348 105



HT8G349 105



HT4R781 105



HT8G360 105



HT8G361 106



HT8G362 106



HT8G363 106



HT8G364 106



HT8G370 106



HT8G371 106



HT8G372 106



HT8G373 106



HT8G374 107



HT4R780 107

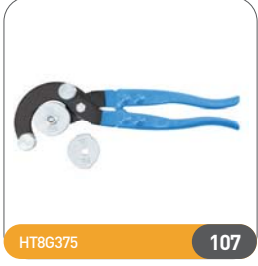

HT8G375 107



HT8G376 107



HT8G390 107



HT8G391 107



HT8G392 107



HT8G393 107



HT8G394 108



HT8G400 108



HT8G401 108



HT8G402 108



HT8G403 108



HT8G404 108



HT8G405 108



HT8G406 108



HT8G410 109



HT8G411 109



HT8G412 109



HT8G413 109



HT8G414 109



HT8G415 109



HT8G416 109



HT8G418 109



HT8G419 111



HT8G420 111



HT8G421 111



HT8G422 111



HT8G423 111



HT8G426 111



HT8G427 111



HT8G428 111



HT8G429 112



HT8G430 112



HT8G431 112



HT8G432 112



HT8G433 112



HT8G434 112



HT8G435 112



HT8G436 112



HT8G437 113



HT8G460 113



HT8G500 113



HT8G501 113



HT8G502 113



HT8G503

113



HT8G504

113



HT8G505

113



HT8G506

114



HT8G507

114



HT8G508

114



HT8G509

114



HT8G510

114



HT8G511

114



HT8G512

114



HT8G513

114



HT8G514

115



HT8G515

115



HT8G516

115



HT8G517

115



HT8G550

115



HT8G551

115



HT8G552

115



HT8G553

115



HT8G554

116



HT8G555

116



HT8G556

116



HT8G557

116



HT8G558

116



HT8G559

116



HT8G560

116



HT8G561

116



HT8G601

117



HT8G610

117



HT8G611

117



HT8G613

117



HT8G614

117



HT8G616

117



HT8G620

117



HT8G904

117



HT8G905

119



HT8G907

119



HT8G908

119



HT8G912

119



HT8G913

119



HT4R790

119



HT4R795

119



HT8G915

119



HT8G920

120



HT8G925

120



HT8G930

120



HT8G935

120



HT8G936

120



HT8G937

120



HT8G940

120



HT8G945

120



HT8G946

121

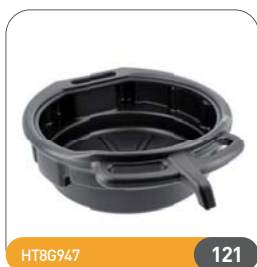

HT8G947

121

DE Werkstattwerkzeuge EN Workshop Tools FR Outillage D'Atelier ES Herramientas De Taller HR Alati Za Radionice HU Műhelyszerszámok RO Scule De Atelier BG Работни Инструменти



HT1E402

124



HT1E406

124



HT1E407

124



HT1E408

124

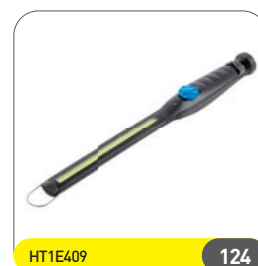

HT1E409

124



HT1E410

124



HT1E420

124



HT1E424

124



HT1E425

125



HT1E430

125



HT4R502 125



HT4R504 125



HT4R506 125



HT4R508 125



HT4R509 125

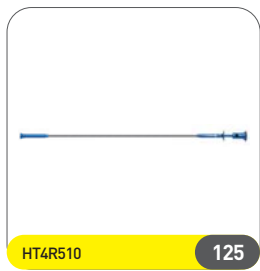

HT4R510 125



HT4R512 126



HT4R522 126



HT4R520 126



HT4R521 126



HT4R518 126



HT4R519 126

DE Werkzeuge Für Elektriker **EN** Tools For Electricians **FR** Outils Pour Electriciens **ES** Herramientas Para Electricistas **HR** Alati Za Električare **HU** Villanyszerelési Szerszámok **RO** Instrumente Pentru Electricieni **BG** Инструменти За Електротехници



HT1E602 130



HT1E603 130



HT1E605 130



HT1E615 130



HT1E600 130



HT1E601 130



HT1E606 130



HT1E604 130



HT1E620 131



HT1E621 131



HT1E640 131



HT1S982 131



HT1S981 131



HT1E630 131



HT1P903 131



HT1P909 131

HT1P913 132

HT1P919 132

HT1P931 132

HT1P189 132

HT1P040 132

HT1P047 132

HT1P046 132

HT1P042 132

HT1P048 133

HT1P102 133

HT1P103 133

HT1P186 133

HT1P187 133

HT1P188 133

HT1P181 133

HT1P182 133

HT1P170 134

HT1P172 134

HT1P176 134

HT1P192 134

HT1P160 134

HT1P194 134

HT1P195 134

HT1P161 134

HT1P162 135

HT1P193 135

HT1P190 135

HT1P191 135

HT1P196 135

HT1P198 135

HT1P199 135

HT1P169 135

HT1P281 136

HT1E700 136



HT1E720

136



HT1E735

136

DE Werkzeuge Für Klempner **EN** Tools For Plumbers **FR** Outils Hydrauliques **ES** Herramientas Para Fontaneros **HR** Alati Za Vodoinstalatore **HU** Gépészeti Szerszámok **RO** Instrumente Pentru Instalatori **BG** Инструменти За Водопроводчик

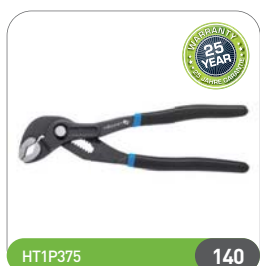

HT1P375

140



HT1P378

140

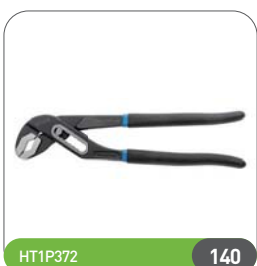

HT1P372

140



HT1P380

140

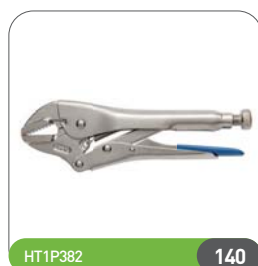

HT1P382

140



HT1P384

140



HT1P501

140



HT1P506

140



HT1P519

141

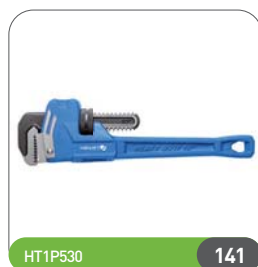

HT1P530

141



HT1P531

141



HT1P541

141



HT1P545

141

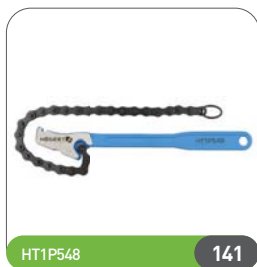

HT1P548

141



HT1P552

141



HT1P560

141



HT1P561

142



HT1P562

142



HT1P564

142



HT1P595

142

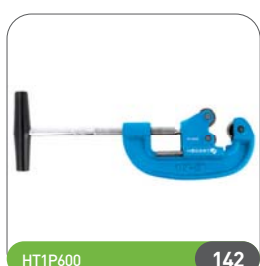

HT1P600

142



HT1P603

142



HT1P617

142



HT1P605

142

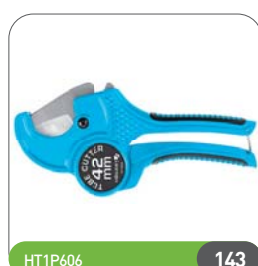

HT1P606

143



DE Bauwerkzeuge EN Building Tools FR Outils De Construction ES Herramientas De Construcción HR Građevinski Alati
 HU Építőipari Szerszámok RO Unelte De Construcții BG Строителни Инструменти

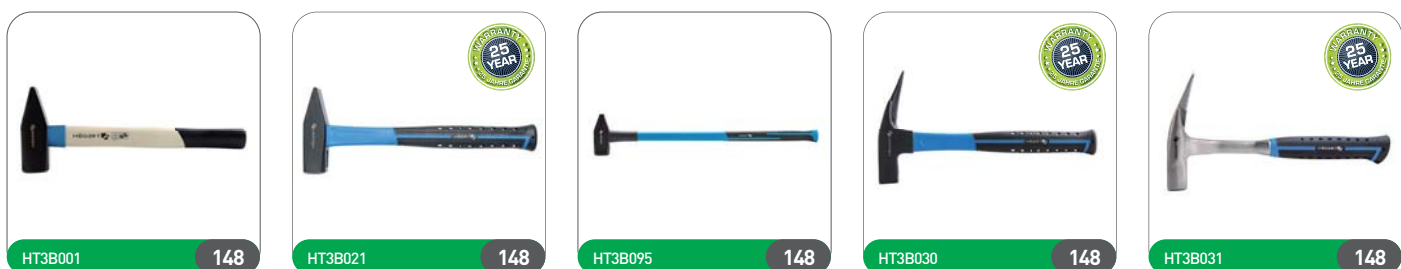

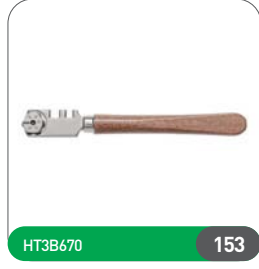
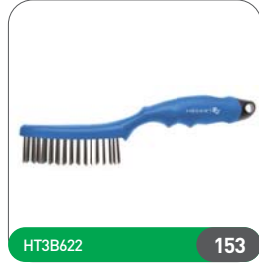
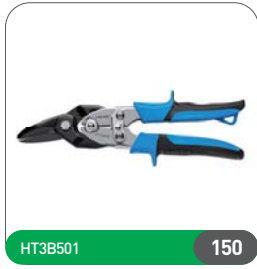
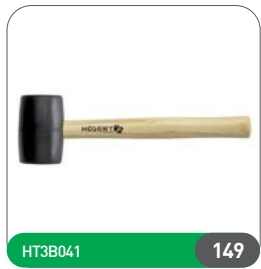



HT3B710

154



HT3B712

154



HT3B713

154

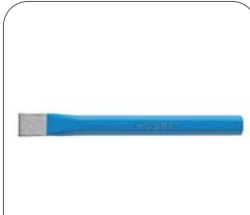

HT3B721

154

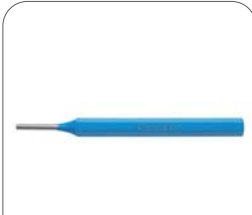

HT3B724

154

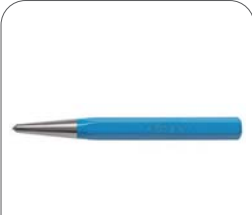

HT3B728

154

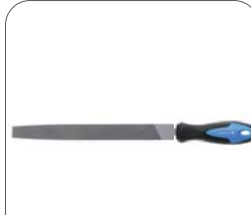

HT3B800

154

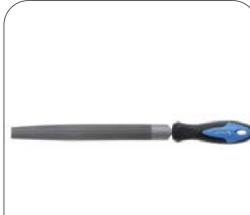

HT3B801

154



HT3B802

155



HT3B804

155



HT3B808

155

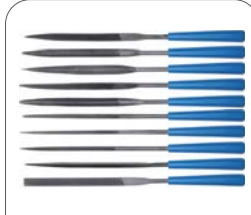

HT3B809

155



HT3B810

155



HT3B811

155



HT3B841

155



HT3B880

155



HT1P350

156



HT1P356

156



HT1P390

156



HT1P392

156



HT1P393

156



HT3B902

156



HT3B911

156



HT3B941

156



HT3B935

157



HT3B944

157



HT3B946

157



HT3B950

157



HT3B960

157



HT3B963

157



HT3S202

157



HT3S232

157



HT3S234

158



HT3S238

158



HT3S270

158



HT3S274-D 158



HT3S277 158



HT3S280 158



HT3S285 158



HT3S295 158



HT3B770 159



HT3B772 159



HT3B771 159



HT3B774 159



HT3B775 159



HT4M218 159



HT3B650 159



HT3B655 159



HT3B660 161



HT3B665 161



HT4R402 161



HT4R405 161



HT4R422 161



HT4R425 161

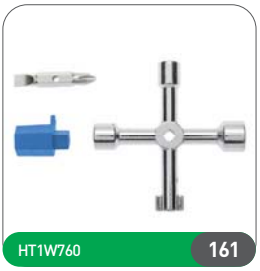

HT1W760 161



HT1W761 161

DE Messgeräte **EN** Measuring Tools **FR** Outils De Mesure **ES** Herramientas De Medición **HR** Mjerni Alati **HU** Mérőszerszámok **RO** Unelte De Măsură **BG** Измерващи Инструменти



HT4M438 164



HT4M437 164



HT4M400 164



HT4M423 164



HT4M426 164



HT4M405

164



HT4M432

164



HT4M435

164



HT4M436

165



HT4M409

165



HT4M429

165



HT4M473

165



HT4M475

165



HT4M476

165



HT4M322

165



HT4M261-D

165



HT4M262

166



HT4M270

166



HT4M274

166



HT4M202

166



HT4M214

166



HT4M215

166



HT4M216

166

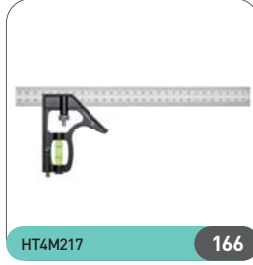

HT4M217

166

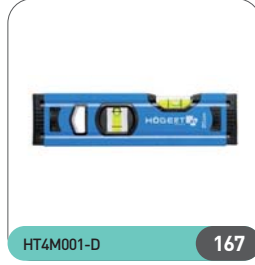

HT4M001-D

167



HT4M040

167



HT4M003

167



HT4M005

167



HT4M006

167

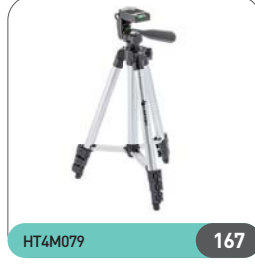

HT4M079

167



HT4M070

167



HT4M071

167



HT4M072

168



HT4M074

168



HT4M340

168



HT4M341

168



HT4M342

168

DE Schneidwerkzeuge **EN** Cutting Tools **FR** Outils De Coupe **ES** Herramientas De Corte **HR** Rezni Alati **HU** Vágóeszközök
RO Scule De Tăiere **BG** Режещи Инструменти



HT7D915 172



HT6D201 172



HT6D370 172



HT6D280 172



HT6D281 172



HT6D284 172



HT6D470 173



HT6D490 173



HT6D476 173



HT6D484 173



HT6D290 173



HT6D291 173



HT6D492 173

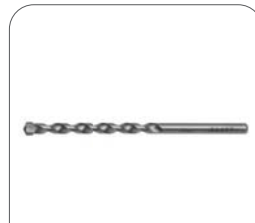

HT6D380 173

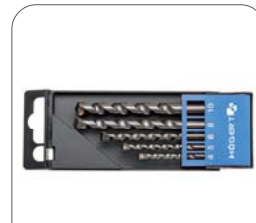

HT6D378 174



HT6D186 174

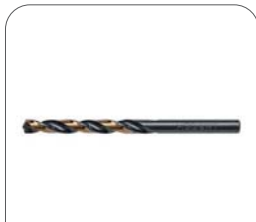

HT6D802 174



HT6D103 174



HT6D180 174



HT6D330 174

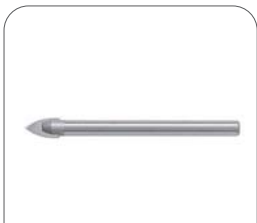

HT6D084 175



HT6D336 175

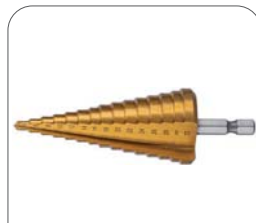

HT6D321 175

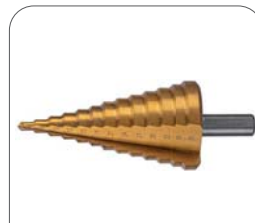

HT6D324 175



HT6D325 175

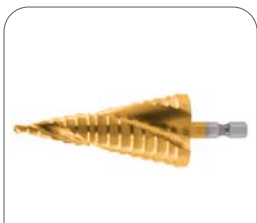

HT6D326 175



HT6D523 175

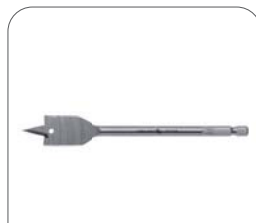

HT7D110 175



HT6D541 177



HT7D158 177



HT6D344

177



HT6D310

177



HT6D504

177



HT3B580

177



HT3B581

177



HT3B582

178



HT6D462

178



HT6D404

178



HT7D270

178



HT7D306

178



HT6D701

178



HT6D711

178



HT6D721

179



HT6D742

179

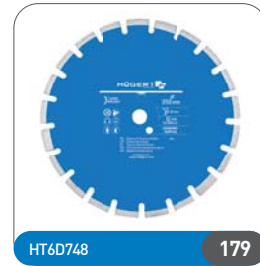

HT6D748

179

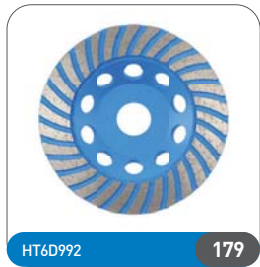

HT6D992

179



HT6D601

179



HT6D631

179



HT6D635

179



HT6D606

179



HT6D640

180

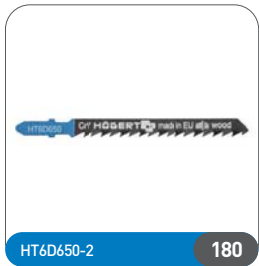

HT6D650-2

180



HT6D651

180



HT6D653

180



HT6D654-2

180



HT6D656-2

180



HT6D657

180



HT6D659

180



HT6D660-2

182



HT6D661-2

182



HT6D663-2

182



HT6D665

182



HT6D666

182



HT6D667

182

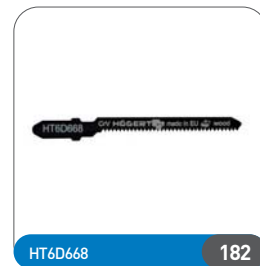

HT6D668

182



HT6D690

182



HT6D682-2

183



HT6D671

183



HT6D672

183



HT6D673

183



HT6D680-2

183



HT6D901

183



HT6D902

183



HT6D904

183

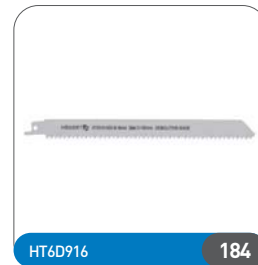

HT6D916

184



HT6D923

184



HT8D001

184



HT8D050

184



HT8D100

184

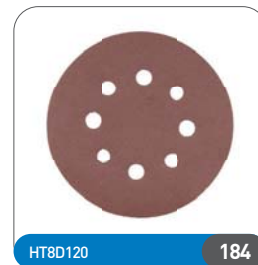

HT8D120

184



HT8D130

184

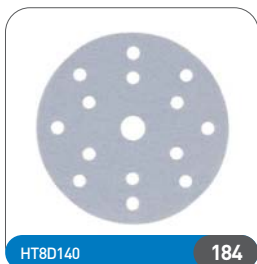

HT8D140

184



HT8D190

185



HT8D195

185



HT8D200

185



HT8D210

185



HT7D702

185



HT7D704

185



HT7D706

185



HT7D712

185



HT7D713

187



HT7D716

187



HT7D722

187



HT7D724

187



HT7D732

187



HT7D734

187



HT7D738

187



HT4C603-D

187



HT4C604

188



HT4C605

188



DE Anschlusswerkzeuge **EN** Joining Tools **FR** Outils De Connexion **ES** Herramientas De Unión **HR** Alati Za Spajanje
HU Rögzítő Eszközök **RO** Instrumente De Îmbinare **BG** Свързващи Инструменти



HT2C101 196



HT2C107 196



HT2C108 196



HT2C131 196



HT2C135 196



HT2C137 196



HT2C138 196



HT2C141 196



HT2C002 197



HT2C004 197



HT2C050 197



HT2C059 197



HT2C152 197



HT2C154 197



HT2C156 197



HT2C180 197



HT2C181 198



HT2C191 198



HT2C301 198



HT2C310 198



HT2C311 198

DE Elektrowerkzeuge **EN** Power Tools **FR** Outils Électroportatifs **ES** Herramientas Eléctricas **HR** Električni Alati
HU Szerszámgépek **RO** Scule Electrice **BG** Електрически Инструменти



HT2C550 202



HT2C551 202



HT2C552 202



HT2E100 202



HT2E101 202



HT2E105 202



HT2E106 203



HT2E130 203



HT2E115 203



HT2E116 203

DE Zubehör Für Werkzeugkasten **EN** Tool Storage **FR** Stockage Des Outils **ES** Almacenamiento De Herramientas
HR Pohrana Alata **HU** Szerszámtárolók **RO** Depozitarea Uneltelor **BG** Съхраняване На Инструменти



HT7G045 206



HT7G046 206



HT7G047 206



HT7G048 206



HT7G049 206



HT7G052 206



HT7G054 207



HT7G055 207



HT7G056 207



HT7G058 207



HT7G059 207



HT7G160 207



HT7G080 208



HT7G081 208



HT7G074 208



HT7G075

208



HT7G077

208



HT7G072

208



HT7G078

209



HT7G010

209



HT7G011

209



HT7G012

209



HT7G018

209



HT7G060

209



HT7G061

210



HT7G063

210



HT7G066

210



HT7G064

210



HT7G065

210



HT7G033

210



HT7G034

211



HT7G022

211



HT7G024

211



HT7G026

211



HT7G120

211



HT7G121

211



HT7G122

212



HT7G123

212



HT7G124

212



HT7G125

212



HT7G126

212



HT7G127

212



HT7G128

213



HT7G129

213



HT7G130

213



HT7G131

213



HT7G132

213



HT7G133

213



HT7G134

214



HT7G135

214

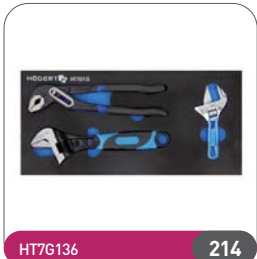

HT7G136 214

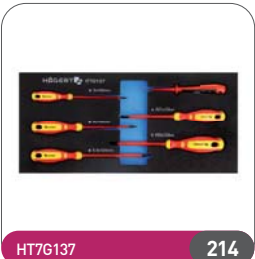

HT7G137 214



HT7G139 214



HT7G141 214



HT7G142 215



HT7G144 215



HT7G145 215



HT7G146 215



HT7G147 215



HT7G149 215



HT7G148 216



HT7G150 216



HT7G151 216

INDEX**HT1**

HT1A002	62	HT1A410	63	HT1P006	83	HT1P392	156	HT1P905	131
HT1A003	62	HT1A411	63	HT1P008	83	HT1P393	156	HT1P907	131
HT1A004	62	HT1A412	63	HT1P010	83	HT1P394	156	HT1P909	131
HT1A005	62	HT1A413	63	HT1P012	83	HT1P501	140	HT1P911	131
HT1A006	62	HT1A414	63	HT1P016	83	HT1P502	140	HT1P913	132
HT1A007	62	HT1A415	63	HT1P020	83	HT1P503	140	HT1P917	132
HT1A008	62	HT1A416	63	HT1P022	84	HT1P506	140	HT1P919	132
HT1A009	62	HT1A417	63	HT1P024	84	HT1P507	140	HT1P923	132
HT1A010	62	HT1A418	63	HT1P026	84	HT1P508	140	HT1P931	132
HT1A011	62	HT1A419	63	HT1P040	132	HT1P519	141	HT1R006	82
HT1A012	62	HT1A420	63	HT1P042	132	HT1P520	141	HT1R007	82
HT1A013	62	HT1A421	63	HT1P044	132	HT1P522	141	HT1R008	82
HT1A014	62	HT1A422	63	HT1P046	132	HT1P524	141	HT1R009	82
HT1A156	63	HT1A423	63	HT1P047	132	HT1P526	141	HT1R010	82
HT1A157	63	HT1A424	63	HT1P048	133	HT1P530	141	HT1R011	82
HT1A158	63	HT1A427	63	HT1P049	133	HT1P531	141	HT1R012	82
HT1A159	63	HT1A430	63	HT1P050	84	HT1P532	141	HT1R013	82
HT1A160	63	HT1A432	63	HT1P052	84	HT1P533	141	HT1R014	82
HT1A161	63	HT1A701	61	HT1P054	84	HT1P534	141	HT1R015	82
HT1A162	63	HT1A702	61	HT1P056	84	HT1P535	141	HT1R016	82
HT1A163	63	HT1A703	61	HT1P058	84	HT1P536	141	HT1R017	82
HT1A164	63	HT1A705	61	HT1P070	84	HT1P537	141	HT1R018	82
HT1A165	63	HT1A714	61	HT1P102	133	HT1P539	141	HT1R019	82
HT1A166	63	HT1A724	62	HT1P103	133	HT1P541	141	HT1R020	82
HT1A167	63	HT1A727	62	HT1P141	85	HT1P542	141	HT1R021	82
HT1A168	63	HT1A740	62	HT1P142	85	HT1P543	141	HT1R022	82
HT1A169	63	HT1A745	62	HT1P143	85	HT1P545	141	HT1R024	82
HT1A170	63	HT1A747	62	HT1P144	85	HT1P546	141	HT1R027	82
HT1A171	63	HT1A752	64	HT1P145	85	HT1P547	141	HT1R030	82
HT1A208	63	HT1A755	62	HT1P146	85	HT1P548	141	HT1R032	82
HT1A209	63	HT1A756	62	HT1P147	85	HT1P552	141	HT1R048	83
HT1A210	63	HT1A757	62	HT1P148	85	HT1P554	141	HT1R050	83
HT1A211	63	HT1A763	62	HT1P160	134	HT1P556	141	HT1R051	83
HT1A212	63	HT1A764	62	HT1P161	134	HT1P560	141	HT1R052	83
HT1A213	63	HT1A770	62	HT1P162	135	HT1P561	142	HT1R053	83
HT1A214	63	HT1A771	62	HT1P169	135	HT1P562	142	HT1R054	83
HT1A215	63	HT1A772	62	HT1P170	134	HT1P563	142	HT1R055	83
HT1A216	63	HT1A773	62	HT1P172	134	HT1P564	142	HT1R056	83
HT1A217	63	HT1A774	62	HT1P176	134	HT1P595	142	HT1R057	83
HT1A218	63	HT1A775	62	HT1P181	133	HT1P600	142	HT1R058	83
HT1A219	63	HT1A779	64	HT1P182	133	HT1P603	142	HT1R059	83
HT1A220	63	HT1A783	64	HT1P186	133	HT1P605	142	HT1R061	83
HT1A221	63	HT1A785	64	HT1P187	133	HT1P606	143	HT1R070	83
HT1A222	63	HT1A792	62	HT1P188	133	HT1P611	143	HT1R071	83
HT1A223	63	HT1A880	64	HT1P189	132	HT1P612	143	HT1R072	83
HT1A224	63	HT1A884	64	HT1P190	135	HT1P614	143	HT1R073	83
HT1A227	63	HT1A886	64	HT1P191	135	HT1P617	142	HT1R074	83
HT1A230	63	HT1A888	64	HT1P192	134	HT1P620	143	HT1R302	59
HT1A232	63	HT1E402	124	HT1P193	135	HT1P623	143	HT1R304	59
HT1A236	63	HT1E406	124	HT1P194	134	HT1P624	143	HT1R308	59
HT1A258	63	HT1E407	124	HT1P195	134	HT1P625	143	HT1R322	59
HT1A259	63	HT1E408	124	HT1P196	135	HT1P626	143	HT1R324	59
HT1A260	63	HT1E409	124	HT1P198	135	HT1P627	143	HT1R328	59
HT1A261	63	HT1E410	124	HT1P199	135	HT1P628	144	HT1R332	59
HT1A262	63	HT1E420	124	HT1P281	136	HT1P630	143	HT1R334	59
HT1A263	63	HT1E424	124	HT1P282	136	HT1P635	144	HT1R342	61
HT1A264	63	HT1E425	125	HT1P283	136	HT1P636	144	HT1R352	59
HT1A265	63	HT1E430	125	HT1P284	136	HT1P637	144	HT1R354	59
HT1A266	63	HT1E600	130	HT1P285	136	HT1P638	144	HT1R372	59
HT1A267	63	HT1E601	130	HT1P286	136	HT1P639	144	HT1R374	59
HT1A268	63	HT1E602	130	HT1P350	156	HT1P640	144	HT1R382	59
HT1A269	63	HT1E603	130	HT1P356	156	HT1P641	144	HT1R391	61
HT1A270	63	HT1E604	130	HT1P358	156	HT1P642	144	HT1R395	59
HT1A271	63	HT1E605	130	HT1P372	140	HT1P643	144	HT1R397	83
HT1A272	63	HT1E606	130	HT1P375	140	HT1P644	144	HT1R416	49
HT1A273	63	HT1E615	130	HT1P376	140	HT1P645	144	HT1R424	51
HT1A274	63	HT1E620	131	HT1P377	140	HT1P650	144	HT1R425	51
HT1A277	63	HT1E621	131	HT1P378	140	HT1P651	144	HT1R426	52
HT1A280	63	HT1E630	131	HT1P379	140	HT1P652	144	HT1R432	53
HT1A282	63	HT1E640	131	HT1P380	140	HT1P653	144	HT1R439	55
HT1A408	63	HT1E700	136	HT1P382	140	HT1P654	144	HT1R440	56
HT1A409	63	HT1E701	136	HT1P384	140	HT1P655	144	HT1R444	58
		HT1E702	136	HT1P385	85	HT1P656	144	HT1R450	52
		HT1E720	136	HT1P386	85	HT1P657	144	HT1R454	53
		HT1E721	136	HT1P387	85	HT1P680	144	HT1R458	57
		HT1E735	136	HT1P390	156	HT1P903	131	HT1R460	66

HT1R461	66	HT1S151	72	HT1S366	70	HT1S673	65	HT1W406	82
HT1R462	48	HT1S152	72	HT1S367	70	HT1S674	65	HT1W407	82
HT1R464	47	HT1S153	72	HT1S382	69	HT1S675	65	HT1W408	82
HT1R465	48	HT1S155	72	HT1S384	69	HT1S676	65	HT1W409	82
HT1R466	48	HT1S156	72	HT1S385	69	HT1S677	65	HT1W410	82
HT1R470	50	HT1S157	72	HT1S386	69	HT1S678	65	HT1W411	82
HT1R478	46	HT1S158	72	HT1S392	70	HT1S679	65	HT1W412	82
HT1R480	47	HT1S160	72	HT1S395	71	HT1S680	65	HT1W413	82
HT1R485	50	HT1S161	72	HT1S400	66	HT1S724	65	HT1W414	82
HT1R486	50	HT1S162	72	HT1S401	66	HT1S725	65	HT1W415	82
HT1R490	46	HT1S165	72	HT1S402	66	HT1S726	65	HT1W416	82
HT1R491	47	HT1S166	72	HT1S404	49	HT1S727	65	HT1W417	82
HT1R492	46	HT1S167	72	HT1S405	49	HT1S728	65	HT1W418	82
HT1S001	79	HT1S168	72	HT1S432	67	HT1S729	65	HT1W419	82
HT1S002	79	HT1S169	72	HT1S438	66	HT1S730	65	HT1W420	82
HT1S004	79	HT1S170	72	HT1S439	67	HT1S731	65	HT1W421	82
HT1S008	79	HT1S171	72	HT1S440	67	HT1S732	65	HT1W422	82
HT1S010	79	HT1S172	72	HT1S441	67	HT1S746	65	HT1W424	82
HT1S012	79	HT1S175	72	HT1S442	67	HT1S747	65	HT1W425	82
HT1S014	79	HT1S176	72	HT1S445	67	HT1S748	65	HT1W426	82
HT1S015	79	HT1S177	72	HT1S446	67	HT1S749	65	HT1W427	82
HT1S020	79	HT1S178	72	HT1S457	67	HT1S750	65	HT1W428	82
HT1S023	79	HT1S201	79	HT1S458	67	HT1S751	65	HT1W430	82
HT1S024	79	HT1S203	61	HT1S459	67	HT1S752	65	HT1W432	82
HT1S028	79	HT1S214	80	HT1S460	67	HT1S753	65	HT1W436	82
HT1S029	79	HT1S215	76	HT1S524	65	HT1S754	65	HT1W441	82
HT1S032	79	HT1S216	76	HT1S525	65	HT1S755	65	HT1W446	82
HT1S040	79	HT1S270	75	HT1S526	65	HT1S785	65	HT1W450	82
HT1S041	79	HT1S271	75	HT1S527	65	HT1S786	65	HT1W455	82
HT1S042	79	HT1S272	75	HT1S528	65	HT1S788	65	HT1W490	83
HT1S051	79	HT1S300	69	HT1S529	65	HT1S790	65	HT1W492	82
HT1S053	79	HT1S301	69	HT1S530	65	HT1S792	65	HT1W496	82
HT1S054	79	HT1S302	69	HT1S531	65	HT1S794	65	HT1W590	81
HT1S055	79	HT1S303	69	HT1S532	65	HT1S796	65	HT1W598	82
HT1S056	79	HT1S304	69	HT1S546	66	HT1S797	65	HT1W599	82
HT1S057	79	HT1S305	69	HT1S547	66	HT1S846	71	HT1W701	61
HT1S058	79	HT1S307	69	HT1S548	66	HT1S847	71	HT1W706	61
HT1S059	79	HT1S310	70	HT1S549	66	HT1S848	71	HT1W707	61
HT1S064	79	HT1S311	70	HT1S550	66	HT1S849	71	HT1W708	61
HT1S066	79	HT1S312	70	HT1S551	66	HT1S850	71	HT1W710	61
HT1S068	79	HT1S313	70	HT1S552	66	HT1S851	71	HT1W711	61
HT1S072	79	HT1S314	69	HT1S553	66	HT1S852	71	HT1W712	61
HT1S077	79	HT1S315	69	HT1S554	66	HT1S853	71	HT1W713	61
HT1S094	75	HT1S316	69	HT1S555	66	HT1S885	71	HT1W714	61
HT1S095	76	HT1S317	69	HT1S585	66	HT1S886	71	HT1W730	81
HT1S096	76	HT1S318	71	HT1S586	66	HT1S888	71	HT1W760	161
HT1S097	76	HT1S319	71	HT1S588	66	HT1S890	71	HT1W761	161
HT1S098	76	HT1S321	71	HT1S590	66	HT1S902	80	HT1W800	73
HT1S099	77	HT1S322	71	HT1S592	66	HT1S903	80	HT1W801	73
HT1S100	76	HT1S323	70	HT1S594	66	HT1S904	80	HT1W802	72
HT1S101	76	HT1S324	71	HT1S596	66	HT1S905	80	HT1W803	73
HT1S105	77	HT1S330	69	HT1S597	66	HT1S920	81	HT1W804	73
HT1S120	71	HT1S331	69	HT1S601	64	HT1S922	81	HT1W806	75
HT1S121	71	HT1S332	69	HT1S602	64	HT1S924	81	HT1W807	73
HT1S122	71	HT1S334	70	HT1S603	64	HT1S940	81	HT1W808	73
HT1S123	71	HT1S335	70	HT1S606	65	HT1S941	81	HT1W809	74
HT1S125	71	HT1S336	70	HT1S607	65	HT1S944	81	HT1W810	74
HT1S126	71	HT1S337	70	HT1S608	65	HT1S960	81	HT1W814	73
HT1S127	71	HT1S338	70	HT1S623	65	HT1S961	81	HT1W816	75
HT1S128	71	HT1S339	70	HT1S624	65	HT1S962	81	HT1W817	75
HT1S130	71	HT1S340	70	HT1S625	65	HT1S965	81	HT1W818	73
HT1S131	71	HT1S341	70	HT1S626	65	HT1S966	81	HT1W820	74
HT1S132	71	HT1S342	70	HT1S627	65	HT1S968	81	HT1W821	74
HT1S135	72	HT1S343	70	HT1S628	65	HT1S969	81	HT1W822	74
HT1S136	72	HT1S344	70	HT1S640	65	HT1S973	81	HT1W825	74
HT1S137	72	HT1S345	70	HT1S642	65	HT1S974	81	HT1W826	74
HT1S138	72	HT1S346	70	HT1S643	65	HT1S976	81	HT1W830	74
HT1S139	72	HT1S347	70	HT1S644	65	HT1S977	81	HT1W831	75
HT1S140	72	HT1S348	70	HT1S645	65	HT1S981	131	HT1W879	61
HT1S141	72	HT1S349	70	HT1S646	65	HT1S982	131		
HT1S142	72	HT1S350	70	HT1S647	65	HT1S986	80		
HT1S145	72	HT1S359	70	HT1S648	65	HT1S990	80		
HT1S146	72	HT1S361	70	HT1S649	65	HT1S994	80		
HT1S147	72	HT1S362	70	HT1S670	65	HT1S996	80		
HT1S148	72	HT1S363	70	HT1S671	65	HT1S997	80		
HT1S150	72	HT1S364	70	HT1S672	65	HT1S998	80		
								HT2	
								HT2C002	197
								HT2C004	197
								HT2C050	197

HT2C052	197
HT2C054	197
HT2C056	197
HT2C058	197
HT2C059	197
HT2C101	196
HT2C107	196
HT2C108	196
HT2C131	196
HT2C135	196
HT2C137	196
HT2C138	196
HT2C141	196
HT2C152	197
HT2C154	197
HT2C156	197
HT2C180	197
HT2C181	198
HT2C191	198
HT2C301	198
HT2C302	198
HT2C303	198
HT2C304	198
HT2C310	198
HT2C311	198
HT2C400	144
HT2C401	145
HT2C500	145
HT2C501	145
HT2C502	145
HT2C503	145
HT2C504	145
HT2C505	145
HT2C509	145
HT2C550	202
HT2C551	202
HT2C552	202
HT2E100	202
HT2E101	202
HT2E105	202
HT2E106	203
HT2E115	203
HT2E116	203
HT2E130	203
HT2E200	100
HT2E210	100

HT3

HT3B001	148
HT3B003	148
HT3B005	148
HT3B008	148
HT3B010	148
HT3B015	148
HT3B020	148
HT3B021	148
HT3B023	148
HT3B025	148
HT3B028	148
HT3B029	148
HT3B030	148
HT3B031	148
HT3B033	148
HT3B034	148
HT3B035	149
HT3B036	149
HT3B038	148
HT3B039	148
HT3B041	149
HT3B043	149
HT3B044	149
HT3B045	149
HT3B046	149
HT3B048	149

HT3B052	149
HT3B060	150
HT3B062	150
HT3B064	150
HT3B066	150
HT3B069	150
HT3B070	150
HT3B071	150
HT3B072	150
HT3B073	150
HT3B076	150
HT3B091	149
HT3B094	148
HT3B095	148
HT3B097	148
HT3B500	150
HT3B501	150
HT3B502	150
HT3B504	150
HT3B505	152
HT3B506	152
HT3B509	152
HT3B519	152
HT3B520	152
HT3B521	152
HT3B522	152
HT3B523	152
HT3B524	152
HT3B525	152
HT3B526	152
HT3B527	152
HT3B540	152
HT3B548	152
HT3B580	177
HT3B581	177
HT3B582	178
HT3B617	85
HT3B618	85
HT3B619	85
HT3B621	153
HT3B622	153
HT3B623	153
HT3B624	152
HT3B625	152
HT3B626	152
HT3B640	153
HT3B641	153
HT3B650	159
HT3B651	159
HT3B655	159
HT3B656	159
HT3B657	159
HT3B660	161
HT3B665	161
HT3B670	153
HT3B700	153
HT3B708	153
HT3B710	154
HT3B712	154
HT3B713	154
HT3B721	154
HT3B722	154
HT3B723	154
HT3B724	154
HT3B725	154
HT3B726	154
HT3B727	154
HT3B728	154
HT3B729	154
HT3B770	159
HT3B771	159
HT3B772	159
HT3B774	159
HT3B775	159
HT3B776	159
HT3B777	159

HT3B778	159
HT3B800	154
HT3B801	154
HT3B802	155
HT3B804	155
HT3B808	155
HT3B809	155
HT3B810	155
HT3B811	155
HT3B841	155
HT3B842	155
HT3B843	155
HT3B845	155
HT3B848	155
HT3B850	155
HT3B852	155
HT3B880	155
HT3B881	155
HT3B882	155
HT3B902	156
HT3B904	156
HT3B906	156
HT3B908	156
HT3B909	156
HT3B910	156
HT3B911	156
HT3B912	156
HT3B913	156
HT3B914	156
HT3B915	156
HT3B916	156
HT3B917	156
HT3B918	156
HT3B920	156
HT3B921	156
HT3B922	156
HT3B935	157
HT3B936	157
HT3B937	157
HT3B938	157
HT3B939	157
HT3B940	157
HT3B941	156
HT3B942	156
HT3B943	156
HT3B944	157
HT3B946	157
HT3B950	157
HT3B952	157
HT3B954	157
HT3B960	157
HT3B963	157
HT3S202	157
HT3S204	157
HT3S206	157
HT3S232	157
HT3S234	158
HT3S238	158
HT3S270	158
HT3S274-D	158
HT3S277	158
HT3S280	158
HT3S285	158
HT3S286	158
HT3S295	158

HT4

HT4C603-D	187
HT4C604	188
HT4C605	188
HT4C606	188
HT4C607	188
HT4C612	188
HT4C613	188

HT4C614	188
HT4C622	188
HT4C623	190
HT4C625	190
HT4C626	190
HT4C627	190
HT4C628	190
HT4C629	190
HT4C630	190
HT4C632	190
HT4C635	190
HT4C636	190
HT4C637	191
HT4C638	191
HT4C639	191
HT4C640	191
HT4C641	191
HT4C642	191
HT4C650	191
HT4C651	191
HT4C652	192
HT4C661	192
HT4C662	192
HT4C664	192
HT4C665	192
HT4C667	193
HT4C668	193
HT4C669	193
HT4C670	192
HT4C671	192
HT4C672	192
HT4C673	193
HT4C674	193
HT4M001-D	167
HT4M003	167
HT4M005	167
HT4M006	167
HT4M007	167
HT4M008	167
HT4M009	167
HT4M010	167
HT4M011	167
HT4M012	167
HT4M013	167
HT4M015	167
HT4M016	167
HT4M020	167
HT4M021	167
HT4M040	167
HT4M070	167
HT4M071	167
HT4M072	168
HT4M074	168
HT4M079	167
HT4M202	166
HT4M203	166
HT4M206	166
HT4M214	166
HT4M215	166
HT4M216	166
HT4M217	166
HT4M218	159
HT4M261-D	165
HT4M262	166
HT4M270	166
HT4M274	166
HT4M322	165
HT4M323	165
HT4M324	165
HT4M340	168
HT4M341	168
HT4M342	168
HT4M400	164
HT4M401	164
HT4M402	164
HT4M405	164

HT4M406	164
HT4M407	164
HT4M409	165
HT4M410	165
HT4M411	165
HT4M423	164
HT4M425	164
HT4M426	164
HT4M428	164
HT4M429	165
HT4M430	165
HT4M431	165
HT4M432	164
HT4M433	164
HT4M434	164
HT4M435	164
HT4M436	165
HT4M437	164
HT4M438	164
HT4M473	165
HT4M475	165
HT4M476	165
HT4M477	165
HT4M478	165
HT4M479	165
HT4R006	89
HT4R010	89
HT4R011	89
HT4R012	89
HT4R013	89
HT4R014	89
HT4R015	89
HT4R016	89
HT4R017	89
HT4R018	89
HT4R019	89
HT4R020	89
HT4R021	89
HT4R022	89
HT4R023	89
HT4R024	89
HT4R027	89
HT4R030	89
HT4R032	89
HT4R049	89
HT4R104	89
HT4R111	89
HT4R112	89
HT4R113	89
HT4R114	89
HT4R115	89
HT4R116	89
HT4R120	89
HT4R122	89
HT4R124	89
HT4R211	89
HT4R212	89
HT4R213	89
HT4R214	89
HT4R217	89
HT4R302	89
HT4R304	89
HT4R306	89
HT4R315	90
HT4R316	90
HT4R320	90
HT4R324	90
HT4R326	90
HT4R328	90
HT4R402	161
HT4R405	161
HT4R422	161
HT4R425	161
HT4R502	125
HT4R504	125
HT4R506	125

HT4R508	125
HT4R509	125
HT4R510	125
HT4R512	126
HT4R518	126
HT4R519	126
HT4R520	126
HT4R521	126
HT4R522	126
HT4R621	88
HT4R622	88
HT4R623	88
HT4R625	88
HT4R630	88
HT4R635	88
HT4R650	88
HT4R651	88
HT4R652	89
HT4R712	91
HT4R716	91
HT4R718	91
HT4R746	91
HT4R747	91
HT4R748	91
HT4R749	91
HT4R750	91
HT4R751	91
HT4R755	91
HT4R757	92
HT4R758	92
HT4R780	107
HT4R781	105
HT4R790	119
HT4R795	119
HT4R801	92
HT4R802	92
HT4R803	92
HT4R804	92
HT4R810	92
HT4R811	92
HT4R812	92
HT4R813	92
HT4R820	92
HT4R821	92
HT4R870	92
HT4R871	92
HT4R872	92
HT4R873	93
HT4R874	93
HT4R875	93
HT4R876	93
HT4R890	93
HT4R891	93
HT4R892	93
HT4R894	93
HT4R897	93
HT4R898	93
HT4R899	93

HT6

HT6D084	175
HT6D085	175
HT6D086	175
HT6D088	175
HT6D090	175
HT6D103	174
HT6D104	174
HT6D105	174
HT6D108	174
HT6D109	174
HT6D111	174
HT6D112	174
HT6D114	174
HT6D116	174

HT6D117	174
HT6D119	174
HT6D122	174
HT6D123	174
HT6D126	174
HT6D127	174
HT6D129	174
HT6D132	174
HT6D134	174
HT6D137	174
HT6D139	174
HT6D141	174
HT6D180	174
HT6D186	174
HT6D201	172
HT6D202	172
HT6D203	172
HT6D204	172
HT6D205	172
HT6D206	172
HT6D207	172
HT6D209	172
HT6D210	172
HT6D213	172
HT6D214	172
HT6D215	172
HT6D218	172
HT6D220	172
HT6D224	172
HT6D226	172
HT6D231	172
HT6D233	172
HT6D236	172
HT6D237	172
HT6D240	172
HT6D242	172
HT6D248	172
HT6D280	172
HT6D281	172
HT6D282	172
HT6D284	172
HT6D290	173
HT6D291	173
HT6D292	173
HT6D310	177
HT6D312	177
HT6D314	177
HT6D316	177
HT6D317	177
HT6D320	177
HT6D321	175
HT6D322	175
HT6D323	175
HT6D324	175
HT6D325	175
HT6D326	175
HT6D330	174
HT6D336	175
HT6D344	177
HT6D345	177
HT6D346	177
HT6D348	177
HT6D370	172
HT6D378	174
HT6D380	173
HT6D381	173
HT6D382	173
HT6D383	173
HT6D384	173
HT6D385	173
HT6D388	173
HT6D389	173
HT6D392	173
HT6D404	178
HT6D406	178

HT6D408	178
HT6D410	178
HT6D412	178
HT6D414	178
HT6D416	178
HT6D417	178
HT6D420	178
HT6D424	178
HT6D426	178
HT6D429	178
HT6D431	178
HT6D433	178
HT6D435	178
HT6D436	178
HT6D437	178
HT6D438	178
HT6D439	178
HT6D440	178
HT6D441	178
HT6D442	178
HT6D445	178
HT6D447	178
HT6D448	178
HT6D450	178
HT6D452	178
HT6D453	178
HT6D455	178
HT6D462	178
HT6D463	178
HT6D466	178
HT6D470	173
HT6D476	173
HT6D478	173
HT6D484	173
HT6D486	173
HT6D487	173
HT6D489	173
HT6D490	173
HT6D492	173
HT6D504	177
HT6D505	177
HT6D523	175
HT6D524	175
HT6D525	175
HT6D526	175
HT6D527	175
HT6D528	175
HT6D530	175
HT6D541	177
HT6D543	177
HT6D544	177
HT6D545	177
HT6D546	177
HT6D547	177
HT6D548	177
HT6D549	177
HT6D550	177
HT6D551	177
HT6D552	177
HT6D553	177
HT6D554	177
HT6D555	177
HT6D556	177
HT6D557	177
HT6D558	177
HT6D601	179
HT6D602	179
HT6D604	179
HT6D606	179
HT6D616	179
HT6D630	179
HT6D631	179
HT6D632	179
HT6D633	179
HT6D634	179

HT6D635	179
HT6D636	179
HT6D638	179
HT6D640	180
HT6D650	182
HT6D650-2	180
HT6D651	180
HT6D653	180
HT6D654-2	180
HT6D656-2	180
HT6D657	180
HT6D659	180
HT6D660	182
HT6D660-2	182
HT6D661-2	182
HT6D663-2	182
HT6D665	182
HT6D666	182
HT6D667	182
HT6D668	182
HT6D668	182
HT6D670	182
HT6D671	183
HT6D672	183
HT6D673	183
HT6D674	182
HT6D680-2	183
HT6D682-2	183
HT6D690	182
HT6D701	178
HT6D702	178
HT6D703	178
HT6D706	178
HT6D711	178
HT6D712	178
HT6D716	178
HT6D721	179
HT6D722	179
HT6D742	179
HT6D746	179
HT6D748	179
HT6D802	174
HT6D807	174
HT6D812	174
HT6D817	174
HT6D822	174
HT6D824	174
HT6D825	174
HT6D827	174
HT6D832	174
HT6D834	174
HT6D837	174
HT6D840	174
HT6D842	174
HT6D844	174
HT6D847	174
HT6D852	174
HT6D854	174
HT6D857	174
HT6D862	174
HT6D867	174
HT6D872	174
HT6D874	174
HT6D877	174
HT6D882	174
HT6D887	174
HT6D892	174
HT6D893	174
HT6D894	174
HT6D895	174
HT6D896	174
HT6D897	174
HT6D898	174
HT6D899	174
HT6D901	183

HT6D902	183
HT6D904	183
HT6D916	184
HT6D923	184
HT6D992	179
HT6R002	90
HT6R004	90
HT6R006	90

HT7

HT7D110	175
HT7D112	175
HT7D114	175
HT7D116	175
HT7D118	175
HT7D120	175
HT7D122	175
HT7D124	175
HT7D125	175
HT7D128	175
HT7D130	175
HT7D132	175
HT7D135	175
HT7D138	175
HT7D140	175
HT7D158	177
HT7D270	178
HT7D272	178
HT7D274	178
HT7D276	178
HT7D278	178
HT7D280	178
HT7D282	178
HT7D284	178
HT7D285	178
HT7D286	178
HT7D290	178
HT7D294	178
HT7D296	178
HT7D306	178
HT7D308	178
HT7D310	178
HT7D312	178
HT7D314	178
HT7D318	178
HT7D322	178
HT7D325	178
HT7D332	178
HT7D335	178
HT7D338	178
HT7D340	178
HT7D344	178
HT7D350	178
HT7D353	178
HT7D360	178
HT7D365	178
HT7D367	178
HT7D373	178
HT7D383	178
HT7D702	185
HT7D704	185
HT7D706	185
HT7D712	185
HT7D713	187
HT7D716	187
HT7D722	187
HT7D724	187
HT7D732	187
HT7D734	187
HT7D738	187
HT7D915	172
HT7D916	172
HT7D917	172
HT7D918	172

HT7D923 172
 HT7D924 172
 HT7D925 172
 HT7D929 172
 HT7D930 172
 HT7D931 172
 HT7D933 172
 HT7D934 172
 HT7D937 172
 HT7D938 172
 HT7D941 172
 HT7D942 172
 HT7D945 172
 HT7D950 172
 HT7D955 172
 HT7D956 172
 HT7D960 172
 HT7D961 172
 HT7D964 172
 HT7D965 172
 HT7D973 172
 HT7G010 209
 HT7G011 209
 HT7G012 209
 HT7G018 209
 HT7G022 211
 HT7G024 211
 HT7G026 211
 HT7G033 210
 HT7G034 211
 HT7G045 206
 HT7G046 206
 HT7G047 206
 HT7G048 206
 HT7G049 206
 HT7G052 206
 HT7G054 207
 HT7G055 207
 HT7G056 207
 HT7G058 207
 HT7G059 207
 HT7G060 209
 HT7G061 210
 HT7G063 210
 HT7G064 210
 HT7G065 210
 HT7G066 210
 HT7G072 208
 HT7G074 208
 HT7G075 208
 HT7G077 208
 HT7G078 209
 HT7G080 208
 HT7G081 208
 HT7G120 211
 HT7G121 211
 HT7G122 212
 HT7G123 212
 HT7G124 212
 HT7G125 212
 HT7G126 212
 HT7G127 212
 HT7G128 213
 HT7G129 213
 HT7G130 213
 HT7G131 213
 HT7G132 213
 HT7G133 213
 HT7G134 214
 HT7G135 214
 HT7G136 214
 HT7G137 214
 HT7G139 214
 HT7G141 214
 HT7G142 215
 HT7G144 215

HT7G145 215
 HT7G146 215
 HT7G147 215
 HT7G148 216
 HT7G149 215
 HT7G150 216
 HT7G151 216
 HT7G160 207

HT8

HT8D001 184
 HT8D002 184
 HT8D003 184
 HT8D004 184
 HT8D005 184
 HT8D006 184
 HT8D010 184
 HT8D011 184
 HT8D012 184
 HT8D013 184
 HT8D014 184
 HT8D015 184
 HT8D020 184
 HT8D021 184
 HT8D022 184
 HT8D023 184
 HT8D024 184
 HT8D025 184
 HT8D051 184
 HT8D052 184
 HT8D053 184
 HT8D054 184
 HT8D055 184
 HT8D100 184
 HT8D101 184
 HT8D102 184
 HT8D103 184
 HT8D104 184
 HT8D105 184
 HT8D106 184
 HT8D107 184
 HT8D108 184
 HT8D120 184
 HT8D121 184
 HT8D122 184
 HT8D123 184
 HT8D124 184
 HT8D125 184
 HT8D126 184
 HT8D127 184
 HT8D130 184
 HT8D131 184
 HT8D132 184
 HT8D133 184
 HT8D134 184
 HT8D135 184
 HT8D136 184
 HT8D137 184
 HT8D138 184
 HT8D140 184
 HT8D141 184
 HT8D142 184
 HT8D143 184
 HT8D144 184
 HT8D145 184
 HT8D146 184
 HT8D147 184
 HT8D148 184
 HT8D149 184
 HT8D150 184
 HT8D190 185
 HT8D195 185
 HT8D200 185

HT8D210 185
 HT8G004 96
 HT8G006 96
 HT8G022 96
 HT8G024 96
 HT8G052 96
 HT8G053 96
 HT8G056 96
 HT8G100 96
 HT8G200 96
 HT8G201 96
 HT8G202 96
 HT8G203 96
 HT8G205 96
 HT8G206 96
 HT8G207 96
 HT8G208 96
 HT8G210 96
 HT8G211 96
 HT8G212 96
 HT8G213 96
 HT8G215 97
 HT8G216 97
 HT8G217 97
 HT8G218 97
 HT8G225 97
 HT8G226 97
 HT8G227 97
 HT8G228 97
 HT8G229 97
 HT8G230 97
 HT8G231 97
 HT8G232 97
 HT8G240 97
 HT8G241 97
 HT8G242 97
 HT8G245 99
 HT8G246 99
 HT8G247 99
 HT8G248 99
 HT8G250 99
 HT8G251 99
 HT8G252 99
 HT8G253 99
 HT8G254 100
 HT8G255 100
 HT8G256 100
 HT8G257 100
 HT8G258 100
 HT8G301 100
 HT8G302 100
 HT8G303 100
 HT8G304 100
 HT8G305 102
 HT8G306 100
 HT8G307 102
 HT8G310 102
 HT8G311 102
 HT8G314 102
 HT8G315 102
 HT8G316 102
 HT8G317 102
 HT8G318 103
 HT8G319 103
 HT8G320 103
 HT8G321 103
 HT8G322 103
 HT8G323 103
 HT8G324 103
 HT8G325 103
 HT8G326 103
 HT8G327 104
 HT8G328 104
 HT8G329 104

HT8G330 104
 HT8G331 104
 HT8G340 104
 HT8G341 104
 HT8G342 104
 HT8G343 104
 HT8G344 105
 HT8G345 105
 HT8G346 105
 HT8G347 105
 HT8G348 105
 HT8G349 105
 HT8G360 105
 HT8G361 106
 HT8G362 106
 HT8G363 106
 HT8G364 106
 HT8G370 106
 HT8G371 106
 HT8G372 106
 HT8G373 106
 HT8G374 107
 HT8G375 107
 HT8G376 107
 HT8G390 107
 HT8G391 107
 HT8G392 107
 HT8G393 107
 HT8G394 108
 HT8G400 108
 HT8G401 108
 HT8G402 108
 HT8G403 108
 HT8G404 108
 HT8G405 108
 HT8G406 108
 HT8G410 109
 HT8G411 109
 HT8G412 109
 HT8G413 109
 HT8G414 109
 HT8G415 109
 HT8G416 109
 HT8G418 109
 HT8G419 111
 HT8G420 111
 HT8G421 111
 HT8G422 111
 HT8G423 111
 HT8G424 111
 HT8G425 111
 HT8G426 111
 HT8G427 111
 HT8G428 111
 HT8G429 112
 HT8G430 112
 HT8G431 112
 HT8G432 112
 HT8G433 112
 HT8G434 112
 HT8G435 112
 HT8G436 112
 HT8G437 113
 HT8G460 113
 HT8G500 113
 HT8G501 113
 HT8G502 113
 HT8G503 113
 HT8G504 113
 HT8G505 113
 HT8G506 114
 HT8G507 114
 HT8G508 114
 HT8G509 114

HT8G510 114
 HT8G511 114
 HT8G512 114
 HT8G513 114
 HT8G514 115
 HT8G515 115
 HT8G516 115
 HT8G517 115
 HT8G550 115
 HT8G551 115
 HT8G552 115
 HT8G553 115
 HT8G554 116
 HT8G555 116
 HT8G556 116
 HT8G557 116
 HT8G558 116
 HT8G559 116
 HT8G560 116
 HT8G561 116
 HT8G601 117
 HT8G602 117
 HT8G610 117
 HT8G611 117
 HT8G613 117
 HT8G614 117
 HT8G616 117
 HT8G620 117
 HT8G904 117
 HT8G905 119
 HT8G907 119
 HT8G908 119
 HT8G912 119
 HT8G913 119
 HT8G915 119
 HT8G920 120
 HT8G925 120
 HT8G930 120
 HT8G935 120
 HT8G936 120
 HT8G937 120
 HT8G940 120
 HT8G945 120
 HT8G946 121
 HT8G947 121

HÖGERT
technik

DE Mechanische Werkzeuge

EN Mechanical Tools

FR Outils Mécaniques

ES Herramientas Mecánicas

HR Mehanički Alati

HU Mechanikus Szerszámok

RO Unelte Mecanice

BG Механични Инструменти





HT1R328 CrMo

HT1R324 CrMo

CrMo

HÖGERT

HÖGERT

HÖGERT

HÖGERT

DE Doppelring Ratschen Steckschlüssel mit Ersatzteilen EN Double ratchet wrench with sockets FR Clé à cliquet double réversibles avec jeux de douilles ES Llave de tubo de trinquete de doble cabezal HR Okasti ključ s čegrtaljkom s nastavcima HU Racsnis kulcskészlet RO Set chei cu clichet BG Ключ звездогаечен с тресчотка



8, 9, 10, 11, 12, 13, 15, 16, 17, 18 mm
14, 19 mm



x11 72T CrV

HT1R490	14 x 19 mm	5	20

DE Werkzeugsatz EN Tool set FR Kit d'outils ES Set de herramientas HR Garnitura alata HU Szerszámkészlet RO Trusa de scule BG Комплект инструменти

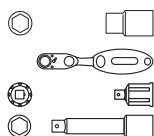

1/4":
10, 11, 12, 13, 14, 15, 16, 17, 18, 19, 21, 22, 24 mm
19 mm
1/4", 3/8"
80, 150 mm



x18 19 mm SPLINE GO-THROUGH 60T CrV CrMo ERGO TRAY

mm	10	11	12	13	14	15	16	18	19	21	22	24
inch	3/8	7/16	15/32	1/2		19/32	5/8		3/4	13/16	7/8	15/16
star	E12	E14	E16		E18		E20	E22	E24			

HT1R478	19 mm	1	8

DE Doppelring Ratschen Steckschlüssel mit Ersatzteilen EN Double ratchet wrench with sockets FR Clé à cliquet double réversibles avec jeux de douilles ES Llave de tubo de trinquete de doble cabezal HR Okasti ključ s čegrtaljkom s nastavcima HU Racsnis kulcskészlet RO Set chei cu clichet BG Ключ звездогаечен с тресчотка и вложки

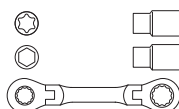

8, 9, 10, 11, 12, 13, 15, 16, 17, 18 mm
E8, E10, E11, E12, E14, E16, E18, E20, E22 mm
14, 19 mm



x20 72T CrV

HT1R492	14 x 19 mm	5	20

DE Werkzeugsatz EN Tool set FR Kit d'outils ES Set de herramientas HR Garnitura alata HU Szerszámkészlet RO Trusa de scule BG Комплект инструменти



- 1/2":**
- 8, 9, 10, 11, 12, 13, 14, 15, 16, 17, 18, 19, 20, 22, 24, 27, 30, 32, 36 mm
 - 15, 17, 19 mm
 - 16, 21 mm
 - 125, 250 mm
 - 1/2"
 - Adapter M1/2" – F3/8"
 - 1/2"



x29	1/2"	AS SYSTEM	6 PT	72T	CrMo	ERGOTRAY
-----	------	-----------	------	-----	------	----------

HT1R480	1/2"	1	4

DE Werkzeugsatz EN Tool set FR Kit d'outils ES Set de herramientas HR Garnitura alata HU Szerszámkészlet RO Trusa de scule BG Комплект инструменти



- 1/4":**
- 4, 4,5, 5, 5,5, 6, 7, 8, 9, 10, 11, 12, 13 mm
 - SL4, SL5,5, SL7 mm
 - PH1, PH2, PH3, PZ1, PZ2, PZ3
 - T15, T20, T25
 - H3, H4, H5, H6, H7, H8 mm;
 - 1/4", 150 mm
 - 1/4"
 - 1/4", 75 mm
 - 1/4"



x34	1/4"	AS SYSTEM	6 PT	72T	CrV	S2	ERGOTRAY
-----	------	-----------	------	-----	-----	----	----------

HT1R464	1/4"	1	8

DE Doppel Ratschenringschlüssel mit Gelenk mit Ersatzteilen EN Flexible double ratchet wrench with sockets FR Clés à douille et cliquets double réversibles avec jeux de douilles ES Llave combinada de trinquete flexible HR Okasti ključ s čegrtaljkom i zglobom s nastavcima HU Csuklós fejű kombinált racsnis kulcs RO Cheie combinata cu clichet, articulata BG Ключ звездагаечен с тресчотка с подвижна глава и вложки



- SL3, SL5, SL7 mm
 - PH1, PH2, PH3
 - PZ1, PZ2, PZ3
 - H2, H3, H4, H5, H6 mm
 - T15, T20, T25, T30, T40
 - 2, 3
 - 4, 6, 8
- 8, 9, 10, 11, 12, 13, 15, 16, 17, 18 mm
- 14, 19 mm



x36	FLEXIBLE HEAD	72T	CrV
-----	---------------	-----	-----

HT1R491	14 x 19 mm	5	20

DE Werkzeugsatz EN Tool set FR Kit d'outils ES Set de herramientas HR Garnitura alata HU Szerszámkészlet RO Trusa de scule BG Комплект инструменти



- 3/8":**
- 6, 7, 8, 9, 10, 11, 12, 13, 14, 15, 16, 17, 18, 19, 20, 21, 22, 24 mm
 - 8, 9, 10, 11, 12, 13, 14, 15, 16, 17, 18, 19 mm
 - 3/8"
 - 43, 100, 200 mm
 - 3/8"
 - Sliding adapter



x36 3/8" AS SYSTEM 6 PT 72 T CrV S2 CrMo ERGO TRAY

HT1R465	3/8"	1	4

DE Werkzeugsatz EN Tool set FR Kit d'outils ES Set de herramientas HR Garnitura alata HU Szerszámkészlet RO Trusa de scule BG Комплект инструменти



- Bits 10 mm - length 30 mm:**
- PH2, PH3
 - T20, T25, T30, T40, T45, T50, T55, T60
 - M5, M6, M8, M10, M12
 - H4, H5, H6, H8, H10, H12 mm
- length 75 mm:**
- T25, T27, T30, T40, T45, T50, T55
 - H5, H6, H7, H8, H10 mm
- length 120 mm:**
- T45, T50, T55
 - 10 mm bits



x37 72 T CrMo S2 PH SPLINE TORX HEX

HT1R466	10 mm	1	8

DE Werkzeugsatz EN Tool set FR Kit d'outils ES Set de herramientas HR Garnitura alata HU Szerszámkészlet RO Trusa de scule BG Комплект инструменти



- 1/4":**
- 5, 5, 6, 7, 8, 9, 10, 11, 12, 13, 14 mm
 - SL3, SL4, SL5, SL6 mm
 - PH1, PH2 x 2, PH3
 - PZ1, PZ2, PZ3
 - TT10, TT15, TT20, TT25, TT27, TT30, TT40
 - H3, H4, H5, H6 mm
 - 1/4"
 - 1/4"
 - 50, 100 mm
 - 1/4"
 - 1/4"



x38 1/4" AS SYSTEM 72 T CrMo S2 CrV ERGO TRAY

HT1R462	1/4"	5	20

DE Schraubenzieherspitzen im Set EN Screwdriver bits set FR Coffret d'embouts ES Set de puntas de atornillar, caja de metal HR Garnitura bitova odvijača HU Szerszámkészlet RO Trusa de scule BG Комплект битове



3/8":

- 30 mm: T20, T25, T30, T40, T45, T50, T55
- 75 mm: T20, T25, T30, T40, T45, T50, T55
- 30 mm: M5, M6, M8, M10, M12
- 75 mm: M5, M6, M8, M10, M12
- 30 mm: H4, H5, H6, H7, H8, H10, H12
- 75 mm: H4, H5, H6, H7, H8, H10, H12
- 10 mm, 3/8"
- 10 mm, 1/2"



x40	S2	3/8" 1/2"	TORX	SPLINE	HEX
-----	----	--------------	------	--------	-----

HT1S405	3/8", 1/2"	1	10

DE Schraubenzieherspitzen im Set EN Screwdriver bits set FR Coffret d'embouts ES Set de puntas de atornillar, caja de metal HR Garnitura bitova odvijača HU Szerszámkészlet RO Trusa de scule BG Комплект битове



3/8":

- 30 mm: T20, T25, T30, T40, T45, T50, T55
- 75 mm: T20, T25, T30, T40, T45, T50, T55
- 30 mm: M5, M6, M8, M10, M12
- 75 mm: M5, M6, M8, M10, M12
- 30 mm: H4, H5, H6, H7, H8, H10, H12
- 75 mm: H4, H5, H6, H7, H8, H10, H12
- 10 mm, 3/8"
- 10 mm, 1/2"



x40	CrV	3/8" 1/2"	TORX	SPLINE	HEX
-----	-----	--------------	------	--------	-----

HT1S404	3/8", 1/2"	1	10

DE Werkzeugsatz EN Tool set FR Kit d'outils ES Set de herramientas HR Garnitura alata HU Szerszámkészlet RO Trusa de scule BG Комплект инструменти



1/4":

- SL4, SL5,5, SL7
- PH1, PH2, PH3
- PZ1, PZ2, PZ3
- T10, T15, T20, T25, T27, T30, T40
- H3, H4, H5, H6, H7, H8
- 4, 4.5, 5, 5.5, 6, 7, 8, 9, 10, 11, 12, 13, 14 mm
- 72T
- 50/100 mm
- 150 mm
- 30 mm
- 1/4"
- 1/4"
- 1/4"
- 1.27, 1.5, 2, 2.5 mm



x47	1/4"	AS SYSTEM	72 T	CrMo	CrV
-----	------	-----------	------	------	-----

HT1R416	1/4"	1	10

DE Werkzeugsatz EN Tool set FR Kit d'outils ES Set de herramientas HR Garnitura alata HU Szerszámkészlet RO Trusa de scule BG Комплект инструменти



- 1/4":**
- 4, 4.5, 5, 5.5, 6, 7, 8, 9, 10, 11, 12, 13 mm
 - 1/4"
 - 72T
 - 150 mm
 - 100 mm
 - 1/4"
 - 1.5, 2.0, 2.5 mm
 - PH1, 2 x PH2, PH3
 - PZ1, PZ2, PZ3
 - SL3, SL4, SL5, SL5.5 mm
 - H3, H4, H5, H6, H8
 - TT8, TT10, TT15, TT20, TT25, TT27, TT30, TT40
 - M5, M6, M8
 - 1, 2, 3
 - 6, 8, 10



x53 1/4" AS SYSTEM 72 T CrV CrMo ERGO TRAY

HT1R485	1/4"	1	10

DE Werkzeugsatz EN Tool set FR Kit d'outils ES Set de herramientas HR Garnitura alata HU Szerszámkészlet RO Trusa de scule BG Комплект инструменти



- 1/4":**
- 5, 5.5, 6, 7, 8, 9, 10, 11, 12, 13 mm
 - 1/4"
 - 75 mm
 - 1/4"
 - 150 mm
 - 110 mm
 - 1/4"
 - 1/4"
 - PH1, PH2, PH3
 - SL4.5 SL6.5
 - SL8
- 1/2":**
- H3, H4, H5, H6
 - T10, T15, T20, T25, T27, T30, T40
 - 8, 9, 10, 11, 12, 13, 14, 15, 16, 17, 18, 19, 21, 22, 24, 27, 30, 32 mm
 - 16, 21 mm
 - 1/2"
 - 125, 250 mm
 - 1/2", 250 mm
 - 1/2"



x60 SPLINE 1/4" @ 1/2" 72 T CrV S2 ERGO TRAY

mm	5.5	6	8	10	11	12	13	14	15	16	18	19	21	22	24	27	30	32
inch	7/32	5/16	3/8	7/16	15/32	1/2	19/32	5/8	3/4	13/16	7/8	15/16	1,1/16	1,1/8	1,1/4			
star	E8	E10	E12	E14	E16	E18	E20	E22	E24									

HT1R470	1/4", 1/2"	1	3

DE Werkzeugsatz EN Tool set FR Kit d'outils ES Set de herramientas HR Garnitura alata HU Szerszámkészlet RO Trusa de scule BG Комплект инструменти



- 1/4":**
- 4, 4.5, 5, 5.5, 6, 7, 8, 9, 10, 11, 12, 13, 14 mm
 - 4, 4.5, 5, 5.5, 6, 7, 8, 9, 10, 11, 12, 13, 14 mm
 - E4, E5, E6, E7, E8, E10
 - 50, 100, 150 mm
 - 140 mm
 - 110 mm
 - 1/4"
 - 150 mm
 - 1/4"
 - 1/4"
 - 1/4"
 - SL4, SL5.5, SL7
 - PZ1, PZ2, PZ3
 - PH1, PH2, PH3
 - T8, T10, T15, T20, T25, T30, T40
 - H3, H4, H5, H6, H7, H8



x63 1/4" AS SYSTEM 72 T CrMo CrV

HT1R486	1/4"	1	4

DE Werkzeugsatz EN Tool set FR Kit d'outils ES Set de herramientas HR Garnitura alata HU Szerszámkészlet RO Trusa de scule BG Комплект инструменти

DE Werkzeugsatz EN Tool set FR Kit d'outils ES Set de herramientas HR Garnitura alata HU Szerszámkészlet RO Trusa de scule BG Комплект инструменти



- 1/4":**
- 4, 4.5, 5, 5.5, 6, 7, 8, 9, 10, 11, 12, 13, 14 mm
 - 50, 100 mm
 - 150 mm
 - Universal Joint
 - 152 mm
 - 1/4" bits
 - 72T
 - 150 mm
 - SL 4, SL 5.5, SL 7
 - PH1, PH2
 - PZ1, PZ2
 - T8, T10, T15, T20, T25, T30
 - H3, H4, H5, H6
- 5/16":**
- SL 8, SL 10, SL 12
 - PH3, PH4
 - PZ3, PZ4
 - T40, T45, T50, T55
 - H8, H10, H12, H14
- 1/2":**
- 14, 15, 16, 17, 18, 19, 20, 22, 24, 27, 30, 32 mm
 - 125, 250 mm
 - M1/2-F3/8
 - Universal Joint
 - 16, 21 mm
 - 5/16"
 - 72T
 - 8, 10, 11, 12, 13, 14, 17, 19, 22 mm
 - 1.5, 2.0, 2.5 mm

- 1/2":**
- 10, 11, 12, 13, 14, 15, 16, 17, 18, 19, 20, 21, 22, 24, 27, 30, 32, 36 mm
 - 254 mm with 3 way adaptor
 - 72T
- 1/4":**
- 4, 4.5, 5, 5.5, 6, 7, 8, 9, 10, 11, 12, 13, 14 mm
 - 150 mm
 - 115 mm
 - 50, 100 mm
 - 72T
 - 1.27, 1.5, 2.0, 2.5, 3.0 mm
 - SL4, SL5, SL5.5, SL6, SL8 mm
 - PH1, PH2
 - PZ1, PZ2
 - T8, T10, T15, T20x2, T25x2, T27, T30
 - TT8, TT10, TT15, TT20, TT25, TT27, TT30
 - H3, H4, H5, H6
 - TH3, TH4, TH5, TH6
 - 1, 2, 3
 - 6, 8, 10
 - M5, M6, M8
 - 1, 2
 - 1/4"



x85	1/4" 1/2"	AS SYSTEM
72T	CrMo	CrV

HT1R425	1/4", 1/2"	1	4

x89	1/4" 1/2"	AS SYSTEM
72T	CrMo	CrV

HT1R424	1/4", 1/2"	1	4

DE Werkzeugsatz EN Tool set FR Kit d'outils ES Set de herramientas HR Garnitura alata HU Szerszámkészlet RO Trusa de scule BG Комплект инструменти

DE Werkzeugsatz EN Tool set FR Kit d'outils ES Set de herramientas HR Garnitura alata HU Szerszámkészlet RO Trusa de scule BG Комплект инструменти



1/4":

- 4, 4.5, 5, 5.5, 6, 7, 8, 9, 10, 11, 12, 13, 14 mm
- 6, 7, 8, 9, 10, 11, 12, 13 mm
- 3, 4, 5, 6 mm
- T8, T10, T15, T20, T25, T30
- 4, 5.5, 7mm
- PH1, PH2
- PZ1, PZ2
- 1/4"
- 50, 100 mm
- 150 mm
- 115 mm
- Spinner handle
- Universal Joint
- 72T

1/2":

- 10, 11, 12, 13, 14, 15, 16, 17, 18, 19, 20, 21, 22, 23, 24, 27, 30, 32 mm
- 14, 15, 17, 19 mm
- Universal Joint
- 3 way adapter
- 127, 254 mm
- 1/2"
- 72T
- 16, 21 mm

5/16":

- 8, 10, 12, 14 mm
- T40, T45, T50, T55
- 8, 10, 12 mm
- PH3, PH4
- PZ3, PZ4
- 1.5, 2, 2.5 mm



x94	1/4" 1/2"	72T	CrMo	CrV
-----	--------------	-----	------	-----

HT1R450	1/2", 5/16", 1/4"	1	4
---------	-------------------	---	---

1/2":

- 10, 11, 12, 13, 14, 15, 16, 17, 18, 19, 20, 21, 22, 24, 27, 30, 32 mm
- 14, 15, 17, 19 mm
- 72T
- 125, 250 mm
- 16, 21 mm
- 3 Way Adapter
- 5/16"
- Universal Joint

5/16":

- 8, 10, 12
- PH3, PH4
- PPZ3, PZ4
- T40, T45, T50, T55
- H8, H10, H12, H14

1/4":

- 4, 5.5, 7 mm
- PH1, PH2
- PZ1, PZ2
- T8, T10, T15, T20, T25, T30
- H3, H4, H5, H6
- 4, 4.5, 5, 5.5, 6, 7, 8, 9, 10, 11, 12, 13, 14 mm
- 6, 7, 8, 9, 10, 11, 12, 13 mm
- 72T
- 50, 100 mm
- 150 mm
- 30 mm
- 150 mm
- 115 mm
- Universal joint
- 1.5, 2, 2.5, 3 mm



x95	1/2" 5/16" 1/4"	AS SYSTEM
72T	CrMo	CrV

HT1R426	1/2", 5/16", 1/4"	1	4
---------	-------------------	---	---

DE Werkzeugsatz EN Tool set FR Kit d'outils ES Set de herramientas HR Garnitura alata HU Szerszámkészlet RO Trusa de scule BG Комплект инструменти

DE Werkzeugsatz EN Tool set FR Kit d'outils ES Set de herramientas HR Garnitura alata HU Szerszámkészlet RO Trusa de scule BG Комплект инструменти



1/4":

- 4, 4.5, 5, 5.5, 6, 7, 8, 9, 10, 11, 12, 13, 14 mm
- 6, 7, 8, 9, 10, 11, 12, 13 mm
- E4, E5, E6, E7, E8
- 3, 4, 5, 6 mm
- T8, T10, T15, T20, T25, T27, T30
- 4, 5.5, 6.5 mm
- PH1, PH2
- PZ1, PZ2
- 1/4"
- 50, 100 mm
- 115 mm
- Spinner handle
- Universal Joint
- 72T

1/2":

- 10, 11, 12, 13, 14, 15, 16, 17, 18, 19, 20, 21, 22, 24, 27, 30, 32 mm
- 14, 15, 17, 19, 22 mm
- E10, E11, E12, E14, E16, E18, E20, E24
- Universal Joint
- 3 way adaptor
- 127, 254 mm
- 1/2"
- 72T
- 16, 21 mm

5/16":

- 7, 8, 10, 12, 14 mm
- T40, T45, T50, T55, T60
- 8, 10, 12 mm
- PH3, PH4
- PZ3, PZ4
- 1.5, 2, 2.5 mm



x108	1/4" 1/2"	AS SYSTEM

HT1R454	1/2", 5/16", 1/4"	1	3

1/2":

- 8, 10, 12
- PH3, PH4
- PZ3, PZ4
- T40, T45, T50, T55, T60
- H7, H8, H10, H12, H14
- 10, 11, 12, 13, 14, 15, 16, 17, 18, 19, 20, 21, 22, 23, 24, 27, 30, 32 mm
- 14, 15, 17, 19, 22 mm
- E10, E11, E12, E14, E16, E18, E20, E24
- 72T
- 125, 250 mm
- 16, 21 mm
- 3 Way Adaptor
- 5/16"
- Universal Joint

1/4":

- 4, 5.5, 7
- PH1, PH2
- PZ1, PZ2
- TT8, T10, T15, T20, T25, T27, T30
- H3, H4, H5, H6
- 4, 4.5, 5, 5.5, 6, 7, 8, 9, 10, 11, 12, 13, 14 mm
- 6, 7, 8, 9, 10, 11, 12, 13 mm
- E10, E11, E12, E14, E16, E18, E20, E24
- 72T
- 50, 100 mm
- 150 mm
- H30 mm
- 150 mm
- 115 mm
- Universal joint
- 1.27, 1.5, 2, 2.5 mm



x112	1/4" 1/2"	AS SYSTEM

HT1R432	1/4", 1/2"	1	4



DE Werkzeugsatz EN Tool set FR Kit d'outils ES Set de herramientas HR Garnitura alata HU Szerszámkészlet RO Trusa de scule BG Комплект инструменти



- 1/4":**
- 4, 4.5, 5, 5.5, 6, 7, 8, 9, 10, 11, 12, 13, 14 mm
 - 6, 7, 8, 9, 10, 11, 12, 13 mm
 - E4, E5, E6, E7, E8
 - 1/4" x 1/4"
 - 1/4" 75 mm
 - 150 mm
 - 1/4", 115 mm
 - 1/4"
 - 150 mm
 - Universal Joint: SL3; SL4, SL4.5; SL5; SL5.5; SL6; SL7
 - PH0, PH1, PH2, PH3, PH4
 - PZ0, PZ1, PZ2, PZ3, PZ4
 - H1.5; H2; H2.5; H3, H4, H5, H6
 - T10; T15, T20; T25; T27; T30
 - 72T

- 3/8":**
- 13, 14, 15, 16, 17, 18, 19 mm
 - 13, 14, 15 mm
 - E10, E11, E12, E14, E16, E18
 - 3/8 F x 1/4 M
 - 150 mm
 - Universal Joint
 - 72T
- 1/2":**
- 20, 21, 22, 24, 27, 30, 32 mm
 - 15, 17, 19 mm
 - E20, E22, E24
 - 16, 21 mm
 - 127, 254 mm
 - Adapter (3 in 1): 1/2"
 - Universal Joint
 - 72T

- 180 mm
- 160 mm
- 300 g
- Combination spanner: 8, 9, 10, 11, 12, 13, 14, 15, 16, 17, 18, 19 mm
- HEX keys: 1.5, 2, 2.5, 3, 4, 5, 6, 8, 10 mm
- Adjustable wrench: 250 mm
- Voltage tester: 110-250V
- Screwdrivers 2 pcs.: PH2 x 100 mm, SL6 x 100 mm
- Cutter: 175 mm
- Utility knife: 18 mm
- Magnetic holder

x131 1/4" 3/8" 1/2" AS SYSTEM 72T CrMo CrV

HT1R439	10 mm	1	8

DE Werkzeugsatz EN Tool set FR Kit d'outils ES Set de herramientas HR Garnitura alata HU Szerszámkészlet RO Trusa de scule BG Комплект инструменти



- 1/2":**
- 10, 11, 12, 13, 14, 15, 16, 17, 18, 19, 20, 21, 22, 24, 27, 30, 32, 36 mm
 - 14, 15, 17, 19 mm
 - 16/21 mm
 - Universal Joint
 - 245 mm with 3 way adaptor
 - 125 mm
 - 72T
- 5/16":**
- 1/2" x 5/16"
 - SL8, SL10, SL12
 - PH3, PH4
 - PZ3, PZ4
 - T40, T45, T50, T55
 - H8, H10, H12, H14

- 1/4":**
- 4, 4.5, 5, 5.5, 6, 7, 8, 9, 10, 11, 12, 13, 14 mm
 - 6, 7, 8, 9, 10, 11, 12, 13 mm
 - SL4, SL5.5, SL7
 - PH1, PH2
 - PZ1, PZ2
 - T8, T10, T15, T20, T25, T30
 - H3, H4, H5, H6
 - Spinner handle
 - 115 mm
 - 50, 100 mm
 - Universal Joint
 - 150 mm
 - Bit holder
 - 72T
 - Hex key: 1.27x2, 1.5x2, 2.0x2, 2.5, 3.0 mm

- SL4, SL5, SL5.5, SL6, SL8
- PH1, PH2
- PZ1, PZ2
- T8, T10, T15, T20x2, T25x2, T27, T30
- TT8, TT10, TT15, TT20, TT25, TT27, TT30
- H3, H4, H5, H6
- TH3, TH4, TH5, TH6
- TRI-WING: 1, 2, 3
- TORQ: 6, 8, 10
- SPLINE: M5, M6, M8
- SQUARE: 1, 2
- Bit adapter: 1/4"

x144 1/4" 1/2" AS SYSTEM 72T CrMo CrV

HT1R440	1/4", 1/2"	1	3

DE Werkzeugsatz EN Tool set FR Kit d'outils ES Set de herramientas HR Garnitura alata HU Szerszámkészlet RO Trusa de scule BG Комплект инструменти



- | | | | |
|---|---|---|--|
| 4, 4.5, 5, 5.5, 6, 7, 8, 9, 10, 11, 12, 13, 14 mm
4, 5, 6, 7, 8, 9, 10 mm
E4, E5, E6, E7, E8
50, 100 mm
1/4"
115 mm
1/4"
1/4"
1/4", 72T
3, 4, 5, 6 mm
T8, T9, T10, T15, T20, T25, T27, T30
TT8, TT9, TT10, TT15, TT20, TT25, TT27, TT30
4, 5.5, 6.5, 7 mm
PH0, PH1, PH2
PZ0, PZ1, PZ2 | <p>1/4":</p> 10, 11, 12, 13, 14, 15 mm
E10, E11, E12, E14, E16, E18
21 mm
150 mm
3/8"
3/8"
3/8", 72T | <p>1/2":</p> 13, 14, 15, 16, 17, 18, 19, 20, 21, 22, 24, 27, 30, 32 mm
16, 17, 18, 19, 22 mm
E20, E22, E24
16 mm, 21 mm
Socket bit 1/2": T50, T70
1/2"
3 way adaptor 1/2"
125, 255 mm
1/2"
1/2", 72T
8, 9, 10, 11, 12, 13, 14, 15, 16, 17, 18, 19 mm | Screwdriver bits 5/16" 30 mm
5.5, 6, 6.5, 7, 8, 10, 12 mm
T27, T30, T35, T40, T45, T50
TT27, TT30, TT35, TT40, TT45, TT50
6, 6.5, 8 mm
PH3, PH4
PZ3, PZ4
M5, M6, M8, M10 mm
<p>Screwdriver bits 1/4" 25 mm:</p> M5, M6, M8
S1, S2
PH0, PH1, PH2, PH3
PZ0, PZ1, PZ2, PZ3
SL 4, 5.5, 6.5, 7
TT8, TT10, TT15, TT20, TT25, TT27, TT30, TT40, TT45
T0 6, 8, 10
HX2, 2.5, 3, 4, 5, 6, 7
SP 4, 6, 8, 10
TW 1, 2, 3, 4
Bit holder 1/4"
1.5, 2, 2.5, 3, 4, 5, 6 mm |
|---|---|---|--|

x215	1/4" 3/8" 1/2"	72T	CrMo	CrV
------	----------------------	-----	------	-----

HT1R458	1/4", 3/8", 1/2"	1	2	

DE Werkzeugsatz EN Tool set FR Kit d'outils ES Set de herramientas HR Garnitura alata HU Szerszámkészlet RO Trusa de scule BG Комплект инструменти



PL



EN



- 1/2":**
- 10, 11, 12, 13, 14, 15, 17, 19, 20, 21, 22, 24, 27, 30, 32 mm
 - 16, 17, 18, 19, 22 mm
 - E18, E20, E22, E24
 - 16, 21 mm
 - 125, 250 mm
 - Universal Joint
 - 3 way Adapter
 - Bits Socket: T55, T60
 - 72T
 - 8, 9, 10, 11, 12, 13, 14, 15, 16, 17, 18, 19 mm
 - 5/16"
- 3/8":**
- 10, 11, 12, 13, 14, 15, 16, 17, 18, 19 mm
 - 10, 11, 12, 13, 14, 15 mm
 - E8, E10, E12, E14, E16
 - 18 mm
 - 125 mm
 - Universal Joint
 - 5/16"
 - 72T

- 1/4":**
- 4, 4.5, 5, 5.5, 6, 7, 8, 9, 10, 11, 12, 13, 14 mm
 - D4, 5, 6, 7, 8, 9, 10 mm
 - 50, 100 mm
 - E4, E5, E6, E7, E8
 - Universal Joint
 - 115 mm
 - 72T
 - Hex Key Wrench: 1.27 mm x 2, 1.5 mm x 2, 2 mm x 2, 2.5 mm x 2, 3 mm x 2, 4 mm x 2, 5 mm
 - Bits holder
 - 1/4"
 - 1/4"
 - SL4, SL5.5, SL6.5, SL7 mm
 - PH1, PH2, PH3
 - PZ1, PZ2, PZ3
 - T8, T9, T10, T15, T20, T25, T27, T30
 - TT8, TT9, TT10, TT15, TT20, TT25, TT27, TT30
 - H3, H4, H5, H6
 - Bits 30 mm:

- T25, T27x2, T30x2, T35x2, T40x3, T45x2, T50x2
- H5.5, H6 x2, H7, H8
- SL6, SL6.5, SL8
- PH3, PH4
- PZ3, PZ4
- M5, M6, M8, M10
- Bits 25 mm:
- H3, H4, H5, H6
- H3, H4, H5, H6 (with hole)
- PH1, PH2
- PZ1, PZ2
- T8, T10, T15, T20, T25, T30, T40
- TT8, TT10, TT15, TT20, TT25, TT30, TT40
- M5, M6, M8
- SL4, SL5, SL6, SL8
- TRI. WING: 1, 2, 3
- TORQ: 6, 8, 10
- SQUARE: 1, 2
- SERVICE: 4, 6, 8

x222 1/4" 3/8" 1/2" AS SYSTEM 72T CrMo CrV

HT1R444	1/4", 3/8", 1/2"	1	2

DE Steckschlüsselsatz mit Umschaltknarre EN Sockets set with ratchet handle
FR Jeu de douilles + cliquet ES Juego llaves de vasos + carraca HR Račna s nasadnim ključevima HU Racsnis behajtó kar dugókulcsokkal RO Clichet cu chei tubulare BG Комплект тресчотка и вложки



Ratchet 1/2"
Sockets: 4, 5, 6, 7, 8, 9, 10,
11, 12, 13 mm

x10 1/2" 72T CrV CrMo

QUICK RELEASE ERGO GRIP

HT1R332	1/2"	5	10
---------	------	---	----

DE Steckschlüsselsatz mit Umschaltknarre EN Sockets set with ratchet handle
FR Jeu de douilles + cliquet ES Juego llaves de vasos + carraca HR Račna s nasadnim ključevima HU Racsnis behajtó kar dugókulcsokkal RO Clichet cu chei tubulare BG Комплект тресчотка и вложки



Ratchet 1/4"
Sockets: 4, 5, 6, 7, 8, 9, 10,
11, 12, 13 mm

x10 1/4" 72T CrV CrMo

QUICK RELEASE ERGO GRIP

HT1R334	1/4"	5	20
---------	------	---	----

DE Steckschlüsselsatz mit Umschaltknarre EN Sockets set with ratchet handle
FR Jeu de douilles + cliquet ES Juego llaves de vasos + carraca HR Račna s nasadnim ključevima kodiranim bojom HU Racsnis behajtó kar színkódos dugókulcsokkal RO Clichete cu chei tubulare cu cod color BG Комплект тресчотка и вложки



Ratchet 1/2"
Sockets: 10, 11, 12, 13, 14,
15, 17, 19, 22, 24 mm

x10 1/2" 72T CrV CrMo

QUICK RELEASE ERGO GRIP

HT1R382	1/2"	5	20
---------	------	---	----

DE Ring Ratschen Steckschlüssel Mit Teile EN Flexible head ratchet wrench with adapters
FR Clé à douille à cliquet ES Llaves De Trinquete HR Čegrtaljka s adapterima HU Ratchet csavkulcs RO Cheie cu clichet BG Тресчотка с адаптори



x5 1/4" x19mm 3/8" x19mm 1/2" x19mm

1/4" x19mm 72T CrV FLEXIBLE HEAD

HT1R395	1/4", 3/8", 1/2"	8	48
---------	------------------	---	----

DE Umschaltknarre mit Gelenkkopf EN Swivel Ratchet handle FR Poignée à cliquet pivotant ES Llave de carraca con mango giratorio HR Račna s okretnom ručicom HU Forgókaros racsnis behajtó kar RO Clichet cu maner rotativ BG Реверсивна тресчотка

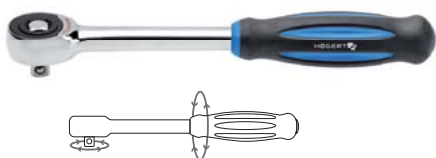

1/4" 60T CrV CrMo

QUICK RELEASE ERGO GRIP

HT1R374	1/4"	10	50
HT1R372	1/2"	5	20

DE Umschaltknarre EN Ratchet handle FR Poignée à cliquet ES Llave de carraca HR Račna HU Racsnis behajtó kar RO Maner cu clichet BG Тресчотка



1/4" 3/8" 1/2" 72T CrV CrMo

QUICK RELEASE ERGO GRIP STRAIGHT

HT1R304	1/4"	10	100
HT1R308	3/8"	10	50
HT1R302	1/2"	10	30

DE Umschaltknarre EN Ratchet handle FR Poignée à cliquet ES Llave de carraca HR Račna HU Racsnis behajtó kar RO Maner cu clichet BG Тресчотка



1/4" 3/8" 1/2" 72T CrV CrMo

QUICK RELEASE ERGO GRIP

HT1R324	1/4"	10	50
HT1R328	3/8"	5	30
HT1R322	1/2"	5	25

DE Umschaltknarre EN Ratchet handle FR Poignée à cliquet ES Llave de carraca HR Račna HU Racsnis behajtó kar RO Maner cu clichet BG Тресчотка



1/4" 1/2" 72T TPR CrMo

QUICK RELEASE ERGO GRIP

HT1R354	1/4"	12	72
HT1R352	1/2"	6	24



DE Teleskop-Umschaltknarre EN Telescopic ratchet handle FR Clé à Douille à Cliquet télescopique ES Llave de carraca telescópica HR Teleskopska račna HU Teleszkópos racsnis behajtó kar RO Clichet telescopic BG Телескопична тресчотка

DE Umschaltknarre EN Ratchet handle FR Poignée à cliquet ES Llave de carraca HR Račna HU Racsnis behajtó kar RO Maner cu clichet BG Тресчотка



1/2" 72 T 300-450 mm CrV

CrMo QUICK RELEASE ERGO GRIP

HT1R342	1/2"	5	25
---------	------	---	----

1/4" 72 T CrV CrMo ERGO GRIP

HT1R391	1/4"	10	100
---------	------	----	-----

DE Drehmomentschlüssel EN Torque wrench FR Clé dynamométrique ES Llave dinamométrica HR Momentni ključ HU Nyomaték kulcs RO Cheie dinamometrica BG Ключ динамометричен

DE Drehmomentschlüssel EN Torque wrench FR Clé dynamométrique ES Llave dinamométrica HR Momentni ključ HU Nyomaték kulcs RO Cheie dinamometrica BG Ключ динамометричен



24 T ± 4% CrV

HT1W701	1/4"	5-25 Nm	1	12
HT1W706	1/2"	20-110 Nm	1	12
HT1W707	1/2"	40-210 Nm	1	12
HT1W708	1/2"	50-350 Nm	1	12

72 T ± 3% CrMo

HT1W710	1/4"	5-25 Nm	255 mm	1	6
HT1W711	3/8"	10-60 Nm	320 mm	1	6
HT1W712	1/2"	20-120 Nm	435 mm	1	6
HT1W713	1/2"	40-220 Nm	515 mm	1	6
HT1W714	1/2"	80-330 Nm	595 mm	1	6

DE Drehgriff Typ „T“ für Steckschlüssel und Schrauber-bits EN Sliding T-handle for sockets and screwdriver bits FR Poignée en T coulissante pour douilles et embouts ES Llave "T" para llaves de vaso y puntas para atornillar HR T-drška za nasadne ključeve i bitove odvijača HU Csúsztható T-markolat dugókulcsokhoz RO Maner glisant tip T pentru chei tubulare BG Бит държач, T - образен, регулируем

DE Spinner Griff EN Spinner handle FR Rallonge avec manche ES Destornillador para llaves de vaso HR Okretna ručka za nasadne ključeve HU Dugókulcs behajtó kar RO Adapter pentru chei tubulare BG Отвертка за вложки



1/4" 2 in 1 S2 STEEL ADJUSTABLE

HT1W879	1/4"	1	60
---------	------	---	----



1/4" CrV ERGO GRIP

HT1S203	150 mm	10	100
---------	--------	----	-----

DE Verlängerung für Steckschlüssel EN Extension bar FR Rallonge de clé ES Alargador HR Produžetak za nasadne ključeve HU Hosszabbító kar RO Extensie BG Удължител за вложки

DE Verlängerung für Steckschlüssel EN Extension bar FR Rallonge de clé ES Alargador HR Produžetak za nasadne ključeve HU Hosszabbító kar RO Extensie BG Удължител за вложки



1/4" CrV DIN 3123

HT1A701	50 mm	50	500
HT1A702	76 mm	40	400
HT1A703	100 mm	25	250
HT1A705	152 mm	20	200

3/8" CrV DIN 3123

HT1A714	127 mm	20	80
---------	--------	----	----

DE Verlängerung für Steckschlüssel EN Extension bar FR Rallonge de clé ES Alargador
HR Produžetak za nasadne ključeve HU Hosszabbító kar RO Extensie BG Удължител
за вложки



Folder	Length	Weight	Quantity
HT1A724	125 mm	20	100
HT1A727	250 mm	10	40

1/2" CrV DIN 3123

DE Elastische Verlängerung für Steckschlüssel EN Flexible extension bar FR Rallonge
de clé ES Alargador flexible HR Produžetak za nasadne ključeve, fleksibilan
HU Mechanikai szerszámok RO Extensie flexibilă BG Удължител за вложки, гъвкав



Folder	Length	Weight	Quantity
HT1A740	150 mm	20	200

1/4" FLEXI-
BLE CrV

DE L-Knarre für Steckschlüssel EN Handle for wrench socket L-shape FR Cle Type L
ES Llave tipo L HR Okretna ručka L-tipa HU L-alakú toldó markolat RO Chei tubulare
cu maner de prelungire tip L BG Г-образен върток за вложки



Folder	Length	Weight	Quantity
HT1A792	250 mm	10	40

1/2" CrV DIN 3122

DE Drehgriff Typ "T" EN Sliding T-bar FR Poignee coulissante en T ES Mango deslizante
en T HR Okretna ručka T-tipa HU Csúsztatható T-rúd RO Bara tip T glisant BG Върток
за вложка тип T



Folder	Length	Weight	Quantity	
HT1A745	1/4"	152 mm	25	200
HT1A747	1/2"	255 mm	10	50

1/4" CrV DIN 3122

DE Steckschlüssel-Hebel mit Gelenk EN Flexible handle FR Rallonge de clé Flexible
ES Alargador de llave flexible HR Nagibna okretna ručka HU Rugalmas markolat
RO Maner flexibil BG Върток за вложка с плъзгаща дръжка



Folder	Length	Weight	Quantity
HT1A763	380 mm	5	200
HT1A764	457 mm	5	200

1/2" CrV DIN 3121

DE Verlängerung für Steckschlüssel EN Universal joint FR Joint universel ES Adaptador
Vaso Universal HR Univerzalni spoj za nasadne ključeve HU Univerzális csatlakozó
elem dugókulcsokhoz RO Legatura universala pentru chei tubulare BG Кардан за
вложка



Folder	Length	Weight	Quantity
HT1A755	1/4"	25	500
HT1A756	3/8"	20	200
HT1A757	1/2"	25	200

1/4" CrV DIN 3123

DE Adapter EN Socket adapter FR Adaptateur douille ES Adaptador para vasos
HR Adapter HU Adapter RO Adapter BG Адаптор



Folder	Size	Weight	Quantity
HT1A770	F1/4" x M3/8"	50	500
HT1A771	F3/8" x M1/4"	25	250
HT1A772	F3/8" x M1/2"	25	250
HT1A773	F1/2" x M3/8"	20	200
HT1A774	F1/2" x M3/4"	10	100
HT1A775	F3/4" x M1/2"	10	100

CrV DIN 3121

DE Sechskantsteckschlüssel EN Socket, hexagon metric FR Douille hexagonale
ES Llave de vaso hexagonal HR Šesterokutni nasadni ključ HU Hatszög dugókulcs
RO Chei tubulare hexagonale BG Вложка шестостенна

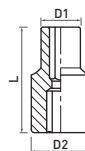

Folder	mm	D1	D2	L	Weight	Quantity
HT1A002	4	6,8	11,8	25	25	500
HT1A003	4,5	7,2	11,8	25	25	500
HT1A004	5	8	11,8	25	25	500
HT1A005	5,5	8,5	11,8	25	25	500
HT1A006	6	9,2	11,8	25	25	500
HT1A007	7	10,8	11,8	25	25	500
HT1A008	8	11,8	11,8	25	25	500
HT1A009	9	12,8	12,8	25	25	500
HT1A010	10	14,5	14,5	25	20	400
HT1A011	11	15,8	15,8	25	25	500
HT1A012	12	16,8	16,8	25	20	400
HT1A013	13	17,8	17,8	25	20	400
HT1A014	14	19,8	19,8	25	20	400

1/4" 6 PT AS SYSTEM

CrV DIN 3124

DE Sechskantsteckschlüssel lang EN Socket, hexagon metric, deep FR Douille Hexagonale allongée ES Llave de vaso hexagonal larga HR Šesterokutni nasadni ključ HU Hatszög dugókulcs RO Chei tubulare hexagonale BG Вложка шестостенна, дълга

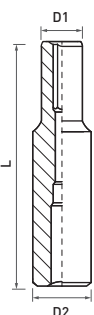

Folder	Ø	D1	D2	L	Box	Box
HT1A156	6 mm	10,3 mm	16,8 mm	64 mm	30	240
HT1A157	7 mm	10,8 mm	16,8 mm	64 mm	30	240
HT1A158	8 mm	12 mm	16,8 mm	64 mm	30	240
HT1A159	9 mm	13,3 mm	16,8 mm	64 mm	30	240
HT1A160	10 mm	14,5 mm	16,8 mm	64 mm	30	240
HT1A161	11 mm	16,8 mm	16,8 mm	64 mm	30	240
HT1A162	12 mm	17,8 mm	17,8 mm	64 mm	30	240
HT1A163	13 mm	18,8 mm	18,8 mm	64 mm	30	240
HT1A164	14 mm	19,8 mm	19,8 mm	64 mm	25	200
HT1A165	15 mm	21,8 mm	21,8 mm	64 mm	20	160
HT1A166	16 mm	21,8 mm	21,8 mm	64 mm	20	160
HT1A167	17 mm	23,8 mm	23,8 mm	64 mm	15	120
HT1A168	18 mm	25,8 mm	25,8 mm	64 mm	15	120
HT1A169	19 mm	25,8 mm	25,8 mm	64 mm	15	120
HT1A170	20 mm	27,8 mm	27,8 mm	64 mm	10	80
HT1A171	21 mm	27,8 mm	27,8 mm	64 mm	10	80

3/8" 6 PT DEEP
AS SYSTEM CrV DIN 3124

DE Sechskantsteckschlüssel EN Socket, hexagon metric FR Douille 6 pans ES Llave de vaso hexagonal HR Šesterokutni nasadni ključ HU Hatszög dugókulcs RO Chei tubulare hexagonale BG Вложка шестостенна

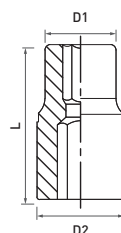

Folder	Ø	D1	D2	L	Box	Box
HT1A208	8 mm	13,7 mm	21,8 mm	38 mm	20	200
HT1A209	9 mm	14,2 mm	21,8 mm	38 mm	20	200
HT1A210	10 mm	15,3 mm	21,8 mm	38 mm	20	200
HT1A211	11 mm	16,5 mm	21,8 mm	38 mm	20	200
HT1A212	12 mm	17,8 mm	21,8 mm	38 mm	20	200
HT1A213	13 mm	19,0 mm	21,8 mm	38 mm	20	200
HT1A214	14 mm	20,3 mm	21,8 mm	38 mm	20	200
HT1A215	15 mm	21,8 mm	20,5 mm	38 mm	20	200
HT1A216	16 mm	21,8 mm	20,5 mm	38 mm	20	200
HT1A217	17 mm	23,8 mm	21,8 mm	38 mm	20	200
HT1A218	18 mm	25,8 mm	22,8 mm	38 mm	10	200
HT1A219	19 mm	25,8 mm	22,8 mm	38 mm	10	100
HT1A220	20 mm	27,8 mm	23,8 mm	38 mm	10	100
HT1A221	21 mm	27,8 mm	23,8 mm	38 mm	20	200
HT1A222	22 mm	29,8 mm	26 mm	38 mm	10	100
HT1A223	23 mm	31,8 mm	28 mm	39 mm	20	200
HT1A224	24 mm	31,8 mm	28 mm	39 mm	10	100
HT1A227	27 mm	35,8 mm	30 mm	42 mm	5	50
HT1A230	30 mm	39,8 mm	34 mm	44 mm	5	50
HT1A232	32 mm	41,8 mm	36 mm	44 mm	5	50
HT1A236	36 mm	45,8 mm	48 mm	44 mm	5	50

1/2" 6 PT AS SYSTEM
CrV DIN 3124

DE Sechskantsteckschlüssel EN Socket, hexagon metric FR Douille 6 pans ES Llave de vaso HR Šesterokutni nasadni ključ HU Hatszög dugókulcs RO Chei tubulare hexagonale BG Вложка шестостенна

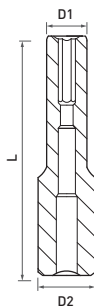

Folder	Ø	D1	D2	L	Box	Box
HT1A258	8 mm	14,8 mm	21,8 mm	78 mm	20	160
HT1A259	9 mm	15,3 mm	21,8 mm	78 mm	20	160
HT1A260	10 mm	15,3 mm	21,8 mm	78 mm	20	160
HT1A261	11 mm	16,5 mm	21,8 mm	78 mm	20	160
HT1A262	12 mm	17,8 mm	21,8 mm	78 mm	20	160
HT1A263	13 mm	19,0 mm	21,8 mm	78 mm	15	120
HT1A264	14 mm	20,0 mm	21,8 mm	78 mm	15	120
HT1A265	15 mm	21,8 mm	21,8 mm	78 mm	15	120
HT1A266	16 mm	21,8 mm	21,8 mm	78 mm	15	120
HT1A267	17 mm	23,8 mm	23,8 mm	78 mm	15	120
HT1A268	18 mm	25,8 mm	25,8 mm	78 mm	15	120
HT1A269	19 mm	25,8 mm	25,8 mm	78 mm	15	120
HT1A270	20 mm	27,8 mm	27,8 mm	78 mm	10	80
HT1A271	21 mm	27,8 mm	27,8 mm	78 mm	10	80
HT1A272	22 mm	29,8 mm	29,8 mm	78 mm	10	80
HT1A273	23 mm	31,8 mm	31,8 mm	78 mm	10	80
HT1A274	24 mm	31,8 mm	31,8 mm	78 mm	10	80
HT1A277	27 mm	35,8 mm	35,8 mm	78 mm	8	64
HT1A280	30 mm	39,8 mm	39,8 mm	78 mm	6	48
HT1A282	32 mm	41,8 mm	41,8 mm	78 mm	6	48

1/2" 6 PT DEEP
AS SYSTEM CrV DIN 3124

DE Steckschlüssel Spline EN Spline socket FR Douille spline 1/2", 8 mm, ES Llave de vaso Spline 1/2", 8 mm, CrV50BV30, DIN 3121 HR Nasadni ključ spline HU Spline dugókulcsok RO Chei tubulare spline BG Вложка тип Spline

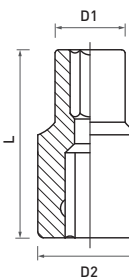

Folder	Ø	D1	D2	L	Box	Box
HT1A408	8 mm	13,7 mm	21,8 mm	38 mm	20	200
HT1A409	9 mm	14,2 mm	21,8 mm	38 mm	20	200
HT1A410	10 mm	15,3 mm	21,8 mm	38 mm	20	200
HT1A411	11 mm	16,5 mm	21,8 mm	38 mm	20	200
HT1A412	12 mm	17,8 mm	21,8 mm	38 mm	20	200
HT1A413	13 mm	19,0 mm	21,8 mm	38 mm	20	200
HT1A414	14 mm	20,3 mm	21,8 mm	38 mm	20	200
HT1A415	15 mm	21,8 mm	20,5 mm	38 mm	20	200
HT1A416	16 mm	21,8 mm	20,5 mm	38 mm	20	200
HT1A417	17 mm	23,8 mm	21,8 mm	38 mm	20	200
HT1A418	18 mm	25,8 mm	22,8 mm	38 mm	10	100
HT1A419	19 mm	25,8 mm	22,8 mm	38 mm	10	100
HT1A420	20 mm	27,8 mm	23,8 mm	38 mm	10	100
HT1A421	21 mm	29,8 mm	26,0 mm	38 mm	10	100
HT1A422	22 mm	29,8 mm	26,0 mm	38 mm	10	100
HT1A423	23 mm	31,8 mm	28,0 mm	38 mm	10	100
HT1A424	24 mm	33,8 mm	28,5 mm	40 mm	10	100
HT1A427	27 mm	35,8 mm	30,0 mm	42 mm	5	50
HT1A430	30 mm	39,8 mm	34,0 mm	44 mm	5	50
HT1A432	32 mm	41,8 mm	36,0 mm	44 mm	5	50

1/2" SPLINE CrV
DIN 3124

DE Sechskant Zündkerzensteckschlüssel EN Hexagon spark plug socket FR Douille pour bougie ES Llave de vaso HR Nasadni ključ za svjeće HU Gyújtógyertya kulcs RO Chei pentru bujii BG Вложка шестостенна за свещи

DE Sechskant Zündkerzensteckschlüssel EN Hexagon spark plug socket FR Douille pour bougies d'allumage ES Vaso bujía HR Nasadni ključ za svjeće HU Gyújtógyertya kulcs RO Chei tubulare pentru bujii BG Вложка за свещи

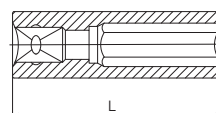
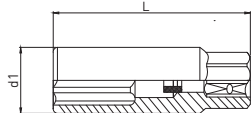

3/8"	6 PT	CrV	DIN 3120			D1	L		
HT1A779	16 mm	21,8 mm	64 mm	20	160				

1/2"	6 PT	CrV	DIN 3120			D1	L		
HT1A783	16 mm	21,8 mm	64 mm	20	200				
HT1A785	21 mm	27,8 mm	65 mm	10	100				

DE Steckschlüsselsatz EN Deep socket set FR Jeu de douilles ES Llaves de vaso HR Komplet šesterokutnih nasadnih ključeva HU Hatszög dugókulcs készlet RO Set de chei tubulare hexagonale BG Комплект вложки

DE Steckschlüsselsatz EN Deep socket set FR Jeu de douilles ES Llaves de vaso HR Komplet šesterokutnih nasadnih ključeva HU Hatszög dugókulcs készlet RO Set de chei tubulare hexagonale BG Комплект вложки



5,5, 6, 7, 8, 9, 10, 12, 13 mm

10, 12, 13, 14, 15, 17, 19, 21, 22, 24 mm

x8	1/4"	6 PT	DEEP
----	------	------	------

x10	1/2"	6 PT	DEEP
-----	------	------	------

AS SYSTEM	CrV	DIN 3124				
HT1A886	50 mm	5	40			

AS SYSTEM	CrV	DIN 3124				
HT1A888	76 mm	5	10			

DE Spitzenset torx EN Torx bit socket set FR Kit de torx ES Juego de Llaves torx HR Komplet nasadnih ključeva torx HU Torx dugókulcs készlet RO Set de chei tubulare torx BG Комплект вложки тип torx

DE Spitzenset torx EN Torx bit socket set FR Kit de torx ES Juego de Llaves torx HR Komplet nasadnih ključeva torx HU Torx dugókulcs készlet RO Set de chei tubulare torx BG Комплект вложки тип torx



1/4": E5, E6, E7, E8
 3/8": E10, E12, E14, E16
 1/4" M x 3/8" F

1/2": E10, E11, E12, E14, E16, E18, E20, E22, E24

x9	3/8"	1/4"	TORX	CrV				
HT1A884	E5-E16	5	20					

x9	1/2"	TORX	CrV				
HT1A880	E10-E24	5	20				

DE Adapter für Bits EN Bit adapter FR Adaptateur de bit ES Adaptador de punta de HR Adapter za bitove HU Bitfej adapter RO Adapter pentru biti BG Адаптор за битове

DE PH Stiftschlüssel EN PH Impact bit socket FR Clef mâle PH ES Llave de vaso con punta PH HR Držac bitova PH HU PH pneumatikus bitfej készlet RO Biti de impact PH BG Бит вложка PH

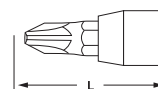

1/4"	CrV				
HT1A752	1/4"	25	500		

PH	1/4"	CrV				
S2	HRC 58-60	DIN 3120				
HT1S601	PH1	37 mm	50	400		
HT1S602	PH2	37 mm	50	400		
HT1S603	PH3	37 mm	50	400		

DE PZ Stiftschlüssel EN PH Impact bit socket FR Clef mâle PZ ES Llave de vaso con punta PZ HR Držac bitova PZ HU PZ pneumatikus bitfej készlet RO Biti de impact PZ BG Бит вложка PZ

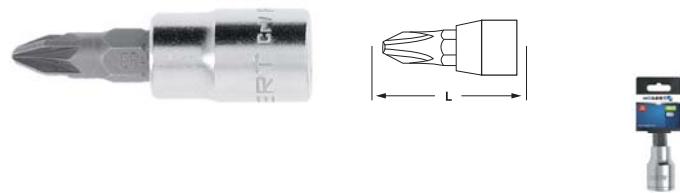

⊕ PZ 1/4" CrV
S2 HRC 58-60 DIN 3120

Folder	Symbol	L	Box	Carton
HT1S606	PZ1	37 mm	50	400
HT1S607	PZ2	37 mm	50	400
HT1S608	PZ3	37 mm	50	400

DE Bit-Stecknüsse Hex EN Hex bit socket FR Embout de tournevis Hex ES Llave de vaso con punta hexagonal HR Držac bitova hex HU Hex bitfej kulcsok RO Biti hex BG Бит вложка HEX

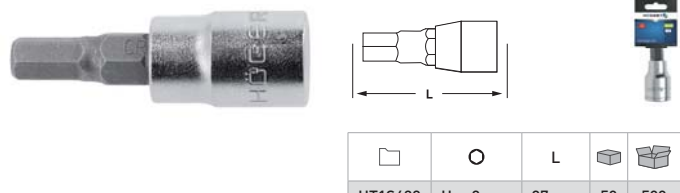

HEX 1/4" CrV S2
HRC 58-60 DIN 3120

Folder	Symbol	L	Box	Carton
HT1S623	Hex 3 mm	37 mm	50	500
HT1S624	Hex 4 mm	37 mm	50	500
HT1S625	Hex 5 mm	37 mm	50	500
HT1S626	Hex 6 mm	37 mm	50	500
HT1S627	Hex 7 mm	37 mm	50	500
HT1S628	Hex 8 mm	37 mm	50	500

DE Torx-Stiftschlüssel EN Torx bit socket FR Clef mâle ES Llave de vaso con punta HR Držac bitova torx HU Torx bitfej dugókulcs RO Biti Torx BG Бит вложка torx

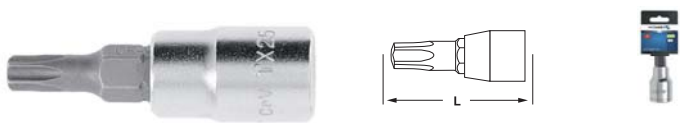

TORX 1/4" CrV S2
HRC 58-60 DIN 3120

Folder	Symbol	L	Box	Carton
HT1S640	T8	37 mm	50	500
HT1S642	T10	37 mm	50	500
HT1S643	T15	37 mm	50	500
HT1S644	T20	37 mm	50	500
HT1S645	T25	37 mm	50	500
HT1S646	T27	37 mm	50	600
HT1S647	T30	37 mm	50	600
HT1S648	T40	37 mm	50	600
HT1S649	T45	37 mm	50	600

DE Bit-Stecknüsse Tamper-torx EN Torx security socket bit FR Embout de tournevis torx ES Llave de vaso con punta torx HR Držac bitova Tamper torx HU Tamper Torx bitfej dugókulcs RO Biti Tamper torx BG Бит вложка torx security



TAMPER TORX 1/4" CrV S2
HRC 58-60 DIN 3120

Folder	Symbol	L	Box	Carton
HT1S670	TT6	37 mm	50	300
HT1S671	TT7	37 mm	50	300
HT1S672	TT8	37 mm	50	500
HT1S673	TT9	37 mm	50	300
HT1S674	TT10	37 mm	50	500
HT1S675	TT15	37 mm	50	500
HT1S676	TT20	37 mm	50	400
HT1S677	TT25	37 mm	50	400
HT1S678	TT27	37 mm	50	500
HT1S679	TT30	37 mm	50	400
HT1S680	TT40	37 mm	50	500

DE Sechskant-Stiftschlüssel EN Hex bit socket FR Clef mâle hex ES Llave de vaso con punta hex HR Držac bitova hex HU Hex bitfej dugókulcs RO Biti Hex BG Бит вложка HEX



HEX 1/2" CrV S2
HRC 58-60 DIN 3120

Folder	Symbol	L	Box	Carton
HT1S724	H4	55 mm	50	500
HT1S725	H5	55 mm	50	500
HT1S726	H6	55 mm	50	500
HT1S727	H7	55 mm	50	500
HT1S728	H8	55 mm	50	500
HT1S729	H10	55 mm	50	600
HT1S730	H12	55 mm	50	600
HT1S731	H14	55 mm	50	600
HT1S732	H17	55 mm	50	600

DE Torx-Stiftschlüssel EN Torx bit socket FR Clef mâle torx ES Llave de vaso con punta torx HR Držac bitova torx HU Torx bitfej dugókulcs RO Biti torx BG Бит вложка torx

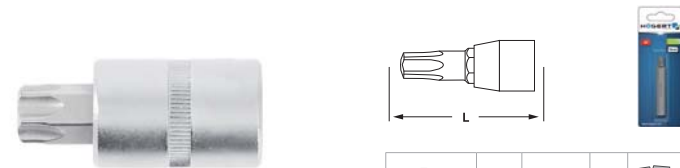

TORX 1/2" CrV S2
HRC 58-60 DIN 3120

Folder	Symbol	L	Box	Carton
HT1S746	T20	55 mm	20	240
HT1S747	T25	55 mm	20	240
HT1S748	T27	55 mm	20	240
HT1S749	T30	55 mm	20	240
HT1S750	T40	55 mm	20	240
HT1S751	T45	55 mm	20	240
HT1S752	T50	55 mm	20	240
HT1S753	T55	55 mm	20	240
HT1S754	T60	55 mm	20	160
HT1S755	T70	55 mm	20	160

DE Spline-Stiftschlüssel EN Spline bit socket FR Clef mâle spline ES Llave de vaso con punta spline HR Držac bitova spline HU Spline bitfej dugókulcs RO Biti spline BG Бит вложка spline

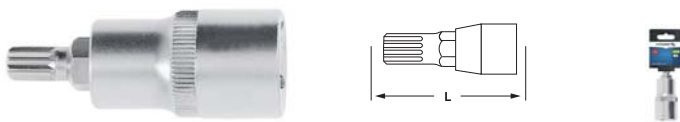

SPLINE 1/2" CrV S2
HRC 58-60 DIN 3120

Folder	Symbol	L	Box	Carton
HT1S785	M5	55 mm	20	240
HT1S786	M6	55 mm	20	240
HT1S788	M8	55 mm	20	240
HT1S790	M10	55 mm	20	240
HT1S792	M12	55 mm	20	240
HT1S794	M14	55 mm	20	240
HT1S796	M16	55 mm	20	240
HT1S797	M17	55 mm	20	240

DE Sechskant-Stiftschlüssel EN Hex bit socket FR Clef mâle hex ES Llave de vaso con punta HR Držac bitova hex HU Hex bitfej dugókulcs RO Biti hex BG Бит вложка hex



HEX 1/2" CrV S2
HRC 58-60 DIN 3120

Folder	Symbol	L	Box	Carton
HT1S524	H4	100 mm	20	120
HT1S525	H5	100 mm	20	120
HT1S526	H6	100 mm	20	120
HT1S527	H7	100 mm	20	120
HT1S528	H8	100 mm	20	120
HT1S529	H10	100 mm	20	120
HT1S530	H12	100 mm	20	120
HT1S531	H14	100 mm	20	120
HT1S532	H17	100 mm	16	64

DE Torx-Stiftschlüssel EN Torx bit socket FR Clef mâle torx ES Llave de vaso con punta torx HR Držač bitova torx HU Torx bitfej dugókulcs RO Biti torx BG Бит вложка torx

DE Spline-Stiftschlüssel EN Spline bit socket FR Clef mâle spline ES Llave de vaso con punta spline HR Držač bitova spline HU Spline bitfej dugókulcs RO Biti Spline BG Бит вложка spline

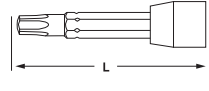
Folder	Bit	L	Box	Box
HT1S546	T20	100 mm	20	120
HT1S547	T25	100 mm	20	120
HT1S548	T27	100 mm	20	120
HT1S549	T30	100 mm	20	120
HT1S550	T40	100 mm	20	120
HT1S551	T45	100 mm	20	120
HT1S552	T50	100 mm	20	120
HT1S553	T55	100 mm	20	120
HT1S554	T60	100 mm	20	120
HT1S555	T70	100 mm	20	120

TORX 1/2" CrV S2

HRC 58-60 DIN 3120

Folder	Bit	L	Box	Box
HT1S585	M5	100 mm	20	120
HT1S586	M6	100 mm	20	120
HT1S588	M8	100 mm	20	120
HT1S590	M10	100 mm	20	120
HT1S592	M12	100 mm	20	120
HT1S594	M14	100 mm	20	120
HT1S596	M16	100 mm	16	64
HT1S597	M17	100 mm	16	64

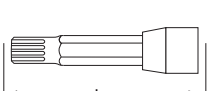
SPLINE 1/2" CrV S2

HRC 58-60 DIN 3120

DE Schrauberbit-Satz EN Screwdriver bits set FR Coffret d'embouts ES Set puntas de atornillar HR Komplet bitova odvijača HU Csavarhúzó bitfej készlet RO Set de biti surubelnita BG Комплект бит вложки

DE Schrauberbit-Satz EN Screwdriver bits set FR Coffret d'embouts ES Set puntas de atornillar HR Komplet bitova odvijača HU Csavarhúzó bitfej készlet RO Set de biti surubelnita BG Комплект бит вложки



⊖ SL4, SL5,5, SL7 mm
⊕ PH0, PH1, PH2, PH3
⊕ PZ0, PZ1, PZ2, PZ3
● T10, T15, T20, T25, T30
Magnetic holder 1/4"

Folder	Bit	Box	Box
HT1S401	1/4"	12	48

x17 1/4" S2



⊖ 3, 4, 5, 6
⊕ PH1, PH2, PH3, PH4
⊕ PZ1, PZ2, PZ3
○ H3, H4, H5, H6
● T10, T15, T20, T25, T27, T30, T40
● T10, T15, T20, T25, T27, T30, T40
Adapter for sockets
Magnetic handle

Folder	Bit	Box	Box
HT1S400	1/4"	20	40

x32 1/4" SLIM S2

DE Schrauberbit-Satz EN Screwdriver bits set FR Coffret d'embouts ES Set puntas de atornillar HR Komplet bitova odvijača HU Csavarhúzó bitfej készlet RO Set de biti surubelnita BG Комплект бит вложки

DE Schrauberbit-Satz mit Ratsche EN Screwdriver bits set FR Set d'embouts de tournevis ES Juego de puntas de destornilladores HR Komplet bitova odvijača HU Csavarhúzó bitfej készlet RO Set de biti surubelnita BG Комплект бит вложки с тресчотка



⊖ SL3, SL4, SL5, SL5,5, SL6,5 mm
⊕ PH1, PH2 x 2, PH3
⊕ PZ1, PZ2 x 2, PZ3
● T8, T9, T10, T15 x 2, T20 x 2, T25 x 2, T30, T40
○ H2, H2,5, H3, H4, H5, H6
Adapter for 1/4" sockets
Magnetic holder 1/4"

Folder	Bit	Box	Box
HT1S402	1/4"	12	48

x33 1/4" SLIM S2



⊖ 3, 4, 5, 6
⊕ PH1, PH2 x 2, PH3
⊕ PZ1, PZ2 x 2, PZ3
○ H3, H4, H5, H6
● T10, T15, T20, T25, T27, T30, T40
● T10, T15, T20, T25, T27, T30, T40
Adapter for sockets
Ratchet 1/4", 52T

Folder	Bit	Box	Box
HT1R460	1/4"	5	50

x33 1/4" SLIM S2 52T

DE Schrauberbit-Satz EN Screwdriver bits set FR Coffret d'embouts ES Set puntas de atornillar HR Komplet bitova odvijača HU Csavarhúzó bitfej készlet RO Set de biti surubelnita BG Комплект бит вложки

DE Bithalter EN Magnetic bit holder FR Porte-embout magnétique ES Adaptador magnético para puntas HR Magnetska ručka HU Mágneses markolat RO Maner magnetic BG Бит държач магнитен



⊕ PH0, PH1 x 2, PH2 x 2, PH3
⊕ PZ0, PZ1 x 3, PZ2 x 3, PZ3
⊖ SL3, SL4, SL5, SL6, SL7
● T10, T15, T20, T25, T27, T30, T40
● TT10, TT15, TT20, TT25, TT27, TT30, TT40
○ H2, H3, H4, H5, H6
● M5, M6, M8
Tri Wing: 1, 2, 3
Square: S0, S1, S2, S3
Service: 4, 6, 8

Folder	Bit	Box	Box
HT1R461	1/4"	5	50

x50 1/4" S2



Folder	Bit	Box	Box
HT1S438	60 mm	10	200

1/4" CrV Al MAGNETIC

DE Bithalter EN Magnetic bit holder FR Porte-embout ES Adaptador para puntas
HR Magnetska ručka HU Mágneses markolat RO Maner magnetic BG Бит държач
магнитен



1/4"	CrV	MAGNETIC				
HT1S439	60 mm	5	250			

DE Bithalter EN Magnetic bit holder FR Porte-embout ES Adaptador para puntas
HR Magnetska ručka HU Mágneses markolat RO Maner magnetic BG Бит държач
магнитен



1/4"	CrV	Al	MAGNETIC			
HT1S440	60 mm	50	250			

DE Aluminium Bithalter EN Aluminium bit holder FR Porte-embout Aluminium
ES Soporte para puntas de destornillador HR SLIM Magnetska ručka HU SLIM
mágneses markolat RO Maner magnetic SLIM BG Бит държач магнитен SLIM



1/4"	SLIM 9.2 mm	CrV	Al	MAGNETIC			
HT1S441	78 mm	10	200				

DE Bohrfutter-Adapter für Nüsse EN Socket bit adapters FR Adaptateurs de douille
ES Adaptador para llaves de vaso HR Ručka za nasadne ključeve HU Dugókulcs
markolat RO Maner pentru biti tubulari BG Адаптор за вложки, бормашина



1/4"	1/4" 3/8" 1/2"	65 mm	75 mm	CrV			
HT1S445	1/4" 1/4" 1/4"	65 mm 65 mm 75 mm	10	100			

DE Aluminium Bithalter EN Aluminium bit holder FR Porte-embout ES Soporte para
puntas de destornillador HR Magnetska ručka s pokretnim ovratnikom HU Mágneses
adapter mozgatható peremmel RO Adapter magnetic cu flansa mobila BG Бит
държач магнитен движим



1/4"	CrV	Al	MAGNETIC			
HT1S442	76-118 mm	10	200			

DE Adapter für Nüsse EN Socket bit adapters FR Adaptateurs de douille ES Adaptador
para llaves de vaso HR Držać za nasadne ključeve HU Bithegy-tartó RO Adaptor pentru
biti BG Адаптор за вложки



1/2"	DRIVE END 1/4"	CrV	BALL-END	ALU GRIP 360°			
HT1S446	100 mm	10	100				

DE Steckschlüsseinsatz magnetisch EN Magnetic sockets FR Douilles magnétiques
ES Llave de vaso imantada HR Magnetski nasadni ključ HU Mágneses dugókulcs
RO Soclu magnetic BG Магнитна вложка



1/4"	48 mm	x2	CrV	MAGNETIC			
HT1S457	8 mm	10	100				
HT1S458	10 mm	10	100				
HT1S459	12 mm	10	100				
HT1S460	13 mm	10	100				

DE Gipskartonplatten Schraubendreher Spitzen PH EN Screwdriver bit, gypsum
board FR Pack de embouts pour plâtre ES Pack de uds de Punta de atornillar HR Bitovi
odvijača za G-K ploče HU PH2 csavarhúzó bitefejek gipszkartonhoz RO Biti surubelnita
PH2 pentru gips carton BG Битове за гипсокартон



PH2	1/4"	x2	S2	DIN ISO 2351-2			
HT1S432	PH2	25 mm	10	100			



DE Schraubenerbits Philips PH EN Screwdriver bit FR Embouts tournevis PH ES Puntas de destornillador PH HR Bitovi odvijača PH HU PH csavarhúzó bitfejek RO Biti surubelnita PH BG Бит с магнитен държач



⊕	PH2	1/4"	x2	S2
HRC	58-60	MAGNETIC	DIN	3126

Folder	⊕	L	Box	Box
HT1S305	PH2	65 mm	10	100

DE Schraubendreherstippen PH EN PH screwdriver bit FR Embout PH ES Punta de atornillar PH HR Bitovi odvijača PH HU PH csavarhúzó bitfejek RO Biti surubelnita PH BG Бит накрайки PH

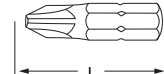

⊕	PH	1/4"	x5	ARC anty-slip
S2	HRC	58-60	DIN	3126

Folder	⊕	L	Box	Box
HT1S300	PH0	25 mm	10	100
HT1S301	PH1	25 mm	10	100
HT1S302	PH2	25 mm	10	100
HT1S303	PH3	25 mm	10	100

DE Schraubendreherstippen PH EN PH screwdriver bit FR Embout PH ES Punta de atornillar PH HR Bitovi odvijača PH HU PH csavarhúzó bitfejek RO Biti surubelnita PH BG Бит накрайки PH

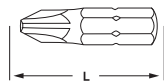

⊕	PH	1/4"	x10	
S2	HRC	58-60	DIN	3126

Folder	⊕	L	Box	Box
HT1S304	PH2	25 mm	10	100

DE Schraubendreherstippen PH EN PH screwdriver bit FR Embout PH ES Punta de atornillar PH HR Bitovi odvijača PH HU PH csavarhúzó bitfejek RO Biti surubelnita PH BG Битове накрайници PH

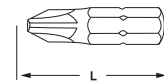

⊕	PH	1/4"	x5	SLIM	
TiN COATED	S2	HRC	58-60	DIN	3126

Folder	⊕	L	Box	Box
HT1S382	PH2	25 mm	10	100

DE Schraubendreherstippen PZ EN PZ screwdriver bit FR Embout PZ ES Punta de atornillar PZ HR Bitovi odvijača PZ HU PZ csavarhúzó bitfejek RO Biti surubelnita PZ BG Бит накрайки PZ

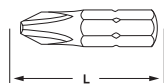

⊕	PZ	1/4"	x5	ARC anty-slip
S2	HRC	58-60	DIN	3126

Folder	⊕	L	Box	Box
HT1S307	PZ0	25 mm	10	100
HT1S314	PZ1	25 mm	10	100
HT1S315	PZ1	25 mm	10	100
HT1S316	PZ3	25 mm	10	100

DE Schraubendreherstippen PZ EN PZ screwdriver bit FR Embout PZ ES Punta de atornillar PZ HR Bitovi odvijača PZ HU PZ csavarhúzó bitfejek RO Biti surubelnita PZ BG Бит накрайки PZ

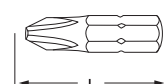

⊕	PZ	1/4"	x10	
S2	HRC	58-60	DIN	3126

Folder	⊕	L	Box	Box
HT1S317	PH2	25 mm	10	100

DE Schraubendreherstippen PZ EN PZ screwdriver bit FR Embout PZ ES Punta de atornillar PZ HR Bitovi odvijača PZ HU PZ csavarhúzó bitfejek RO Biti surubelnita PZ BG Битове накрайници PZ

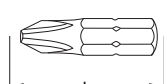

⊕	PZ	1/4"	x5	S2	
SLIM	TiN COATED	HRC	58-60	DIN	3126

Folder	⊕	L	Box	Box
HT1S384	PZ1	25 mm	10	100
HT1S385	PZ2	25 mm	10	100
HT1S386	PZ3	25 mm	10	100

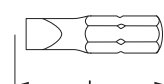

DE Schraubendreherstippen SL EN SL screwdriver bit FR Embout SL ES Punta de atornillar SL HR Bitovi odvijača SL HU SL csavarhúzó bitfejek RO Biti surubelnita SL BG Бит накрайки SL



⊖	SL	1/4"	x5	ARC anty-slip
S2	HRC	58-60	DIN	3126

Folder	⊖	L	Box	Box
HT1S330	SL4	25 mm	10	100
HT1S331	SL5	25 mm	10	100
HT1S332	SL6	25 mm	10	100

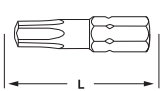
DE Schraubendreherspitzen torx SLIM EN Torx SLIM screwdriver bit FR Embout torx SLIM ES Punta de atornillar torx SLIM HR Bitovi odvijača torx SLIM HU Torx SLIM csavarhúzó bitfejek RO Biti surubelnita torx SLIM BG Бит накрайки torx SLIM







Folder	Symbol	L	Box	Box
HT1S361	T10	25 mm	10	100
HT1S362	T15	25 mm	10	100
HT1S363	T20	25 mm	10	100
HT1S364	T25	25 mm	10	100
HT1S366	T30	25 mm	10	100
HT1S367	T40	25 mm	10	100

TORX 1/4" x2 SLIM

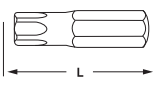
S2 HRC 58-60 DIN 3126

DE Schraubendreherspitzen torx EN Torx screwdriver bit FR Embout torx ES Punta de atornillar torx HR Bitovi odvijača torx HU Torx csavarhúzó bitfejek RO Biti surubelnita torx BG Бит накрайки torx







Folder	Symbol	L	Box	Box
HT1S334	T8	25 mm	10	100
HT1S335	T9	25 mm	10	100
HT1S336	T10	25 mm	10	100
HT1S337	T15	25 mm	10	100
HT1S338	T20	25 mm	10	100
HT1S339	T25	25 mm	10	100
HT1S340	T27	25 mm	10	100
HT1S341	T30	25 mm	10	100
HT1S342	T40	25 mm	10	100

TORX 1/4" x5 ARC anty-slip

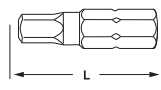
S2 HRC 58-60 DIN 3126

DE Schraubendreherspitzen hex SLIM EN Hex SLIM screwdriver bit FR Embout hex SLIM ES Punta de atornillar hex SLIM HR Bitovi odvijača hex SLIM HU Hex SLIM csavarhúzó bitfejek RO Biti surubelnita hex SLIM BG Бит накрайки hex SLIM







Folder	Symbol	L	Box	Box
HT1S343	H3	25 mm	10	100
HT1S344	H4	25 mm	10	100
HT1S345	H5	25 mm	10	100
HT1S346	H6	25 mm	10	100

HEX 1/4" x2 SLIM

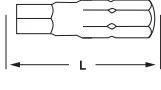
S2 HRC 58-60 DIN 3126

DE Schraubendreherspitzen hex EN Hex screwdriver bit FR Embout hex ES Punta de atornillar hex HR Bitovi odvijača hex HU Hex csavarhúzó bitfejek RO Biti surubelnita hex BG Бит накрайки hex







Folder	Symbol	L	Box	Box
HT1S347	H3	25 mm	10	100
HT1S348	H4	25 mm	10	100
HT1S349	H5	25 mm	10	100
HT1S350	H6	25 mm	10	100

HEX 1/4" x5 ARC anty-slip

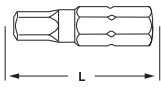
S2 HRC 58-60 DIN 3126

DE Schraubendreherspitzen hex SLIM EN Hex SLIM screwdriver bit FR Embout hex SLIM ES Punta de atornillar hex SLIM HR Bitovi odvijača hex SLIM HU Hex SLIM csavarhúzó bitfejek RO Biti surubelnita hex SLIM BG Бит накрайки hex SLIM







Folder	Symbol	L	Box	Box
HT1S359	H3, H4	25 mm	10	100

HEX 1/4" x2 SLIM

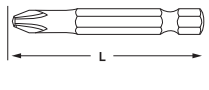
S2 HRC 58-60 DIN 3126

DE Schraubendreherspitzen PH EN PH screwdriver bit FR Embout PH ES Punta de atornillar PH HR Bitovi odvijača PH HU PH csavarhúzó bitfejek RO Biti surubelnita PH BG Бит накрайки PH







Folder	Symbol	L	Box	Box
HT1S323	PH0	50 mm	10	100
HT1S310	PH1	50 mm	10	100
HT1S311	PH2	50 mm	10	100
HT1S312	PH3	50 mm	10	100

PH 1/4" x2 ARC anty-slip

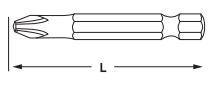
S2 HRC 58-60 DIN 3126

DE Schraubendreherspitzen PH EN PH screwdriver bit FR Embout PH ES Punta de atornillar PH HR Bitovi odvijača PH HU PH csavarhúzó bitfejek RO Biti surubelnita PH BG Битове накрайници PH







Folder	Symbol	L	Box	Box
HT1S392	PH2	50 mm	10	100

PH 1/4" x2 S2

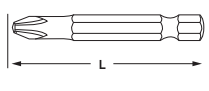
SLIM TiN COATED DIN 3126

DE Schraubendreherspitzen PH EN PH screwdriver bit FR Embout PH ES Punta de atornillar PH HR Bitovi odvijača PH HU PH csavarhúzó bitfejek RO Biti surubelnita PH BG Бит накрайки PH





Folder	Symbol	L	Box	Box
HT1S313	PH2	50 mm	10	100

PH 1/4" x5

S2 HRC 58-60 DIN 3126

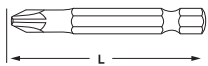
DE Schraubendreherspitzen PZ EN PZ screwdriver bit FR Embout PZ ES Punta de atornillar PZ HR Bitovi odvijajača PZ HU PZ csavarhúzó bitfejkek RO Biti surubelnita PZ BG Бит накрайки PZ



⊕ PZ	1/4"	x2	ARC anty-slip
S2	HRC 58-60	DIN 3126	

Folder	⊕	L	Box	Box
HT1S324	PZ0	50 mm	10	100
HT1S318	PZ1	50 mm	10	100
HT1S319	PZ2	50 mm	10	100
HT1S321	PZ3	50 mm	10	100

DE Schraubendreherspitzen PZ EN PZ screwdriver bit FR Embout PZ ES Punta de atornillar PZ HR Bitovi odvijajača PZ HU PZ csavarhúzó bitfejkek RO Biti surubelnita PZ BG Бит накрайки PZ

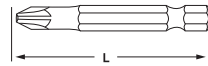

⊕ PZ	1/4"	x5	
S2	HRC 58-60	DIN 3126	

Folder	⊕	L	Box	Box
HT1S322	PZ2	50 mm	10	100

DE Schraubendreherspitzen PZ EN PZ screwdriver bit FR Embout PZ ES Punta de atornillar PZ HR Bitovi odvijajača PZ HU PZ csavarhúzó bitfejkek RO Biti surubelnita PZ BG Битове накрайници PZ

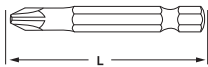

⊕ PZ	1/4"	x2	S2
SLIM	TiN COATED	DIN 3126	

Folder	⊕	L	Box	Box
HT1S395	PZ2	50 mm	10	100

DE Schraubendreher-Bit torx EN Torx screwdriver bit FR Embout torx ES Punta de atornillar torx HR Bit odvijajača torx HU Torx csavarhúzó bitfejkek RO Biti surubelnita torx BG Бит крайник torx



TORX	S2	HRC 58-60	
------	----	-----------	--

Folder	⊕	L	Box	Box
HT1S846	T20	75 mm	50	250
HT1S847	T25	75 mm	50	250
HT1S848	T27	75 mm	50	250
HT1S849	T30	75 mm	50	250
HT1S850	T40	75 mm	50	250
HT1S851	T45	75 mm	50	250
HT1S852	T50	75 mm	50	250
HT1S853	T55	75 mm	50	250

DE Schraubendreher-Bit spline EN SPLINE screwdriver bit FR Embout spline ES Punta de atornillar spline HR Bit odvijajača spline HU Spline csavarhúzó bit RO Biti surubelnita spline BG Бит крайник SPLINE



SPLINE	S2	HRC 58-60	
--------	----	-----------	--

Folder	⊕	L	Box	Box
HT1S885	M5	75 mm	50	250
HT1S886	M6	75 mm	50	250
HT1S888	M8	75 mm	50	250
HT1S890	M10	75 mm	50	250

DE Schraubendreher Schlag Bit PH EN PH screwdriver impact bit FR Ensemble de bits de tournevis PH ES Puntas Para Destornilladores PH HR Bitovi set PH HU PH bit készlet RO Set varfuri PH BG Бит крайник ударен PH

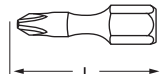

⊕ PH	1/4"	x5	S2
HRC 58-61	DIN 3126		

Folder	⊕	L	Box	Box
HT1S120	PH0	25 mm	10	100
HT1S121	PH1	25 mm	10	100
HT1S122	PH2	25 mm	10	100
HT1S123	PH3	25 mm	10	100

DE Schraubendreher Schlag Bit PZ EN PZ screwdriver impact bit FR Ensemble de bits de tournevis PZ ES Puntas Para Destornilladores PZ HR Bitovi set PZ HU PZ bit készlet RO Set varfuri PZ BG Бит крайник ударен PZ

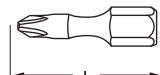

⊕ PZ	1/4"	x5	S2
HRC 58-61	DIN 3126		

Folder	⊕	L	Box	Box
HT1S125	PZ0	25 mm	10	100
HT1S126	PZ1	25 mm	10	100
HT1S127	PZ2	25 mm	10	100
HT1S128	PZ3	25 mm	10	100

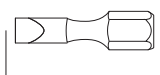

DE Schraubendreher Schlag Bit SL EN SL screwdriver impact bit FR Ensemble de bits de tournevis SL ES Puntas Para Destornilladores SL HR Bitovi set SL HU SL bit készlet RO Set varfuri SL BG Бит крайник ударен SL



⊖ SL	1/4"	x5	S2
HRC 58-61	DIN 3126		

Folder	⊖	L	Box	Box
HT1S130	SL4	25 mm	10	100
HT1S131	SL5	25 mm	10	100
HT1S132	SL6	25 mm	10	100

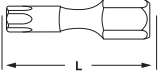
DE Schraubendreher Schlag Bit torx security EN Torx security screwdriver impact bit FR Ensemble de bits de tournevis torx security ES Puntas Para Destornilladores torx security HR Bitovi set torx security HU Torx security Bit készlet RO Set varfuri torx security BG Бит крайник ударен torx security







Folder	Symbol	L	Box	Box
HT1S135	TT10	25 mm	10	100
HT1S136	TT15	25 mm	10	100
HT1S137	TT20	25 mm	10	100
HT1S138	TT25	25 mm	10	100
HT1S139	TT27	25 mm	10	100
HT1S140	TT30	25 mm	10	100
HT1S141	TT35	25 mm	10	100
HT1S142	TT40	25 mm	10	100

TAMPER TORX 1/4" x5 S2

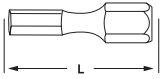
HRC 58-61 DIN 3126

DE Schraubendreher Schlag Bit hex EN Hex screwdriver impact bit FR Ensemble de bits de tournevis hex ES Puntas Para Destornilladores hex HR Bitovi set hex HU Hex bit készlet RO Set varfuri hex BG Бит крайник ударен hex







Folder	Symbol	L	Box	Box
HT1S145	H3	25 mm	10	100
HT1S146	H4	25 mm	10	100
HT1S147	H5	25 mm	10	100
HT1S148	H6	25 mm	10	100

HEX 1/4" x5 S2

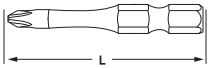
HRC 58-61 DIN 3126

DE Schraubendreher Schlag Bit PH EN PH screwdriver impact bit FR Ensemble de bits de tournevis PH ES Puntas Para Destornilladores PH HR Bitovi set PH HU PH bit készlet RO Set varfuri PH BG Бит крайник ударен PH







Folder	Symbol	L	Box	Box
HT1S150	PH0	50 mm	10	100
HT1S151	PH1	50 mm	10	100
HT1S152	PH2	50 mm	10	100
HT1S153	PH3	50 mm	10	100

PH 1/4" x2 S2

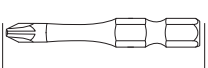
HRC 58-61 DIN 3126

DE Schraubendreher Schlag Bit PZ EN PZ screwdriver impact bit FR Ensemble de bits de tournevis PZ ES Puntas Para Destornilladores PZ HR Bitovi set PZ HU PZ bit készlet RO Set varfuri PZ BG Бит крайник ударен PZ







Folder	Symbol	L	Box	Box
HT1S155	PZ0	50 mm	10	100
HT1S156	PZ1	50 mm	10	100
HT1S157	PZ2	50 mm	10	100
HT1S158	PZ3	50 mm	10	100

PZ 1/4" x2 S2

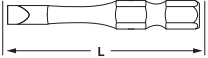
HRC 58-61 DIN 3126

DE Schraubendreher Schlag Bit SL EN SL screwdriver impact bit FR Ensemble de bits de tournevis SL ES Puntas Para Destornilladores SL HR Bitovi set SL HU SL bit készlet RO Set varfuri SL BG Бит крайник ударен SL







Folder	Symbol	L	Box	Box
HT1S160	SL4	50 mm	10	100
HT1S161	SL5	50 mm	10	100
HT1S162	SL6	50 mm	10	100

SL 1/4" x2 S2

HRC 58-61 DIN 3126

DE Schraubendreher Schlag Bit torx security EN Torx security screwdriver impact bit FR Ensemble de bits de tournevis torx security ES Puntas Para Destornilladores torx security HR Bitovi set torx security HU Torx security Bit készlet RO Set varfuri torx security BG Бит крайник ударен torx security







Folder	Symbol	L	Box	Box
HT1S165	TT10	50 mm	10	100
HT1S166	TT15	50 mm	10	100
HT1S167	TT20	50 mm	10	100
HT1S168	TT25	50 mm	10	100
HT1S169	TT27	50 mm	10	100
HT1S170	TT30	50 mm	10	100
HT1S171	TT35	50 mm	10	100
HT1S172	TT40	50 mm	10	100

TAMPER TORX 1/4" x2 S2

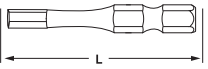
HRC 58-61 DIN 3126

DE Schraubendreher Schlag Bit hex EN Hex screwdriver impact bit FR Ensemble de bits de tournevis hex ES Puntas Para Destornilladores hex HR Bitovi set hex HU Hex bit készlet RO Set varfuri hex BG Бит крайник ударен hex

Folder	Symbol	L	Box	Box
HT1S175	H3	50 mm	10	100
HT1S176	H4	50 mm	10	100
HT1S177	H5	50 mm	10	100
HT1S178	H6	50 mm	10	100

HEX 1/4" x2 S2

HRC 58-61 DIN 3126

DE Sechskantschlüsselsatz kurz EN Hex key set FR Jeu de clés hexagonales ES Juego de llaves Allen HR Šesterokutni ključevi HU Hex kulcsok RO Chei hex BG Имбусни ключове къси





1,5; 2; 2,5; 3; 4; 5; 6; 8; 10

Folder	Symbol	L	Box	Box
HT1W802	1,5-10 mm	12	72	

x9 HEX CrV DIN ISO 911 SHORT

DE Sechskantschlüsselsatz lang EN Hex key set, long arm FR Jeu de clés hexagonales ES Juego de llaves Allen HR Šesterokutni ključevi HU Hex kulcsok RO Chei hex BG Имбусни ключове удължени



○
1,5; 2; 2,5; 3; 4;
5; 6; 8; 10 mm

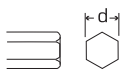

x9	HEX	CrV	LONG	DIN ISO 911	HT1W801	1,5-10 mm	12	48
----	-----	-----	------	-------------	---------	-----------	----	----

DE Sechskantschlüsselsatz extra lang EN Hex key set, extra long arm FR Jeu de clés hexagonales ES Juego de llaves Allen HR Šesterokutni ključevi HU Hex kulcsok RO Chei hex BG Имбусни ключове много дълги



○
1,5; 2; 2,5; 3; 4;
5; 6; 8; 10 mm

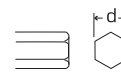

x9	HEX	CrV	EXTRA LONG	DIN ISO 911	HT1W803	1,5-10 mm	10	40
----	-----	-----	------------	-------------	---------	-----------	----	----

DE Sechskantschlüsselsatz für präzise Arbeiten EN Precision hex key set FR Jeu Clés hexagonales de précision ES Juego de llaves Allen de precisión HR Šesterokutni ključevi, precizni HU Precíziós hex kulcskészlet RO Set de chei hex de precizie BG Имбусни ключове точни

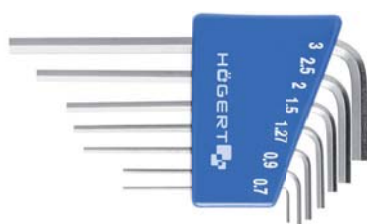

○
0,6; 0,9; 1,17; 1,5;
2; 2,5; 3 mm

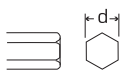

x7	HEX	CrV			HT1W800	0,71-3,0 mm	12	144
----	-----	-----	--	--	---------	-------------	----	-----

DE Sechskantschlüsselsatz, lange EN Hex key set, long arm FR Jeu de clés hexagonales extra-longues ES Juego de llaves Allen de brazo largo HR Šesterokutni ključevi, dugi, dijagonalni HU Hex kulcsok, hosszú, átlós RO Chei lungi hex, transversal BG Имбусни ключове дълги



○
1,5; 2; 2,5; 3; 4; 5;
6; 8; 10 mm

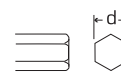

x9	HEX	CrV	EXTRA LONG		HT1W807	1,5-10 mm	6	24
----	-----	-----	------------	--	---------	-----------	---	----

DE Sechskantschlüsselsatz mit Kugelkopf EN Pall-end hex key set, long arm FR Jeu de clés hexagonales à tête sphérique ES Juego de llaves Allen con punta bola, acero HR Šesterokutni ključevi HU Hex kulcsok RO Chei hex BG Имбусни удължени ключове със сферична глава, дълги



○
1,5; 2; 2,5; 3; 4; 5;
6; 8; 10 mm

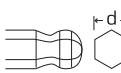

x9	HEX	CrV	LONG		HT1W804	1,5-10 mm	12	48
----	-----	-----	------	--	---------	-----------	----	----

DE Sechskantschlüssel, lange EN Pall-end hex key set, extra long arm FR Jeu de clés hexagonales extra-longues ES Juego de llaves Allen de brazo largo HR Šesterokutni ključevi HU Hex kulcsok RO Chei hex BG Имбусни удължени ключове със сферична глава, много дълги



○
1,5; 2; 2,5; 3; 4;
5; 6; 8; 10 mm

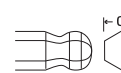

x9	HEX	CrV	EXTRA LONG		HT1W808	1,5-10 mm	10	40
----	-----	-----	------------	--	---------	-----------	----	----

DE Torx-Schlüsselsatz EN Torx key set, long arm FR Jeu de clés torx ES Juego de llaves torx HR Torx ključevi HU Torx kulcsok RO Chei torx BG Имбусни ключове torx дълги



●
T10, T15, T20, T25, T27,
T30, T40, T45, T50

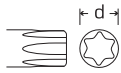

x9	TORX	CrV	LONG		HT1W814	T10-T50	12	48
----	------	-----	------	--	---------	---------	----	----

DE Torx-Schlüsselsatz, lang EN Torx key set, extra long arm FR Jeu de clés Torx colorés ES Juego de llaves Torx de brazo largo HR Torx ključevi HU Torx kulcsok RO Chei torx BG Имбусни ключове torx много дълги



●
T10, T15, T20, T25, T27,
T30, T40, T45, T50

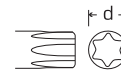

x9	TORX	CrV	EXTRA LONG		HT1W818	T10-T50	10	40
----	------	-----	------------	--	---------	---------	----	----

DE Torx security-Schlüsselsatz EN Torx security key set, long arm FR Jeu de clés torx security ES Juego de llaves torx security HR Torx security ključevi HU Torx security kulcsok RO Chei torx security BG Имбусни ключове torx security, дълги

DE Torx security-Schlüsselsatz EN Tamper torx key set, extra long arm FR Jeu de clés torx security ES Juego de llaves torx security HR Torx security ključevi HU Torx security kulcsok RO Chei torx security BG Имбусни ключове torx security, много дълги



⊕
TT10, TT15, TT20, TT25,
TT27, TT30, TT40, TT45,
TT50

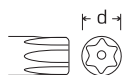

⊕
TT10, TT15, TT20, TT25,
TT27, TT30, TT40, TT45,
TT50

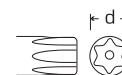

x9 TAMPER TORX CrV LONG

HT1W809	TT10-TT50	6	48

x9 TAMPER TORX CrV EXTRA LONG

HT1W810	TT10-TT50	6	340

DE Sechskantschlüsselsatz kurz EN Hex key set FR Jeu de clés hexagonales ES Juego de llaves Allen HR Šesterokutni ključevi HU Hex kulcsok RO Chei hex BG Имбусни ключове къси

DE Sechskantschlüsselsatz lang EN Hex key set, long arm FR Jeu de clés hexagonales ES Juego de llaves Allen HR Šesterokutni ključevi HU Hex kulcsok RO Chei hex BG Имбусни ключове удължени



○
1,5; 2; 2,5; 3; 4; 5; 6; 8; 10 mm

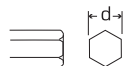

○
1,5; 2; 2,5; 3; 4; 5; 6;
8; 10 mm



x9 HEX S2 SHORT

HT1W820	1,5-10 mm	6	520

x9 HEX S2 LONG

HT1W821	1,5-10 mm	6	500

DE Sechskantschlüsselsatz extra lang EN Hex key set, extra long arm FR Jeu de clés hexagonales ES Juego de llaves Allen HR Šesterokutni ključevi HU Hex kulcsok RO Chei hex BG Имбусни ключове много дълги

DE Sechskantschlüssel mit Kugel, lang EN Pall-end hex key set, long arm FR Clés hexagonales à bille, longues ES llaves hexagonales con bola, largas HR Ključevi šesterokutni s kuglicom, dugi HU Hatszögletű golyós kulcs, hosszú RO Chei hexagonale cu bilă, lungi BG Имбусни удължени ключове със сферична глава, дълги



○
1,5; 2; 2,5; 3; 4; 5; 6;
8; 10 mm

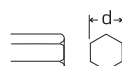

○
1,5; 2; 2,5; 3; 4; 5; 6;
8; 10 mm



x9 HEX S2 EXTRA LONG

HT1W822	1,5-10 mm	6	340

x9 HEX S2 LONG

HT1W825	1,5-10 mm	5	600

DE Sechskantschlüssel mit Kugel, extra lang EN Pall-end hex key set, extra long arm FR Clés hexagonales à boule, ultra longues ES llaves hexagonales con bola, extra largas HR Ključevi šesterokutni s kuglicom, ekstra dugi HU Hatszögletű kulcsok golyós, extra hosszú RO Chei hexagonale cu bilă, foarte lungi BG Имбусни удължени ключове със сферична глава, много дълги

DE Sicherheits-Torx-Schlüssel, lang EN Tamper torx key set FR Clés torx de sécurité, longues ES Llaves torx de seguridad, largas HR Torx sigurnosni ključevi, dugi HU Torx security kulcs, hosszú RO Chei torx security, lungi BG Имбусни ключове torx security, дълги



○
1,5; 2; 2,5; 3; 4; 5; 6;
8; 10 mm



⊕
TT10, TT15, TT20,
TT25, TT27, TT30,
TT40, TT45, TT50



x9 HEX S2 EXTRA LONG

HT1W826	1,5-10 mm	6	340

x9 TAMPER TORX S2 LONG

HT1W830	TT10-TT50	6	500

DE Sicherheits-Torx-Schlüssel, extra lang EN Tamper torx key set, long arm FR Clés torx de sécurité, ultra longues ES Llaves torx de seguridad, extra largas HR Torx sigurnosni ključevi, ekstra dugi HU Torx security kulcs, extra hosszú RO Chei torx security, extra lungi BG Имбусни ключове torx security, много дълги

DE Torx-Schlüsselsatz, lang EN Torx key set, long arm FR Jeu de clés Torx ES Juego de llaves torx HR Torx ključevi HU Torx kulcsok RO Chei torx BG Имбусни ключове torx дълги



⊕
TT10, TT15, TT20,
TT25, TT27, TT30,
TT40, TT45, TT50

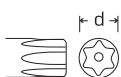

⊕
T10, T15, T20, T25, T27,
T30, T40, T45, T50

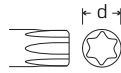

x9	TAMPER TORX	S2	EXTRA LONG	HT1W831	TT10-TT50	6	340
----	-------------	----	------------	---------	-----------	---	-----

x9	TORX	S2	LONG	HT1W816	T10-T50	10	40
----	------	----	------	---------	---------	----	----

DE Sechskantschlüsselsatz, lang EN Hex key set FR Jeu de clés hexagonales colorées à tête sphérique ES Juego de llaves Allen de brazo largo HR Šesterokutni ključevi, kodirani bojom HU Hex kulcsok, színkódos RO Chei hex, cu cod de culoare BG Имбусни ключове

DE Torx-Schlüsselsatz, lang, Multicolour EN Torx key set FR Jeu de clés torx colorés ES Juego de llaves Torx de brazo largo HR Torx ključevi, kodirani bojom HU Torx kulcsok, színkódos RO Chei torx, cu cod de culoare BG Имбусни ключове torx



⊙
1,5; 2; 2,5; 3; 4;
5; 6; 8; 10 mm

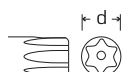
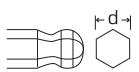

⊙
TT10, TT15, TT20, TT25,
TT27, TT30, TT40, TT45, TT50



x9	HEX	LONG	S2	DIN ISO 911	HT1W806	1,5-10 mm	6	48
----	-----	------	----	-------------	---------	-----------	---	----

x9	TORX	S2	LONG	HT1W817	T10-T50	6	48
----	------	----	------	---------	---------	---	----

DE Präzisions-Schraubendreher-Satz EN Precision screwdriver set FR Coffret de tournevis de précision ES Caja destornilladores de precisión HR Set odvijača, precizni HU Precision Screwdriver Set RO Set de surubelnite de precizie BG Комплект прецизни отвертки

DE Präzisions-Schraubendreher-Satz EN Precision screwdriver set FR Coffret de tournevis de précision ES Caja destornilladores de precisión HR Komplet preciznih odvijača HU Precision screwdriver set RO Set de surubelnite de precizie BG Комплект прецизни отвертки



⊖ 0.5 x 3.0 x 25 mm
⊖ 0.4 x 2.5 x 25 mm
⊖ 0.4 x 2.0 x 25 mm
⊖ 0.3 x 1.6 x 25 mm
⊕ 0 x 3.0 x 25 mm
⊕ 00 x 2.5 x 25 mm



⊖ 1,5 x 50 mm
⊖ 2 x 50 mm
⊕ PH00 - 50 mm
⊕ PH0 - 50 mm
⊕ T5 - 50 mm
⊕ T6 - 50 mm
⊕ T7 - 50 mm



x6	CrV	MAGNETIC	ERGO GRIP	HT1S272	12	72
----	-----	----------	-----------	---------	----	----

x7	MAGNETIC	ERGO GRIP	HT1S270	6	36
----	----------	-----------	---------	---	----

DE Präzisions-Schraubendreher-Satz EN Precision screwdriver set FR Coffret de tournevis de précision ES Caja destornilladores de precisión HR Komplet preciznih odvijača za pametne telefone i prenosna računala HU Precíziós csavarhúzó készlet okostelefonokhoz és laptopokhoz RO Set de surubelnite de precizie, pentru smartphone-uri si laptopuri BG Комплект прецизни отвертки

DE Schraubendreher EN Screwdriver set FR Jeu de Tournevis ES Juego de destornilladores HR Komplet odvijača HU Csavarhúzó készlet RO Set de surubelnite BG Комплект отвертки



⊖ 1,2 mm
⊖ 2,0 mm
⊕ 0,8 / 2,0 mm
⊕ PH00 / PH000
⊕ T4 / T5 / T6 / T7 / T8 / T10



⊖ 3 x 75 mm
⊖ 5 x 100 mm
⊕ PH1 - 75 mm
⊕ PH2 - 100 mm



x17	CrV	MAGNETIC	ERGO GRIP	HT1S271	6	24
-----	-----	----------	-----------	---------	---	----

x4	S2	MAGNETIC	ERGO GRIP	HT1S094	6	24
----	----	----------	-----------	---------	---	----

DE Schraubendreher eingestellt EN Screwdriver set FR Jeu de Tournevis ES Juego de destornilladores HR Komplet odvijača HU Csavarhúzó készlet RO Set de surubelnite BG Комплект отвертки



- ⊖ 6 x 100 mm
- ⊖ 5 x 75 mm
- ⊖ 3 x 75 mm
- ⊕ PH2 x 100 mm
- ⊕ PH1 x 75
- ⊕ PH0 x 75



x6	S2	MAGNETIC	ERGO GRIP
----	----	----------	-----------

HT1S095	6	36

DE Schraubendreher eingestellt EN Screwdriver set FR Jeu de Tournevis ES Juego de destornilladores HR Komplet odvijača HU Csavarhúzó készlet RO Set de surubelnite BG Комплект отвертки



- ⊖ 6 x 150 mm
- ⊖ 5 x 75 mm
- ⊖ 3 x 75 mm
- ⊖ 6 x 38 mm
- ⊕ PH2 x 150 mm
- ⊕ PH1 x 75
- ⊕ PH0 x 75
- ⊕ PH2 x 38



x8	S2	MAGNETIC	ERGO GRIP
----	----	----------	-----------

HT1S096	6	24

DE Schraubendreher eingestellt EN Screwdriver set FR Jeu de Tournevis ES Juego de destornilladores HR Set odvijača HU Csavarhúzó készlet RO Set de surubelnite BG Комплект отвертки



- ⊖ 6 x 125 mm, 5 x 100 mm, 3 x 75 mm, 6 x 38 mm
- ⊕ PH2 x 125 mm, PH1 x 100 mm, PH0 x 75 mm, PH2 x 38 mm
- ⊖ 2,0 x 40 mm, 2,5 x 40 mm
- ⊕ PH0 x 40 mm, PH00 x 40 mm



x12	S2	CrV	MAGNETIC	ERGO GRIP
-----	----	-----	----------	-----------

HT1S097	6	12

DE Schraubendreher EN Screwdriver set FR Jeu de Tournevis ES Juego de destornilladores HR Komplet odvijača HU Csavarhúzó készlet RO Set de surubelnite BG Комплект отвертки



- ⊖ 6 x 38 mm, 5 x 75 mm, 6 x 100 mm, 8 x 150 mm
- ⊕ PH1 x 75 mm, PH2 x 38 mm, PH2 x 100 mm, PH3 x 150 mm
- ⊖ 2,5 x 40 mm, 3,0 x 40 mm
- ⊕ PH00 x 40 mm, PH0 x 40 mm
- ⊙ T5 x 40 mm, T6 x 40 mm, T7 x 40 mm, T8 x 40 mm, T9 x 40 mm, T10 x 40 mm



x18	S2	MAGNETIC	ERGO GRIP
-----	----	----------	-----------

HT1S098	6	24

DE Schraubendreher eingestellt EN Screwdriver with accessories FR Jeu de Tournevis ES Juego de destornilladores HR Set odvijača HU Csavarhúzó készlet RO Set de surubelnite BG Комплект отвертки с аксесоари



- ⊖ SL 3 mm, 4 mm, 5 mm, 6 mm
- ⊕ PH0, PH1, PH2, PH2, PH3
- ⊕ PZ0, PZ1, PZ2, PZ2, PZ3
- ⊙ T10, T15, T20, T25
- ⊙ TT10, TT15, TT20, TT25
- ⊙ H3, H4, H5, H6
- 1/4" socket adapter
- 1/4" sockets: 4 mm, 5 mm, 6 mm, 7 mm, 8 mm, 9 mm

x34	S2	CrV	MAGNETIC	ERGO GRIP
-----	----	-----	----------	-----------

HT1S100	6	24

DE Schraubendreher eingestellt EN Screwdriver with accessories FR Jeu de Tournevis ES Juego de destornilladores HR Set odvijača HU Csavarhúzó készlet RO Set de surubelnite BG Комплект отвертки с аксесоари



- ⊖ SL 3 mm, 4 mm, 5 mm, 6 mm, 7 mm
- ⊕ PH0, PH1, PH2, PH3
- ⊕ PZ0, PZ1, PZ2, PZ3
- ⊙ T10, T15, T20, T25
- ⊙ TT10, TT15, TT20, TT25
- ⊙ H3, H4, H5, H6
- 1/4" socket adapter
- 1/4" sockets: 4 mm, 5 mm, 6 mm, 7 mm, 8 mm, 9 mm, 10 mm, 11 mm, 12 mm

x36	S2	CrV	MAGNETIC	RATCHED HANDLE	ERGO GRIP
-----	----	-----	----------	----------------	-----------

HT1S101	6	24

DE Schraubendreher Set EN Screwdriver with 1:5 gear and accessories FR Jeu de tournevis ES Juego de destornilladores HR Odvijač s nastavcima HU Csavarhúzó készlet RO Set de surubelnite BG Отвертка с бит държач тресчотна 1:5 с аксесоари



- ⊖ 3 mm, 4 mm, 5 mm, 6 mm
- ⊕ PH0, PH1, PH2, PH3
- ⊙ T10, T15, T20, T25



x13	360° 1:5	S2	MAGNETIC	ERGO GRIP
-----	----------	----	----------	-----------

HT1S215	6	36

DE Schraubendreher Set EN Screwdriver with 1:5 gear and accessories FR Jeu de tournevis ES Juego de destornilladores HR Odvijač s nastavcima HU Csavarhúzó készlet RO Set de surubelnite BG Отвертка с бит държач тресчотна 1:5 и чупеца дръжка с аксесоари



- ⊖ 3 mm, 4 mm, 5 mm, 6 mm
- ⊕ PH0, PH1, PH2, PH3
- ⊙ T10, T15, T20, T25



x13	360° 1:5	S2	MAGNETIC	RATCHED HANDLE	ERGO GRIP
-----	----------	----	----------	----------------	-----------

HT1S216	6	36

DE Schraubendreher eingestellt EN Screwdrivers set FR Jeu de Tournevis ES Juego de destornilladores HR Set odvijača HU Csavarhúzó készlet RO Set de surubelnite BG Комплект отвертки



- ⊖ 6 x 125 mm, 5 x 100 mm, 3 x 75 mm
- ⊕ PH2 x 125 mm, PH2 x 100 mm, PH1 x 100 mm, PH0 x 75 mm
- Precision screwdrivers:
 - ⊖ 2.0 x 50 mm, 2.5 x 50 mm
 - ⊙ T6 x 50 mm, T8 x 50 mm
 - ⊕ PH00 x 50 mm, PH000 x 50 mm
 - 1/4" socket adapter
 - Magnetizer
 - Magnetic handle
 - 1/4" bit handle
 - Off-set key:
 - PH2 x SL 6 mm, PH1 x SL 5 mm
 - 1/4" screwdriver bits:
 - ⊖ SL 3 mm, 2 x 4 mm, 2 x 5 mm, 2 x 6 mm
 - ⊕ PH0, 2 x PH1, 2 x PH2, 2 x PH3
 - ⊕ PZ0, 2 x PZ1, 2 x PZ2, PZ3
 - ⊙ T10, T15, T20, T25, T27, T30, T35
 - ⊙ H3, H4, H5, H6
 - S0, S1, S2, S3
 - 1/4" sockets:
 - 4 mm, 5 mm, 6 mm, 7 mm, 8 mm, 9 mm, 10 mm, 11 mm, 12 mm

x64	S2	CrV	MAGNETIC	ERGO GRIP
-----	----	-----	----------	-----------

HT1S105	6	12

DE Schraubendreher eingestellt EN Screwdrivers set FR Jeu de Tournevis ES Juego de destornilladores HR Set odvijača i bitova HU Csavarhúzó és bitfej készlet RO Set de surubelnite si biti BG Комплект отвертки



- 16 screwdrivers
 - ⊖ Flat screwdrivers: 3 x 75 mm, 5 x 75 mm, 5 x 100 mm, 6 x 100 mm, 6 x 150 mm, 8 x 150 mm
 - ⊕ Cross screwdrivers: PH0 x 75 mm, PH1 x 75 mm, PH1 x 100 mm, PH2 x 100 mm, PH2 x 150 mm
 - ⊙ Torx screwdrivers: T10 x 75 mm, T15 x 75 mm, T20 x 75 mm
 - ⊙ Square screwdrivers: S1 x 75 mm, S2 x 100 mm
- Screwdriver bits on socket 1" (48 pieces)
 - 3 mm, 3 mm, 4 mm, 4 mm, 5 mm, 5 mm, 6 mm, 6 mm
 - ⊕ PH0, PH0, PH1, PH1, PH2, PH2, PH3, PH3
 - ⊙ T10, T10, T15, T15, T20, T20, T20, T25, T25, T25, T27, T27, T30, T30
 - ⊙ H3, H3, H4, H4, H5, H5, H5, H6, H6, H6
 - S0, S0, S1, S1, S2, S2, S3, S3
- Hexagonal screwdrivers (16 pieces)
 - 1,5 mm, 2,0 mm, 2,5 mm, 3,0 mm, 4,0 mm, 5,0 mm, 5,5 mm, 6,0 mm
 - 1/16", 5/64", 3/32", 1/8", 5/32", 3/16", 7/32", 1/4"
- Precision screwdriver bits (20 pieces)
 - PH000, PH000, Y000, Y000
 - 0,8 mm, 0,8 mm, 1,2 mm, and 1,2 mm
 - T4, T4, T5, T5, T6, T6
 - 1,0 mm, 1,0 mm, 1,5 mm, 1,5 mm, 2,0 mm, 2,0 mm
- Nut Drivers (6 pieces)
 - 6 mm, 7 mm, 8 mm, 9 mm, 10 mm, 11 mm
- Precision screwdrivers (6 pieces)
 - 2,0 x 40 mm, 2,5 x 40 mm, 3,0x40 mm, PH00 x 40 mm, PH0 x 40 mm, T10 x 40 mm
- Bit adapter
- Precision bit adapter
- Socket adapter



x114	S2	CrV	MAGNETIC	ERGO GRIP
------	----	-----	----------	-----------

HT1S099	3	6



DE Steckschlüssel-Schraubendreher EN Screwdriver bit holder FR Tournevis porte-embout ES Destornillador Portapuntas HR Ručka za bitove odvijača HU Csavarhúzó bitfej adapter RO Maner biti tip surubelnita BG Отвертка с бит държач



1/4" CrV ERGO GRIP

Folder	Shaft Dia	Shaft Length	Box Qty	Box Qty
HT1S201	1/4"	100 mm	12	144

DE Schlitz-Schraubendreher EN Slotted screwdriver FR Tournevis plat ES Destornillador de punta plana HR Ravni odvijači HU Lapos csavarhúzó RO Surubelnite dreapte BG Отвертка права SL

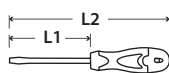

Folder	Shaft Dia	L1	L2	Box Qty	Box Qty
HT1S001	3	75 mm	163 mm	12	360
HT1S002	3	100 mm	188 mm	12	360
HT1S004	4	100 mm	188 mm	12	360
HT1S008	5	100 mm	198 mm	12	240
HT1S010	6,5	38 mm	104 mm	12	360
HT1S012	6	100 mm	208 mm	12	144
HT1S014	6	150 mm	258 mm	12	144
HT1S015	6,5	200 mm	308 mm	12	144

SL S2 MAGNETIC ERGO GRIP

DE Kreuzschlitzschraubendreher PH EN PH screwdriver FR Tournevis ES Destornillador PH HR Križni odvijači PH HU PH csavarhúzó RO Surubelnite PH BG Отвертка PH

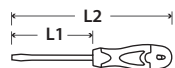

Folder	Shaft Dia	L1	L2	Box Qty	Box Qty
HT1S020	PH0	75 mm	163 mm	12	360
HT1S023	PH1	75 mm	173 mm	12	240
HT1S024	PH1	100 mm	198 mm	12	240
HT1S028	PH2	38 mm	104 mm	12	360
HT1S029	PH2	100 mm	208 mm	12	144
HT1S032	PH2	200 mm	308 mm	12	144

PH S2 MAGNETIC ERGO GRIP

DE Kreuzschlitzschraubendreher PZ EN PZ screwdriver FR Tournevis Pozidriv ES Destornillador Pozidriv PZ HR Križni odvijači PZ HU PZ csavarhúzó RO Surubelnite PZ BG Отвертка PZ

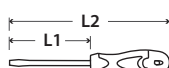

Folder	Shaft Dia	L1	L2	Box Qty	Box Qty
HT1S040	PZ0	75 mm	163	12	360
HT1S041	PZ1	100 mm	173	12	240
HT1S042	PZ2	100 mm	208	12	144

PZ S2 MAGNETIC ERGO GRIP

DE Schraubendreher torx EN Torx Screwdriver FR Tournevis torx ES Destornillador torx HR Odvijači torx HU Torx csavarhúzó RO Surubelnite torx BG Отвертка torx

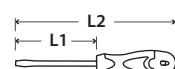

Folder	Shaft Dia	L1	L2	Box Qty	Box Qty
HT1S051	T8	75 mm	163 mm	12	240
HT1S053	T9	100 mm	198 mm	12	240
HT1S054	T15	100 mm	198 mm	12	240
HT1S055	T20	100 mm	198 mm	12	240
HT1S056	T25	100 mm	208 mm	12	144
HT1S057	T27	100 mm	208 mm	12	144
HT1S058	T30	100 mm	208 mm	12	144
HT1S059	T40	150 mm	268 mm	6	96

TORX S2 MAGNETIC ERGO GRIP

DE Schraubendreher mit Schlagkappe EN Demolition SL screwdriver FR Tournevis plat à frapper ES Destornillador de impacto HR Ravni odvijači za udaranje HU Lapos bontó csavarhúzó RO Surubelnite drepte pentru demolare BG Отвертка SL задвижване

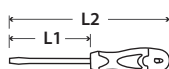

Folder	Shaft Dia	L1	L2	Box Qty	Box Qty
HT1S064	5,5	100 mm	200 mm	12	144
HT1S066	6	125 mm	233 mm	12	144
HT1S068	8	150 mm	266 mm	6	96

IMPACT CORE EXTRA TORQUE CrV MAGNETIC ERGO GRIP

DE Schraubendreher mit Schlagkappe EN Demolition PH screwdriver FR Tournevis à frapper ES Destornillador de impacto HR Križni odvijač za udaranje HU Bontó csavarhúzó RO Surubelnite pentru demolare BG Отвертка PH задвижване

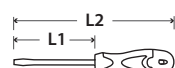

Folder	Shaft Dia	L1	L2	Box Qty	Box Qty
HT1S072	PH2	125 mm	233 mm	12	144

IMPACT CORE EXTRA TORQUE CrV MAGNETIC ERGO GRIP

DE Schlagschrauber EN Impact screwdriver FR Tournevis à percussion ES Destornillador de impacto HR Udarni odvijač HU Útés csavarhúzó RO Şurubelniţă de impact BG Ударна отвертка



- 1/2" - 12.7 mm
- 5/16" - 7.9 mm
- ⌀ 6 x 36 mm
- ⌀ 8 x 36 mm
- ⌀ 8 x 78 mm
- ⊕ PH2 x 36 mm
- ⊕ PH3 x 36 mm
- ⊕ PH3 x 78 mm



CrV 1/2" 12.7 mm 5/16" 7.9 mm

Folder	Box Qty	Box Qty
HT1S077	1	20

DE Bit-Schraubendreher, kurze Ausführung mit Ratsche **EN** Ratcheting multi-bit screwdriver **FR** Tournevis multi-embouts à cliquet **ES** Destornillador multipuntas de carraca **HR** Odvijač sa zamenljivim bitovima **HU** Multi-bitfej csavarhúzó **RO** Surubelnita multi-bit **BG** Отвертка с тресчотка и битове



- 3 mm, 6 mm
- ⊕ PH1
- ⊕ PH2
- ⊕ PH3
- ⊙ T15
- ⊙ T20
- ⊙ H4



x9	length 10cm	S2	MAGNETIC	ERGO GRIP			
					HT1S214	10	100

DE Präzisions-Schraubendreher-Satz **EN** Insulated 1000 V precision screwdriver set **FR** Jeu de tournevis de précision isolé 1000 V **ES** Pack de destornilladores de precisión 1000 V **HR** Komplet preciznih odvijača 1000 V **HU** Precíziós szigetelt csavarhúzó készlet 1000 V **RO** Set de surubelnite izolate de precizie 1000 V **BG** Комплект отверки прецизни VDE 1000 V



- ⊖ 1,5 x 50 mm
- ⊖ 2,0 x 50 mm
- ⊖ 3,0 x 50 mm
- ⊕ PH00 - 50 mm
- ⊕ PH0 - 50 mm
- ⊕ PH1 - 50 mm

x6	VDE 1000V	CrMo	MAGNETIC	ERGO GRIP			
					HT1S986	12	72

DE Schraubendreher-Satz 1000 V **EN** Insulated 1000 V screwdriver set **FR** Pack de tournevis isolés 1000 V **ES** Pack de destornilladores aislados 1000 V **HR** Komplet odvijača 1000 V **HU** Lapos csavarhúzó készlet **RO** Set de surubelnite izolate drepte **BG** Комплект отверки 1000 V

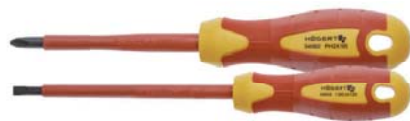

- ⊖ 5,5
- ⊕ PH2

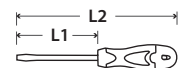

x2	VDE 1000V	⊖ SL	⊕ PH				
				S2	MAGNETIC	ERGO GRIP	

	L1	L2		
HT1S990	125 mm	223 mm	12	72
	100 mm	210 mm		

DE Schraubendreher-Satz 1000 V **EN** Insulated 1000 V screwdriver set **FR** Pack de tournevis isolés 1000 V **ES** Pack de destornilladores aislados 1000 V **HR** Komplet odvijača 1000 V **HU** Lapos csavarhúzó készlet **RO** Set de surubelnite izolate drepte **BG** Комплект отверки 1000 V

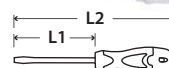

x5	VDE 1000V	100-250V	S2				
				MAGNETIC	ERGO GRIP	EN 60900	

	⊖	L1	L2		
HT1S994	⊖ 3,5	100 mm	188 mm	6	24
	⊖ 5,5	125 mm	223 mm		
	⊕ PH1	80 mm	178 mm		
	⊕ PH2	100 mm	210 mm		
	Voltage tester				

DE Schraubendreher-Satz 1000 V **EN** Insulated 1000 V screwdriver set **FR** Pack de tournevis isolés 1000 V **ES** Pack de destornilladores aislados 1000 V **HR** Komplet odvijača 1000 V **HU** Lapos csavarhúzó készlet **RO** Set de surubelnite izolate drepte **BG** Комплект отверки 1000 V

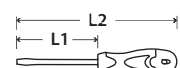

x6	VDE 1000V	S2					
				MAGNETIC	ERGO GRIP	EN 60900	

	⊖	L1	L2		
HT1S996	⊖ 2,5	75 mm	163 mm	6	24
	⊖ 4	100 mm	188 mm		
	⊖ 5,5	125 mm	223 mm		
	⊕ PH0	60 mm	148 mm		
	⊕ PH1	80 mm	178 mm		
	⊕ PH2	100 mm	208 mm		

DE Schraubendreher-Satz 1000 V **EN** Insulated 1000 V screwdriver set **FR** Pack de tournevis isolés 1000 V **ES** Pack de destornilladores aislados 1000 V **HR** Set odvijača, izolirani 1000 V **HU** Csavarhúzó készlet 1000 V **RO** Set de surubelnite 1000 V **BG** Комплект отверки 1000 V



- ⊖ 1,2 x 6,5 x 100 mm,
- 1,0 x 5,5 x 100 mm,
- 0,8 x 4,0 x 100 mm,
- 0,5 x 3,0 x 100 mm
- ⊕ PH2 x 100 mm,
- PH1 x 80 mm,
- PZ2 x 100 mm,
- PZ1 x 80 mm,
- ⊙ T10 x 100 mm,
- T15 x 100 mm,
- T20 x 100 mm
- Voltage tester 140 mm

x13	VDE 1000V	S2	MAGNETIC	ERGO GRIP			
					HT1S997	1	72

DE Schraubendreher-Satz 1000 V **EN** Insulated 1000 V screwdriver set **FR** Pack de tournevis isolés 1000 V **ES** Pack de destornilladores aislados 1000 V **HR** Set odvijača, izolirani 1000 V **HU** Csavarhúzó készlet 1000 V **RO** Set de surubelnite 1000 V **BG** Комплект отверки 1000 V



- ⊖ 5.5 x 100 mm,
- 4.0 x 100 mm
- ⊕ PZ2 x 100 mm
- ⊕ PH2 x 100 mm,
- PH1 x 80 mm
- Keys for switch cabinets:
triangle
square



x8	VDE 1000V	S2	MAGNETIC	ERGO GRIP			
					HT1S998	6	12

HT1S998	6	12		

DE Schlitz-Schraubendreher 1000 V SL **EN** Insulated 1000 V SL screwdriver **FR** Tournevis plat isolé 1000 V SL **ES** Destornillador aislado de punta plana 1000 V SL **HR** Ravni odvijači 1000 V **HU** Szigetelt lapos csavarhúzó **RO** Surubelnite izolate drepte **BG** Отверка 1000 V SL

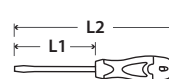

VDE 1000V	⊖ SL	S2		
			MAGNETIC	ERGO GRIP
				EN 60900

	⊖	L1	L2		
HT1S902	2,5	75 mm	163 mm	12	360
HT1S903	3	100 mm	188 mm	12	360
HT1S904	4	100 mm	188 mm	12	360
HT1S905	5,5	100 mm	223 mm	12	240

DE Schlitz-Schraubendreher 1000 V SL SLIM EN Insulated 1000 V SLIM screwdriver
 FR Tournevis à fente isolé 1000 V SL SLIM ES Destornillador plano 1000 V SL SLIM
 HR Ravní odvijači 1000 V SL SLIM HU Szigetelt lapos csavarhűzők RO Surubelnite izolate drepce BG Отверпка 1000 V SL SLIM

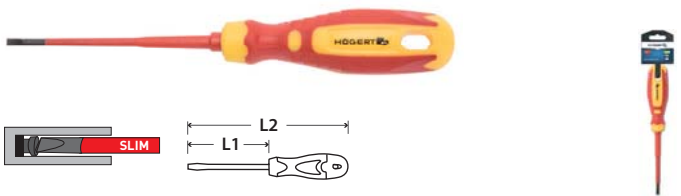

VDE 1000V	SL	SLIM	CrMo						
MAGNETIC	ERGO GRIP	EN 60900							

DE Kreuzschlitzschraubendreher 1000 V PH SLIM EN Insulated 1000 V PH screwdriver
 FR Tournevis isolé 1000 V PH SLIM ES Destornillador philips 1000 V PH SLIM HR Križni odvijači 1000 V, SLIM HU Szigetelt PH csavarhűző RO Surubelnite izolate 1000 V PH SLIM BG Отверпка 1000 V PH SLIM

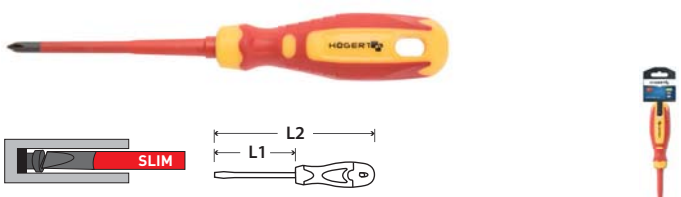

VDE 1000V	PH	SLIM	CrMo						
MAGNETIC	ERGO GRIP	EN 60900							

DE Kreuzschlitzschraubendreher 1000 V PZ SLIM EN Insulated PZ SLIM screwdriver
 FR Tournevis isolé 1000 V PZ SLIM ES Destornillador philips 1000 V PZ SLIM HR Križni odvijači 1000 V, SLIM HU Szigetelt PH csavarhűző RO Surubelnite izolate PH SLIM BG Отверпка 1000 V PZ SLIM

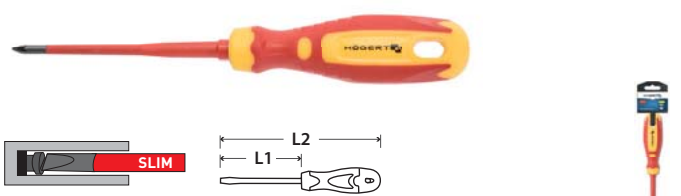

VDE 1000V	PH	SLIM	CrMo						
MAGNETIC	ERGO GRIP	EN 60900							

DE Ringschlüsselset, offen EN Double open-end spanner set FR Jeu de clés à double extrémités ES Juego de llaves fija HR Komplet poluotvorenih okastih ključeva HU Kétoldalú villáskulcs készlet RO Set de chei fixe duble BG Комплект гаечни ключове отворени



x4	CrV	DIN 838							

DE Kreuzschlitzschraubendreher 1000 V PH EN Insulated 1000 V PH screwdriver
 FR Tournevis isolé 1000 V PH ES Destornillador aislado de punta plana 1000 V PH HR Križni odvijači 1000 V HU Szigetelt PH csavarhűzők RO Surubelnite izolate PH BG Отверпка 1000 V PH



VDE 1000V	PH	S2							
MAGNETIC	ERGO GRIP	EN 60900							

DE Kreuzschlitzschraubendreher 1000 V PZ EN Insulated 1000 V PZ screwdriver
 FR Tournevis Pozidriv isolé 1000 V PZ ES Destornillador aislado de punta plana Pozidriv PZ HR Križni odvijači 1000 V PZ HU Szigetelt PZ Pozidriv csavarhűző RO Surubelnite izolate PZ Pozidriv BG Отверпка 1000 V PH PZ



VDE 1000V	PZ	S2							
MAGNETIC	ERGO GRIP	EN 60900							

DE Schraubendreher für Plus-Minus Klemmschrauben EN Insulated 1000 V SLIM screwdriver FR Tournevis à sertir 1000 V ES Destornillador para cuadros de la luz 1000 V, SLIM HR Odvijači 1000 V SLIM HU Szigetelt PH csavarhűzők RO Surubelnite izolate PH BG Отверпка кръст-плоска 1000 V SLIM



VDE 1000V	SLIM	PH							

DE Torx Ringschlüssel-Set EN Torx ring spanner set FR Jeu de Clés à oeil torx ES Llaves planas cabezal torx HR Komplet okastih ključeva torx HU Kétoldalú torx kulcs RO Maner T glisant cu cheie torx BG Ключове звездогачени torx комплект



x4	TORX	CrV							

DE Ringschlüssel Typ "C" EN C-Type Ring Spanner Set FR Jeu de clés plates courbés en forme «C» ES Juego de llaves de estrella en C HR Set okastih "C" ključeva HU C-típusú csillagkulcs készlet RO Set de chei inelare duble tip C BG Комплект звездогаечни ключове, извити, C - форма



8 x 10, 11 x 13, 14 x 15,
16 x 17, 19 x 22 mm



x5 8-22 mm CrV

HT1W599	8-22 mm	6	24
---------	---------	---	----

DE Doppelringschlüsselset EN Bi-hexagonal ring spanner set FR Kit de clés a fourche en acier ES Juego de llaves de estrella, acero HR Komplet okastih ključeva HU Hajlított csillagkulcs készlet RO Set de chei inelare duble cotite BG Комплект звездогаечни ключове, извити



6 x 7, 8 x 9, 10 x 11, 12 x 13,
14 x 15, 16 x 17, 18 x 19,
20 x 22 mm



x8 CrV DIN 838

HT1W598	6-22 mm	1	10
---------	---------	---	----

DE Maul-Ring-Schlüsselset EN Combination spanners set FR Kit de Clés Mixtes a cliquet en acier ES Juego de llaves combinadas HR Komplet okasto-vilíčastih ključeva HU Kombinált villáskulcs készlet RO Set de chei combinate BG Комплект ключове гаечни плоски



6, 8, 10, 11, 12, 13, 14, 15,
17, 19, 22, 24 mm



x12 CrV 15° AS SYSTEM DIN 3113

HT1W492	6-24 mm	1	10
---------	---------	---	----

DE Maul-Ring-Schlüsselset EN Combination spanners set FR Kit de Clés Mixtes a cliquet en acier ES Juego de llaves combinadas HR Komplet okasto-vilíčastih ključeva HU Kombinált villáskulcs készlet RO Set de chei combinate BG Комплект ключове гаечни плоски



6, 7, 8, 9, 10, 11, 12, 13, 14, 15,
16, 17, 18, 19, 20, 21, 22, 23, 24,
25, 26, 27, 28, 29, 30, 32 mm



x26 CrV 15° ASS DIN 3113

HT1W496	6-32 mm	1	4
---------	---------	---	---

DE Schrauben-Ring-Schlüssel EN Combination spanner FR Clés Mixtes en acier ES Llave combinada HR Okasto-viljuškasti ključevi HU Kombinált villáskulcsok RO Chei combinate BG Ключ звездогаечен



DE Schrauben-Ring-Schlüssel mit Ratsche EN Combination ratchet spanner FR Clés Mixtes, en acier ES Llave combinada con trinquete HR Viljuškasto-okasti ključevi s čegrtaljkom HU Kombinált racsnis villáskulcsok RO Chei combinate cu clichet BG Ключ звездогаечен с тресчотка

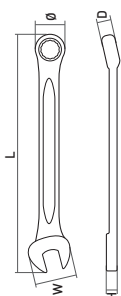

		L	W	Φ	H	D		
HT1W406	6 mm	110	15	10,8	4	4,9	5	300
HT1W407	7 mm	116	17,2	11,8	4,2	5,2	5	300
HT1W408	8 mm	128	19,4	13,5	4,5	5,5	5	300
HT1W409	9 mm	137	21	14,6	4,8	6	5	250
HT1W410	10 mm	148	23,5	16,3	5,2	6,5	5	250
HT1W411	11 mm	157	25,2	17,3	5,5	7	5	250
HT1W412	12 mm	169	27,5	19	5,8	7,5	5	250
HT1W413	13 mm	176	29,4	20	6,1	7,9	5	250
HT1W414	14 mm	186	31,5	22	6,5	8,4	5	150
HT1W415	15 mm	196	33,1	23	6,8	8,8	5	150
HT1W416	16 mm	207	34,8	24,4	7	9,3	5	100
HT1W417	17 mm	219	37	25,6	7,2	9,8	5	100
HT1W418	18 mm	228	38,3	27	7,5	10,3	5	100
HT1W419	19 mm	238	40,8	28,6	7,8	10,8	5	100
HT1W420	20 mm	249	42,6	30	8,1	11,2	5	100
HT1W421	21 mm	260	44,8	31,7	8,4	11,6	5	60
HT1W422	22 mm	270	47,2	33,2	8,7	12,1	5	60
HT1W424	34 mm	289	50,3	35,6	9,3	13	5	60
HT1W425	25 mm	300	52,4	37,2	9,5	13,3	5	60
HT1W426	26 mm	309	54,4	38,6	9,8	13,6	5	60
HT1W427	27 mm	320	5,64	40	10,9	13,9	5	60
HT1W428	28 mm	338	60	42,4	10,5	14,8	5	60
HT1W430	30 mm	352	62,4	44,2	11	15,3	5	60
HT1W432	32 mm	370	66,4	47	11,6	15,7	5	30
HT1W436	36 mm	452	73	51,6	13,2	17,5	5	20
HT1W441	41 mm	480	84	62	15	19	5	20
HT1W446	46 mm	495	94	68	15,5	20	5	20
HT1W450	50 mm	505	103	74	16,5	21	5	20
HT1W455	55 mm	670	109	81	20	29	1	5

CrV 15° AS SYSTEM DIN 3113

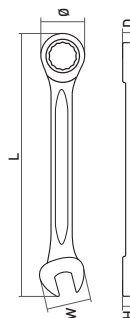

		L	W	Φ	H	D		
HT1R006	6 mm	121	15	14,3	4,5	6,3	5	200
HT1R007	7 mm	130	16,4	16,8	4,8	6,5	5	200
HT1R008	8 mm	140	18	18,3	5,3	7,2	5	200
HT1R009	9 mm	150	20	20	5,7	7,5	5	200
HT1R010	10 mm	160	22	21,5	6	7,8	5	200
HT1R011	11 mm	165	24,5	23,5	6,2	8,4	5	200
HT1R012	12 mm	170	26	25	6,5	8,8	5	200
HT1R013	13 mm	180	28	26,4	6,8	9,1	5	200
HT1R014	14 mm	190	30,8	28	7,2	9,4	5	200
HT1R015	15 mm	200	33	30	7,5	9,8	5	100
HT1R016	16 mm	210	34,5	31,5	7,8	10,2	5	100
HT1R017	17 mm	225	37	33	8,1	10,5	5	100
HT1R018	18 mm	235	39,5	35	8,5	10,8	5	100
HT1R019	19 mm	245	40,8	36,5	8,8	11,2	5	100
HT1R020	20 mm	245	40,8	36,5	8,8	11,2	5	100
HT1R021	21 mm	290	44,8	42,5	9,5	13,5	5	50
HT1R022	22 mm	290	44,8	42,5	9,5	13,5	5	50
HT1R024	24 mm	332	52,8	48,5	10,5	14,5	5	50
HT1R027	27 mm	359	56	53	11,2	15,7	5	40
HT1R030	39 mm	404	62	58	11,7	17	5	20
HT1R032	32 mm	424	65	62	12,3	17,5	5	20

CrV 15° AS SYSTEM DIN 3113

DE Schrauben-Ring-Schlüssel mit Gelenk und Ratsche EN Combination ratchet spanner with flex head FR Clés Mixtes, tête inclinable ES Llave combinada con trinquete articulada HR Ključevi viljuškasto-okasti sa zglobom i čegrtaljkom HU Kombinált racsnis villáskulcsok csuklóval RO Chei combinate cu clichet si capat rotativ BG Ключ звездагаечен с тресчотка с подвижна глава

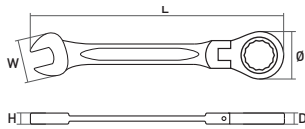

CrV 15° AS SYSTEM DIN 3113



		L	W	Φ	H	D		
HT1R048	8 mm	138	18	18,3	5,3	7,2	5	200
HT1R050	10 mm	158	22	21,5	6	7,8	5	200
HT1R051	11 mm	163	24,5	23,5	6,2	8,4	5	200
HT1R052	12 mm	168	26	25	6,5	8,8	5	200
HT1R053	13 mm	178	28	26,4	6,8	9,1	5	200
HT1R054	14 mm	188	30,8	28	7,2	9,4	5	100
HT1R055	15 mm	196	33	30	7,5	9,8	5	100
HT1R056	16 mm	208	34,5	31,5	7,8	10,2	5	100
HT1R057	17 mm	223	37	33	8,1	10,5	5	100
HT1R058	18 mm	233	39,5	35	8,5	10,8	5	100
HT1R059	19 mm	243	40,8	36,5	8,8	11,2	5	100
HT1R061	21 mm	288	44,8	42,5	9,5	13,5	5	50

DE Tubing Ratschenschlüssel EN Open end flare nut ratchet wrench FR Clé à Cliquet pour Tubes ES Llave de Tubo de Trinquete HR Viličasto-okasti ključ poluotvoreni s čegrtaljkom HU Racsnis kulcs nyitott RO Cheie inelara cu clichet pentru conducte BG Ключ звездагаечен отворен с тресчотка

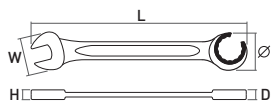

72T CrV

		L	W	Φ	H	D		
HT1R070	8 mm	160	23	28,2	6	13,3	1	10
HT1R071	10 mm	160	23	28,2	6	13,3	1	10
HT1R072	13 mm	190	30	34,7	6,5	14,5	1	10
HT1R073	17 mm	215	36	39,3	7	15,3	1	10
HT1R074	19 mm	230	40	43,5	8,3	16,5	1	10

DE Maul-Ring-Schlüsselset EN Combination spanners set FR Kit de Clés Mixtes en acier ES Juego de llaves combinadas HR Komplet okasto-viljuškastih ključeva HU Kombinált villáskulcs készlet RO Set de chei combinate BG Комплект ключове гаечни плоски



8, 10, 11, 13, 14, 17, 19 mm



x7 CrV 15° AS SYSTEM DIN 3113

HT1W490	8-19 mm	5	20

DE Maul-Ringratschenschlüssel Set EN Combination ratchet spanners set FR Kit de Clés Mixtes, en acier ES Juego llaves combinadas con trinquete HR Combination ratchet spanner set HU Racsnis kombinált villáskulcs készlet RO Set de chei combinate cu clichet BG Комплект ключове звездагаечени с тресчотка



10, 12, 13, 14, 15, 17, 19 mm



x7 CrV 15° AS SYSTEM DIN 3113

HT1R397	10-19 mm	5	20

DE Kombinationszange EN Combination pliers FR Pince universelle ES Alicata universal HR Uniwerzalna kliješta HU Kombinált fogók RO Cleste combinat BG Клещи комбинирани



CrV HRC 58-62 DIN 5746 180° ERGO GRIP

HT1P006	160 mm	6	60
HT1P008	180 mm	6	60

DE Seitenschneider EN Diagonal side cutters FR Pince coupante ES Alicata de corte diagonal HR Bočna kliješta HU Oldalsípő fogók RO Cleste cu taietura laterala BG Клещи резачки



CrV HRC 58-62 DIN 5749 180° ERGO GRIP

HT1P010	160 mm	6	60
HT1P012	180 mm	6	60

DE Flachrundzange, gerade EN Long nose pliers FR Pince à bec long demi-rond ES Alicata de punta larga HR Kliješta izdužena, ravna HU Rádiós fogók RO Cleste cu varf lung BG Клещи угължени прави



CrV HRC 58-62 DIN 5745 180° ERGO GRIP

HT1P016	160 mm	6	60
HT1P020	200 mm	6	60

DE Halbrunde Zangen, gebogen EN Half-round bent pliers FR Pince à bec long demi-rond coudé ES Alicates de punta semirredonda acodado HR Klijesta izdužena, zakrivljena HU Hajlított rádiós fogók RO Cleste cu varf lung, curb BG Клещи "плоскоустни" угължени извити



CrV	HRC 58-62	DIN 5745	180°	ERGO GRIP				
					HT1P022	160 mm	6	60
					HT1P024	200 mm	6	60

DE Halbrunde Zangen, gebogen EN Flat nose pliers FR Pince à bec long plat ES Alicates de punta plana HR Plojsnata klijesta HU Lapos hegyű rádiós fogók RO Cleste cu varf lung, plat BG Клещи "плоскоустни" прави



CrV	HRC 58-62	DIN 5745	180°	ERGO GRIP				
					HT1P026	160 mm	6	60

DE Präzisions-Kombinationszange EN Precision universal pliers FR Pince universelle de précision ES Alicates de precisión universal HR Precizna univerzalna klijesta HU Precíziós univerzális fogók RO Cleste universal de precizie BG Прецизни комбинирани клещи



HRC 50-55	180°	ERGO GRIP						
					HT1P050	125 mm	6	72

DE Präzisions-Seitenschneider EN Precision diagonal cutting plier FR Pince universelle de précision ES Alicates de corte diagonal de precisión HR Precizna bočna klijesta HU Precíziós oldalcsípő fogók RO Cleste de taiere diagonala de precizie BG Прецизни клещи резачки



HRC 50-55	180°	ERGO GRIP						
					HT1P052	115 mm	12	120

DE Präzisions-Flachrundzange, gerade EN Precision long nose pliers FR Pince à bec long demi-rond de précision ES Alicates de punta larga de precisión HR Precizna izdužena klijesta, ravna HU Precíziós rádiós fogók RO Cleste cu varf lung de precizie BG Прецизни универсални клещи удължени



HRC 50-55	180°	ERGO GRIP						
					HT1P054	130 mm	12	120

DE Halbrunde Präzisionszange, gebogen EN Precision bent pliers FR Pince à bec demi-rond de précision ES Alicates de punta semirredonda de precisión HR Precizna izdužena klijesta, zakrivljena HU Precíziós hajlított rádiós fogók RO Cleste cu varf lung, curbat, de precizie BG Прецизни универсални клещи узвити



HRC 50-55	180°	ERGO GRIP						
					HT1P056	125 mm	6	72

DE Präzisions-Kombinationszange EN Precision end cutting pliers FR Pince coupante devant de précision ES Alicates de corte delantero de precisión HR Precizna čeona klijesta HU Precíziós homlokcsípő fogók RO Cleste de precizie cu taietura frontala BG Прецизни клещи керпеден



HRC 50-55	180°	ERGO GRIP						
					HT1P058	115 mm	6	72

DE Allzweckwerkzeuge EN Multipurpose tool FR Pince multifonction ES Herramienta multifunción HR Višenamjenski alat HU Multi-funkciós szerszám RO Scule multifunctionale BG Мултифункционален съгваем нож



2CR13	10 in 1							
					HT1P070	110 mm	12	48

DE Seegerringzange – innen, gerade EN Ring circlip pliers, internal straight FR Pince à circlips interne droite ES Alicates circlips interno recto HR Klijesta za pričvršne prstenove – unutarnja, ravna HU Zégergyűrű fogó, belső egyenes RO Cleste cu falci rotunde, drept, intern BG Зегер клещи вътрешни прави



	Folder	Length	Jaw	Box	Box
HT1P145	150 mm	12-25 mm	6	60	
HT1P141	180 mm	19-60 mm	6	60	

DE Seegerringzange – innen, gekrümmt EN Ring circlip pliers, internal bent FR Pince à circlips interne courbée ES Alicates circlips interno acodado HR Klijesta za pričvršne prstenove – unutarnja, ukošena HU Zégergyűrű fogó, belső hajlított RO Cleste cu falci rotunde, indoit, intern BG Зегер клещи вътрешни закривени



	Folder	Length	Jaw	Box	Box
HT1P147	150 mm	12-25 mm	10	60	
HT1P143	180 mm	19-60 mm	6	60	

DE Seegerringzange – außen, gerade EN Ring circlip pliers, external straight FR Pince à circlips externe droite ES Alicates circlips externo recto HR Klijesta za pričvršne prstenove – vanjska, ravna HU Zégergyűrű fogó, külső egyenes RO Cleste cu falci rotunde, drept, extern BG Зегер клещи външни прави



	Folder	Length	Jaw	Box	Box
HT1P146	150 mm	10-25 mm	6	60	
HT1P142	180 mm	19-60 mm	6	60	

DE Seegerringzange – außen, gekrümmt EN Ring circlip pliers, external bent FR Pince à circlips externe courbée ES Alicates circlips externo acodado HR Klijesta za pričvršne prstenove – vanjska, ukošena HU Zégergyűrű fogó, külső hajlított RO Cleste cu falci rotunde, indoit, extern BG Зегер клещи външни закривени



	Folder	Length	Jaw	Box	Box
HT1P148	150 mm	10-25 mm	6	60	
HT1P144	180 mm	19-60 mm	6	60	

DE Schweißzange, Typ „W“ EN Welding pliers type W FR Pincés à souder, type „W“ ES Alicates de soldadura, tipo „W“ HR Klijesta za zavarivanje, tip „V“ HU HU Hegesztő fogó – „W“ típus RO Cleste pentru sudura tip „W“ BG Клещи чираци заваръчни тип U-form



	Folder	Length	Jaw	Box	Box
HT1P385	230 mm / 9"		10	40	

DE Schweißzange, Typ „C“ EN Welding pliers type C FR Pincés à souder, type „C“ ES Alicates de soldadura, tipo „C“ HR Klijesta za zavarivanje, tip „C“ HU Hegesztő fogó – „C“ típus RO Cleste pentru sudura tip „C“ BG Клещи чираци заваръчни тип C-form



	Folder	Length	Jaw	Box	Box
HT1P386	280 mm / 11"		10	40	

DE Schweißzange flach EN Flat welding pliers FR Pincés à souder plates ES Alicates de soldadura plana HR Klijesta za zavarivanje HU Hegesztő fogók – lapos pófával RO Cleste pentru sudura, plata BG Клещи чираци заваръчни широки челюсти

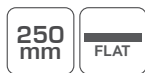

	Folder	Length	Jaw	Box	Box
HT1P387	240 mm		10	40	

DE Drehschraubstock EN Rotary Vice FR Étau pivotant ES Tornillo de banco giratorio HR Okretni škripac HU Satu RO Menghine BG Менгеме с въртяща се основа



	Weight	Length	Jaw	Box	Box
HT3B617	11 kg	125 mm	1	1	
HT3B618	17 kg	150 mm	1	1	
HT3B619	19,5 kg	200 mm	1	1	

HÖGERT
technik



DE Druckluft-Werkzeuge

EN Pneumatic Tools

FR Outils Pneumatiques

ES Herramientas Neumáticas

HR Pneumatski Alati

HU Pneumatikus Szerszámok

RO Instrumente Pneumatice

BG Пневматични Инструменти





DE Pressluftschlagschlüssel mini EN Impact wrench FR Clé à chocs pneumatique mini ES Llave neumática mini HR Pneumatski udarni ključ HU Pneumatikus ütve csavarozó behajtó RO Masina de insurubat cu impact BG Пневматичен ударен гайковерт



1/2"	JUMBO	AI	1/3	L/R
90 PSI/ 6.3 BAR	142.5 l/min	8500 RPM	1.45 kg	

	Nm		
HT4R621	1000 Nm	1	10

DE Pressluftschlagschlüssel EN Impact wrench FR Clé à chocs pneumatique ES Pistola neumática HR Pneumatski udarni ključ HU Pneumatikus ütve csavarozó behajtó RO Masina de insurubat cu impact BG Пневматичена тресчотка



1/2"	TWIN HAMMER	ALUMINIUM COMPOSITE	1/3	L/R
90 PSI/ 6.3 BAR	198 l/min	7000 RPM	2 kg	

	Nm		
HT4R622	610 Nm	1	10

DE Pressluftschlagschlüssel EN Impact wrench FR Clé à chocs pneumatique ES Pistola neumática HR Pneumatski pištolj HU Pneumatikus ütve csavarozó behajtó RO Masina de insurubat cu impact BG Пневматичена тресчотка



1/2"	ALUMINIUM COMPOSITE	1/3	L/R	1/4"
90 PSI/ 6.3 BAR	155 l/min	8000 RPM	2.2 kg	

	Nm		
HT4R623	1500 Nm	1	10

DE Pressluftschlagschlüssel EN Impact wrench FR Clé à chocs pneumatique ES Pistola neumática HR Pneumatski udarni ključ HU Pneumatikus ütve csavarozó behajtó RO Masina de insurubat cu impact BG Пневматичена тресчотка



3/4"	TWIN HAMMER	AI	1/3	L/R
90 PSI/ 6.3 BAR	583 l/min	4600 RPM	7 kg	

	Nm		
HT4R625	2400 Nm	1	2

DE Druckluft Ratschenschrauber EN Air ratchet wrench FR Hochet pneumatique ES Sonajero neumático HR Pneumatska čegrtaljka HU Pneumatikus racsnis behajtó RO Clichet pneumatic BG Пневматична тресчотка



1/2"	MAX 6.2 bar 90 PSI	142 l/min	max: 150 R.P.M.	L/R
262 mm	90 PSI/ 6.3 BAR	142 l/min	150 RPM	

	Nm		
HT4R630	61 Nm	5	20

DE Drucklufteinhandschleifer EN Air grinder FR Perceuse pneumatique ES Taladro neumático HR Pneumatska ravna brusilica HU Pneumatikus egyenes csiszoló behajtó RO Masina de slefuit pneumatica dreapta BG Пневматична шлайфмашина



Ø3-6 mm	MAX 6.2 bar 90 PSI	113 l/min	
max: 22000 R.P.M.	AI	1/4"	

		Ø		
HT4R650	173 mm	6 mm	5	20

DE Druckluft - Bohrmaschine EN Reversible air drill FR Perceuse pneumatique ES Taladro neumático HR Zračna bušilica HU Pneumatikus fúrógép RO Masina de gaurit pneumatica BG Пневматична бормашина



MAX 6.2 bar 90 PSI	142 l/min	max: 1800 R.P.M.
MAX Ø10mm	L/R	

HT4R635	193 mm	3-10 mm	5	20

DE Drucklufteinhandschleifer EN Air eccentric sander FR Pneumatska bušilica ES Perceuse pneumatique HR Pneumatska ekscentrična brusilica HU Pneumatikus excentrikus csiszoló behajtó RO Masina de polisat pneumatic BG Пневматичен ексцентършлайф



MAX 6.2 bar 90 PSI	113 l/min	max: 10000 R.P.M.	5 mm STROKE
--------------------	-----------	-------------------	-------------

	Ø		
HT4R651	150 mm	1	10

DE Druckluft Exzenterschleifer EN Air eccentric sander FR Ponceuse excentrique pneumatique ES Lijadora neumática excéntrica HR Ekscentrična polirka 150 mm sa spremnikom za prašinu HU Excentercsiszoló RO Cheie pneumatică BG Пневматичен ексцентършлайф



90 PSI/ 6.2 BAR	85 l/min	1/4"
10 500 RPM	0.96 kg	5 mm STROKE

HT4R652	150 mm	1	10
---------	--------	---	----

DE Schlagschrauber-Steckschlüssels und Verlängerung EN Flip Impact socket set FR Jeu de douilles à choc bilatérales et de rallonges ES Juego de llaves de impacto de dos caras y prolongadores HR Garnitura udarnih nasadnih ključeva, dvostranih HU Kétoldalú pneumatikus dugókulcs készlet RO Trusa de chei tubulare cu doua carpe BG Комплект ударни вложки, двустранни с удължител



x3	1/2"	17 mm 19 mm 21 mm 22 mm	75 mm	SUPER SLIM	CrMo
----	------	----------------------------------	-------	---------------	------

HT4R006	5	20
---------	---	----

Schlagschrauber-Steckschlüssel Impact socket, deep Douille à choc impact, longue Llave de impacto, larga Udarni nasadni ključ Pneumatikus dugókulcs Chei tubulare pneumatice de impact Ударна дълга вложка



1/2"	DEEP	CrMo	DIN 3121
------	------	------	----------

HT4R010	10 mm	18	108
HT4R011	11 mm	18	108
HT4R012	12 mm	18	108
HT4R013	13 mm	18	108
HT4R014	14 mm	18	108
HT4R015	15 mm	18	108
HT4R016	16 mm	18	108
HT4R017	17 mm	14	84
HT4R018	18 mm	14	84
HT4R019	19 mm	14	84
HT4R020	20 mm	14	84
HT4R021	21 mm	14	84
HT4R022	22 mm	12	72
HT4R023	23 mm	8	48
HT4R024	24 mm	8	48
HT4R027	27 mm	6	36
HT4R030	30 mm	6	36
HT4R032	32 mm	6	36

DE Schlagschrauber-Steckschlüssels EN Impact socket set, deep FR Jeu de douilles à choc impact, longues ES Juego de llaves de impacto, largas HR Garnitura udarnih nasadnih ključeva HU Hosszú pneumatikus dugókulcs készlet RO Trusa de chei tubulare lungi de impact BG Комплект дълги ударни вложки



10, 12, 13, 14, 15,
16, 17, 18, 19, 21, 22,
24, 27, 30, 32 mm



x15	1/2"	DEEP	CrMo	DIN 3121
-----	------	------	------	----------

HT4R049	1	4
---------	---	---

DE Schlagschrauber-Steckschlüssels EN Impact socket set, thin wall FR Jeu de douilles à chocs ES Juego de llaves de impacto HR Garnitura udarnih nasadnih ključeva HU Hosszú pneumatikus dugókulcs készlet RO Trusa de chei tubulare lungi de impact BG Комплект ударни вложки thin wall



x3	1/2"	17 mm 19 mm 21 mm	78 mm	SUPER SLIM	CrMo
----	------	-------------------------	-------	---------------	------

HT4R104	12	24
---------	----	----

DE Schlagschrauber-Steckschlüssel, lang EN Impact socket, deep FR Douille à choc impact, longue ES Llave de impacto, larga HR Udarni nasadni ključ HU Pneumatikus dugókulcsok RO Chei de impact BG Ударна вложка дълга



3/4"	DEEP	CrMo	DIN 3121
------	------	------	----------

HT4R111	19 mm	6	24
HT4R112	21 mm	6	24
HT4R113	24 mm	6	24
HT4R114	27 mm	6	24
HT4R115	30 mm	6	24
HT4R116	32 mm	6	24
HT4R120	36 mm	6	24
HT4R122	41 mm	4	16
HT4R124	46 mm	4	16

DE Schlagschrauber-Steckschlüssel, lang EN Impact socket, deep FR Douille à choc impact, longue ES Llave de impacto, larga HR Udarni nasadni ključ HU Pneumatikus dugókulcsok RO Chei de impact BG Ударна вложка дълга



1"	DEEP	CrMo	DIN 3121
----	------	------	----------

HT4R211	27 mm	4	16
HT4R212	30 mm	4	16
HT4R213	32 mm	4	16
HT4R214	33 mm	4	16
HT4R217	36 mm	4	16

DE Schlag-Verlängerung EN Impact extension bar FR Extension rallonge à choc ES Prolongador llave de impacto HR Udarni produžetak HU Pneumatikus toldó adapter RO Prelungitor pentru chei tubulare de impact BG Ударен удължител



1/2"	CrMo	DIN 3121
------	------	----------

HT4R302	75 mm	20	120
HT4R304	125 mm	20	80
HT4R306	250 mm	20	40

DE Schlag-Verlängerung EN Impact extension bar FR Extension rallonge à choc ES Prolongador llave de impacto HR Udarno proširenje HU Pneumatikus toldó RO Extensii de impact BG Ударен удължител



HT4R315	175 mm	4	16	
HT4R316	250 mm	4	16	

CrMo 3/4" DIN 3121

DE Schlagadapter EN Impact adapter FR Adaptateur à choc ES Adaptador para llave de impacto HR Udarni adapter HU Pneumatikus adapter RO Adaptor de impact BG Ударен адаптер



HT4R324	F 1/2" x M 3/4"	14	84	

CrMo DIN 3121 F 1/2" x M 3/4"

DE Schlagschrauber-Gelenk EN Impact universal joint FR Rotule universelle ES Rótula de bola universal HR Kuglasti zglob HU Golyós kulcs adapter RO Adaptor cu bila BG Универсален кардан



HT4R328	67 mm	10	50	

CrMo 1/2" DIN 3121

DE Druckluft-Schlagschrauber-Nuss Hex EN Bit impact socket hex set FR Jeu de 8 douilles à chocs Hex ES Juego de llaves de impacto, Hex HR Pinski ključevi hex, udarni HU Pneumatikus hex bit kulcsok RO Chei bit de impact hex BG Комплект вложки ударни hex



H6, H7, H8, H10, H12, H14, H17, H19



HT6R004	1	10	

CrMo 1/2" x8

DE Schlag-Verlängerung EN Impact extension bar FR Extension rallonge à choc ES Prolongador llave de impacto HR Udarno proširenje HU Pneumatikus toldó RO Extensii de impact BG Ударен удължител



HT4R320	250 mm	3	12	

CrMo 1" DIN 3121

DE Schlagadapter EN Impact adapter FR Adaptateur à choc ES Adaptador para llave de impacto HR Udarni adapter HU Pneumatikus adapter RO Adaptor de impact BG Ударен адаптер



HT4R326	F 3/4" x M 1"	6	24	

CrMo DIN 3121 F 3/4" x M 1"

DE Druckluft-Schlagschrauber-Nuss Torx EN Bit impact socket torx set FR Jeu de 8 douilles à chocs Torx ES Juego de llaves de impacto, Torx HR Pinski ključevi torx, udarni HU Pneumatikus torx bit kulcsok RO Chei bit de impact torx BG Комплект вложки ударни torx



T30, T40, T45, T50, T55, T60, T70, T80



HT6R002	1	10	

CrMo 1/2" x8

DE Druckluft-Schlagschrauber-Nuss Spline EN Bit impact socket spline set FR Jeu de 8 douilles à chocs Spline ES Juego de llaves de impacto Spline HR Pinski ključevi spline, udarni HU Pneumatikus bit kulcs készlet RO Trusa de chei bit de impact BG Комплект вложки ударни spline



M5, M6, M8, M10, M12, M14, M16, M18



HT6R006	1	10	

CrMo 1/2" x8

DE Lackierpistole mit unterem Saugbecher **EN** Spray Gun **FR** Pistolet pulvérisateur de peinture **ES** Pistola de pintar **HR** Pištolj za prskanje **HU** Szórópisztoly **RO** Pistol de vopsit **BG** Пистолет за боядисване



1000 ml	H.V.L.P.	1.4 mm	130-210 ml/min
170-283 l/min	43 PSI/ 3 BAR	1/4"	

HT4R712	5	10

DE Lackierpistole mit oberem Saugbecher **EN** Spray Gun **FR** Mini Pistolet pulvérisateur de peinture **ES** Pistola de pintar **HR** Pištolj za prskanje **HU** Szórópisztoly **RO** Pistol de vopsit **BG** Пистолет за боядисване



100 ml	H.V.L.P.	0.8 mm	70-110 l/min
28-113 l/min	30 PSI/ 2 BAR	1/4"	

HT4R718	5	20

DE Lackierpistole mit oberem Saugbecher **EN** Spray Gun **FR** Pistolet pulvérisateur de peinture **ES** Pistola de pintar **HR** Pištolj za prskanje **HU** Szórópisztoly **RO** Pistol de vopsit **BG** Пистолет за боядисване



600 ml	H.V.L.P.	1.4 mm	160-240 l/min
170-283 l/min	43 PSI/ 3 BAR	1/4"	

HT4R716	5	10

DE Austauschbare Düse zur Lackierpistole **EN** Replacement nozzle for spray gun **FR** Buse de rechange pour pistolet de peinture **ES** Boquilla de repuesto para la pistola **HR** Izmjenjiva mlaznica za pištolj za lakiranje **HU** Pótfúvóka szórópisztolyokhoz **RO** Duza de schimb pentru pistol de pulverizare **BG** Резервна дюза



Fits to:
HT4R712
HT4R716

HT4R746	1,7 mm	25	50
HT4R747	2,0 mm	25	50

DE Austauschbare Düse zur Lackierpistole **EN** Replacement nozzle for spray gun **FR** Buse de rechange pour pistolet de peinture **ES** Boquilla de repuesto para la pistola **HR** Izmjenjiva mlaznica za pištolj za lakiranje **HU** Pótfúvóka szórópisztolyokhoz **RO** Duza de schimb pentru pistol de pulverizare **BG** Резервна дюза



Fits to:
HT4R718

HT4R748	0,8 mm	25	50
HT4R749	1,2 mm	25	50

DE Blaspistole, kurze und lange Düse **EN** Air blow gun **FR** Soufflette buse courte et longue **ES** Pistola de dar aire, boquilla corta y larga **HR** Pištolj za puhanje **HU** Légfúvópisztoly **RO** Pistol de vopsit aerograf (Air Blow) **BG** Пистолет за въздух



26.5 mm/ 127.0 mm	87 PSI/ 6 BAR	2.0 mm/ 3.6 mm	1/4"
----------------------	------------------	-------------------	------

HT4R750	20	40

DE Gebläse pistole mit verlängerung **EN** Air blow gun **FR** Pistolet à air comprimé **ES** Pistola de aire para soplar **HR** Pištolj za puhanje **HU** Sűrített levegős pisztoly **RO** Pistol cu aer comprimat **BG** Пистолет за въздух



200 mm	116 PSI/ 8 BAR	2.5 mm	1/4"
--------	-------------------	--------	------

HT4R751	10	40

DE Reinigungspistole **EN** Cleaning gun **FR** Pistolet de nettoyage **ES** Pistola de aire a presión. **HR** Pištolj za čišćenje **HU** Tisztító pisztoly **RO** Pistol de suflat **BG** Почистващ пистолет



900 ml	43-58 PSI/ 3-4 BAR	4.5 mm	1/4"
--------	-----------------------	--------	------

HT4R755	10	20

DE Reifenfüllpistole EN Inflating gun FR Pistolet de pompe ES Pistola para inflado HR Pištolj za pumpanje HU Felfújó fej RO Pistol de umflat BG Пистолет за надуване



450 mm
0-12 BAR/
0-174 PSI
1/4"

HT4R757	10	40

DE Reifenfüller EN Inflating gun FR Pistolet de glonflage ES Pistola de aire para inflar larga HR Pištolj za pumpanje HU Felfújó fej RO Pistol de umflare BG Пистолет за надуване



450 mm
0-12 BAR/
0-174 PSI
1/4"

HT4R758	10	40

DE Schnellkupplung EN Quick coupler FR Connecteur rapide ES Conector rápido HR Konektor HU Adapter csatlakozó RO Adaptor cuplaje BG Бърз съединител



HT4R801



HT4R802



HT4R803



HT4R804



15 BAR/
217 PSI
1/4"

HT4R801	F 1/4"	50	100
HT4R802	M 1/4"	50	100
HT4R803	M 6,3 mm	50	100
HT4R804	M 12,5 mm	50	100

DE Endstück für Schnellkupplung EN Quick coupler tip FR Embouts de tuyau ES Terminal para manguera HR Završetak za konektor HU Csatlakozó adapter végelem RO Adaptor cuplaje, terminal BG Адаптер за маркуч



HT4R810



HT4R811



HT4R812



HT4R813



15 BAR/
217 PSI
1/4" x2

HT4R810	F 1/4"	50	100
HT4R811	F 1/4"	50	100
HT4R812	M 6,3	50	100
HT4R813	M 12,5	50	100

DE Kupplung EN Coupler FR Connecteur ES Conector HR Konektor z tuljcem HU Tömlőcsatlakozó RO Cuplaj furtun BG Съединител



ø7.2 mm
15 BAR/
217 PSI

HT4R820	7,2 mm / 8-12 mm	50	100

DE Schnellkupplung EN Quick coupler FR Connecteur rapide ES Conector rápido HR Konektor z tuljcem HU Tömlőcsatlakozó RO Cuplaj furtun BG Съединител



ø7.2 mm
15 BAR/
217 PSI

HT4R821	7,2 mm / 8-12 mm	50	100

DE Filter EN Air filter FR Mini Filtre à Air ES Mini filtro de aire HR Mini filter HU Légszűrő RO Filtru linie aer BG Пневматичен филтър



14 BAR/
203 PSI
1/4" 8 cm³

HT4R870	10	50

DE Druckfilter-Druckminderer EN Air filter-reducer FR Filtre à Air avec manomètre ES Filtro de aire con manómetro HR Filter zraka HU Légszűrő nyomásmérővel RO Filtru linie aer cu manometru BG Пневматичен филтър с манометър



HT4R871



HT4R872



9 BAR/
135 PSI
1/4" 15 cm³ 90 cm³

HT4R871	15 cm	5	20
HT4R872	90 cm	10	20

DE Druckminderer **EN** Reducer **FR** Régulateur avec un manomètre **ES** Regulador con manómetro **HR** Regulator s manometrom **HU** Szabályozó nyomásmérővel **RO** Regulator cu manometru **BG** Пневматичен регулатор с манометър



12 BAR/
174 PSI

1/4"

HT4R873	20	60

DE Druckfilter-Druckminderer und Entöler **EN** Air filter-reducer and lubricator **FR** Filtre régulateur lubrificateur avec manomètre **ES** Filtro del pulverizador de aceite, con manómetro **HR** Filter zraka **HU** Levegőszűrő nyomásmérővel **RO** Filtru linie aer cu manometru **BG** Пневмогрупа: пневматичен филтър с регулатор с омаслител



9 BAR/
135 PSI

1/4"

25 cm³/
15 cm³

HT4R874	5	20

DE Druckfilter-Druckminderer und Entöler **EN** Air filter-reducer and lubricator **FR** Filtre régulateur lubrificateur **ES** Filtro de aire con reductor y pulverizador de aceite **HR** Filter zraka **HU** Levegőszűrő nyomásmérővel **RO** Filtru linie aer cu manometru **BG** Пневмогрупа: пневматичен филтър с регулатор с омаслител



9 BAR/
135 PSI

1/4"

90 cm³/
60 cm³

HT4R875	5	10

DE Entöler **EN** Lubricator **FR** Mini Graisseur à brouillard d'huile **ES** Mini pulverizador de aceite **HR** Mini podmazivač **HU** Levegőtömlő kenő **RO** Gresat pentru furtun cu aer **BG** Омаслител



9 BAR/
135 PSI

1/4"

HT4R876	25	50

DE Druckluftschlauch **EN** Pressure air hose **FR** Tuyau de pression **ES** Manguera de presión **HR** Tlačno crijevo **HU** Légtömlő **RO** Furtunuri de aer **BG** Маркуч за компресор



PU

1/4"

HT4R890	5	8	6	1	50	
HT4R891	10	8	6	1	25	
HT4R892	15	8	6	1	25	
HT4R894	9	12	8	1	25	

DE Technischer schlauch **EN** Pressure air hose **FR** Tuyau de pression **ES** Manguera de presión **HR** Tlačno crijevo **HU** Légtömlő **RO** Air Hose **BG** Маркуч за компресор



PVC

25 m

-5°C
+30°C

FLEX

HT4R897	25	12	8	
HT4R898	25	15	10	
HT4R899	25	18.5	12.5	

HÖGERT
technik

DE KFZ-Werkzeuge
EN Automotive Tools
FR Outils Automobiles
ES Herramientas De Automoción
HR Alati Za Automobile
HU Járműipari Szerszámok
RO Scule Auto
BG Автомобилни Инструменти





HÖGERT
technik
HT8G413

DE Hydraulischer Rangierwagenheber EN Floor jack, low profile FR Ascenseur hydraulique ES Gato hidráulico de ruedas HR Hidraulična dizalica niskog profila HU Alacsony profilú hidraulikus emelő RO Cricuri hidraulice cu profil redus BG Нископрофилен хидравличен крик



Folder	Weight	min mm	max mm	Box	Carton
HT8G004	2 T	89	359	1	1

DE Hydraulischer Rangierwagenheber EN Floor jack, low profile FR Ascenseur hydraulique ES Gato hidráulico de ruedas HR Hidraulična dizalica niskog profila HU Alacsony profilú hidraulikus emelő RO Cricuri hidraulice cu profil redus BG Нископрофилен хидравличен крик



Folder	Weight	min mm	max mm	Box	Carton
HT8G006	2 T	85	455	1	1

DE Hydraulischer Stempelwagenheber EN Hydraulic bottle jack FR Cric hydraulique ES Gato hidráulico HR Jednostupna dizalica u jednom segmentu HU Hidraulikus üveg alakú emelő RO Cric hidraulic forma de sticla BG Подсилен бутилков хидравличен крик



Folder	Weight	min mm	max mm	Box	Carton
HT8G022	5 T	210	405	1	4
HT8G024	8 T	225	440	1	4

DE Unterstellböcke EN Jack stand FR Chandelles auto ES Borriqueta para coche HR Automobilska potpora HU Autó emelő állvány RO Stand de ridicat auto BG Подпори за крик



Folder	Weight	min mm	max mm	Box	Carton
HT8G052	2 T	278	423	1	1
HT8G053	3 T	288	428	1	1
HT8G056	6 T	395	613	1	1

DE Werkstattliege EN Workshop couch FR Chariot de visite ES Camilla para mecánico HR Ležaljka za radionicu HU Műhely kanapé RO Canapea de atelier BG Автомонтьорска лежанка



max	Material	Height	Mounting	Height	Folder	Weight	Box	Carton
110 kg	PE-HD	40"	x6 Ø63	115 mm	HT8G100	1010 x 470 mm	1	1

DE Abzieher, zweiarmig EN Double-arm puller FR Extracteur 2 griffes ES Extractor de rodamientos 2-brazos HR Izvlakač 2-kraki HU Kétkaros leházó RO Instrument de raclet cu doua brate BG Скоба двураменна



Folder	max mm	max mm	Box	Carton
HT8G200	75	60	1	40
HT8G201	100	70	1	20
HT8G202	150	120	1	10
HT8G203	200	175	1	5

DE Abzieher, dreiarmig EN Three-arm puller FR Extracteur 3 griffes ES Extractor de rodamientos 3-brazos HR Izvlakač 3-kraki HU Háromkaros leházó RO Instrument de raclet cu trei brate BG Скоба тринаменна



Folder	max mm	max mm	Box	Carton
HT8G205	75	60	1	40
HT8G206	100	70	1	20
HT8G207	150	120	1	6
HT8G208	200	175	1	4

DE Balken-Zuggerät, zweiarmig EN Crosshead double-arm puller FR Extracteur 2 griffes, auto-serrant ES Extractor de rodamientos de puente trasero 2 brazos HR Izvlakač 2-kraki, s gredom HU Keresztfejű kétkaros leházó RO Dispozitiv de extragere cu brat dublu BG Скоба двураменна



Folder	max mm	max mm	Box	Carton
HT8G210	80	100	1	28
HT8G211	120	100	1	28
HT8G212	150	150	1	9
HT8G213	180	150	1	9

DE Zweiarmiger Abzieher **EN** Two arm bearing puller **FR** Extracteur de roulements à deux griffes **ES** Extractor de rodamientos, de dos brazos **HR** Izvlakač ležajeva, 2 kraka **HU** Két csapágyhúzó **RO** Extractor cu două brațe **BG** Скоба за вадене на лагери двураменна



	\square	\varnothing max mm	\nearrow max mm	kN max		
HT8G215		40	60	10	1	100
HT8G216		65	65	12	1	100
HT8G217		80	80	15	1	100

CS 45
DROP FORGED
TRAPEZOIDAL THREAD

DE Abzieher **EN** Bearing puller **FR** Extracteur de roulement **ES** Extractor de rodamientos **HR** Izvlakač **HU** Fogaskerék-húzó **RO** Tragator **BG** Скоба за вадене на лагери



\square			
HT8G218	12-38 mm	1	20

CrV
12x38 mm
TRAPEZOIDAL THREAD

DE Gelenkabzieher **EN** Joint puller **FR** Extracteur des rotules **ES** Extractor para rodamientos de bolas de transmisiones **HR** Izvlakač za zglobove **HU** Speciális leházó **RO** Extragera articulatiilor **BG** Скоба за шарнири универсална



	\square	\varnothing max mm	\nearrow max mm		
HT8G225		27	45	1	20
HT8G226		30	64	1	20

DROP FORGED
TRAPEZOIDAL THREAD

DE Spurstangengelenk Werkzeug **EN** Steering rod puller **FR** Extracteur de tige de direction **ES** Extractor de varilla de dirección **HR** Upravljača štap tegljač **HU** Kormányrúd telepítő keszlet **RO** Extragera tijă de direcție **BG** Ключ за демонтаж на кормилена крайник



\square	mm	\varnothing		
HT8G227	395 mm	28-35 mm	1	6
HT8G228	400 mm	35-45 mm	1	6

1/2"
27mm

DE Spurstangengelenk Werkzeug **EN** Steering rod puller set **FR** Extracteur de tige de direction **ES** Extractor de varilla de dirección **HR** Upravljača štap tegljač **HU** Kormányrúd telepítő keszlet **RO** Extragera tijă de direcție **BG** Ключ за демонтаж на кормилена крайник



\square	mm	\varnothing		
HT8G229	410 mm	30-45 mm	1	4

1/2"
32mm
x4
30-35 mm
35-40 mm
40-45 mm

DE Kugelgelenkabzieher **EN** Ball joint puller **FR** Extracteur des rotules **ES** Extractor para rodamientos de bolas de transmisiones **HR** Izvlakač za zglobove **HU** Speciális leházó **RO** Extragera articulatiilor **BG** Скоба за шарнири универсална

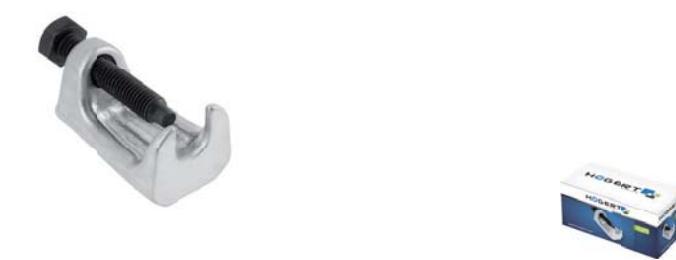

\square	\varnothing max mm	\nearrow max mm		
HT8G230	19	45	1	50

DROP FORGED
TRAPEZOIDAL THREAD

DE Kugelgelenkabzieher **EN** Ball joint puller **FR** Extracteur des rotules **ES** Extractor para rodamientos de bolas de transmisiones **HR** Izvlakač za zglobove **HU** Speciális leházó **RO** Extragera articulatiilor **BG** Скоба за шарнири универсална



\square	\varnothing max mm	\nearrow max mm		
HT8G231	20	62	1	20
HT8G232	17	58	1	20

DROP FORGED
TRAPEZOIDAL THREAD

DE Trenn- und Montagegabel **EN** Ball joint puller **FR** Extracteur des rotules **ES** Desmontable para transmisiones **HR** Vilica za odvajanje zglobova **HU** Csuklós rögzítő **RO** Element de fixare **BG** Вилца за шарнири



\square	\varnothing max mm	mm		
HT8G240	22	300	1	20
HT8G241	27	300	1	20
HT8G242	18	400	1	20

DROP FORGED



DE Federspänner EN Spring puller FR Compresseur de ressorts ES Extractor para muelles HR Izvlakač za opruge HU Rugó lehűző RO Instrument de racla BG Скоби за пружини



×2	21mm	1/2"	DROP FORGED	TRAPEZOIDAL THREAD	355mm	HT8G245	1	10
----	------	------	-------------	--------------------	-------	---------	---	----

DE Federspänner EN Spring puller FR Compresseur de ressorts ES Extractor para muelles HR Izvlakač za opruge HU Rugó lehűző RO Instrument de racla BG Скоби за пружини



×2	24 mm	DROP FORGED	TRAPEZOIDAL THREAD	305 mm	HT8G247	1	20
----	-------	-------------	--------------------	--------	---------	---	----

DE Radnaben Abzieher Satz EN Hub puller FR Extracteur de moyeux ES Extractor de cubos HR Izvlakač čvorišta HU Kerékagy lehűző RO Extragere butuc BG Скоби за демонтаж на главина



×13	DROP FORGED	95/75/45mm	127mm	TRAPEZOIDAL THREAD	HT8G250	1	10
-----	-------------	------------	-------	--------------------	---------	---	----

DEVorrichtung zur Demontage von Motorventilen EN Overhead valve spring compressor FR Un extracteur pour démonter les soupapes du moteur ES Un extractor para desmontar válvulas de motor HR Izvlakač za rastavljanje ventila motora HU Húzó a motorszelepek szétszereléséhez RO Un trăgător pentru dezasambla supape motor BG Комплект със скоба за клапани



engines OHV, OHC, CHV	for VALVES	HT8G252	115 mm	1	20
-----------------------	------------	---------	--------	---	----

DE Federspänner EN Spring puller FR Compresseur de ressorts ES Extractor para muelles HR Izvlakač za opruge HU Rugó lehűző RO Instrument de racla BG Скоби за пружини



×3	24 mm	DROP FORGED	TRAPEZOIDAL THREAD	305 mm	HT8G246	1	8
----	-------	-------------	--------------------	--------	---------	---	---

DE McPherson Federspänner EN McPherson spring puller FR McPherson Compresseur de ressorts ES Extractor de muelles McPherson HR McPherson izvlakač opruge HU McPherson rugóhűző RO Extractor de arc McPherson BG Скоби за пружини (макферсон)



max 2300 kg	100×265 mm	CrMo	HT8G248	1	2
-------------	------------	------	---------	---	---

DE Abzieher für Wischerarme und Batterieklemmen EN Puller for wiper arms and battery terminals FR Extracteur de bras d'essuie-glace et de bornes de batterie ES Extractor de brazos de limpiaparabrisas y terminales de batería HR Izvlakač za skidanje brisača i stezaljki akumulatora HU Lehűző szerszám ablaktörlő karokhoz és az akkumulátor pólusaihoz RO Extractor pentru brațele ștergătorului și bornele bateriei BG С коба за рамото на чистачките



∅ 28 mm	DEPTH 43 mm	STEEL	NYLON	HT8G251	1	1
---------	-------------	-------	-------	---------	---	---

DE Abzieher des vorderen Nabenlagers EN Front hub bearing puller FR Extracteur de roulement de moyeu avant ES Extractor de cojinetes de buje delantero HR Izvlakač ležaja prednje glavčine HU Első agy csapágyhűző RO Extractor pentru lagăre hub-uri frontale BG Скоби за демонтаж на главина пред



210 mm
32, 38 mm
76, 86, 91, 102 mm
86, 102 mm
50, 55, 59, 63, 67, 70, 72, 73, 74, 75, 77, 82, 83, 88 mm



×23	50×88 mm	HT8G253	1	2
-----	----------	---------	---	---

DE Zweiarmabzieher und Abscheider EN Two-arm puller and separator FR Extracteur et séparateur à deux bras ES Extractor y separador de dos brazos HR Dvokraki izvlakač i separator HU Kétkaros lehúzó és elválasztó RO Extragere și separator cu două brațe BG Сепаратор и скоба двуремна за лагери комплект



Folder	Length	Box	Case
HT8G254	5 - 60 mm	1	10
HT8G255	12 - 75 mm	1	10
HT8G256	22 - 115 mm	1	2

x8 40 CR TRAPEZOIDAL THREAD

DE Zweiarmabzieher und Abscheider EN Two-arm puller and separator set FR Extracteur et séparateur à deux bras ES Extractor y separador de dos brazos HR Dvokraki izvlakač i separator HU Kétkaros lehúzó és elválasztó RO Extragere și separator cu două brațe BG Сепаратор на лагери

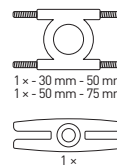

1 x - 9/16" x L 175 mm x 10 T
1 x - 30 mm - 50 mm
1 x - 50 mm - 75 mm
4 x - 17 mm 3/8" x L 127 mm x 16 T
4 x - 14 mm 3/8" x L 102 mm x 16 T



x12 40 CR TRAPEZOIDAL THREAD

Folder	Length	Box	Case
HT8G257	30-75 mm	1	4

DE Nabe und Lagerabzieher EN Hub and bearing puller FR Extracteur de moyeu et de roulement ES Extractor de cubos y cojinetes HR Izvlakač glavnice i ležaja HU Agy és csapágyhúzó RO Butuc și extragere rulment BG Обратен чук (екстрактор) за главини и лагери

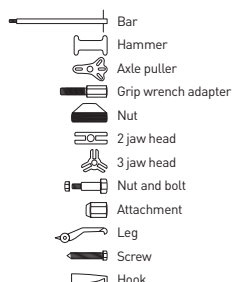

x16 8 in1 2.5 kg 57 cm

Folder	Box	Case
HT8G258	1	1

DE Ölfilterschlüssel EN Oil filter wrench FR Clé pour filtre à huile ES Llave para filtros de aceite HR Ključ za filter ulja HU Olajsűrű kulcs RO Cheie filtru ulei BG Ключ за маслен филтър



STEEL

Folder	Ø	Box	Case
HT8G301	60-73	12	48
HT8G302	73-85	12	48
HT8G303	85-95	12	48
HT8G304	95-111	12	48

DE Akku-Schlagschrauber EN Cordless impact wrench FR Boulonneuse à chocs sans fil ES Llave de impacto sin cable HR Baterija za HT2E200 HU Akkumulátor HT2E200-hoz RO Baterie pentru HT2E200 BG Ударен ключ акумулаторов



20 V 400 Nm BRUSHLESS 2.0 Ah Speed control

Folder	Box	Case
HT2E200	1	4

DE Akku für Schlagschrauber EN Battery for HT2E200 FR Batterie pour boulonneuse à chocs ES Batería para llave de impacto HR Baterija za HT2E200 HU Akkumulátor HT2E200-hoz RO Baterie pentru HT2E200 BG Акумулатор за HT2E200



20 V 2.0 Ah fits to HT2E200

Folder	Box	Case
HT2E210	1	20

DE Ölfilterschlüssel 14 Stk EN Oil filter wrenches FR Clés à filtre à huile 14 pièces ES Llaves para filtros de aceite 14 piezas HR Ključevi za filtere za ulje 14 kom HU Olajsűrű kulcsok 14 db RO Chei filtru ulei 14 buc BG Ключове за маслен филтър



x14 3/8" 1/2" 65x100 mm STEEL

- 65/14 - GM, Daihatsu, Toyota
- 68/14 - Mazda, Ford Escort, Subaru
- 73/14 - Toyota, Lexus
- 76/14 - VW, Porsche, Mercedes, BMW, Audi A3, Opel
- 80/15 - Nissan, Honda, Mazda, Isuzu, Subaru, Opel, Toyota
- 93/15 - Opel, Mazda, Volvo, Mitsubishi, Nissan, VW, Porsche, Renault, Ford, Honda, Audi
- 93/36 - Ford
- 65/67 - Daihatsu
- 80/82 - Mazda, Subaru, Toyota, Honda Acura, Nissan
- 90/15 - Honda Accord, Mitsubishi, Isuzu
- 75/77 - VW, Audi, Ford, Isuzu, Mercedes, Opel
- 76/30 - Ford
- 100/15 - Isuzu, Mitsubishi
- 74/76/15 - VW, Porsche, Mercedes, BMW, Audi A3, Opel



Folder	Box	Case
HT8G306	1	5



DE Ölfilterschlüssel 14 Stk EN Oil filter wrenches FR Clés à filtre à huile 14 pièces ES Llaves para filtros de aceite 14 piezas HR Ključevi za filtere za ulje 14 kom HU Olajszűrő kulcsok 14 db RO Chei filtru ulei 14 buc BG Ключове за маслен филтър



3 arms: 65 - 120 mm
 Adapter 10 mm (3/8") x 12,5 mm (1/2")
 65/14 - Daihatsu, Toyota, Nissan, Fiat
 65/67 /14 Daihatsu, Toyota
 66/6 Fiat Punto 1.2, Renault
 68/14 Mazda, Ford Escort, Subaru
 73/14 - Toyota, Lexus
 74/15 - Audi, GM, Rover, Chrysler
 74/76/15 - Ford, Opel, VW, Audi, Mercedes
 75/77 /15 VW, Audi, Ford, Isuzu, Mercedes, Opel
 76/8 Fiat Marea, Lancia Delta
 76/12 Fiat, Renault, Mercedes
 76/30 - Ford, Motorcraft FL400A
 78/15 - Nissan, Ford, Toyota
 80/15 - Nissan, Honda, Opel, Mazda
 80/82/15 Subaru, Toyota, Honda, Mazda, Nissan

86/16 Volvo S40/ S60/ S70/ S80
 86/18 VW, Audi, Renault, Peugeot, Citroen
 90/15 - Subaru, Toyota, Honda, Mazda, Nissan
 92/10 - Fiat, Lancia
 93/15 - Mazda, Volvo, Mitsubishi, Nissan, Honda
 93/36 - Ford Motorcraft FLINFLA 1 B, FL3001, FL320
 93/45 VW, Audi
 95/5 - Toyota, Alfa, GM, Ford, Chrysler
 96/18 VW, Renault
 100/15 - Isuzu, Mitsubishi
 106/15 - Fiat Ducato 2.5D
 108/15 - Volvo Diesel C70/ S70/ N70/ 850 TDI
 108/18 Renault Espace/ Laguna/ Master/ Safrane/ Trafic 2.4 + 2.5 + 2.8D + TDI

x30	60x120 mm	3/8" / 1/2"	STEEL
-----	-----------	-------------	-------

HT8G307	1	2

DE Universal-Ölfilterschlüssel EN Universal oil filter wrench FR Clé pour filtre à huile universelle ES Llave universal para filtros de aceite HR Ključ za filter ulja univerzalan HU Multifunkciós olajszűrő kulcs RO Cheie filtru ulei multifunctional BG Ключ универсален за маслен филтър



STEEL	3/8" / 1/2"		65x120 mm
-------	-------------	--	-----------

HT8G305	1	40

DE Kreuzschlüssel EN Wheel wrench FR Clé démonte-roue ES Llave para ruedas HR Ključ za kotače HU Kerékkulcs RO Cheie roata auto BG Кръстат ключ



1/2"		17/19/21 mm	STEEL
------	--	-------------	-------

	mm		
HT8G310	350 mm	1	20

DE Kreuzschlüssel EN Foldable wheel wrench FR Clé démonte-roue pliable ES Llave para ruedas plegable HR Ključ za kotače na sklapanje HU Összehajtható kerékkulcs RO Cheie roata auto plianta BG Кръстат ключ съваема



1/2"		17/19/21 mm	CrV
------	--	-------------	-----

	mm		
HT8G311	450 mm	1	10

DE Digitales Reifendruckmessgerät EN Digital tire pressure gauge FR Manomètre numérique pour pneumatiques ES Medidor digital de presión de neumáticos HR Digitalni mjerač guma HU Digitális gumiabroncsmérő RO Gabarit digital de anvelope BG Цифров манометър за налягане в гумите



max 150 PSI 10 BAR	max 10 kg/cm ² 1000 kPa	5-50°C	
PSI-BAR kg/cm ² kPa	 1 x 3 V CR2032 3 x 1.5 V LR44	+/- 1.5%	LED LIGHT

HT8G314	2-150 PSI	12	144

DE Reifenheber EN Tyre bead breaker FR Démonte-pneu ES Palanca para neumáticos HR Žlica za gume HU Gumiabroncs feszítő kulcs RO Dispozitiv de scoatere a anvelope-lor auto BG Щанга за гуми



CrV	DROP FORGED
-----	-------------

HT8G315	400 mm	25	50
HT8G316	500 mm	25	50

DE Drehmomentschlüssel für Gummi- und Metallventile EN Dynamometric key for rubber and metal valves FR Clé dynamométrique pour soupapes en caoutchouc et métalliques ES Llave dinamométrica para válvulas de neumáticos HR Ključ za zakretni moment za gumene i metalne ventile HU Kulcs gumi és fém szelepekhez RO Cheie pentru supape din cauciuc și metal BG Ключ за гумени и метални клапани



RUBBER STEEL	CLIMA	
--------------	-------	--

HT8G317	1	250

DE Drehmomentschlüssel für Ventile EN Torque wrench for valves FR Clé dynamométrique pour vannes ES Llave dinamométrica para válvulas HR Moment ključ za ventile HU Nyomatékkulcs szelepekhez RO Cheie dinamometrică pentru supape BG Ключ динамометричен за клапани



RUBBER STEEL CLIMA AV

HT8G318	max 0,25 Nm	50	100	
HT8G319	max 0,45 Nm	50	100	

DE Glühkerzenschlüssel EN Spark plug wrenches FR Clés à bougies ES Juego de llaves para bujías HR Ključevi za svjećice žarnice HU Izzítógyertya kulcsok RO Chei tubulare pentru bujii BG Комплект вложки за автомобилни подгръващи свещи



x6
3/8" 160mm 17mm CrV

HT8G320	8, 9, 10, 12, 14, 16 mm	1	5	

DE Öllasschlüssel EN Oil drain plug keys FR Clés de vidange ES Llave para vaciado del aceite HR Ključevi za ispuštanje ulja HU Leeresztő dugó kulcsok RO Chei cu dop de goliere BG Вложки за картерни пробки



- 165 mm
- ⊙ 7, 8, 10, 11, 12, 13, 14
- ⊙ 5/16", 3/8"
- ⊙ 8, 9, 10, 12, 14, 17
- ⊙ 10
- ⊙ 10

HT8G321	1	10	

x18 3/8" CrV

DE Spurstangenschlüssel EN Steering rod wrench FR Clé pour biellettes de direction ES Llave de barra de dirección HR Ključ za štap upravljača HU Kormányrúd kulcs RO Cheie pentru ghidon BG Ключ за кормилни накрайници



1/2" 35-42 mm STEEL

HT8G322	1	24	

DE Lambdasondenschlüssel EN Lambda probe key FR Clé pour sonde Lambda ES Llave para sonda Lambda HR Ključ za sondu Lambda HU Lambda szonda kulcs RO Chei sonde lambda BG Ключ за лямбда сонда



1/2" 22 mm LENGTH 50 mm for VW, BMW, Audi, Ford, Skoda, SEAT CrMo

HT8G323	15	60	

DE Lambdasondenschlüssel EN Lambda probe key FR Clé pour sonde Lambda ES Llave para sonda Lambda HR Ključ za sondu Lambda HU Lambda szonda kulcs RO Chei sonde lambda BG Ключ за лямбда сонда



3/8" 22 mm LENGTH 80 mm 8 mm CrV

HT8G324	1	50	

DE Lambdasondenschlüssel EN Lambda probe key FR Clé pour sonde Lambda ES Llave para sonda Lambda HR Ključevi za sondu Lambda HU Lambda szonda kulcs RO Chei sonde lambda BG Ключовеца за лямбда сонда



x3 1/2" 3/8" 22 mm CrV CrMo

HT8G325	1	20	

DE Steckschlüsselsatz für Lambda-sonde und Injektoren EN Set of socket wrenches for lambda probe FR Set de clés à douilles pour sonde Lambda et injecteurs ES Juego de llaves de vaso para sonda Lambda y inyectoros HR Komplet nasadnih ključeva za Lambda sondu i brizgaljke HU Lambda szonda kulcs és injektor kulcs készlet RO Set de chei tubulare pentru sonda lambda si injectoare BG Комплект за лямбда сонда и инжектори



x7 1/2" 3/8" CrV CrMo

HT8G326	22	3/8"	30	80		1	10
	22	1/2"	50	60			
	22	3/8" 27mm	90	-			
	22	3/8" 27mm	80	-			
	27	3/8" 30mm	75	-			
	29	1/2"	90	-			
	27	1/2"	80	-			

DE Reinigungssatz für Einspritzdüsen EN Universal injector seat cleaning set FR Kit de nettoyage de douille d'injecteur ES Kit de limpieza de casquillos de inyectores HR Komplet za čišćenje utičnice mlaznice HU Befecskendező aljzat tisztító készlet RO Set curățare priză injector BG Комплект фрези за почистване леглата на дизелови инжектори



x14
3 x steel
2 x silicon

HT8G327	1	5

DE Zündkerzensteckdose Reparatursatz EN Water pump wrench FR Kit réparation de filetage de bougies d'allumage ES Kit de reparación de roscas de bujía HR Ključ vodene pumpe VAG HU VAG vizszivattyú kulcs RO Chei pentru pompa de apa VAG BG Ключ за водна помпа



32,5 mm VAG LENGTH 245 mm

HT8G328	245 mm / 32,5 mm	6	36

DE Zündkerzensteckdose Reparatursatz EN Water pump wrench FR Kit réparation de filetage de bougies d'allumage ES Kit de reparación de roscas de bujía HR Ključ vodene pumpe VAG HU VAG vizszivattyú kulcs RO Chei pentru pompa de apa VAG BG Ключ за водна помпа



30,5 mm VAG LENGTH 295 mm

HT8G329	295 mm / 30,5 mm	6	36

DE Fühlerlehre EN Feeler gauge FR Jauge d'épaisseur ES Medidor de espesores HR Mjerač zazora ventila HU Hézagoló RO Manometru BG Лупфомер



75 mm 13 mm

HT8G330	9 sheets	0,04-0,3 mm	10 200
HT8G331	31 sheets	0,004 - 0,88 mm	10 200

DE Stahlklemmzange EN Boot clamp pliers FR Pince pour colliers en acier ES Alicata para abrazaderas de acero HR Klijesta za čelične sigurnosne prstene HU Acél bilincsfogó RO Cleste de prindere din oțel BG Клещи за скоби за водни съединения



1/2" LENGTH 245 mm Cr-V

HT8G340	6	36

DE Benzinleitungs-Zange EN Fuel feed pipe pliers FR Pince pour conduits de carburant ES Alicata para líneas de combustible HR Klijesta za cijevi goriva HU Üzemenyag-adagoló cső fogó RO Cleste pentru conducte de alimentare cu combustibil BG Клещи за демонтаж на маркучи на горивната система



Al LENGTH 205 mm

HT8G341	10	30

DE Leitungszange Arbeitsbereich EN Hose removing pliers, operating rage FR Pince pour démonter des conduits ES Pinza sacacables HR Klijesta za uklanjanje crijeva HU Tömlő eltávolító fogó RO Cleste pentru îndepărtarea furtunului BG Клещи за демонтаж на маркучи



5-15 mm 5-30 mm LENGTH 200 mm STEEL

HT8G342	10	50

DE Zündkabelzange EN Ignition cable pliers FR Pince pour conduits d'allumage ES Alicates para cables de arranque HR Klijesta za kablove za paljenje HU Gyújtóhuzal fogó RO Cleste de sarma de aprindere BG Клещи за кабели на свещи



LENGTH 255 mm STEEL

HT8G343	10	40

DE Federbandschellen-Zange, gerade EN Pliers for ties and clamps, straight FR Pince pour colliers et serrages, droite ES Alicates para cables de arranque, rectos HR Klijesta za sigurnosne prstene i stezaljke za proširenje, ravna HU Egyenes bilincs fogó RO Cleste de prindere drepte BG Клещи за скоби за водни съединения, прав шлиц



HT8G344	6	30

DE Federbandschellen-Zange, gebogen EN Pliers for ties and clamps, bent FR Pince pour colliers et serrages, courbée ES Alicates para cables de arranque, rectos, 45°, 215 mm HR Klijesta za sigurnosne prstene i stezaljke za proširenje, zakrivljena HU Hajlított bilincsfogó RO Cleste cu cleme indoite BG Клещи за скоби за водни съединения, извити с прав шлиц

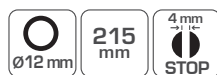

HT8G345	6	30

DE Federbandschellen-Zange, flexibel EN Pliers with a tie cable FR Pince avec câble pour colliers ES Alicates con cable para abrazaderas HR Klijesta za crijevne objumice sa lancem HU Tömlőbilincs kábelfogó RO Cleste pentru cablu de prindere a furtunului BG Клещи за водни съединения, гъвкаво жило



HT8G346	15	30

DE Schlauchklemmenzange für CLIC und CLIC-R Klemmen EN Hose clip pliers CLIC and CLIC-R FR Pince pour collier du type CLIC et CLIC-R ES Alicates para abrazaderas tipo CLIC y CLIC-R HR Klijesta za sigurnosne prestene CLIC i CLIC-R HU Tömlőbilincs fogó [CLIC és CLIC-R] RO Cleste cu cleme pentru furtun (CLIC si CLIC-R) BG Клещи за скоби тип "Click" и "Click R"



HT8G347	10	50

DE Auswuchtgewichtzange EN Wheel balance pliers FR Pince pour équilibrage des roues ES Alicates para equilibrado de ruedas HR Klijesta za balansiranje kotača HU Kerékgyensúly beállító fogó RO Cleste de balansare a rotitor BG Клещи - чук за тежести за баланс на гуми



HT8G348	10	50

DE CV-Gelenkklemmenschettenzange EN CV joint clamp boot pliers FR CV Pince botte de serrage joint ES Alicates de bota de abrazadera de junta homocinética HR Klijesta za stezaljke sa CV spojnicom HU Fogó rögzítő acél kapcsolatok RO Cleste pentru montarea legăturilor din oțel BG Инструмент за водни съединения



HT8G349	10	30

DE Pneumatische Vorrichtung zur Montage der Gelenkabdeckungen EN Pneumatic CV joint boot install tool FR Dispositif pneumatique pour le montage des couvercles des articulations ES Dispositivo neumático para el montaje de las tapas de las juntas. HR Pneumatski uređaj za postavljanje poklopaca spojeva HU Pneumatikus eszköz az ízületek burkolatának felszereléséhez RO Dispozitiv pneumatic pentru montarea caracelor rosturilor BG Пневматичен инструмент за монтаж на маншони на място



HT4R781	1	4

DE Nockenwellen-Arretierung EN Camshaft lock FR Blocages du mécanisme de distribution ES Bloqueo de sistema de distribución HR Blokada bregastog vratila HU VAG vezérműtengely zár RO Blocare arborele cu came BG Инструмент за блокиране на разпределителен вал



HT8G360	10	40

VAG motors:
16 V - 1,4, 1,6: FSI - 1,4, 1,6;
VW - Lupo, Polo, Caddy, Beetle, Golf, Bora (97-10);
Audi - A2 (00-06);
Skoda - Fabia, Fabia II, Octavia, Octavia II, Roomster (99-09)



DE Nockenwellen-Arretierung **EN** Camshaft lock **FR** Blocages du mécanisme de distribution **ES** Bloqueo de sistema de distribución **HR** Blokada bregastog vratila **HU** VAG vezérműtengely zár **RO** Blocare arborele cu came **BG** Инструмент за блокиране на разпределителен вал



VAG motors:
16 V - 1,4, 1,6; FSI - 1,4, 1,6;
VW - Lupo, Polo, Caddy, Beetle,
Golf, Bora (97-10);
Audi - A2 (00-06);
Skoda - Fabia, Fabia II, Octavia,
Octavia II, Roomster (99-09)



x6 VAG

HT8G361	10	40

DE Nockenwellen-Arretierungen **EN** Camshaft lock **FR** Blocages du mécanisme de distribution **ES** Bloqueos de sistemas de distribución **HR** Blokade bregastog vratila **HU** VAG vezérműtengely zár **RO** Blocare arborele cu came **BG** Инструмент за блокиране на разпределителен вал



Opel
Rover
VW
Citroen
Ford
Fiat
Peugeot
Isuzu



x8 NYLON STEEL

HT8G362	1	10

DE Universale Nockenwellenrad-Arretierung **EN** Universal twin cam locking tool **FR** Blocage universel des rouleaux de la distribution **ES** Bloqueo de árboles de levas universal **HR** Univerzalno zaključavanje bregastog vratila **HU** Univerzális ikerkamrás reteszelő **RO** Instrument universal de blocare a camelor duble **BG** Универсален инструмент за блокиране на разпределителен вал



10-180 mm DIESEL PETROL

HT8G363	5	20

DE Universalabzieher für Zahnscheiben **EN** Universal puller for timing pulleys **FR** Extracteur de poulie de la distribution universel **ES** Extractor universal para rueda árbol de levas **HR** Univerzalni izvlačač kotura za pojas **HU** Univerzális vezérműtengely lehúzó **RO** Extractor universal flutie de distribuție **BG** Скоба за демонтаж на шайби и ролки



60-90 mm 16mm 24mm CrV

HT8G364	1	10

DE Unterdruckpumpe für das Bremssystem **EN** Vacuum pump for the brake system **FR** Pompe à dépression pour système de freinage **ES** Bomba de vacío para sistema de frenado **HR** Vakuumpumpa za kočioni sustav **HU** Vákuumszivattyú a fékrendszert **RO** Pompa de vid pentru sistemul de franare **BG** Ръчна вакуум помпа за спирачна система



x16 1 BAR 15 PSI 4 BAR 58 PSI

HT8G370	5	10

DE Satz zum Austausch von Bremsbacken **EN** Brake tool set **FR** Set de remplacement des mâchoires des freins **ES** Juego de herramientas para zapatos de freno **HR** Komplet za zamjenu kočnih cipela **HU** Fékpófa cserkészlet **RO** Set de inlocuire sabot de frana **BG** Комплект за смяна на спирачни челюсти



x8 for DRUM BRAKE LENGTH 325 mm

HT8G371	1	5

DE Scheibenbremsenspreizer **EN** Disc brake separation **FR** Séparateur pour freins à disques **ES** Separador de pistones de freno **HR** Odvajač za disk kočnice **HU** Tárcsafék elválasztó **RO** Separator de frana cu disc **BG** Сепаратор за спирачни апарати



13-87 mm 1/2"

HT8G372	1	30

DE Universaler Bremssattelschlüssel **EN** Disc brake piston tool **FR** Clé universelle pour étrier des freins **ES** Llave universal para pinzas de freno **HR** Univerzalni ključ za kočione stezaljke **HU** Tárcsafék dugattyú szerszám **RO** Instrument cu piston de frana cu disc **BG** Универсален ключ за спирачен апарат



10 mm 3/8" CrMo

HT8G373	25	100

DE Bremskolben-Rückstellsatz **EN** Universal caliper wind back kit **FR** Set repousse-piston pour étriers de freins **ES** Juego de montaje de pistones de freno **HR** Set odvajaca za kočione čeljusti **HU** Univerzális féknyereg szélvédő készlet **RO** Set universal de etrier pentru vant **BG** Комплект сепаратор за спирачни системи



Alfa Romeo	Mazda	Saab
Audi	Mercedes	Seat
BMW	Mitsubishi	Skoda
Citroen	Nissan	Subaru
Fiat	Opel	Toyota
Ford	Peugeot	VW
Honda	Renault	Volvo
Jaguar	Rover	



x18

HT8G374	1	5

DE Pneumatischer Abscheider für Bremssättel **EN** Pneumatic brake caliper fawind tool kit **FR** Séparateur d'étrier de frein pneumatique **ES** Separador de pinza de freno neumático **HR** Pneumatski separator čeljusti kočnice **HU** Pneumatikus féknyereg-elválasztó **RO** Separator de etrier pneumatic de frână **BG** Комплект пневматичен сепаратор за спирачни системи



x4

6 BAR
91 PSI

20-35 mm

2/3 PIN

L/R

HT4R780	1	5

DE Bremsschlauchbieger **EN** Brake hose bender **FR** Cintreuse de tuyaux de frein **ES** Curvadora para tubos de freno **HR** Savijač kočionih crijeva **HU** Féktömlő hajlító **RO** Îndoitor furtun frână **BG** Инструмент за огъване на метални кабели



∅
 4.75, 6.35, 7.95; 9.53 mm
 3/16", 1/4", 5/16", 3/8"



4.75 - 9.53 mm

for tubes
Cu, Al

HT8G375	1	1

DE Universalabscheider für Bremssättel **EN** Universal separators for brake calipers **FR** Séparateurs universels pour étriers de frein **ES** Separadores universales para pinzas de freno **HR** Univerzalni separatori za čeljusti kočnica **HU** Univerzális elválasztók féknyereghez **RO** Separatoare universale pentru etrierele de frână **BG** Универсалени сепаратори за спирачен апарат



∅ 4 mm

3/8"

VAG

EPB
Electronic Park Brake

2/3 PIN

HT8G376	10	50

DE Panel-Entfernungs-Set **EN** Panel removal set **FR** Outils de démontage de la garniture **ES** Extractores para tapicería **HR** Skideri za preslake **HU** Kárpit eltávolító készlet **RO** Set pentru eliminarea panoului **BG** Комплект инструменти за демонтаж на авто панели



x5

NYLON

HT8G390	5	20

DE Panel-Entfernungs-Set **EN** Panel removal set **FR** Outils de démontage de la garniture **ES** Extractores para tapicería **HR** Skideri za preslake **HU** Kárpit eltávolító készlet **RO** Set pentru eliminarea panoului **BG** Комплект инструменти за демонтаж на авто панели



x6

NYLON

HT8G391	6	24

DE Meißel-Schaber **EN** Panel removal set **FR** Grattoirs **ES** Cinceles rasquetas **HR** Dlijeta strugači **HU** Véső lehúzó készlet **RO** Set de raziure de dalta **BG** Комплект пластмасови длета за демонтаж



x4

NYLON

19/22/25/38 mm

HT8G392	265 mm	6

DE Klemme für Polsterstifte **EN** Clamp for upholstery pins **FR** Arrache-agrafes **ES** Extractor para clips de fijación de tapicería **HR** Uklanjač spojnice za tapaciranje **HU** Kárpit patent kiszedő **RO** Extractor capse tapițerie **BG** Комплект инструменти за демонтаж на авто панели

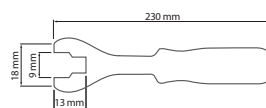

LENGTH
230 mm

HT8G393	16	64

DE Abstreiferset EN Scraper set FR Jeu de grattoirs ES Juego de raspadores HR Set strugala HU Kaparó készlet RO Set de racletă BG Комплект инструменти за демонтаж на авто панели



x5	STEEL	PP	scrapers 260 mm 225 mm	hooks 220 mm 165 mm	needle 210 mm			
						HT8G394	6	36

DE Schraubenausdreher-Satz EN Extractors for bolts with broken drill bits FR Extracteurs des boulons cassés avec mèches ES Machos de izquierdas para tornillos partidos con brocas HR Odvijaci za vadenje polomljenih vijaka s svrdlama HU Csavar kiemelő fűrő-bitefejjel a törött csavarokhoz RO Extractoare cu surub cu burghie pentru suruburi rupte BG Комплект за възстановяване на резби



2, 3, 4, 5, 7, 10 mm

M3-M6, M6-M8, M8-M10, M11-M14, M14-M18, M18-M24

x12	M3-M24	HSS						
			HT8G400	M3-M24	1	36		

DE Schraubenausdreher EN Twist socket set FR Extracteurs des boulons 10-19 mm, 3/8", CrMo, 10 pcs ES Extractores para tornillos HR Ekstraktori za vadenje vijaka HU Csavar kiemelő készlet RO Set de extractoare de suruburi BG Экстрактори за гайки



10, 11, 12, 13, 14, 15, 16, 17, 19 mm



x10	3/8"	HRC 52-55	CrMo			
				HT8G401	1	20

DE Stehbolzen-Ausdreher Satz EN Bolt extractors set FR Extracteurs des goujons ES Extractores para pernos HR Ekstraktori za vadenje pinova HU Csavar kiemelő készlet RO Set de chei pentru extragere prin rasucire BG Комплект за изваждане на скъсани болтове



2, 3, 4, 6, 8, 10 mm.



x6	3/8"	HRC 49-52	CrMo			
				HT8G402	1	20

DE Stehbolzen-Ausdreher Satz 8-16 mm, 1/2", 5 tlg. EN Bolt extractors set FR Extracteurs des goujons ES Extractores para pernos HR Ekstraktori za vadenje igla HU Csavar kiemelő készlet RO Set de chei pentru extragere prin rasucire BG Комплект за изваждане на скъсани болтове



8, 10, 12, 14, 16 mm.



x5	1/2"	HRC 49-52	CrMo			
				HT8G403	1	20

DE Schraubenausdreher EN Screw nuts FR Extracteurs des boulons ES Machos de izquierdas para tornillos 6 uds. HR Ekstraktori za vadenje vijaka HU Csavar kiemelő készlet RO Extractoare de surub BG Комплект за възстановяване на резби



M3-M6, M6-M8, M8-M11, M11-M14, M14-M18, M18-M25



x6	M3-M24			
		HT8G404	12	48

DE Zündkerzensteckdose Reparatursatz EN Spark plug socket repair kit FR Kit réparation de filetage de bougies d'allumage ES Kit de reparación de roscas de bujía HR Komplet za popravak navoja svjećice HU Gyújtógyertya menetjavító készlet RO Kit de reparație a prizei bujiei BG Комплект за ремонт на резби на запалителни свещи



M10-M18	M10 x1.0	M12 x1.25	M14 x1.5			
M18 x1.5	HRC 50	STEEL				
				HT8G405	8	96

DE Reparatursatz für Lambdasondenbuchse EN Lambda probe socket repair kit FR Kit réparation de filetage de sonde lambda ES Kit de reparación de roscas de sondas lambda HR Komplet za popravak osjetnika Lambda HU Lambda szonda menetjavító készlet RO Kit reparație prize sondă Lambda BG Комплект за ремонт на резби сонда Lambda



M12-M18	M12 x1.25	M18 x1.5	HRC 50	STEEL			
				HT8G406	8	96	

DE Kompressionstester für Dieselmotore **EN** Compression pressure gauge for diesel engines **FR** Appareil de mesure de pression pour moteurs Diesel **ES** Medidor de presión de compresión en motores diésel **HR** Manometar kompresije tlaka za dizelske motore **HU** Kompressziós nyomásmérő dízelmotorokhoz **RO** Manometru de compresie pentru motoare diesel **BG** Комплект за измерване на компресия на дизелови двигатели



M8 x 1/102 mm M12 x 1,25/51 mm
 M10 x 1/83 mm M18 x 1,5/160 mm
 M10 x 1/91 mm M20 x 1,5/75 mm
 M10 x 1/119 mm M22 x 1,5/75 mm
 M10 x 1/113 mm M22 x 1,5/118 mm
 M10 x 1,25/67 mm M24 x 1,5/88 mm
 M10 x 1,25/135 mm M24 x 2/63 mm



x16	70 BAR	1015 PSI	FOR DIESEL
-----	--------	----------	------------

HT8G410	1	5
---------	---	---

DE Kompressionsmanometer **EN** Compression pressure gauge **FR** Compressiomètre à manomètre **ES** Medidor de presión de compresión **HR** Tester kompresije za benzinske motore **HU** Kompressziós nyomásmérő **RO** Manometru de compresie **BG** Комплект за измерване на компресия на дизелови двигатели бензинови двигатели



M10 x 1.00, M12 x 1.25
 M14 x 1.25, M18 x 1.50



x8	300 PSI 20 BAR	490 mm	150 mm	150 mm
----	-------------------	--------	--------	--------

HT8G412	1	1
---------	---	---

DE Öldruckprüfer **EN** Oil pressure tester **FR** Testeur de pression d'huile **ES** Tester de presión de aceite **HR** Ispitivač tlaka ulja **HU** Olajnyomás diagnosztikai készlet **RO** Tester de presiune a uleiului **BG** Тестер за налягане на горивото



M10 x 1.0 1/8" x 27 NPT
 M12 x 1.5 1/4" x 20 UNF
 M14 x 1.5 3/8" x 20 UNF
 M16 x 1.5 1/2" x 20 UNF
 M18 x 1.5 R1/8"



x12	10 BAR 140 PSI	1,2 m	PETROL	DIESEL
-----	-------------------	-------	--------	--------

HT8G414	1	10
---------	---	----

DE Kraftstoffeinspritzdruckprüfgerät **EN** Fuel injection pressure tester set **FR** Testeur l'injection de carburant sous pression **ES** Tester de presión de combustible de inyectores **HR** Komplet ispitivača za tlak goriva **HU** Üzemanyag nyomásmérő befecskendezéssel **RO** Tester de presiune a combustibilului cu injecție **BG** Тестер на горивният инжекцион



x10	7 BAR 100 PSI
-----	------------------

HT8G416	1	10
---------	---	----

DE Kompressionstester für Benzinmotore **EN** Compression pressure gauge **FR** Appareil de mesure de pression de la compression **ES** Medidor de presión de compresión **HR** Manometar tlaka kompresije **HU** Kompressziós nyomásmérő **RO** Manometru de compresie **BG** Комплект за измерване на компресия



300 mm
 150 mm



x3	20 BAR	300 PSI	PETROL
----	--------	---------	--------

HT8G411	1	20
---------	---	----

DE Zylinderlecktester **EN** Cylinder leak tester **FR** Testeur de fuites de cylindres **ES** Tester de estanqueidad de cilindros **HR** Ispitivač curenja cilindra **HU** Hengerfej diagnosztika készlet **RO** Tester de etanșare a cilindrului **BG** Тестер за цилиндри



7 BAR 100 PSI	480 mm	M12-M14	PETROL
------------------	--------	---------	--------

HT8G413	1	5
---------	---	---

DE Kraftstoffeinspritzdruckprüfgerät **EN** Fuel injection pressure tester **FR** Testeur l'injection de carburant sous pression **ES** Tester de presión de combustible de inyectores **HR** Komplet ispitivača za tlak goriva **HU** Üzemanyag nyomásmérő befecskendezéssel **RO** Tester de presiune a combustibilului cu injecție **BG** Тестер на горивният инжекцион



10 BAR 140 PSI	PETROL	K-JETRONIC SIS	KE-JETRONIC KIC	L-JETRONIC LW
-------------------	--------	-------------------	--------------------	------------------

HT8G415	1	5
---------	---	---

DE Prüfgerät für common Rail Rücklaufmengen **EN** Diagnostic kit for common rail injectors **FR** Kit de diagnostic pour injecteurs Common Rail **ES** Kit de diagnóstico para inyectores common rail **HR** Dijagnostički komplet za ubrizgače Common Rail **HU** Diagnosztikai készlet common rail injektorokhoz **RO** Set de diagnostic pentru injectoare common rail **BG** Комплект за тестване на дюзи Common rail



x31	DIESEL	6 CYLINDER	DELPHI	BOSCH	SIEMENS	DENSO
-----	--------	------------	--------	-------	---------	-------

HT8G418	1	5
---------	---	---



DE Refraktometer EN Refractometer FR Réfractomètre ES Refractómetro HR Refraktometar HU Refraktométer RO Refractometru BG Професионален рефрактометър



HT8G419	1	25

DE Drehwinkelmesser EN Torque angle gauge FR Rapporteur pour resserrer les boulons ES Transportador para apretar tornillos HR Kutomjer za zatezanje vijaka HU Nyomaték szögmérő RO Unghiul de cuplu BG Ъгломер за притягане



HT8G421	1/2"	12	48

DE Ringpresse EN Piston ring compressor FR Compresseur de segments de piston ES Abrazadera de anillos HR Crimper za prstenove HU Csavaros rögzítőbilincs RO Compresor inel piston BG Скоба за монтаж на бутала



SK5

HT8G423	50-125	75 mm	1	50
HT8G424	90-175	100 mm	1	50
HT8G425	90-175	150 mm	1	50

DE Farbdickenmessgerät EN Paint thickness tester FR Mesureur d'épaisseur de peinture ES Medidor de espesor de pintura HR Mjerač debljine laka na vozilu HU Festékbevonat vastagságmérő RO Calibru grosime acoperire vopsea BG Тестер на граповостта на повърхности



HT8G427	1	80

DE Werkzeugsatz für Lichtmaschinen mit Kupplung EN Alternator set with clutch FR Set pour alternateurs à embrayage ES Juego para alternadores con embrague HR Komplet za alternatore s kvačilom HU Kuplung generátor készlet RO Set alternatoare ambreiaj BG Комплект за ремонт на алтернатори

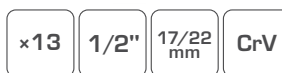

HT8G420	1/2"	1	10

DE Dichtungsabzieher EN Seal puller FR Extracteur des joints ES Extractor de juntas HR Izvlakač za brtve HU Tömítőhúzó RO Extractor sigiliu BG Инструмент за вадене на семеринги и уплътнения

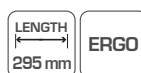

HT8G422	295 mm	9	36

DE Abklemmzangen EN Flexible line clamp FR Pincas de serrage tuyaux ES Pinzas prensa para mangueras HR Stezaljke crijeva HU Rögzítő fogó RO Clema flexibila de linie BG Комплект щипки за блокиране на гъвкави проводници



Ø 6,3-19 mm (1/4"-3/4")
Ø 12,5-32 mm (1/2"-5/4")
Ø 19-57 mm (3/4"-9/4")



HT8G426	1	50

DE Kabelklemmen EN Cable clamps FR Pincas d'obturation pour tuyaux et raccords banjos ES Abrazaderas para cables HR Set krokodil stezaljki HU Csőszorító készlet RO Bride de cablu BG Комплект херметични електрически конектори



HT8G428	8 - 13 mm	1	10

DE Berührungsloses Infrarot-Thermometer EN Non contact infrared thermometer
FR Thermomètre sans contact ES Termómetro sin contacto HR Beskontaktni termometar
HU Érintés nélküli hőmérő RO Termometru fără contact BG Безконтактен термометър

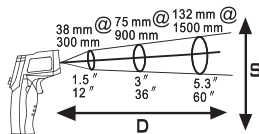

D:S
=12:1

-50°C
+550°C

HT8G429	1	50

DE Gluhkerzentester EN Glow plug analyser FR Testeur de bougie de préchauffage
ES Probador de bujías incandescentes HR Ispitivač žarnice HU Izzítógyertya-tesztelő
RO Tester bujie incandescenta BG Тестер на подревните свещи



12 V DIESEL

HT8G430	1	50

DE Zündfunkenprüfgerät EN Spark indicztor FR Testeur d'étincelles d'allumage
ES Probador de chispa de encendido HR Ispitivač svječica za paljenje HU Gyújtási szikra tesztelő
RO Tester cu scântei de aprindere BG Тестер за запалителната система



12 V for SPARK

HT8G431	50	500

DE Injektionsprüfgerät EN Injector tester FR Testeur d'injection ES Probador de inyección
HR Ispitivač ubrizgavanja HU Injekciós tesztelő RO Tester de injecție BG Тестер за инжектиране



12 V PETROL

HT8G432	1	24

DE Bremsflüssigkeits-Tester EN Brake fluid tester FR Testeur de liquide de frein
ES Comprobador de líquido de frenos HR Ispitivač kočione tekućine HU Fékfolyadék-tesztelő
RO Tester de lichid de frână BG Тестер за спирачна течност



DOT 3/4/5 9V

HT8G433	1	56

DE Bremsflüssigkeitstester manuell EN Brake fluid tester FR Testeur de liquide de frein manuel
ES Comprobador de líquido de frenos manual HR Ispitivač tekućine za ručnu kočnicu
HU Kézi fékfolyadék-tesztelő RO Tester manual de lichid de frana
BG Тестер за спирачна течност ръчен



DOT 3/4/5

HT8G434	1	60

DE Auto Strommesser EN Car current tester FR Courantomètre automobile ES Medidor de corriente para automóviles
HR Brojilo struje automobila HU Autó árammérő RO Contor de curent auto BG Автомобилен токомер



12 V MTA

HT8G435	1	60

DE Klemmen für Metallkabel EN Fluid lock set FR Pincés pour câbles métalliques
ES Abrazaderas para cables metálicos HR Svorky pro kovové kabely HU Bilincsek fém kábelekhöz
RO Cleme pentru cabluri metalice BG Комплект щипки за блокиране на метални кабели



x3 Al 4.2-10 mm

HT8G436	12	48

DE Magnetische Schutzmatte EN Magnetic protection matt FR Tapis de protection magnétique ES Alfombrilla protectora magnética HR Magnetska zaštitna prostirka HU Mágneses védőszőnyeg RO Cover de protecție magnetică BG Магнитна работна подложка



PP	MAGNETIC				
HT8G437	590 x 790 mm	1	40		

DE Blechschmiedeset EN A tinsmith set FR Ensemble ES Conjunto para chapista HR Limarski set HU Bádogos készlet RO Set siguranțe auto BG Комплект тенекеджийски чукове и наковални



x7	T x1	T x1	T x1	I x4	DROP FORGED			
HT8G460	1	4						

DE Autosicherungen EN Piece car fuse set FR Fusibles automobile ES Juego de fusibles para automóvil HR Set osigurača za automobile 120 kom. HU autóbiztosíték készlet RO siguranțe auto BG Комплект авто предпазители



5 A	10 A	15 A
20 pcs	20 pcs	20 pcs
20 A	25 A	30 A
20 pcs	20 pcs	20 pcs

x120	Zn/Al	Standard			
HT8G500	105 x 210 mm	5	20		

DE Schrumpfschläuche-Set 127 Stk. EN Piece heat shrink sleeve set FR Coffret de gaines thermorétractables ES Conjunto de fundas termorretráctiles HR Set termoskupljajućih bužira HU zsugorcső készlet RO manson termocontractabil BG Комплект термосвиваеми ръкави



2.0x40 mm	2.5x40 mm	3.5x40 mm
30 pcs	25 pcs	20 pcs
5.0x40 mm	7.0x80 mm	10.0x80 mm
20 pcs	16 pcs	8 pcs
13.0x85 mm		
8 pcs		

x127	125°C	max 600V			
HT8G501	105 x 210 mm	5	20		

DE Außen-Sicherungsringe-Set EN Piece external snap ring set FR Jeu de circlips type extérieur ES Juego de anillos de retención externos HR Set vanjskih zaustavnih prstena HU külső rögzítőgyűrű készlet RO inele de fixare externă BG Комплект външни блокиращи пръстени/скоби



3 mm	6 mm	13 mm	14 mm	16 mm	20 mm
10 pcs	12 pcs	12 pcs	7 pcs	10 pcs	8 pcs
4 mm	8 mm	32 mm	28 mm	27 mm	25 mm
5 pcs	8 pcs	3 pcs	5 pcs	8 pcs	7 pcs
5 mm	10 mm	11 mm	12 mm	19 mm	22 mm
7 pcs	10 pcs	7 pcs	8 pcs	13 pcs	10 pcs

x150	STEEL	65 Mn	OUTSIDE		
HT8G502	105 x 210 mm	5	20		

DE Set mit Innen- und Außen-Sicherungsringen EN Piece inner and external snap ring set FR Jeu de circlips intérieurs et extérieurs ES Juego de anillos de retención externos e internos HR Set vanjskih i unutarnjih zaustavnih prstena HU belső és külső rögzítőgyűrű készlet RO inele de fixare internă și externă BG Комплект вътрешни блокиращи пръстени/скоби



13 mm	13 mm	14 mm	16 mm	19 mm	20 mm
10 pcs	15 pcs	15 pcs	15 pcs	15 pcs	10 pcs
14 mm	16 mm	19 mm	22 mm	25 mm	32 mm
10 pcs	15 pcs	10 pcs	10 pcs	10 pcs	5 pcs
11 mm	20 mm	11 mm	9 mm	8 mm	6 mm
15 pcs	10 pcs	15 pcs	15 pcs	15 pcs	15 pcs

x225	STEEL	65 Mn	OUTSIDE/INSIDE		
HT8G503	105 x 210 mm	5	20		

DE Set mit geraden Splinten EN Piece straight pin set FR Jeu de goupilles fendues ES Juego de pasadores rectos HR Set rascjepki HU egyenes csapszegecs szett RO pinii drepte BG Комплект прави щифтове



1.6 x 25 mm	2.4 x 25 mm	2.4 x 38 mm
150 pcs	150 pcs	100 pcs
3.2 x 30 mm	3.2 x 50 mm	4.0 x 64 mm
75 pcs	50 pcs	30 pcs

x555	STEEL				
HT8G504	105 x 210 mm	5	20		

DE Nietmuttern-Set EN Piece rivet nut set FR Jeu d'écrous à rivets ES Conjunto de tuercas remachables HR Set zakivnih matica HU szegecsanya készlet RO piulite de nit BG Компл



M3 x 9 mm	M4 x 11 mm	M5 x 13 mm
40 tlg/pcs	35 tlg/pcs	25 tlg/pcs
M6 x 15 mm	M8 x 18 mm	M10 x 21 mm
25 tlg/pcs	15 tlg/pcs	10 tlg/pcs

x150	STEEL				
HT8G505	105 x 210 mm	5	20		

DE Klappsplint-Set mit Öse **EN** Piece split pin set **FR** Jeu de goupilles clips rondes **ES** Juego de pasadores con orejeta **HR** Set okruglih osigurača **HU** osztott csap készlet **RO** pini divizati **BG** Комплект кръгли клипсове



3/16" x 1 - 7/16" 16 pcs	1/4" x 1 - 3/4" 18 pcs
5/16" x 1 - 3/4" 6 pcs	7/16" x 1 - 3/4" 10 pcs

x50 **STEEL**

HT8G506	105 x 210 mm	1	20
---------	--------------	---	----

DE Gummidichtungen-Set **EN** Piece rubber gasket set **FR** Jeu de joints en caoutchouc **ES** Conjunto de juntas de goma **HR** Set gumenih brtvi **HU** Gumitömítés készlet **RO** Garnituri de cauciuc **BG** Комплект гумени уплътнения



Diameter	Thickness	pcs
5,29 mm	1,78 mm	20
6,07 mm	1,78 mm	20
6,80 mm	1,90 mm	20
7,65 mm	1,78 mm	20
7,80 mm	1,90 mm	20
8,00 mm	2,00 mm	20
8,80 mm	1,90 mm	20
10,82 mm	1,78 mm	15
10,77 mm	2,62 mm	15
11,00 mm	2,00 mm	15
12,00 mm	2,00 mm	15
13,90 mm	1,80 mm	10
13,95 mm	2,62 mm	10
10,00 mm	2,00 mm	10
15,00 mm	2,00 mm	10
17,00 mm	2,00 mm	10
17,70 mm	1,78 mm	10
17,04 mm	3,53 mm	10

x270 **NBR** **HEAT RESISTANT** **-50°C** **+125°C**

HT8G508	105 x 210 mm	5	20
---------	--------------	---	----

DE Hydraulikdichtungen-Set **EN** Piece hydraulic seal set **FR** Jeu de joints hydrauliques **ES** Conjunto de juntas hidráulicas **HR** Set hidrauličnih brtvi **HU** hidraulikus tömítő készlet **RO** garnituri hidraulice **BG** Комплект хидравлични уплътнения

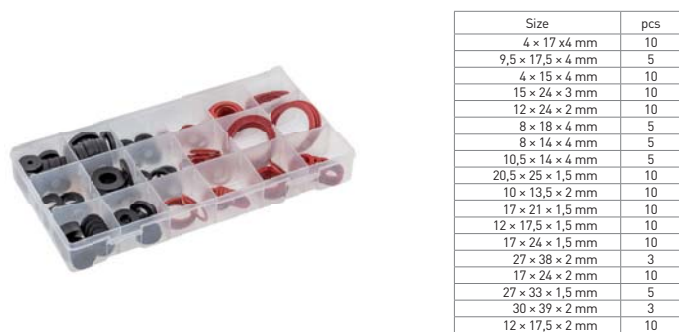

Size	pcs
4 x 17 x 4 mm	10
9,5 x 17,5 x 4 mm	5
4 x 15 x 4 mm	10
15 x 24 x 3 mm	10
12 x 24 x 2 mm	10
8 x 18 x 4 mm	5
8 x 14 x 4 mm	5
10,5 x 14 x 4 mm	5
20,5 x 25 x 1,5 mm	10
10 x 13,5 x 2 mm	10
17 x 21 x 1,5 mm	10
12 x 17,5 x 1,5 mm	10
17 x 24 x 1,5 mm	10
27 x 38 x 2 mm	3
17 x 24 x 2 mm	10
27 x 33 x 1,5 mm	5
30 x 39 x 2 mm	3
12 x 17,5 x 2 mm	10

x141 **RUBBER/CARDBOARD**

HT8G510	105 x 210 mm	5	20
---------	--------------	---	----

DE Schlauchschellen-Set **EN** Piece worm clamps set **FR** Jeu de colliers à vis sans fin **ES** Juego de abrazaderas de manguera **HR** Set obujmica **HU** csavaros bilincs készlet **RO** cleme tip vierme **BG** Комплект скоби за маркучи



Size	pcs
1/2"	5
5/8"	7
3/4"	10
7/8"	4
1"	3
1 1/6"	3
1 3/8"	4
1 1/2"	4

x40 **STEEL**

HT8G512	105 x 210 mm	5	20
---------	--------------	---	----

DE Gummidichtungen-Set **EN** Piece rubber gasket set **FR** Jeu de joints en caoutchouc **ES** Conjunto de juntas de goma **HR** Set gumenih brtvi **HU** gumitömítés készlet **RO** garnituri de cauciuc **BG** Комплект гумени уплътнения



Size	Diameter mm	Ø mm	pcs	Size	Diameter mm	Ø mm	pcs
R01	3,00	1,50	20	R17	20,00	3,50	10
R02	4,40	2,00	20	R18	22,00	3,50	10
R03	5,00	2,00	18	R19	23,50	3,50	10
R04	7,00	1,50	23	R20	25,00	3,50	10
R05	10,00	1,50	23	R21	25,50	3,50	10
R06	13,00	1,50	23	R22	28,00	3,50	10
R07	10,00	2,50	14	R23	30,00	3,50	10
R08	11,00	2,50	13	R24	31,00	3,50	10
R09	13,00	2,50	14	R25	33,00	3,60	10
R10	14,00	2,50	13	R26	34,50	3,50	10
R11	16,00	2,50	14	R27	35,00	3,50	10
R12	18,00	2,50	14	R28	35,00	3,50	10
R13	19,00	2,50	14	R29	41,00	3,50	10
R14	21,00	2,50	14	R30	44,00	3,50	10
R15	22,00	2,50	13	R31	47,00	3,50	10
R16	18,00	3,50	10	R32	50,00	3,50	10

x418 **NBR** **HEAT RESISTANT** **-50°C** **+125°C**

HT8G507	3,00-50,00 mm	1	20
---------	---------------	---	----

DE Gummidichtungen-Set **EN** Piece rubber gasket set **FR** Jeu de joints en caoutchouc **ES** Conjunto de juntas de goma **HR** Set gumenih brtvi **HU** gumitömítés készlet **RO** garnituri de cauciuc **BG** Комплект гумени уплътнения



Diameter	Thickness	pcs
3,00 mm	1,00 mm	20
4,00 mm	1,00 mm	20
4,50 mm	2,00 mm	20
5,00 mm	2,00 mm	20
6,00 mm	2,00 mm	20
6,00 mm	2,50 mm	20
6,00 mm	3,00 mm	20
7,00 mm	2,00 mm	20
8,00 mm	2,00 mm	20
9,00 mm	2,00 mm	5
10,00 mm	2,00 mm	5
12,00 mm	3,00 mm	5
13,00 mm	3,00 mm	5
14,00 mm	2,50 mm	5
17,00 mm	2,50 mm	5
18,00 mm	4,00 mm	5
20,00 mm	2,00 mm	5
22,00 mm	2,00 mm	5

x225 **NBR** **HEAT RESISTANT** **OIL, PETROL, CHEMICAL RESISTANT** **-50°C** **+125°C**

HT8G509	105 x 210 mm	5	20
---------	--------------	---	----

DE Schmiernippel-Set **EN** Piece grease fitting set **FR** Jeu de graisseurs **ES** Surtido de engrasadores **HR** Set mazalica **HU** kenőzsírcsavar készlet **RO** accesorii pentru montare grasime **BG** Комплект дихтунги

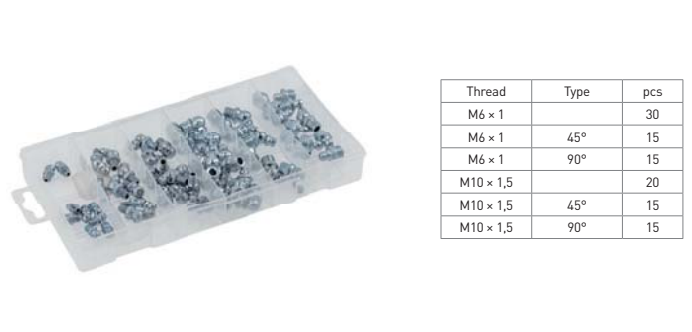

Thread	Type	pcs
M6 x 1		30
M6 x 1	45°	15
M6 x 1	90°	15
M10 x 1,5		20
M10 x 1,5	45°	15
M10 x 1,5	90°	15

x110 **STEEL**

HT8G511	105 x 210 mm	5	20
---------	--------------	---	----

DE Kupfer-Unterlegscheiben-Set **EN** Piece copper washer set **FR** Jeu de rondelles en cuivre **ES** Juego de arandelas de cobre **HR** Set bakrenih podložki **HU** réz alátét készlet **RO** garnituri de cupru **BG** Комплект медни шайби



Inner diameter	Outer diameter	Thickness	pcs
6,4 mm	13,6 mm	0,8 mm	30
7,9 mm	15,5 mm	1,5 mm	25
9,5 mm	15,5 mm	1,5 mm	20
11,1 mm	17,4 mm	1,5 mm	15
12,7 mm	18,6 mm	1,5 mm	10
15,9 mm	23,4 mm	1,5 mm	10

x110 **CU**

HT8G513	105 x 210 mm	5	20
---------	--------------	---	----

DE Feder-Set EN Piece spring set FR Coffret assortiment de ressorts ES Surtido de muelles HR Set opruga HU rugó készlet RO arcuri BG Комплект пружини



Diameter	Length	pcs
4 mm	79,5 mm	12
4,5 mm	44,5 mm	8
5 mm	20,5 mm	10
5,5 mm	25,5 mm	10
6,5 mm	22 mm	10
7 mm	38 mm	10
7 mm	51 mm	12
8 mm	28,5 mm	8
8 mm	44,5 mm	12
8,5 mm	36,5 mm	10
8,5 mm	47 mm	12
9,5 mm	17 mm	10
9,5 mm	38 mm	10
6,5 mm	10 mm	10
7 mm	12,5 mm	10
7 mm	19 mm	10
9 mm	35 mm	8
9,5 mm	16 mm	6
9,5 mm	19 mm	12

×200
←→ 124 SIZES
→← 76 SIZES
STEEL

HT8G514
105 x 210 mm
5
20

DE Feder-Splinte-Set EN Piece spring pin set FR Jeu de goupilles béta ES Conjunto de pasadores flexibles HR Set beta osigurača HU rugós csapszeg RO pini tip arc BG Комплект зегерки гъвкави



Diameter	Length	pcs
2 mm	33 mm	30
2 mm	40 mm	25
2,4 mm	31 mm	42
2,8 mm	42 mm	25
3,5 mm	45 mm	20
4 mm	75 mm	8

×150
STEEL

HT8G516
105 x 210 mm
5
20

DE Befestigungs Clip RENAULT EN Trim clips assortiment RENAULT FR Ensemble des clips de garniture RENAULT ES Conjunto de clips de recorte RENAULT HR Kopče za automobile RENAULT HU Rögzítő klipsz készlet RENAULT RO Set de fixare clip RENAULT BG Практичен комплект авто клипсове (щипки) за кори RENAULT



×300
for RENAULT
8 TYPES

HT8G550
270 x 170 mm
1
25

DE Befestigungs Clip FIAT EN Trim clips assortiment FIAT FR Ensemble des clips de garniture FIAT ES Conjunto de clips de recorte FIAT HR Kopče za automobile FIAT HU Rögzítő klipsz készlet FIAT RO Set de fixare clip FIAT BG Практичен комплект авто клипсове (щипки) за кори FIAT



×308
for FIAT
12 TYPES

HT8G552
270 x 170 mm
1
25

DE „E“-Splinte-Set EN Piece E-clip pin set FR Jeu d'anneaux Truarac type « E » ES Juego de pasadores tipo „E“ HR Set „E“ uskočnika HU E-Clip (hasított csap) készlet RO pini tip E BG Комплект зегерки тип E



Inner diameter	pcs
1,5 mm	30
3 mm	30
5 mm	40
6 mm	50
10 mm	50
12 mm	40
15 mm	20
19 mm	20
22 mm	20

×300
STEEL MN65
TYPE E

HT8G515
105 x 210 mm
5
20

DE Steckverbinder-Set EN Piece electrical clip set FR Jeu de pinces crocodiles ES Juego de conectores eléctricos HR Set električnih konektora HU elektromos csatlakozó készlet RO clipsuri electrice BG Комплект херметични електрически конектори



Clip type	Length	pcs
Uninsulated	50 mm	10
Insulated	50 mm	6
Insulated	70 mm	2
Insulated	75 mm	2
Insulated	35 mm	6
Insulated	45 mm	2

×28

HT8G517
105 x 210 mm
5
20

DE Befestigungs Clip PEUGOT EN Trim clips assortiment PEUGEOT FR Ensemble des clips de garniture PEUGOT ES Conjunto de clips de recorte PEUGOT HR Kopče za automobile PEUGOT HU Rögzítő klipsz készlet PEUGOT RO Set de fixare clip PEUGOT BG Практичен комплект авто клипсове (щипки) за кори PEUGEOT



×345
for PEUGOT
12 TYPES

HT8G551
270 x 170 mm
1
25

DE Befestigungs Clip VOLVO EN Trim clips assortiment VOLVO FR Ensemble des clips de garniture VOLVO ES Conjunto de clips de recorte VOLVO HR Kopče za automobile VOLVO HU Rögzítő klipsz készlet VOLVO RO Set de fixare clip VOLVO BG Практичен комплект авто клипсове (щипки) за кори VOLVO



×350
for VOLVO
12 TYPES

HT8G553
270 x 170 mm
1
25

DE Befestigungs Clip TOYOTA, LEXUS **EN** Trim clips assortment TOYOTA, LEXUS **FR** Ensemble des clips de garniture TOYOTA, LEXUS **ES** Conjunto de clips de recorte TOYOTA, LEXUS **HR** Kopče za automobile TOYOTA, LEXUS **HU** Rögzítő klipsz készlet TOYOTA, LEXUS **RO** Set de fixare clip TOYOTA, LEXUS **BG** Практичен комплект авто клипсове (щипки) за кори TOYOTA, LEXUS



x360 for VOLVO/LEXUS **18** TYPES

HT8G554	270 x 170 mm	1	25

DE Befestigungs Clip HONDA **EN** Trim clips assortment HONDA **FR** Ensemble des clips de garniture HONDA **ES** Conjunto de clips de recorte HONDA **HR** Kopče za automobile HONDA **HU** Rögzítő klipsz készlet HONDA **RO** Set de fixare clip HONDA **BG** Практичен комплект авто клипсове (щипки) за кори HONDA



x418 for HONDA **18** TYPES

HT8G555	270 x 170 mm	1	25

DE Befestigungs Clip MAZDA **EN** Trim clips assortment MAZDA **FR** Ensemble des clips de garniture MAZDA **ES** Conjunto de clips de recorte MAZDA **HR** Kopče za automobile MAZDA **HU** Rögzítő klipsz készlet MAZDA **RO** Set de fixare clip MAZDA **BG** Практичен комплект авто клипсове (щипки) за кори MAZDA



x475 for MAZDA **18** TYPES

HT8G556	270 x 170 mm	1	25

DE Befestigungs Clip OPEL **EN** Trim clips assortment OPEL **FR** Ensemble des clips de garniture OPEL **ES** Conjunto de clips de recorte OPEL **HR** Kopče za automobile OPEL **HU** Rögzítő klipsz készlet OPEL **RO** Set de fixare clip OPEL **BG** Практичен комплект авто клипсове (щипки) за кори OPEL



x300 for OPEL **6** TYPES

HT8G557	270 x 170 mm	1	25

DE Befestigungs Clip FORD **EN** Trim clips assortment FORD **FR** Ensemble des clips de garniture FORD **ES** Conjunto de clips de recorte FORD **HR** Kopče za automobile FORD **HU** Rögzítő klipsz készlet FORD **RO** Set de fixare clip FORD **BG** Практичен комплект авто клипсове (щипки) за кори FORD



x415 for FORD **18** TYPES

HT8G558	270 x 170 mm	1	25

DE Befestigungs Clip BMW **EN** Trim clips assortment BMW **FR** Ensemble des clips de garniture BMW **ES** Conjunto de clips de recorte BMW **HR** Kopče za automobile BMW **HU** Rögzítő klipsz készlet BMW **RO** Set de fixare clip BMW **BG** Практичен комплект авто клипсове (щипки) за кори BMW



x290 for BMW **6** TYPES

HT8G559	270 x 170 mm	1	25

DE Befestigungs Clip VW **EN** Trim clips assortment VW **FR** Ensemble des clips de garniture VW **ES** Conjunto de clips de recorte VW **HR** Kopče za automobile VW **HU** Rögzítő klipsz készlet VW **RO** Set de fixare clip VW **BG** Практичен комплект авто клипсове (щипки) за кори VW



x255 for VW **12** TYPES

HT8G560	270 x 170 mm	1	25

DE Befestigungs Clip AUDI **EN** Trim clips assortment AUDI **FR** Ensemble des clips de garniture AUDI **ES** Conjunto de clips de recorte AUDI **HR** Kopče za automobile AUDI **HU** Rögzítő klipsz készlet AUDI **RO** Set de fixare clip AUDI **BG** Практичен комплект авто клипсове (щипки) за кори AUDI



x160 for AUDI **12** TYPES

HT8G561	270 x 170 mm	1	25

DE Anlasserkabe EN Jumper cables FR Câbles de démarrage ES Cables de arranque
HR Kabel za pokretanje HU Indító kábel RO Cablu de pornire BG Кабели за стартов ток



	□	m	A	cm ³	▢	▣
HT8G601		3	400	1400	1	20
HT8G602		3,5	600	2000	1	20

Cu/Al

DE Elektronisches Ladegerät EN Automatic battery charger FR Cargador de batería automático ES Chargeur de batterie automatique HR Automatski punjač akumulatora
HU Akkumulátor töltő RO Incarcator electric BG Зарядно за акумулатор



230V ~50Hz	max 6V/12V	max 140Ah	STANDARD GEL/AGM
---------------	---------------	--------------	---------------------

□	A	▢	▣
HT8G610	2 A / 4 A	1	20

DE Elektronisches Ladegerät EN Automatic battery charger FR Cargador de batería automático ES Chargeur de batterie automatique HR Automatski punjač akumulatora
HU Akkumulátor töltő RO Incarcator electric BG Зарядно за акумулатор

DE Elektronisches Ladegerät EN Automatic battery charger FR Cargador de batería automático ES Chargeur de batterie automatique HR Automatski punjač akumulatora
HU Akkumulátor töltő RO Incarcator electric BG Зарядно за акумулатор



max 7A	max 6V/12V	max 105 Ah	standard
230V ~50Hz	4A/7A	2 m	

□	▢	▣	▤
HT8G611	max 7 A	1	4



12 V	2A/ 8A/ 15A	WET/ GEL/ AGM/ Ca-Ca	AUTO
15-300 Ah	9 STEPS	Desulfator/ Conditioner	IP 20

□	▢	▣
HT8G613	1	8

DE Elektronisches Ladegerät EN Automatic battery charger FR Cargador de batería automático ES Chargeur de batterie automatique HR Automatski punjač akumulatora
HU Akkumulátor töltő RO Incarcator electric BG Зарядно за акумулатор

DE Elektronisches Ladegerät EN Automatic battery charger FR Cargador de batería automático ES Chargeur de batterie automatique HR Automatski punjač akumulatora
HU Akkumulátor töltő RO Incarcator electric BG Зарядно за акумулатор



MAX 6V/12V	MAX 12A	WET	AUTO	20-200 Ah	IP 20
---------------	------------	-----	------	--------------	-------

□	▢	▣
HT8G614	1	5



MAX 12V/24V	14A/ 26A	WET	AUTO
40-350 Ah	IP 20	BOOSTER	

□	▢	▣
HT8G616	1	2

DE Digitales Batterieprüfgerät EN Digital battery tester FR Testeur de batterie numérique ES Comprobador de batería digital HR Digitalni ispitivač baterija HU Digitális akkumulátor tesztelő RO Tester digital de baterii BG тестер за акумулатори

DE Fettpresse EN Grease gun FR Pistolet à graisse à poignée pistolet ES Pistola de engrasar HR Mast pištolj HU Zsírzóprés RO Pistol de unsoare BG Ръчен такалит



12 V	100 A	LED LIGHT
------	-------	--------------

□	▢	▣
HT8G620	1	10



400 ml	4500-6000 PSI 310-415 BAR	400 g	1,2 cm ³	x4
--------	------------------------------------	-------	---------------------	----

□	▢	▣
HT8G904	1	10



CHARGING CURRENT

CE EAC

HÖGERT

HT86616

HÖGERT PRIORITÄT IP20
120 - 240 Ah
INPUT / WEIßSCHE OUTPUT / WYŚCIE
12V 5A 12V 5A 24V 5A 24V 30A

AC. INPUT

230V/50Hz

HÖGERT Technik

DE Fettpresse EN Grease gun FR Pistolet à graisse à poignée pistolet ES Pistola de engrasar HR Mast pištolj HU Zsírózóprés RO Pistol de unsoare BG Ръчен такаламит



400 cm ³	400 g	max 8000 psi/ 550 bar	x4
M10 x1.0	AI	1,2 cm ³	

HT8G905	1	10

DE Fettpresse EN Grease gun FR Pistolet à graisse à poignée pistolet ES Pistola de engrasar HR Mast pištolj HU Zsírózóprés RO Pistol de unsoare BG Ръчен такаламит



600 ml	6000-8000 PSI 400-550 BAR	2,4 cm ³	300mm	x4
--------	---------------------------	---------------------	-------	----

HT8G907	1	10

DE Fettpresse EN Grease gun FR Pistolet à graisse à poignée pistolet ES Pistola de engrasar HR Mast pištolj HU Zsírózóprés RO Pistol de unsoare BG Ръчен такаламит



600 cm ³	x2	max 10000 psi/ 700 bar	x4
M10 x1.0	300mm	150 mm	2,4 cm ³

HT8G908	1	10

DE Fettpresse EN Grease gun FR Pistolet à graisse à poignée pistolet ES Pistola de engrasar HR Mast pištolj HU Zsírózóprés RO Pistol de unsoare BG Ръчен такаламит



6 l	3600 PSI 250 BAR	1.8 m	3 cm ³
-----	------------------	-------	-------------------

HT8G912	1	1

DE Fettpresse EN Grease gun FR Pistolet à graisse à poignée pistolet ES Pistola de engrasar HR Mast pištolj HU Zsírózóprés RO Pistol de unsoare BG Ръчен такаламит



16 l	max 2600 PSI 180 BAR	1.8 m	3 cm ³
------	----------------------	-------	-------------------

HT8G913	1	1

DE Pneumatischer Fettpresse EN Pneumatic grease gun FR Graiseur pneumatique ES Lubricador neumático HR Pneumatska mazalica HU Pneumatikus kenőanyag adagoló RO Pistol de gresat pneumatic BG Ръчен такаламит пневматичен



400 ml	90 PSI/ 6 BAR	113 l/min	1/4"
--------	---------------	-----------	------

HT4R790	1	10

DE Pneumatischer Fettpresse EN Pneumatic grease gun FR Graiseur pneumatique ES Lubricador neumático HR Pneumatska mazalica HU Pneumatikus kenőanyag adagoló RO Pistol de gresat pneumatic BG Ръчен такаламит пневматичен



12 l	4350-5800 PSI 300-400 BAR	87-116 PSI 6-8 BAR	0.85 l/min	50:1
------	---------------------------	--------------------	------------	------

HT4R795	1	1

DE 4 Backen Mundstück für Fettpresse EN Grease coupler FR Coupleur à graisse ES Boquilla para engrasadora de 4 garras HR Vrh s 4 čeljusti HU Zsírózó csatlakozó RO Cuplaj pentru aparat de ungere BG Накрайник 4-челюстен



x4	x2	37 mm	M10 x 1
----	----	-------	---------

HT8G915	37 mm	50	100

DE Schlauch für Fettpresse EN Grease gun hose FR Tuyau de pistolet à graisse
 ES Manguera para engrasadora HR Crijevo za podmazivač HU Zsírozó pisztoly tömlő
 RO Furtun pentru aparat de ungere BG Маркуч за шприц за масло



M10 x 1	max 10150 PSI 700 BAR	Ø 8 mm	LENGTH 300 mm				
HT8G920	8 x 300 mm	10	100				

DE Ölspritzkanne Plastik EN Plastic pressure oil can FR Huile de pression de métal
 ES Aceitera de plástico HR Podmazivač od plastike HU Műanyag olajozó kanna
 RO Dispozitiv de ulei din plastic BG Масльонка пластмасова



250 ml	PLASTIC						
HT8G925	10	60					

DE Ölspritzkanne Metall EN Metal pressure oil can FR Huile de pression de métal
 ES Aceitera de metal HR Metalni podmazivač HU Fém olajozó kanna RO Dispozitiv de ulei din metal BG Масльонка метална



200 ml	METAL						
HT8G930	10	60					

DE Öl Absaugpumpe EN Oil suction gun FR Pistolet d'aspiration d'huile ES Pistola de succión, agujeros de inspección en el cuerpo HR Usisavač HU Szívó fecskendő
 RO Seringa de aspiratie BG Шприц за масло



500 ml	280 mm						
HT8G935	1	20					

DE Öl Absaugpumpe EN Oil suction gun FR Pistolet d'aspiration d'huile ES Pistola de succión HR Usisavač HU Szívó fecskendő RO Seringa de aspiratie BG Шприц за масло



500 ml	280 mm						
HT8G936	1	20					

DE Flüssigkeitsspender EN Vacuum pump FR Distributeur de liquide ES Dispensador de líquido HR Dozator za tekućinu HU Folyadékadagoló RO Dozator lichid BG Туба за индустриални течности



350 ml	OIL	DIESEL	WATER	ADBLUE			
HT8G937	1	10					

DE Handpumpe EN Hand pump for barrel FR Pompe à main ES Bomba de mano HR Ručna pumpa HU Kézi pumpa RO Pompa manuala BG Вложки за картерни пробки



200 ml	Al	16-18 l/min	45-90 cm				
0,25 l	BARREL SIZE 50, 60, 200 l	WATER	OILS				
HT8G940	1	10					

DE Zweiteiliger Trichter EN Two-piece funnel FR Entonnoir carburant avec flexible ES Embudo de dos piezas HR Lijevak od dva dijela HU Kétrészes tölcser RO Pâlnie din două piese BG Фуния от две части



145 mm	LENGTH 390 mm						
HT8G945	145 x 390 mm	1	100				

DE Trichter für Betriebsflüssigkeiten EN Long neck funnel FR Entonnoir pour fluides de service ES Embudo para fluidos operativos HR Lijevak za radne tekućine HU Töltésér az üzemfolyadékokhoz RO Pâlnie pentru fluidele de operare BG Фуния за експлоатационни течности



∅ 115 mm	PP	LENGTH 460 mm	1.1 l
-------------	----	------------------	-------

HT8G946	1	50

DE Ölablass EN Oil drain pan FR Vidange d'huile ES Escurridor de aceite HR Odvod za ulje HU olajleeresztő RO Scurgător de ulei BG Тава за масло



	10l	HDPE
13 cm		

HT8G947	1	50



DE Werkstattwerkzeuge
EN Workshop Tools
FR Outillage D'atelier
ES Herramientas De Taller
HR Alati Za Radionice
HU Műhelyszerszámok
RO Scule De Atelier
BG Работни Инструменти





HÖGERT
TECHNIK

DE Werkstattlampe EN Work light torch FR Torche d'inspection ES Linterna para inspección HR Inspeksijska svjetiljka HU Ellenőrző zseblámpa RO Lanternă de inspecție BG Инспекционен фенер



COB 3W	LED 3W	ABS	MAGNETIC
18m	16m	AAA 1.5V x3	

HT1E402	160 lm	12	96

DE Werkstattlampe EN Work light torch FR Torche d'inspection ES Linterna para inspección HR Inspeksijska svjetiljka HU Ellenőrző zseblámpa RO Lanternă de inspecție BG Инспекционен фенер



COB 3W	LED 3W	1200mAh	3.7V 1200mAh	ROTATED HOOK
MAGNETIC	USB	ABS	-2,5h	

HT1E406	160 lm	50	100

DE Werkstattlampe EN Workshop lamp FR Torche d'inspection ES Linterna para inspección HR Inspeksijska svjetiljka HU Műhelylámpa RO Lampă de atelier BG Работна лампа



5W COB	+2-3W LED	3.7V 2000mAh	POWER BANK function with USB	IP54
LIGHT CONTROL	max 2-2,5h	3h	2x MAGNETIC	HOOK

HT1E407	400 lm + 200 lm	25	50

DE Werkstattlampe EN Workshop lamp FR Torche d'inspection ES Linterna para inspección HR Inspeksijska svjetiljka HU Műhelylámpa RO Lampă de atelier BG Работна лампа



10W COB	+5W LED	3.7V 2000mAh	POWER BANK function with USB	IP54
max 3-3,5h	2,5h	Direct USB & charging base	2x MAGNETIC	ROTATED HOOK

HT1E408	400 lm + 250 lm	10	20

DE Werkstattlampe EN Workshop lamp FR Torche d'inspection ES Linterna para inspección HR Inspeksijska svjetiljka HU Műhelylámpa RO Lampă de atelier BG Работна лампа



10W COB	3.7V 2000mAh	IP54	LIGHT CONTROL	max 2-2,5h
3h	direct USB	MAGNETIC	HOOK	

HT1E409	400 lm	25	50

DE Led Werkstattlampe EN Workshop lamp FR Portable LED Lampe ES Lámpara portátil HR Prijenosna rasvjeta HU Hordozható lámpatest RO Corp de iluminat portabil BG Преносимо осветително тяло



LED technology	inside	A+ A	5W	6400K
AC 100-250V/50-60 Hz	IP 54	H05RN-F 2x1.00 mm ²	PF>0.5	40 000h
ON OFF x20 000	5m	ABS	HOOK	20m

HT1E410	350 lm	1	40

DE Stirnlampe EN Headlamp FR Lampe frontale ES Linterna para casco de seguridad HR Čeona svjetiljka HU Homloklámpa RO Lanternă frontală BG Челник



LED technology	IP 20	LED 3W	ABS		10m
AAA 1.5V x3	NOT INCLUDED	40 000h	3 modes 100% 50% S.O.S.	6400K	A+ A

HT1E420	160 lm	12	48

DE Taschenlampe EN Pocket flashlight FR Lampe de poche ES Linterna de bolsillo HR Džepna svjetiljka HU Kézilámpa RO Lanternă BG Фенер



LED technology	IP 20	5W	AI	6400K	
200m	AA/14500 (3.7V) x1	NOT INCLUDED	40 000h	A+ A	S.O.S. ZOOM

HT1E424	250 lm	20	80

DE Taschenlampe **EN** Pocket flashlight **FR** Lampe de poche **ES** Linterna de bolsillo **HR** Džepna svjetiljka **HU** Kézilámpa **RO** Lanternă **BG** Фенер



10W	Li-Ion 3.7V 4000mAh	IP54	max 5-5.5 h	Alu Alloy
ZOOM	4 modes 100%, 50%, S.O.S., Flashing	4 h	direct USB	



HT1E425	800 lm	20	40

DE Teleskop inspektionsspiegel **EN** Inspection mirror **FR** Miroir d'inspection **ES** Espejo de inspección **HR** Okruglo inspeksijsko ogledalo **HU** Ellenőrző tükör **RO** Oglindă de inspecție **BG** Инспекционно огледало



 Ø52 mm	 TELESCOPIC max 715 mm	 ERGO GRIP
------------	---------------------------------	--------------------------

HT4R502	52 mm	715 mm	12	72

DE Magnetheber **EN** Magnetic pick up tool **FR** Outil magnétique **ES** Extractor de imán **HR** Teleskopski magnetski držač **HU** Mágneses felszedő **RO** Suport magnetic **BG** Магнитен държач за инструменти



 TELESCOPIC max 640 mm	 MAGNETIC	 2.7 kg max
---------------------------------	--------------	-------------------

HT4R506	135-640 mm	12	72

DE Magnetheber **EN** Magnetic pick up tool **FR** Outil magnétique **ES** Extractor de imán **HR** Magnetski držač **HU** Mágneses felszedő **RO** Suport magnetic **BG** Магнитен държач за инструменти



 510 mm	 FLEXIBLE	 1 kg max
------------	--------------	-----------------

HT4R509	510 mm	12	120

DE Akku strahler **EN** Floodlight **FR** Torche d'inspection **ES** Linterna para inspección **HR** Inspeksijska svjetiljka **HU** Megvilágító **RO** Proiector **BG** Прожектор

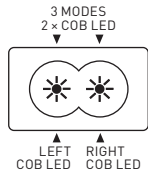

 2x10 W COB	Li-Ion 3.7V 4400mAh	POWER BANK function with USB	IP 54	3 MODES
max 4-5.5h	4 h	HANDLE & STAND	 TPR PROTECTION	direct USB

HT1E430	1150 lm	1	20

DE Teleskop inspektionsspiegel **EN** Inspection mirror **FR** Miroir d'inspection **ES** Espejo de inspección **HR** Pravokutno inspeksijsko ogledalo **HU** Ellenőrző tükör **RO** Oglindă de inspecție **BG** Инспекционно огледало



 50x80 mm	 TELESCOPIC max 880 mm	 ERGO GRIP	 LR 44 x 3	 LED technology
-----------------	---------------------------------	--------------------------	---------------	------------------------------

HT4R504	300-880 mm	12	72

DE Magnetheber **EN** Magnetic pick up tool **FR** Outil magnétique **ES** Extractor de imán **HR** Magnetski držač **HU** Mágneses felszedő **RO** Suport magnetic **BG** Магнитен държач за инструменти



 TELESCOPIC max 810 mm	 MAGNETIC	 3.6 kg max
 ERGO GRIP	 LR 44 x 3	 LED technology

HT4R508	195-810 mm	12	72

DE Magnetheber **EN** Magnetic pick up tool **FR** Outil magnétique avec pince **ES** Extractor de imán **HR** Magnetski držač **HU** Megfogószerkezet **RO** Dispozitiv de arucare **BG** Ваштач



 620 mm	 FLEXIBLE	 1 kg max
 CHUCK & LED	 LR 44 x 3	 LED technology

HT4R510	610 mm	12	72

DE Magnetschale EN Magnetic tray FR Plateau magnétique ES Plato magnético HR Magnetska zdjela HU Mágneses csavargyűjtő tálca RO Bol magnetic BG Магнитна купа



150 mm	MAGNETIC	25 mm	INOX	HT4R512	∅ 150 mm	25 mm	1 36

DE Magnetwerkzeughalter EN Magnetic tool holder FR Porte-outil magnétique ES Listón magnético HR Magnetska letva HU Mágneses szerszámtartó RO Bandă magnetică BG Магнитна лента



460 mm	MAGNETIC	13 kg MAX	STEEL	HT4R520	460 mm	4	16

DE Magnet für schlagschrauber EN Magnetic holder FR Support magnétique pour clé à chocs et douilles ES Soporte magnético HR Magnetni držač za pneumatski ključ HU Mágneses felszedő RO Suport magnetic BG Магнитен държач за инструменти



MAGNETIC	5,9 kg	STEEL/PVC	4x	HT4R518	1	10

DE Magnet Werkzeughalter mit schale Satz EN Magnetic holder set FR Barres magnétiques et bac de rangement ES Portaherramientas magnético HR Magnetne letve i posudica, 3 kom. HU Mágneses lécek és dob RO Benzi și bol magnetic BG Ленти и магнитна купа



MAGNETIC	x3	10 kg	HT4R522	460 mm (19 x 395 mm) 23,8 x 13,8 x 20 mm	1	5

DE Magnetwerkzeughalter EN Magnetic holder set FR Porte-outil magnétique ES Listón magnético HR Magnetne letve, 3 kom. HU Mágneses szerszámtartó RO Bandă magnetică BG Магнитна лента



MAGNETIC	10 kg	x3	STEEL	HT4R521	200 mm (19 x 150 mm) 300 mm (19 x 248 mm) 460 mm (19 x 395 mm)	6	12

DE Magnet für schlagschrauber EN Magnetic holder FR Support magnétique pour clé à chocs et douilles ES Soporte magnético HR Magnetni držač HU Mágneses felszedő RO Suport magnetic BG Магнитен държач за инструменти



MAGNETIC	1,4 kg	STEEL/PVC	40 mm	HT4R519	6	48



HÖGERT
technik

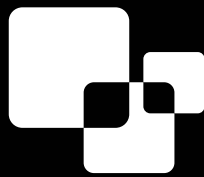

DE Werkzeuge Für Elektriker

EN Tools For Electricians

FR Outils Pour Electriciens

ES Herramientas Para Electricistas

HR Alati Za Električare

HU Villanyszerelési Szerszámok

RO Instrumente Pentru Electricieni

BG Инструменти За Елетротехници



HÖGERT

HT1E604

AUTO
APO
0000 mV

TRUE-RMS MULTIMETER
6000 COUNTS

AUTO POWER OFF

Select

Range

Relative

Max/Min

Hz/Duty

Ω \pm Hz Duty $^{\circ}C/^{\circ}F$ hFE

OFF V_{\sim} V_{\sim} μA_{\sim} mA_{\sim} A_{\sim} \square OFF

CE
EN 61010-1
CAT III 600V
CAT II 1000V

10A

μA mA

COM

INPUT

FUSED
10A MAX
10SEC MAX
EACH 15MIN

FUS
40
MA

600V
MAX



DE Universell digital Messgerät EN Universal digital meter FR Multimètre numérique ES Multímetro digital universal HR Višenamjenski mjerac sa zaslonom HU Digitális multiméter RO Multimetru digital BG Мултицет дигитален



HT1E602	160 x 75 x 30 mm	1	50
---------	------------------	---	----

AUTO-RANGE	U.D.C. 600V U.A.C. 600V	I.D.C. 10A
R 2MΩ	DATA HOLD	
LED DIODE	1999 DISPLAY	BATTERY 1,5 / 9V



DE Universell digital Messgerät EN Universal digital meter FR Multimètre numérique ES Multímetro digital universal HR Višenamjenski mjerac sa zaslonom HU Digitális multiméter RO Multimetru digital BG Мултицет дигитален



HT1E603	160 x 75 x 30 mm	1	50
---------	------------------	---	----

AUTO-RANGE	TRUE RMS	U.D.C. 600V U.A.C. 600V	I.D.C. 10A I.A.C. 10A
R 40 MΩ	-20°C ~1000°C	5-5 MHz	DATA HOLD
RELATIVE		3999 DISPLAY	



DE Universelles digitales Messgerät FULL-SMART EN Universal digital meter FULL-SMART FR Multimètre numérique avec technologie FULL-SMART ES Medidor digital universal FULL-SMART HR FULL-SMART digitalni mjerac HU FULL-SMART digitális multiméter RO FULL-SMART multimetru digital BG Мултицет дигитален универсален FULL SMART

HT1E605	121 x 60 x 36 mm	1	50
---------	------------------	---	----

NCV	TRUE RMS	SMART	U.D.C. 600V U.A.C. 600V
I.D.C. 10A I.A.C. 10A	R 60MΩ	C 60mF	20 MHz
DATA HOLD	6000 DISPLAY		

DE Universelles digitales Messgerät FULL-SMART EN Universal digital meter FULL-SMART FR Multimètre numérique universel FULL-SMART ES Medidor digital universal FULL-SMART HR FULL-SMART digitalni mjerac HU FULL-SMART digitális multiméter RO FULL-SMART multimetru digital BG Мултицет дигитален универсален FULL SMART

HT1E615	204 x 39 x 30 mm	1	100
---------	------------------	---	-----

NCV	TRUE RMS	SMART	U.D.C. 600V U.A.C. 600V
R 40 MΩ	C 40mF	4 MHz	DATA HOLD
4000 DISPLAY			



DE Universell digital Messgerät EN Universal digital meter FR Multimètre numérique ES Multímetro digital universal HR Višenamjenski mjerac sa zaslonom HU Digitális multiméter RO Multimetru digital BG Мултицет дигитален



HT1E600	150 x 70 x 50 mm	1	40
---------	------------------	---	----

NCV	TRUE RMS	AUTO-RANGE	U.D.C. 600V U.A.C. 600V
I.D.C. 10A I.A.C. 10A	R 99,99MΩ	C 99,99mF	BATTERY 1,5 / 9V
DATA HOLD	VFC	LED DIODE	9999 DISPLAY

DE Universell digital Messgerät EN Universal digital meter FR Multimètre numérique ES Multímetro digital universal HR Višenamjenski mjerac sa zaslonom HU Digitális multiméter RO Multimetru digital BG Мултицет дигитален

HT1E601	150 x 70 x 50 mm	1	40
---------	------------------	---	----

NCV	TRUE RMS	SMART U.A.C./DC	AUTO-RANGE
U.D.C. 600V U.A.C. 600V	I.D.C. 10A I.A.C. 10A	R 99,99MΩ	C 10 mF
BATTERY 1,5 / 9V	DATA HOLD	LED DIODE	9999 DISPLAY



DE Universell digital Messgerät EN Universal digital meter FR Multimètre numérique ES Multímetro digital universal HR Višenamjenski mjerac sa zaslonom HU Digitális multiméter RO Multimetru digital BG Мултицет дигитален



HT1E606	1	40
---------	---	----

SELECT	4000 DISPLAY	U.D.C. 2000V U.A.C. 2000V	I.D.C. 400 mA I.A.C. 400 mA
R 400MΩ	C 400 uF	-40°C ~1000°C -4°F ~1832°F	4MHz
hFE PNP NPN	DATA HOLD		



DE Universell digital Messgerät EN Universal digital meter FR Multimètre numérique ES Multímetro digital universal HR Višenamjenski mjerac sa zaslonom HU Digitális multiméter RO Multimetru digital BG Мултицет дигитален

HT1E604	190 x 90 x 40 mm	1	20
---------	------------------	---	----

TRUE RMS	AUTO-RANGE	SELECT	RANGE
RELATIVE	U.D.C. 600V U.A.C. 600V	I.D.C. 10A I.A.C. 10A	R 60MΩ
C 60mF	-20°C ~1000°C	0-10 MHz	DATA HOLD
MIN/MAX		5999 DISPLAY	



DE Universell Klemme Messgerät EN Universal clamp meter FR Pince ampèremétrique ES Multimetro pinza universal HR Mjerna kliješta HU Univerzális lakatfogó multiméter RO Clampmetru digital BG Ампер клещи дигитални

NCV	TRUE RMS	AUTO-RANGE	U.D.C. 600V
I.A.C. 600A	R 60MΩ	DATA HOLD	VFC
Low Z			

HT1E620	1	20

DE Universal clamp meter EN Universell Klemme Messgerät FR Pince ampère-métrique ES Multimetro pinza universal HR Mjerna kliješta HU Univerzális lakatfogó multiméter RO Clampmetru digital BG Ампер клещи дигитални

NCV	TRUE RMS	AUTO-RANGE	U.D.C. 600V	I.A.C. 600A
R 60MΩ	MAX Ø20 mm	DATA HOLD	MIN/MAX	SELECT
	RANGE			5999 DISPLAY

HT1E621	1	20

DE Kabel Verfolger EN Cable tracker FR Détecteur de câbles ES Trazador de cable HR Detektor kablova HU Vezeték detektor RO Detector de cabluri BG Цифров детектор



NCV	RJ11 RJ45	
-----	-----------	--

HT1E640	RJ11, RJ45	1	40

DE Spannungsprüfer EN Voltage tester FR Testeur de tension ES Medidor de voltaje HR Električni tester HU Fázisceruza RO Surubelnite de tensiune BG Фазомер



	AC 100-500V	140 mm
--	-------------	--------

HT1S982	140 mm	30	600



DE Spannungsprüfer EN Voltage tester FR Testeur de tension ES Medidor de voltaje HR Električni tester HU Fázisceruza RO Surubelnite de tensiune BG Фазомер



	AC 100-500V	150 mm
--	-------------	--------

HT1S981	150 mm	12	240

DE Spannungsprüfer EN Induction voltage tester FR Testeur de tension par induction ES Probador De Voltaje Eléctrico HR Beskontaktni ispitivač napona HU Induktív feszültségvizsgáló RO Tester de tensiune inductiva BG Детектор на напрежение

	NCV	12-1000V	48-1000V
	LED	ON/OFF	

HT1E630	12-1000 V 48-1000 V	1	120

DE Kombinationszange 1000 V EN Insulated combination pliers 1000 V FR Pince combinée isolée 1000 V ES Alicates universales 1000 V HR Univerzalna kliješta 1000 V HU Kombinált fogó 1000 V RO Cleste combinat 1000 V BG Клещи комбинирани 1000V



VDE 1000V	CrV	HRC 55-60	DIN 5749
-----------	-----	-----------	----------

HT1P903	160 mm	6	60
HT1P905	180 mm	6	60
HT1P907	200 mm	6	60

DE Seitenschneider 1000 V EN Insulated diagonal side cutters 1000 V FR Coupe-bordures diagonales isolées 1000 V ES Alicates de corte 1000 V HR Bočna kliješta 1000 V HU Oldalsípő fogók 1000 V RO Cleste cu taietura laterala 1000 V BG Клещи резачки 1000V



VDE 1000V	CrV	HRC 55-60	DIN 5749	HIGH LEVERAGE
-----------	-----	-----------	----------	---------------

HT1P909	160 mm	6	60
HT1P911	180 mm	6	60

DE Verlängerte Zange 1000 V EN Elongated, straight pliers 1000 V FR Pince à becs droits 1000 V ES Alicates alargados rectos 1000 V HR Izdužena ravna kliješta 1000 V HU Rádiós fogó 1000 V RO Cleste cu varf lung 1000 V BG Клещи плоскоустни удължени 1000V



VDE 1000V	CrV	HRC 55-60	DIN 5745	PTFE COAT
-----------	-----	-----------	----------	-----------

HT1P913	160 mm	6	60
HT1P917	200 mm	6	60

DE Verlängerte Zange gewinkelt 1000V EN Elongated, bent pliers 1000V FR Pince à becs courbés 1000 V ES Alicates alargados curvos 1000 V HR Izdužena zakrivljena kliješta 1000 V HU Hajlított rádiós fogó 1000 V RO Cleste cu varf lung, curb, 1000 V BG Клещи тип "човки" удължени 1000V



VDE 1000V	CrV	HRC 55-60	DIN 5745	PTFE COAT
-----------	-----	-----------	----------	-----------

HT1P919	160 mm	6	60
HT1P923	200 mm	6	60

DE Abisolierzange 1000 V EN Wire stripper pliers 1000 V FR Pince à dénuder isolée 1000 V ES Alicates pelacables 1000 V HR Kliješta za skidanje izolacije 1000 V HU Vezeték csupaszoló fogó 1000 V RO Cleste de dezizolare 1000 V BG Клещи за сваляне на изолация 1000V



VDE 1000V	CrV	HRC 55-60	DIN 5745	PTFE COAT
-----------	-----	-----------	----------	-----------

HT1P931	160 mm	6	60

DE Abisoliermesser, zum Abmanteln aller gängigen EN Cable stripper FR Couteau à dénager ES Alicata Pelacables HR Alat za skidanje izolacije s oštricom HU Vezeték csupaszoló RO Dispozitiv dezizolat BG Нож за кабели и изолация



∅ 8-28 mm	ADJUSTABLE	ERGO GRIP
-----------	------------	-----------

HT1P189	170 mm	∅ 8-28 mm	12 48

DE Kabelschere EN Electrician's shears FR Ciseaux pour électricien ES Tijera Electricista HR Škare za rezanje žica i izolacije HU Villanyzerelő olló RO Foarfeca pentru taiat cablu BG Ножици за рязане на кабели и изолация



CUT COPPER ~0,5mm	48-52 HRC	CUTTING NOTCH	SS	ERGO GRIP
-------------------	-----------	---------------	----	-----------

HT1P040	140 mm	10	120

DE Kraft-Seitenschneider EN Cable cutter pliers FR Pince coupante de câble ES Alicates cortacables HR Kliješta za rezanje žica i kablova HU Vezetékvágó fogók RO Cleste pentru taiat cablu BG Клещи за рязане на кабели



2.5-8.0 mm ²	14-8 AWG	max 12 mm
-------------------------	----------	-----------

Al Cu	SK5
-------	-----

HT1P047	170 mm	2,5 - 8,0 mm ² (14-8 AWG)	10 60

DE Kabelzange EN Cable cutting pliers FR Pince coupe-câble ES Alicates cortacables HR Kliješta za rezanje kablova HU Vezetékvágó fogók RO Cleste pentru taiat cablu BG Клещи за рязане на кабели



∅ max 10.5 mm	Al Cu	STRIPPING KNIFE
LOCK	SK5	ERGO GRIP

HT1P046	168 mm	∅ 10,5 mm	10 60

DE Kabelzange EN Cable cutting pliers FR Pince coupante pour câble ES Alicates cortacables HR Kliješta za rezanje kablova HU Vezetékvágó fogók RO Cleste pentru taiat cablu BG Клещи за рязане на кабели



Al Cu	CrV	ERGO GRIP
-------	-----	-----------

HT1P042	160 mm	3 mm	6 60
HT1P044	200 mm	11 mm	6 60

DE Kabelschneider EN Cable Cutter FR Coupe-câble ES Cortador de cables HR Škare za kablove HU Vezetékvágó RO Cleste pentru taiat cablu cu maner lung BG Ножици за рязане на кабели



CrV Al Cu
MAX Ø22 mm MAX Ø26 mm ERGO GRIP

HT1P048	450 mm		1	12
HT1P049	600 mm		1	12

DE Kable Abisolierer EN Wire stripper FR Pince à dénuder ES Pelacables HR Alat za skidanje izolacije HU Csúszóló RO Dispozitiv dezizolat BG Нож за заголване на изолация



0,5-5,0 mm² 20-10 AWG 8-13 mm²
RG 6 RG 59 SK5

HT1P102	122 mm	0,5 - 6,0 mm ² (AWG 20-10)	15	90

DE Kable Abisolierer EN Wire stripper FR Pince à dénuder ES Pelacables HR Alat za skidanje izolacije HU Csúszóló RO Dispozitiv dezizolat BG Нож за заголване на изолация



4P 6P 8P RG 6 RG 59
TRISSET 113 Profi 11 SK5

HT1P103	125 mm	RG-6, RG-59, Triset-113, Triset Profi, Triset-11	10	50

DE Abisolierzange für Lichtfaser Leitungen EN Fibre optic wire stripper FR Pince à dénuder fibre optique ES Alicate Pelacables fibra óptica HR Klijesta za skidanje izolacije sa svijetlovodnih kabela HU Optikai kábel csúszóló RO Cleste dezizolator pentru cabluri cu fibre optice BG Клещи за рязане и заголване на оптични кабели



FOR FIBRE OPTIC WIRE µm 250 µm 600-900
HIGH PRECISION ERGO GRIP

HT1P186	145 mm	2,8-3,0 mm and 2,0-3,0 mm	10	60

DE Automatische Abisolierzange EN Automatic wire stripper FR Pince automatique à dénuder ES Alicate Pelacables automático HR Automatski alat za skidanje izolacije HU Automata vezetékcúszóló RO Cleste de dezizolat automat BG Автоматични клещи за рязане и заголване на оптични кабели



0,2-6,0 mm² 24-10 AWG SK5 ERGO GRIP

HT1P187	180 x 170 x 32 mm	0,2 - 6,0 mm ² (24-10 AWG)	10	60

DE Automatische Abisolierzange EN Automatic wire stripper FR Pince automatique à dénuder ES Alicate Pelacables automático HR Automatski alat za skidanje izolacije HU Automata vezetékcúszóló RO Cleste de dezizolat automat BG Автоматични клещи за рязане и заголване на оптични кабели



1,0-3,2 mm² 18-12 AWG SK5 ERGO GRIP

HT1P188	168 mm	1,0-3,2 mm ² (18-12 AWG)	8	48

DE Automatische Abisolierzange EN Automatic wire stripper FR Pince à dénuder automatique ES Alicate Pelacables automático HR Automatska klijesta za skidanje izolacije HU Automata vezetékcúszóló RO Cleste dezizolator automat BG Автоматични клещи за рязане и заголване на оптични кабели



0,2-6,0 mm² 24-10 AWG CR12MoV STEEL BLADES
HIGH PRECISION ERGO GRIP

HT1P181	205 mm	0,2-6,0 mm ² (24-10 AWG)	10	40

DE Automatische Abisolierzange EN Automatic wire stripper FR Pince à dénuder automatique ES Alicate Pelacables automático HR Automatska klijesta za skidanje izolacije HU Automata vezetékcúszóló RO Cleste dezizolator automat BG Автоматични клещи за рязане и заголване на оптични кабели



0,05-10 mm² 30-8 AWG CUTTER SK5 STRIPPER SK5
HIGH PRECISION ERGO GRIP

HT1P182	210 mm	0,05 to 10,0 mm ² (30-8 AWG)	10	60

DE Crimp-Hebelzange für Westernstecker **EN** Telephone connector crimping plier **FR** Pince à sertir pour téléphone **ES** Tenazas crimpadoras para cables de telefonía **HR** Kliješta za prešanje za telefonske i računalne stezaljke **HU** Telefon és internet csatlakozó prés **RO** Cleste de sertizat pentru conector telefonice si informatice **BG** Клещи за кримпване на телефонни букси



RJ10	RJ11	RJ12	RJ45	4P
6P	8P	10P	CUTTER	

HT1P170	200 mm	4P, 6P, 8P, 10P	10	40
---------	--------	-----------------	----	----

DE Crimpzange für Telefonstecker **EN** Telephone connector crimping plier **FR** Outil de sertissage de connecteur téléphone **ES** Tenazas crimpadoras para conectores de telefonía **HR** Alat za prešanje telefonskih i računalnih stezaljki **HU** Telefon csatlakozó prés **RO** Cleste de sertizat pentru conector telefonice **BG** Клещи за кримпване на телефонни букси



6P	8P	RJ45	CUTTER SK5
HIGH PRECISION	EASY CRIMPING	ERGO GRIP	

HT1P172	137 mm	6P, 8P, RJ45	8	48
---------	--------	--------------	---	----

DE Crimpzange, Set mit 6 wechselbaren Einsätzen **EN** Crimping plier interchangeable **FR** Pince à sertir interchangeable **ES** Tenaza crimpadora con mordazas intercambiables **HR** Kliješta za stezanje sa izmenljivim čeljustima **HU** Cserélhető betétes prészerszám **RO** Cleste de sertizat cu falci interschimbabile **BG** Комплект кримпващи клещи с части



- A 0.5 - 6 mm² (22 - 10 AWG)
- A1 0.5 - 10 mm² (22 - 8 AWG)
- A2 0.5 - 6 mm² (22 - 10 AWG)
- A3 0.1 - 1.5 mm² (26 - 16 AWG)
- A4 0.5 - 2.5 mm² (22 - 14 AWG)
- A5 0.5 - 6 mm² (22 - 10 AWG)

×7	QUICK EXCHANGE	RATCHET	ERGO GRIP
----	----------------	---------	-----------

HT1P176	220 mm	1	10
---------	--------	---	----

DE Crimpzange für unisolierte Schiebekabelschuhe **EN** Non-insulated terminal crimping plier **FR** Pince à sertir **ES** Tenaza crimpadora para terminales no aislados **HR** Kliješta za stezanje neizoliranih, kliznih stezaljki **HU** Szigetetlen csúsós sáru prés **RO** Cleste de sertizat pentru conector telefonice **BG** Клещи за кримпване на неизолирани кабелни обувки



1.5 - 6.0 mm ²	16 - 10 AWG	RATCHET	
---------------------------	-------------	---------	--

HT1P192	220 mm	1.5 - 6.0 mm ² (16-10 AWG)	10	40
---------	--------	---------------------------------------	----	----

DE Crimpzange für Aderendhülsen **EN** Insulated terminal crimping pliers **FR** Pince à sertir isolée **ES** Tenaza crimpadora para terminales aislados **HR** Kliješta za stezanje izoliranih stezaljki **HU** Szigetelt sáru prés **RO** Cleste de sertizat **BG** Клещи за кримпване на изолирани кабелни обувки



0.5-2.5 mm ²	22-14 AWG	INSULATED	
ERGO GRIP	RATCHET		

HT1P160	191 mm	0.5 - 2.5 mm ² (22-14 AWG)	6	36
---------	--------	---------------------------------------	---	----

DE Crimpzange für isolierte Kabelschuhe **EN** Insulated terminal crimping plier **FR** Pince à sertir isolée **ES** Tenaza crimpadora aislada **HR** Kliješta za stezanje izoliranih stezaljki **HU** Szigetelt szemes sáru prés **RO** Cleste de sertizat **BG** Клещи за кримпване на изолирани кабелни обувки



0.5 - 6.0 mm ²	20 - 10 AWG	RATCHET	
---------------------------	-------------	---------	--

HT1P194	220 mm	0.5 - 6.0 mm ² (20-10 AWG)	10	40
---------	--------	---------------------------------------	----	----

DE Crimpzange für dünnwandige Kabelschuhe **EN** Cord end terminal crimping pliers **FR** Pince à sertir idéale pour des travaux de telecommunications **ES** Tenaza crimpadora para cables terminal **HR** Kliješta za stezanje tankoslojnih čahura **HU** Érvégűvel prés **RO** Cleste de sertizat **BG** Клещи за кримпване втулковни накрайници



0.5 - 6.0 mm ²	20 - 10 AWG	RATCHET	
---------------------------	-------------	---------	--

HT1P195	220 mm	0.5 - 6.0 mm ² (20-10 AWG)	10	40
---------	--------	---------------------------------------	----	----

DE Crimpzange für dünnwandige Kabelschuhe **EN** Cord end terminal crimping pliers **FR** Pince à sertir idéale pour des travaux de telecommunications **ES** Tenaza crimpadora para cables terminal **HR** Kliješta za stezanje tankoslojnih čahura **HU** Érvégűvel prés **RO** Cleste de sertizat **BG** Клещи за кримпване втулковни накрайници



0.5-4.0 mm ²	22-12 AWG	CORD END	ERGO GRIP	RATCHET
-------------------------	-----------	----------	-----------	---------

HT1P161	191 mm	0.5-4.0 mm ² (22-12 AWG)	6	36
---------	--------	-------------------------------------	---	----

DE Presszange für dünnwandige Hülsen EN Cord end terminal crimping pliers
FR Pince à sertir idéale pour des travaux de télécommunications ES Tenaza crimpadora para cables terminal HR Klijesta za stezanje tankoslojnih čahura HU Érvéghüvely prés RO Cleste de sertizat BG Клещи за кримпване втулкови накрайници





6-16 mm ²	10-6 AWG	CORD END	HT1P162	191 mm	6 - 16,0 mm ² (10-6 AWG)	6	36

DE Crimpzange, selbsteinstellend EN Ferrule crimper wire plier FR Pince à sertir auto-réglable ES Tenaza crimpadora autoajustable HR Samopodesiva klijesta za stezanje tankoslojnih čahura HU Érvéghüvely krimpelő prés RO Cleste de sertizat BG Клещи за кримпване втулкови накрайници





0.25-6.0 mm ²	23-10 AWG	RATCHET	HT1P190	175 mm	0,25 - 6,0 mm ² (23-10 AWG)	10	40

DE Crimpzange für KOAX-Kabelschuhe EN Coaxial connector terminal crimping pliers FR Pince à sertir coaxial ES Crimpadora cable coaxial HR Klijesta za stezanje stezaljki HU Koax csatlakozó prés RO Cleste de sertizat pentru conector coaxial BG Клещи за кримпване тип коак





HEX: 1/1.7/4.5/6.5/7 mm	RATCHET	HT1P196	230 mm	1, 1.7, 4.5, 6.5, 7 mm	10	40

DE Kompressionswerkzeug zum Verpressen EN Crimping pliers for connectors FR Pince à sertir pour connecteur ES Alicata para conectores HR Klijesta za stezanje konektora HU MC4 csatlakozó préserszám RO Cleste de sertizat pentru conector tip BG Клещи за кримпване на MC4 конектори





2.5/4.0/6.0 mm ²	MC4	RATCHET	HT1P199	270 mm	2.5, 4.0 and 6.0 mm ²	10	20

DE Crimpzange für unisolierte Kabelschuhe EN Non-insulated terminal crimping plier FR Pince à sertir non isolée idéale pour des travaux de télécommunications ES Tenaza crimpadora para terminales no aislados HR Klijesta za stezanje neizoliranih stezaljki HU Szigeteletlen szemes saru prés RO Cleste de sertizat BG Клещи за кримпване на неизолирани кабелни обувки





1.0-10 mm ²	20-8 AWG	RATCHET	HT1P193	220 mm	1,0 - 10,0 mm ² (20-8 AWG)	10	40

DE Crimpzange, selbsteinstellend EN Ferrule crimper wire plier FR Pince à sertir auto-réglable ES Tenaza crimpadora autoajustable HR Samopodesiva klijesta za stezanje tankoslojnih čahura HU Érvéghüvely krimpelő prés RO Cleste de sertizat BG Клещи за кримпване втулкови накрайници



4-16 mm ²	6-12 AWG	RATCHET	HT1P191	210 mm	4 - 16 mm ² (6-12 AWG)	10	40

DE Kompressionswerkzeug zum Verpressen EN Crimping pliers for connectors FR Pince à sertir coaxial ES Alicata para conectores HR Klijesta za stezanje koaksijalnih priključaka HU Prészerszám koaxiális csatlakozókhoz RO Cleste de sertizat pentru conector coaxial BG Клещи за кримпване конектори



A3 STEEL	ERGO GRIP	HT1P198	200 mm	RG-59, RG-6, Triset-113 & Triset Profi	10	40

DE Hydraulische Kabelcrimper EN Hydraulic manual crimping tool FR Sertisseuse hydraulique pour câbles ES Crimpadora hidráulica HR Hidraulična preša za kablove HU Hidraulikus kézi krimpelő eszköz RO Instrument de sertizare manual hidraulic BG Хидравлични клещи за кримпване на кабели



x12	100 kN	HT1P169	16-300 mm ²	1	1

DE Isolierband **EN** Insulation tape **FR** Ruban isolant **ES** Cinta aislante **HR** Izolacijska traka **HU** PVC szigetelőszalag **RO** Benzi izolatoare **BG** Изолационна лента



0,13x19 mm
20m
0,39 kV/mm
-20° +60°
125%
WATERPROOF
PVC

Code	Dimensions	Color	Quantity
HT1P281	0,13 mm × 19 mm × 20 m	Black	10 / 200
HT1P282	0,13 mm × 19 mm × 20 m	Red	
HT1P283	0,13 mm × 19 mm × 20 m	Blue	
HT1P284	0,13 mm × 19 mm × 20 m	Green	
HT1P285	0,13 mm × 19 mm × 20 m	White	
HT1P286	0,13 mm × 19 mm × 20 m	Yellow	

DE Verlängerungskabel mit Gummi-Isolierung **EN** Rubber Insulated Extension Cord **FR** Rallonge électrique en caoutchouc **ES** Prolongador de cable con aislamiento de goma **HR** Produžni kabel u gumenoj izolaciji **HU** Rubber Insulated Extension Cord **RO** Rubber Insulated Extension Cord **BG** Гумиран удължителен кабел



3x1,5 mm²
MAX 4000 W
HO5RR-F
IP44

Code	Dimensions	Length	Quantity
HT1E700	3 × 1,5 mm ²	10 m	1 / 4
HT1E701	3 × 1,5 mm ²	20 m	1 / 1
HT1E702	3 × 1,5 mm ²	30 m	1 / 2

DE Kabeltrommel mit Gummi-Isolierung **EN** Rubber Insulated Drum Extension Cord **FR** Rallonge sur tambour en caoutchouc **ES** Enrollables con cable con aislamiento de goma **HR** Gumeni produžni kabel na bubnju **HU** Szigetelt gumiköpenyes hosszabbító kábeldob **RO** Prelungitor cu izolare din cauciuc cu tambur **BG** Удължител макара гумиран кабел



3x1,5 mm²
MAX 3000 W
HO5RR-F
FRENCH
IP44

Code	Dimensions	Length	Quantity
HT1E720	3 × 1,5 mm ²	20 m	1 / 2
HT1E721	3 × 1,5 mm ²	30 m	1 / 2

DE Kabeltrommel mit Gummi-Isolierung **EN** Rubber Insulated Drum Extension Cord **FR** Rallonge sur tambour en caoutchouc **ES** Enrollables con cable con aislamiento de goma **HR** Gumeni produžni kabel na bubnju **HU** Szigetelt gumiköpenyes hosszabbító kábeldob **RO** Prelungitor cu izolare din cauciuc cu tambur **BG** Удължител макара гумиран кабел



3x2,5 mm²
MAX 3600 W
HO7RN-F
FRENCH
IP44

Code	Dimensions	Length	Quantity
HT1E735	3 × 2,5 mm ²	30 m	1 / 1



HÖGERT

20m
2x
1.5 mm²

IP44

www.hogert.com

IP44

IP44

ERL CE

HT16720

9 602817 9001 7

HÖGERT
technik

DE Werkzeuge Für Klempner
EN Tools For Plumbers
FR Outils Hydrauliques
ES Herramientas Para Fontaneros
HR Alati Za Vodoinstalatore
HU Gépészeti Szerszámok
RO Instrumente Pentru Instaltori
BG Инструменти За Водопроводчик



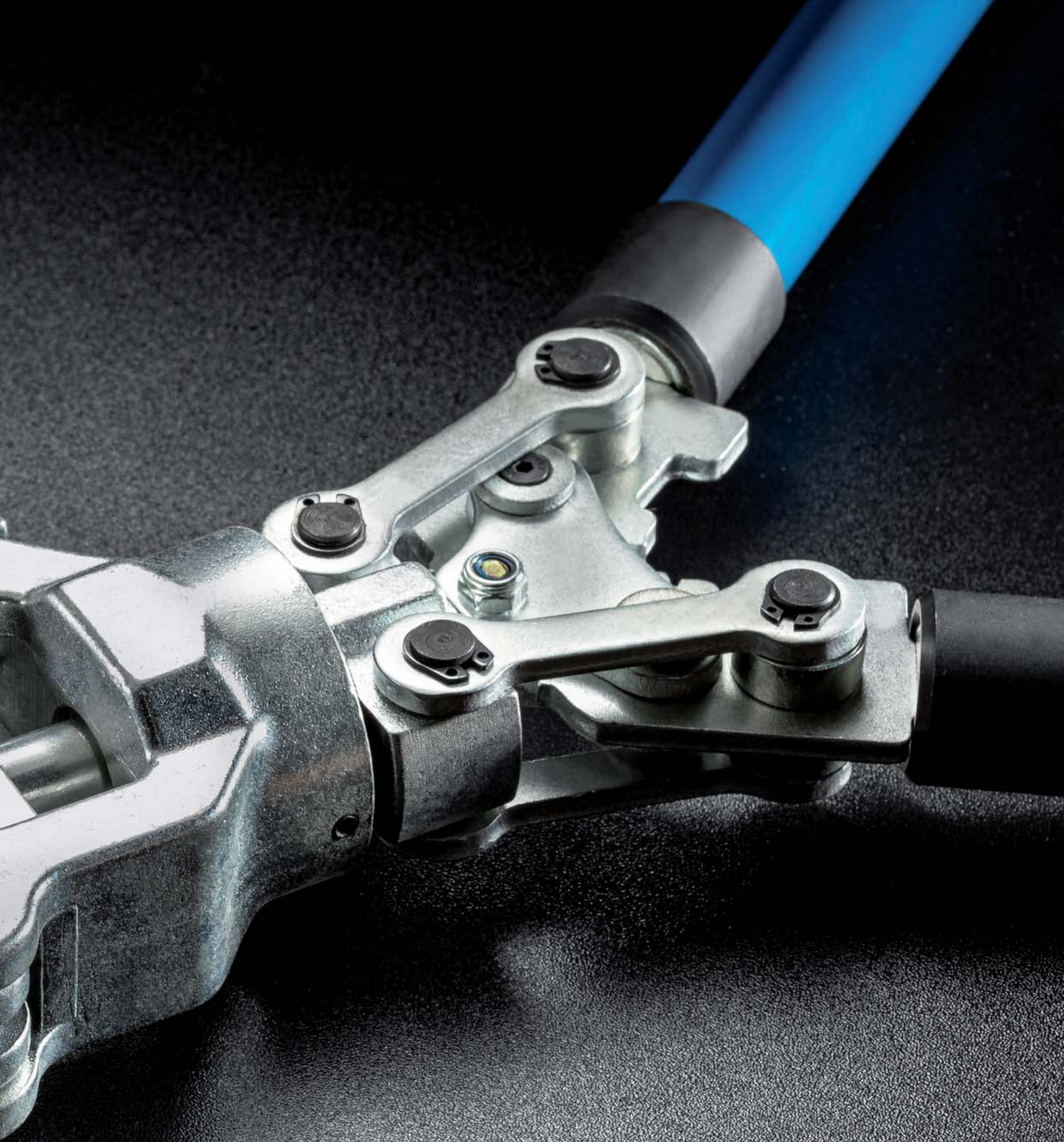

DE Wasserrohrzange EN Water pump pliers with spring release FR Pince pompe à eau à ressort ES Alicantes para tuberías HR Podesiva klijesta za cijevi HU Vízpumpa fogók RO Cleste tip papagal BG Клещи водопроводни тип "Гагра"



	Folder	Length	Ø max	Box	Box
HT1P375		250 mm	38 mm	6	60
HT1P376		300 mm	50 mm	6	36
HT1P377		400 mm	95 mm	4	24



DE Wasserrohrzange EN Water pump pliers FR Pince pompe à eau ES Alicates para tuberías HR Podesiva klijesta za cijevi HU Vízpumpa fogók RO Cleste tip papagal BG Клещи водопроводни



	Folder	Length	Ø max	Box	Box
HT1P372		250 mm	35 mm	6	60



DE Gripzange EN Locking pliers FR Pince-étou avec mâchoires courbées ES Alicate de presión con mandíbulas curvadas HR Grip klijesta - okrugle čeljusti HU Rögztő fogók - kerek pófával RO Cleste cu blocare - falci curbte BG Клещи чираци



	Folder	Length	Box	Box
HT1P382		250 mm	6	36



DE Verstellschlüssel EN Adjustable wrench FR Clé à molette Ergo Grip ES Llave ajustable Ergo Grip HR Podesivi ključ HU Állítható kulcs RO Chei reglabile BG Регулируем гаечен ключ



	Folder	Length	Ø max	Box	Box
HT1P501		1" - 320 mm	50 mm	1	24
HT1P502		1-1/2" - 430 mm	70 mm	1	18
HT1P503		2" - 560 mm	80 mm	1	10



DE Wasserrohrzange, selbsteinstellend EN Auto adjusting water pump pliers FR Pince pompe à eau ajustement automatique ES Alicates para tuberías autoajustables HR Samopodesiva klijesta za cijevi HU Auto adjusting water pump pliers RO Cleste tip papagal automat BG Клещи водопроводни тип "Гагра" с бутон



	Folder	Length	Ø max	Box	Box
HT1P378		250 mm	35 mm	6	60
HT1P379		300 mm	40 mm	6	36



DE Gripzange EN Locking pliers FR Pince-étou avec mâchoires courbées ES Alicate de presión con mandíbulas curvadas HR Grip klijesta - okrugle čeljusti HU Rögztő fogók - kerek pófával RO Cleste cu blocare - falci curbte BG Клещи чираци



	Folder	Length	Box	Box
HT1P380		250 mm	6	36



DE Gripzange EN Locking pliers FR Pince-étou avec mâchoires droites ES Alicate de presión con mandíbulas rectas largas HR Grip klijesta - izdužene, ravne čeljusti HU Rögztő fogók - hosszú, egyenes pófával RO Cleste cu blocare - falci lungi, drepte BG Клещи чираци



	Folder	Length	Box	Box
HT1P384		225 mm	6	36



DE Verstellschlüssel EN Adjustable wrench FR Clé à molette Ergo Grip ES Llave ajustable Ergo Grip HR Podesivi ključ HU Állítható kulcs RO Chei reglabile BG Регулируем гаечен ключ



	Folder	Length	Ø max	Box	Box
HT1P506		1" - 320 mm	50 mm	1	24
HT1P507		1-1/2" - 430 mm	70 mm	1	18
HT1P508		2" - 560 mm	80 mm	1	10



DE Rohrschlüssel, Typ "S" EN Pipe wrenches, S-Type FR Clé à pipe type S ES Llave de tubo tipo S HR Ključ za cijevi, tip S HU Cső fogó - S típusú RO Cleste suedez tip S BG Тръбен ключ тип "Гагра"



		Ø max		
HT1P519	0,5" - 240 mm	35 mm	1	48
HT1P520	1" - 320 mm	47 mm	1	24
HT1P522	1,5" - 430 mm	63 mm	1	18
HT1P524	2" - 560 mm	80 mm	1	10
HT1P526	3" - 640 mm	95 mm	1	6



DE Stillson Typ Rohrzanze EN Pipe wrench (stillson type) FR Clé serre-tube Stillson ES Llave de tubo tipo Stillson HR Ključ za cijevi, tip stillson HU Cső fogó, „Stillson” típus RO Cleste tip „Stillton” BG Тръбен ключ



		Ø max		
HT1P530	10" - 250 mm	34 mm	6	30
HT1P532	12" - 300 mm	42 mm	6	18
HT1P534	14" - 350 mm	50 mm	6	12
HT1P536	18" - 450 mm	60 mm	6	12



DE Rohrzanze EN Pipe wrench FR Clé serre-tube ES Llave de tubo HR Ključ za cijevi HU Cső fogó RO Cleste BG Тръбен ключ



		Ø max		
HT1P531	10" - 250 mm	50 mm	6	48
HT1P533	12" - 300 mm	70 mm	6	36
HT1P535	14" - 350 mm	80 mm	6	24
HT1P537	18" - 450 mm	90 mm	6	12
HT1P539	24" - 600 mm	100 mm	5	10



DE Rohrschlüssel EN Offset pipe wrench FR Clé à tube ES Llave de tubo HR Klještima HU Hajlított csőkulcs RO Cheie curbata pentru țevi BG Тръбен ключ огънат



		Ø max		
HT1P541	12" - 300 mm	70 mm	6	24
HT1P542	14" - 350 mm	80 mm	6	24
HT1P543	18" - 450 mm	90 mm	6	12



DE Rohrschlüssel EN Aluminium pipe wrench FR Clé à tube ES Llave de tubo HR Klještima HU Aluminium csőkulcs RO Cheie din aluminiu pentru țevi BG Алюминиев тръбен ключ



		Ø max		
HT1P545	14" - 350 mm	80 mm	6	24
HT1P546	18" - 450 mm	90 mm	6	12
HT1P547	24" - 600 mm	100 mm	5	10



DE Kettenschlüssel EN Chain key FR Clé à chaîne ES Llave de cadena HR Lančani ključ HU Láncos cső fogó RO Cheie cu lant BG Верижен тръбен ключ



		Ø max		
HT1P548	300 mm/12"	100 mm	6	24



DE Verstell Schlüssel EN Adjustable wrench FR Clé à molette Ergo Grip ES Llave ajustable Ergo Grip HR Podesivi ključ HU Állítható kulcs RO Chei reglabile BG Регулируем гаечен ключ



HT1P552	200 mm	25 mm	6	60
HT1P554	250 mm	30 mm	6	36
HT1P556	300 mm	36 mm	6	24



DE Verstell Schlüssel EN Adjustable wrench FR Clé à molette PRO Ergo Grip ES Llave ajustable Pro Ergo Grip HR Podesivi ključ HU Állítható kulcs RO Chei reglabile BG Регулируем гаечен ключ



HT1P560	250 mm	30 mm	6	36



DE Verstell Schlüssel EN Adjustable wrench FR Clé à molette ES Llave ajustable HR Oksidirani podesivi ključ HU Állítható oxidált kulcs RO Chei reglabile oxidate BG Регулируем гаечен ключ



CrV	LONG THIN JAW	SHORT HANDLE		HT1P561	165 mm	35 mm	6	60
				HT1P563	215 mm	40 mm	6	60

DE Verstell Schlüssel mit langem Griff EN Adjustable wrench FR Clé à molette à poignée longue ES Llave ajustable mango largo HR Podesivi ključ s dugom ručicom HU Állítható kulcs hosszú markolattal RO Chei reglabile cu maner lung BG Регулируем гаечен ключ



CrV	LONG THIN JAW	-30%	ERGO GRIP		HT1P564	256 mm	43 mm	6	36
-----	---------------	------	-----------	--	---------	--------	-------	---	----

DE Rohrschneider EN Tube cutter FR Coupe-tube ES Cortatubos hasta HR Rezač cijevi HU Csővágó RO Cutter pentru tevi BG Тръборез



Cu, Al, Steel		HSS	Ø 35mm	20-60 mm	HT1P600	1/2"-2"	1	10
---------------	--	-----	--------	----------	---------	---------	---	----

DE Klinge für Rohrschneider HT1P603 EN Blade for pipe cutter HT1P603 FR Lame pour coupe-tube HT1P603 ES Cuchilla para cortatubos HT1P603 HR Oštrica za rezač cijevi HT1P603 HU Csővágó RO Cutter pentru tevi BG Режещ ръб за тръборез



HRC 53	SK5	V SHAPE	HT1P617	max 42 mm	20	200
--------	-----	---------	---------	-----------	----	-----

DE Verstell Schlüssel mit kurzem Griff EN Adjustable wrench FR Clé à ouverture variable à manche courte ES Llave ajustable con mango corto HR Podesivi ključ s kratkom ručicom HU Állítható kulcs rövid markolattal RO Chei reglabile cu maner scurt BG Регулируем гаечен ключ



CrV	LONG THIN JAW	SHORT HANDLE	-30%	ERGO GRIP		HT1P562	140 mm	32 mm	6	72
-----	---------------	--------------	------	-----------	--	---------	--------	-------	---	----

DE Stufenschlüssel EN Step wrench FR Clé de montage étagée ES Llave escalonada HR Koraci ključ HU Lépcsős radiátorkulcs RO Cheie în trepte BG Универсална ключ-вложка

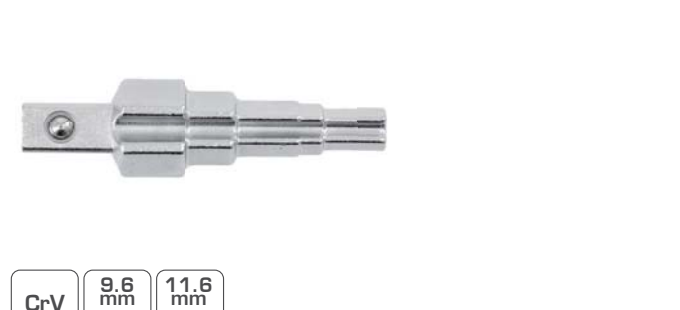

CrV	9.6 mm	11.6 mm	HT1P595	9.6 mm (3/8") - 21 mm (27/32")	1	100
	3/8"	29/68"				
12.6 mm	16.4 mm	21 mm				
1/2"	21/32"	27/32"				

DE Rohrschneider EN Tube cutter FR Coupe-tube ES Cortatubos HR Rezač cijevi HU Csővágó RO Cutter pentru tevi BG Тръборез



HRC 53	SK5	PVC	PP	HT1P603	max. 42 mm	10	50
PE	PEX	PP-R	PEX-AL				

DE Rohrschneider EN Tube cutter FR Coupe-tube pour le plastique ES Corta-tubos de tubos de plástico HR Rezač cijevi HU Műanyag és gépészeti csővágó RO Cutter pentru tevi din plastic si conducte BG Тръборез



HRC 53	230 mm	PVC	PP	PE	PEX	PP-R	PEX-AL	V SHAPE	HT1P605	42 mm	8	48
--------	--------	-----	----	----	-----	------	--------	---------	---------	-------	---	----



DE Rohrabsschneider EN Tube cutter FR Coupe-tube ES Cortatubos hasta HR Rezač cijevi HU Csővágó 42 mm RO Cutter pentru tevi BG Тръборез



HRC 53	SK5	PVC	PP	PE
PEX	PP-R	PEX-AL	V SHAPE	240 mm

HT1P606	max. 42 mm	6	36
---------	------------	---	----

DE Rohrabsschneider EN Tube cutter FR Coupe-tubes télescopique ES Cortatubos HR Teleskopski rezač cijevi HU Gyors beállítású csővágó RO Cutter pentru tevi cu actiune rapida BG Телескопичен тръборез



Cu, Al	GCR15	HRC 55-58
+1		

	∅	guide rollers		
HT1P611	3-32 mm	2	1	50
HT1P614	14-63 mm	4	1	25

DE Rohrschneider EN Tube cutter FR Coupe-tube pour l'aluminium et le cuivre ES Corta-tubos de tubos de aluminio y cobre HR Teleskopski rezač cijevi HU Alumínium és rézcső vágó RO Cutter pentru tevi din aluminiu si cupru BG Тръборез



6-35 mm	Al Cu			
				SUPPLY

HT1P612	6-35 mm	6	48
---------	---------	---	----

DE Universal Bördelgerät EN Flaring nut set FR Presse à brider les câbles ES Prensa para embridado de cables HR Preša za rubljenje cijevi HU Cső toldó készlet RO Set de expansie de tevi BG Инструмент за валцоване на тръби



Al Cu	GCR15	HRC 55-58
-------	-------	-----------

	∅		
HT1P623	15 mm	10	50
HT1P624	18 mm	10	50
HT1P625	22 mm	10	50

DE Entgrater EN Reamer FR Ebavureur ES desbarbadora para tubos HR Deburrer HU Cső sorjázó RO Debavor de tevi BG Шабър за отнемане на фаска външно и вътрешно



4-40 mm	Cu Al	PVC	PP
---------	-------	-----	----

HT1P620	4-40 mm	60	240
---------	---------	----	-----

DE Universal Bördelgerät EN Flaring nut set FR Presse à brider les câbles ES Prensa para embridado de cables HR Preša za rubljenje cijevi HU Cső toldó készlet RO Set de expansie de tevi BG Инструмент за валцоване на тръби



∅: 5, 6, 8, 10, 12, 16 mm



5-16 mm	90°	Al Cu
---------	-----	-------

HT1P627	5-16 mm	5	30
---------	---------	---	----

DE Universal Bördelgerät EN Flaring nut set FR Presse à brider les câbles ES Prensa para embridado de cables HR Preša za rubljenje cijevi HU Cső toldó készlet RO Set de expansie de tevi BG Инструмент за валцоване на тръби



∅: 3, 5, 6, 8, 10, 12, 14, 15, 16, 19 mm



3-19 mm	90°	Cu Al
---------	-----	-------

HT1P626	3-19 mm	1	10
---------	---------	---	----

DE Rohrbieger EN Pipe bender FR Cintreuse à tubes ES Dobladora de tubos HR Savijačica cijevi HU Kézi csőhajlító RO Îndoitor manual de tevi BG Инструменти за огъване на тръби



Cu Al	0-180°
-------	--------

HT1P630	1/4", 5/16", 3/8" 6,3 mm, 8 mm, 10 mm	1	20
---------	--	---	----

DE Eine Presse zum Ausdehnen von Rohren EN Manual tube expander FR Une presse pour dilater les tuyaux ES Una prensa para expandir tuberías HR Preša za širenje cijevi HU Prés a csövek kibővítéséhez RO O presă pentru țevi în expansiune BG Инструмент за разширяване на медни тръби



	∅		
HT1P628	6, 8, 10, 12, 16, 19, 22 mm 1/4", 5/16", 3/8", 1/2", 5/8", 3/4", 7/8"	10	20

DE Rohr Einfädler EN Manual pipe threader FR Fileteuse à tuyau ES Enhebrador de tubos HR Nareznice za cijevi HU Cső menetvágó készlet RO Set de filetare tevi BG Разширителна глава за експандер за тръби



6 die sizes:
1/4", 3/8", 1/2", 3/4", 1", 1 1/4"
Ratchet
Handle extension



STEEL	BSPT	9CR2	Ductile Iron
-------	------	------	--------------

HT1P635	1/4"-5/4"	1	4

DE Rohr Einfädler EN Manual pipe threader FR Fileteuse à tuyau ES Enhebrador de tubos HR Nareznice za cijevi HU Cső menetvágó készlet RO Set de filetare tevi BG Разширителна глава за експандер за тръби



6 die sizes:
1/2", 3/4", 1", 1 1/4", 1 1/2", 2"
Ratchet
2 handle extensions



STEEL	BSPT	9CR2	Ductile Iron
-------	------	------	--------------

HT1P636	1/2" - 2"	1	2

DE Gewindeschneidkopf EN Head for ratchet die stock FR Mandrin porte-taraud ES Cabeza de corte de rosca HR Glava za rezanje navoja HU Menetvágó fej RO Cap de filetat BG Разширителна глава за експандер



HT1P637	1/4"	1	20
HT1P638	3/8"	1	20
HT1P639	1/2"	1	20
HT1P640	3/4"	1	20
HT1P641	1"	1	20
HT1P642	5/4"	1	20
HT1P643	3/2"	1	8
HT1P644	2"	1	8

BSPT	9CR2
------	------

DE Crimpwerkzeug für PEX-Rohre EN Crimping tool for PEX pipes FR Sertisseuse pour raccords sur tubes PEX ES Engarzadora de conectores de tubería PEX HR Press klijesta za PEX cijevi HU Krimpelő eszköz PEX csövekhez RO Instrument de sertizare pentru țevi PEX BG Ръчна преса за PEX тръби



PEX-AL-PEX	40 kN	580-760 mm
------------	-------	------------

HT1P645	TH 16, TH20, TH26, TH32	1	1

DE Crimpeinsatz EN Dies FR Matrices TH ES Matrices HR Nastavak HU Csatlakozó csőkrimpeléshez RO Matrice pentru aparat de sertizare a țevilor BG Матрица за ръчна преса



40 kN

	Type		
HT1P650	TH	TH 16 - 16 mm	1 1
HT1P651		TH 20 - 20 mm	1 1
HT1P652		TH 26 - 26 mm	1 1
HT1P653		TH 32 - 32 mm	1 1
HT1P654	U	U 16 - 16 mm	1 1
HT1P655		U 20 - 20 mm	1 1
HT1P656		U 25 - 25 mm	1 1
HT1P657		U 32 - 32 mm	1 1

DE Muffenscheißgerät EN Thermoplastic pipe welder FR Soudeur de tuyaux thermoplastiques ES Máquina de soldadura de para tuberías termoplásticas HR Zavarivač termoplastične cijevi HU Hegesztő berendezés termoplasztikus csövekhez RO Mașină de sudat pentru țevi termoplastice BG Заваряваща машина за термoplastични тръби



LCD	850 W	0-300 °C	LOW TEMPERATURE PROTECTION
-----	-------	----------	----------------------------

	∅		
HT1P680	16, 20, 25, 32, 40, 50, 63 mm	1	2

DE 3 in 1 Gaslötkolben EN 3 in 1 soldering tool FR Lampe à souder à gaz ES Soplete soldador a gas HR Lemilice s napajanjem na plin HU Gáz forrasztópáka RO Ciocan de lipit cu gaz BG Газов поялник 3в1



3 in 1	30-70 W	PIEZO	GAS	CAPACITY 12 ml
max 60 min	1300 °C TORCH	550 °C HOT AIR GUN	350 °C SOLDERING IRON	BUTAN

	W		
HT2C400	30-70 W	12	72

DE 3 in 1 Gaslötkolben EN 3 in 1 soldering tool FR Lampe à souder à gaz ES Soplete soldador a gas HR Lemilice s napažanjem na plin HU Gáz forrasztópáka RO Ciocan de lipit cu gaz BG Газов поялник 3в1



3 in 1	220 W	PIEZO		CAPACITY 7 ml
	1300°C TORCH	550°C HOT AIR GUN	400°C SOLDERING IRON	PROPAN BUTAN

	W		
HT2C401	220 W	12	48

DE Lötbrenner EN Gas blow torch FR Torche à gaz ES Soplete de gas HR Plinska let lampa HU Gázégő RO Arzator cu gaz BG Горелка



1,3 kW	PIEZO		
PROPAN BUTAN			

	°C		
HT2C500	max. 1300°C	10	100

DE Gaslotlampe EN Gas soldering lamp FR Torche à gaz ES Lampa de gas para soldar HR Plinska let lampa HU Gázforrasztó RO Lampa de lipit cu gaz BG Газова горелка



360°	1,7 kW	PIEZO	PROPAN BUTAN

	°C		
HT2C501	max. 850°C	1	20

DE Gasbrenner EN Gas burner FR Chalumeau à gaz ES Soplete de gas HR Plamenik turbo propan HU Propán gázégő RO Arzator cu gaz BG Горелка



1,0 kW	360°	BUTAN	
PIEZO			

	°C		
HT2C505	1300°C	10	100

DE Gasbrenner EN Gas burner FR Chalumeau à gaz ES Soplete de gas HR Plamenik turbo propan HU Propán gázégő RO Arzator cu gaz BG Горелка



1,0 kW	360°	BUTAN	PIEZO
		CAPACITY 15 ml	

	°C		
HT2C509	1300°C	10	60

DE Turbo propan gas torch EN Turbo propan hand-brenner FR Bruleur à gaz ES Quemador de gas turbo HR Plamenik turbo propan HU Propán gázégő RO Arzator cu gaz BG Горелка



360°	3,3 kW	PROPAN	MAPP
TURBO			

	°C		
HT2C502	max. 2800°C	1	20

DE Turbo propan gas torch EN Turbo propan hand-brenner FR Bruleur à gaz ES Quemador de gas turbo HR Plamenik turbo propan HU Propán gázégő RO Arzator cu gaz BG Горелка



360°	2,0 kW	PROPAN	MAPP	TURBO
PIEZO		AUTO START/STOP		

	°C		
HT2C503	max. 2800°C	1	20

DE Adapter for propan gas torch EN Adapter fur propan hand-brenner FR Adaptateur ES Adaptador HR Adapter za plamenike HU Égő adapter RO Arzator cu gaz BG Адаптер за КОТЛОМ



G1" M x G7/16" F			for HT2C502 HT2C503
------------------	--	--	---------------------

HT2C504	1	100

HÖGERT
technik

DE Bauwerkzeuge

EN Building Tools

FR Outils De Construction

ES Herramientas De Construcción

HR Građevinski Alati

HU Építőipari Szerszámok

RO Unelte De Construcții

BG Строителни Инструменти





HÖGERT
teuhtnik

HT3S204

HÖGERT

HT3B50P

DE Schlosserhammer EN Machinist hammer FR Marteau de mécanicien ES Martillo de mecánico HR Bravarski čekić HU Gépész kalapács RO Ciocan mecanic BG Шлосерски чук



Folder	Weight	Head Size	Length	Box Qty	Case Qty
HT3B001	100 g	82 x 15 mm	260 mm	12	120
HT3B003	300 g	105 x 23 mm	300 mm	6	60
HT3B005	500 g	118 x 27 mm	320 mm	6	36
HT3B008	800 g	130 x 33 mm	350 mm	6	24
HT3B010	1000 g	135 x 36 mm	360 mm	6	12
HT3B015	1500 g	145 x 42 mm	380 mm	6	12
HT3B020	2000 g	155 x 42 mm	400 mm	6	12

C45
DIN 1041
DIN 1193
HRC 52-58
ERGO GRIP

DE Schlosserhammer EN Locksmith's hammer FR Marteau de mécanicien ES Martillo de mecánico HR Bravarski čekić HU Gépész kalapács RO Ciocan mecanic BG чук шлосерски



Folder	Weight	Head Size	Length	Box Qty	Case Qty
HT3B095	3000 g	160 x 57 mm	885 mm	2	4
HT3B097	5000 g	185 x 70 mm	905 mm	2	4

C45
FIBERGLASS HANDLE
HRC 50-58
DIN 1041

DE Monolithischer Latthammer EN Solid nail hammer FR Marteau de couvreur monobloc ES Martillo para clavos monobloque HR Stolarski čekić HU Bontó kalapács RO Ciocan de cuie BG Чук за пирони



Folder	Weight	Head Size	Length	Box Qty	Case Qty
HT3B031	600 g	170 x 30 mm	330 mm	6	24

MONOLITH
C45
HRC 50-58
ERGO GRIP

DE Monolithischer Maurerhammer EN Solid brick hammer FR Marteau de maçon monobloc ES Martillo de albañilería/ladrillo monobloque HR Zidarski čekić HU Bontó kalapács RO Ciocan de caramida solida BG Чук за тухли



Folder	Weight	Head Size	Length	Box Qty	Case Qty
HT3B033	600 g	170 x 31 mm	315 mm	6	24

MONOLITH
C45
HRC 50-58
ERGO GRIP

DE Schlosserhammer EN Machinist hammer FR Marteau de mécanicien ES Martillo de mecánico HR Bravarski čekić HU Gépész kalapács RO Ciocan mecanic BG Чук шлосерски



Folder	Weight	Head Size	Length	Box Qty	Case Qty
HT3B021	100 g	82 x 15 mm	260 mm	6	72
HT3B023	300 g	100 x 23 mm	278 mm	6	48
HT3B025	500 g	115 x 28 mm	290 mm	6	36
HT3B028	800 g	130 x 33 mm	350 mm	6	24
HT3B029	1000 g	135 x 36 mm	360 mm	6	12
HT3B038	1500 g	145 x 42 mm	380 mm	4	8
HT3B039	2000 g	155 x 47 mm	400 mm	4	8

C45
HRC 50-58
ERGO GRIP
FIBERGLASS HANDLE

DE Latthammer mit Glasfaserstiel EN Solid nail hammer FR Marteau de couvreur ES Martillo para clavos HR Stolarski čekić HU Ács kalapács RO Ciocan de cuie BG Чук за пирони



Folder	Weight	Head Size	Length	Box Qty	Case Qty
HT3B030	600 g	170 x 27 mm	330 mm	6	24

C45
DIN 7239
HRC 50-58
ERGO GRIP
FIBERGLASS HANDLE

DE Monolithischer Zimmermannshammer EN Monolithic carpentry hammer FR Marteau de menuisier monolithique ES Martillo de carpintería de una pieza HR Monolitni stolarski čekić HU Monolit asztalos kalapács RO Ciocan de tamplarie BG Чук кофражен монолитен



Folder	Weight	Head Size	Length	Box Qty	Case Qty
HT3B094	600 g	180 x 27 mm	365 mm	6	24

MONOLITH
C45
DIN 7239
HRC 50-58
ERGO GRIP

DE Tischlerhammer mit Glasfaserstiel EN Carpenter's hammer FR Marteau de charpentier ES Martillo de carpintero HR Tesarski čekić HU Asztalos kalapács RO Ciocanul tamplarului BG Чук дърводелски



Folder	Weight	Head Size	Length	Box Qty	Case Qty
HT3B034	450 g	128 x 29 mm	285 mm	6	24

C45
HRC 50-58
ERGO GRIP
FIBERGLASS HANDLE

DE Monolithischer Tischlerhammer **EN** Carpenter's hammer **FR** Marteau de menuisier **ES** Martillo de carpintero **HR** Tesarski čekić **HU** Asztalos kalapács **RO** Ciocanul tamplarului **BG** Чук дърводелски



MONOLITH	C45	HRC 50-58	ERGO GRIP	HT3B035	450 g	132 x 31,5 mm	326 mm	6	24

DE Gummihammer **EN** Rubber mallet **FR** Maillet en caoutchouc **ES** Martillo de goma negro **HR** Gumeni čekić **HU** Gumikalapács **RO** Ciocan de cauciuc **BG** Гумен чук



BLACK	ERGO GRIP

HT3B041	450 g	95 x 60 mm	320 mm	6	24
HT3B043	680 g	114 x 63 mm	334 mm	6	24
HT3B046	900 g	126 x 68 mm	743 mm	6	24

DE Gummihammer **EN** Rubber mallet **FR** Maillet en caoutchouc **ES** Martillo de goma negro **HR** Gumeni čekić **HU** Gumikalapács **RO** Ciocan de cauciuc **BG** Гумен чук



WHITE BLACK	STREAKS FREE	ERGO GRIP

HT3B044	450 g	95 x 62 mm	275 mm	6	24

DE Hammer mit Glasfaserstiel Rückschlagfreier **EN** Dead blow hammer with fibreglass handle **FR** Maillet en plastique avec manche en fibre de verre **ES** Maza de plástico con mango de fibra de vidrio **HR** Čekić bez povratnog udarca **HU** Erőelnyelő kalapács **RO** Ciocan cu bile metalice interne **BG** Чук противооткатен



DEAD BLOW	ERGO GRIP	DEAD BLOW

HT3B091	680 g	92 x 42 mm	248 mm	6	24

DE Steinmetzhammer mit Glasfasergriff **EN** Stonemason's hammer **FR** Marteau taillant **ES** Martillo para piedra vidrio **HR** Zidarski čekić s drškom od stakloplastike **HU** Monolit kőműves kalapács **RO** Ciocan de tamplarie monolitica **BG** Зидарен чук



C45	DIN 6475	HRC 50-58	ERGO GRIP	HT3B036	1000 g	95 x 40 mm	260 mm	6	12

DE Gummihammer **EN** Rubber mallet **FR** Maillet en caoutchouc **ES** Martillo de goma negro **HR** Gumeni čekić **HU** Gumikalapács **RO** Ciocan de cauciuc **BG** Гумен чук



BLACK	ERGO GRIP

HT3B045	800 g	120 x 73 mm	350 mm	6	24

DE Kunststoff Hammer **EN** Soft face hammer **FR** Maillet en caoutchouc **ES** Maza de goma **HR** Instalacijski čekić **HU** Puha gumikalapács **RO** Ciocan de cauciuc moale **BG** Инсталационен чук



NO DAMAGE	ERGO GRIP	FIBERGLASS HANDLE

HT3B048	32 mm	98 x 35 mm	255 mm	6	24

DE Gummihammer **EN** Rubber mallet **FR** Maillet en caoutchouc **ES** Maza de goma **HR** Gumeni čekić **HU** Gumikalapács **RO** Ciocan de cauciuc **BG** Гумен чук



WHITE BLACK	STREAKS FREE	FIBERGLASS HANDLE	ERGO GRIP

HT3B052	680 g	115 x 65 mm	305 mm	6	24

DE Äxte EN Axe FR Hache ES Hacha HR Sjekira HU Fejsze RO Topor BG Брадџа



	Weight	Head width	Head height	Head length	Box	Box count
HT3B060	600 g	145 × 105 mm	360 mm	6	24	
HT3B062	800 g	165 × 115 mm	380 mm	6	12	
HT3B064	1000 g	175 × 125 mm	400 mm	6	12	
HT3B066	1200 g	190 × 135 mm	450 mm	4	8	

DE Äxte EN Axe FR Hache ES Hacha HR Sjekira HU Fejsze RO Topor BG Брадџа



	Weight	Head width	Head height	Head length	Box	Box count
HT3B070	600 g	148 × 105 mm	320 mm	6	24	
HT3B071	800 g	165 × 115 mm	334 mm	6	12	
HT3B072	1000 g	175 × 125 mm	334 mm	4	12	
HT3B073	1250 g	190 × 135 mm	743 mm	4	8	

DE Blechscherе, gerade EN Tin snips, straight cut FR Cisaille aviation coupe droite ES Cizalla o cortachapas tipo aviación corte recto HR Škare za lim HU Lemezvágó olló RO Foarfece pentru plăci metalice BG Ножици за ламарина



	Length	Box	Box count
HT3B500	250 mm	5	50

DE Blechscherе, rechtsschneidend EN Tin snips, right cut FR Cisaille aviation coupe à droite ES Cizalla o cortachapas tipo aviación corte a la derecha HR Škare za lim HU Lemezvágó olló RO Foarfece pentru plăci metalice BG Ножици за ламарина



	Length	Box	Box count
HT3B502	250 mm	5	50

DE Spaltaxt EN Axe FR Merlin avec manche en bois ES Hacha HR Sjekira HU Fejsze RO Topor BG Брадџа



	Weight	Head width	Head height	Box	Box count
HT3B069	2000 g	195 × 77 mm	700 mm	2	4

DE Spaltaxt mit Glasfaserstiel EN Axe with handle FR Merlin avec manche en fibre de verre ES Hacha de rajar con empuñadura de fibra de vidrio HR Sjekira za cijepanje HU Hasító fejsze RO Topor despicat BG Брадџа клин



	Weight	Head width	Head height	Box	Box count
HT3B076	2000 g	185 × 77 mm	743 mm	2	4

DE Blechscherе, linksschneidend EN Tin snips, left cut FR Cisaille aviation coupe à gauche ES Cizalla o cortachapas tipo aviación corte a la izquierda HR Škare za lim HU Lemezvágó olló RO Foarfece pentru plăci metalice BG Ножици за ламарина



	Length	Box	Box count
HT3B501	250 mm	5	50

DE Gebogene Blechscherе, linksschneidend EN Offset tin snips, bent left FR Cisaille chantourneuse coupe gauche ES Tijeras cortachapa izquierdas HR Ukošene škare za lim HU Lemezvágó olló RO Foarfece pentru plăci metalice BG Ножици за ламарина странични

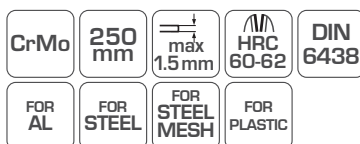

	Length	Box	Box count
HT3B504	250 mm	5	30



HÖGERT

HÖGERT

HÖGERT

DE Gebogene Blechscherer, rechtsschneidend EN Offset tin snips, bent right FR Cisaille chantourneuse coupe droite ES Tijeras cortachapa derechas HR Ukošene škare za lim HU Lemezvágó olló RO Foarfece pentru placi metalice BG Ножици за ламарина странични



CrMo	250 mm	$\frac{1}{2}$ max 1.5 mm	HRC 60-62	DIN 6438
FOR AL	FOR STEEL	FOR STEEL MESH	FOR PLASTIC	

HT3B505	250 mm	5	30

DE Pelikan Blechscherer EN Pelican Tin snips FR Cisaille à tôle pélican ES Cizalla pelicano para corte a izquierda y derecha HR Škare za lim HU Lemezvágó olló RO Foarfece pentru placi metalice BG Професионални ножици за изрязване



DIN 6438	$\frac{1}{2}$	HRC 55-60	$\frac{1}{2}$ max 1.0 mm
FOR AL	FOR STEEL MESH	FOR PLASTIC	

HT3B509	300 mm	6	24

DE Bolzenschneider EN Bolt cutter FR Cisailles à tiges ES Cortavarillas HR škare HU Csapszevágó RO Scule tăiere BG Ножици



	\varnothing max			
HT3B523	5 mm	350 mm	1	30
HT3B524	6 mm	450 mm	1	20
HT3B525	8 mm	600 mm	1	10
HT3B526	10 mm	750 mm	1	5
HT3B527	12 mm	900 mm	1	5

CrV	HRC 57-62
-----	-----------

DE Hydraulikschneider EN Hydraulic cutter FR Coupe-barre hydraulique ES Cortador hidráulico HR Hidraulični rezač HU Hidraulikus vágó RO Freză hidrolică BG Хидравлична ножица



STEEL	80 kN	\varnothing 4 - 16 mm	$\frac{1}{2}$ 410 mm	HRC 50-58
-------	-------	-------------------------	----------------------	-----------

HT3B548	4 - 16 mm	1	1

DE Blechscherer, gerade EN Tin snips, straight cut FR Cisaille à tôle coupe droite ES Cizalla o cortachapas corte recto HR Škare za lim HU Lemezvágó olló RO Foarfece pentru placi metalice BG Ножици за ламарина



DIN 6438	HRC 55-60	$\frac{1}{2}$ max 1.0 mm	FOR AL
FOR STEEL MESH	FOR PLASTIC		

HT3B506	260 mm	6	36

DE Bolzenscherer EN Bolt cutter FR Coupe-boulon à poignée bi-matière ES Cortador de pernos o cizalla con mango bimatierial HR Škare za rezanje šipki HU Hidegvágó RO Cleste pentru taiat bolturi BG Ножици за пръки



	\varnothing max			
HT3B519	7 mm	350 mm	1	20
HT3B520	8 mm	450 mm	1	10
HT3B521	10 mm	600 mm	1	10
HT3B522	12 mm	750 mm	1	5

CrV	HRC 54-56	HRC \leq 40
-----	-----------	---------------

DE Mini Bolzenscherer EN Mini bolt cutter FR Mini coupe-boulon à poignée bi-matière ES Mini cortador de pernos o cizalla con mango bimatierial HR Škare za rezanje žice HU Mini hidegvágó RO Cleste mini pentru taiat bolturi BG Ножици за тел



Mn65	max \varnothing 3.5mm
------	-------------------------

HT3B540	210 mm	6	36

DE Drahtbürste, vier Reihen, Draht aus Stahl EN Wire brush, steel wire FR Brosse métallique acier ES Cepillo metálico de acero HR Žičana četka HU Drótkefe RO Perii de sarma BG Стоманена четка



HT3B624	4x15	120 mm	290 mm	12	120
HT3B625	5x15	120 mm	290 mm	12	120
HT3B626	6x15	120 mm	290 mm	12	120

STEEL	$\frac{1}{2}$ 20
-------	------------------

DE Drahtbürste, vier Reihen, Draht aus Stahl EN Wire brush, steel wire FR Brosse métallique acier ES Cepillo metálico de acero HR Žičana četka HU Drótkefe RO Perii de sarma BG Стоманена четка



STEEL	ABS	ERGO GRIP	4x16	HT3B621	110 mm	250 mm	12	72
-------	-----	-----------	------	---------	--------	--------	----	----

DE Drahtbürste, vier Reihen, Draht aus rostfreiem Stahl EN Wire brush, steel wire FR Brosse métallique acier inoxydable ES Cepillo metálico de acero inoxidable HR Žičana četka HU Drótkefe RO Perii de sarma BG Стоманена четка



STAINLESS STEEL	ABS	ERGO GRIP	4x16	HT3B622	110 mm	250 mm	12	72
-----------------	-----	-----------	------	---------	--------	--------	----	----

DE Drahtbürste, vier Reihen, Draht aus Messing EN Wire brush, brass wire FR Brosse métallique laiton ES Cepillo metálico de latón HR Žičana četka HU Drótkefe RO Perii de sarma BG Четка месинг



BRASS	ABS	ERGO GRIP	4x16	HT3B623	110 mm	250 mm	12	72
-------	-----	-----------	------	---------	--------	--------	----	----

DE Surform EN Surform FR Rabot bloc surform ES Cepillo Surform HR Rašpa HU Reszelőgyalu RO Perii de sarma BG Ръчно ренде



STEEL	PVC	HT3B640	42 mm	140 mm	6	60
-------	-----	---------	-------	--------	---	----

DE Surform EN Surform FR Rabot bloc surform ES Cepillo Surform HR Rašpa HU Reszelőgyalu RO Pila cu adaptor BG Ръчно ренде



STEEL	PVC	HT3B641	42 mm	250 mm	6	60
-------	-----	---------	-------	--------	---	----

DE Glasschneider EN Glass cutter tool FR Coupe-verre ES Cortador de vidrio HR Rezač stakla HU Üvegvágó RO Taietor de sticla BG Нож за стъкло



x6	CARBIDE	WOODEN HANDLE	GLASS	ERGO GRIP	HT3B670	130 mm	6	240
----	---------	---------------	-------	-----------	---------	--------	---	-----

DE Meißel mit Schlaghandschutz EN Cold chisel with guard FR Burin plat avec protection Ergo Grip ES Cincel plano con protección HR Ravni rezač s poklopcem HU Lapos fejtű véső kézvédővel RO Dalta lata BG Секач ударен



CrV	TPE	ERGO GRIP	HT3B700	19 mm	255 mm	10	20
-----	-----	-----------	---------	-------	--------	----	----

DE Spitzmeißel mit Handschutz EN Concrete chisel with hand guard FR Burin en pointe avec protection ES Cincel en punta para hormigón con protección HR Probijač s poklopcem HU Hegyes fejtű véső kézvédővel RO Dalta ascuțita BG Шило ударно



CrV	TPE	ERGO GRIP	HT3B708	4 mm	16 mm	255 mm	10	20
-----	-----	-----------	---------	------	-------	--------	----	----

DE Werkzeugset – Körner, Meißel EN Chisel and punch set FR Pack de ciseaux et chasse-goupilles ES Paquete de tijeras y punzones HR Komplet rezača, točkala i izbijača HU Véső és lyukasztó készlet RO Set de dalt isi punctatoare BG Център автоматичен за маркиране



CrV	x6	HT3B710	10 x 142 mm, 10 x 152 mm	6	36
			2 x 140 mm, 3 x 152 mm 6 x 152 mm, 8 x 115 mm		

DE Werkzeug-Set Körner Meißel Splinttreiber EN Chisel and punch set FR Jeu de poinçons et ciseaux ES Cinceles y cortafrijos HR Komplet rezača, točkala i izbijača HU Véső és lyukasztó készlet RO Set de dalti si punctatoare BG Ударни дорници и секачи



CrV	x5	HT3B713	12 x 9,5 x 130 mm	10	40
			5 x 9,5 x 130 mm 4 x 9,5 x 150 mm 3,5 x 9,5 x 120 mm 4 x 9,5 x 120 mm		

DE Durchtreiber EN Pin punch FR Poinçon ES Cincel HR Bravarski izbijač HU Gépész lyukasztó RO Punctator mecanic BG Дорник ударен



CrV						
			HT3B724	3 x 8 x 152 mm	25	200
			HT3B725	4 x 8 x 152 mm	25	200
			HT3B726	5 x 8 x 152 mm	25	200
			HT3B727	6 x 10 x 152 mm	25	200

DE Feile für Metall EN Flat metal file FR Lime plate à métaux ES Lima plana metálica Ergo Grip HR Ravna turpija za metal HU Lapos fémrészlő RO Pila dreptunghiulara pentru metal BG Пила плоска за метал



T12 STEEL	ERGO GRIP	#2	200 mm
FOR STEEL	FOR PLASTIC	FLAT CONVERTIBLE	

HT3B800	200 mm	10	60

DE Werkzeugset – Körner, Meißel EN Chisel and punch set FR Pack de ciseaux et chasse-goupilles ES Paquete de tijeras y punzones HR Komplet rezača, točkala i izbijača HU Véső és lyukasztó készlet RO Set de dalti si punctatoare BG Център автоматичен за маркиране



CrV	x12	HT3B712	10 x 140 mm, 12 x 150 mm, 16 x 170 mm	6	12
			1,5 x 150 mm, 3 x 150 mm, 4 x 150 mm, 5 x 150 mm, 6 x 150 mm, 8 x 150 mm 2 x 140 mm, 6 x 100 mm, 8 x 115 mm		

DE Flach meißel EN Cold chisel FR Poinçon ES Cortafrijos HR Bravarski rezač HU Gépész lapos véső RO Dalta mecanica BG Секач ударен



CrV						
			HT3B721	10 x 8 x 142 mm	25	200
			HT3B722	13 x 10 x 150 mm	25	200
			HT3B723	16 x 13 x 150 mm	25	200

DE Körner EN Center punch FR Pointeau ES Granete HR Bravarsko točkalo HU Gépész pontozó RO Punctator mecanic BG Център автоматичен за маркиране



CrV						
			HT3B728	6 x 10 x 102 mm	25	200
			HT3B729	8 x 11 x 115 mm	25	200

DE Halbrundfeile für Metall EN Half-round metal file FR Lime demi-ronde à métaux ES Lima semi-redonda metálica Ergo Grip HR Poluokrugla turpija za metal HU Fél-kerek fémrészlő RO Pila semirotunda pentru metal BG Пила за метал полукръгла



T12 STEEL	ERGO GRIP	#2	200 mm
FOR STEEL	FOR PLASTIC	SEMICIRCLE	

HT3B801	200 mm	10	60

DE Rundfeile für Metall EN Round metal file FR Lime ronde à métaux ES Lima redonda metálica Ergo Grip HR Okrugla turpija za metal HU Kerek fémszszelő RO Pila rotunda pentru metal BG Пила за метал кръгла



T12 STEEL	ERGO GRIP	#2	200 mm
FOR STEEL	FOR PLASTIC	Ø8 mm	CIRCLE

HT3B802	200 mm	10	60
---------	--------	----	----

DE Dreiecksfeile für Metall EN Triangular metal file FR Lime triangulaire à métaux ES Lima triangular metálica Ergo Grip HR Trokutasta turpija za metal HU Háromszög alakú fémszszelő RO Pila triunghiulara pentru metal BG Триъгълна метална пила



T12 STEEL	ERGO GRIP	#2	200 mm
FOR STEEL	FOR PLASTIC	TRIANGLE	

HT3B804	200 mm	10	60
---------	--------	----	----

DE Diamant-Nadelfeile EN Diamond needle file FR Fichiers d'aiguille diamant ES Conjunto de limas de aguja de diamante HR Dijamantne igličaste turpije HU Gyémánt tűszszelő készlet RO Set de pile diamantate pentru metal BG Комплект диамантени пили игли



x5	A3 STEEL	ERGO GRIP	50 mm	Ø3 mm
CIRCLE	TRIANGLE	SQUARE	SEMICIRCLE	FLAT

HT3B808	3 mm	140 mm	12	240
---------	------	--------	----	-----

DE Diamant-Nadelfeile EN Diamond needle file FR Fichiers d'aiguille diamant ES Conjunto de limas de aguja de diamante HR Dijamantne igličaste turpije HU Gyémánt tűszszelő készlet RO Set de pile diamantate pentru metal BG Комплект диамантени пили игли



x10	GCR15 STEEL	ERGO GRIP	CIRCLE	TRIANGLE
SQUARE	SEMICIRCLE	FLAT	FLAT CONVERTIBLE	OVAL

HT3B809	3 mm	140 mm	12	120
---------	------	--------	----	-----

DE Holzraspel EN Flat wood rasp FR Lime plate à bois ES Lima plana para madera Ergo Grip HR Ravna turpija za grubu obradu drva HU Lapos farszszelő RO Pila dreptunghiulara pentru lemn BG Пила плоска за дърво



ERGO GRIP	200 mm	FLAT
-----------	--------	------

HT3B810	200 mm	10	60
---------	--------	----	----

DE Holzraspel, halbrund EN Half-round wood rasp FR Lime demi-ronde à bois ES Lima semi-redonda para madera HR Poluokrugla turpija za grubu obradu drva HU Fél-kerek farszszelő RO Pila semirotunda pentru lemn BG Пила полукръгла за дърво



ERGO GRIP	200 mm	SEMICIRCLE
-----------	--------	------------

HT3B811	200 mm	10	60
---------	--------	----	----

DE Holzflachmeißel EN Chisel FR Ciseau à bois avec manche en bois ES Cincel con mango de madera HR Ravno dljeto HU Lapos favéső RO Dalti pentru lemn BG Длето дърводелско



CrV	DIN 5139	WOODEN HANDLE	ERGO GRIP	140 mm
-----	----------	---------------	-----------	--------

HT3B841	8 mm	6	36
HT3B842	10 mm	6	36
HT3B843	12 mm	6	36
HT3B845	16 mm	6	36
HT3B848	20 mm	6	36
HT3B850	25 mm	6	36
HT3B852	32 mm	6	36

DE Brecheisen EN Crowbars FR Pied de biche avec corps hexagonal ES Palanca HR Građevinska poluga HU Feszítővasak RO Rangi BG Цанга тип кози крак



FORGED

HT3B880	16 x 450 mm	1	12
HT3B881	18 x 600 mm	1	12
HT3B882	19 x 750 mm	1	10

DE Beißzange EN Carpenter's pincers FR Tenaille russe ES Tenaza de carpintero HR Klijesta za čavle HU Asztalos csípőfogó RO Cleste pentru cuie BG Клеци за пирони



CrV HRC 58-62 ERGO GRIP

HT1P350	180 mm	6	60

DE Kneifzange EN Rabbit pincers FR Pince coupante devant ES Tenaza rusa HR Klijesta za malterisanje HU Kisfejű csípőfogó RO Cleste pentru dulgheri BG Клеци керпеден



CrV HRC 58-62 ERGO GRIP

HT1P356	250 mm	6	36
HT1P358	300 mm	6	36

DE Profilverbundzange EN Pliers for connecting profiles FR Pincés à lier pour profilés ES Alicates para conectar perfiles HR Klijesta za spajanje profila HU Profilrögzítő fogó RO Cleste pentru conectarea profilelor BG Кримпващи клещи



GR15 STEEL max 0.5-0.8 mm 275 mm

HT1P390	275 mm	6	24

DE Zange zum Verformen von Profilen, abgebogen EN Profile shaping pliers, curved FR Pincés à cintrer des profilés courbés ES Alicates de perfil, curva HR Klijesta za oblikovanje profila, savijena HU Profilformázó fogó, hajlított fejű RO Cleste pentru modelare a profilelor, curbat BG Кримпващи клещи, извити

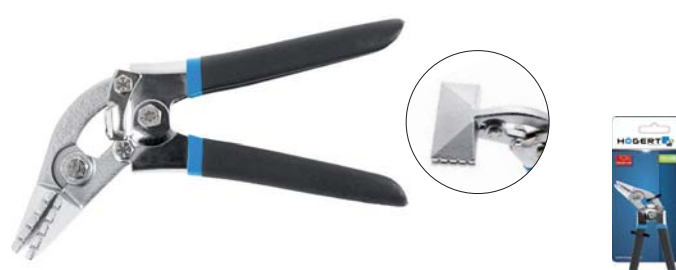

210 mm 80x35 mm

HT1P392	210 mm	2	12

DE Zange zum Verformen von Profilen, gerade EN Profile shaping pliers, straight FR Pincés à profilés, simples ES Alicates de perfil, rectos HR Klijesta za oblikovanje profila, ravna HU Profilformázó fogó, egyenes fejű RO Cleste pentru modelare a profilelor, drept BG Кримпващи клещи, прави



210 mm 80x35 mm 150x35 mm

HT1P393	210 mm	2	12
HT1P394	210 mm	2	12

DE Schraubzwinde EN F-clamp FR Serre-joint ES Abrazadera HR Stolarska stega HU Szorító RO Clema tip F BG Стяга дърводелска



DIN 5117 STEEL

HT3B902	15050 mm	1	50
HT3B904	250 × 50 mm	1	50
HT3B906	300 × 80 mm	1	30
HT3B908	300 × 120 mm	1	20
HT3B909	500 × 120 mm	1	10
HT3B910	800 × 120 mm	1	6
HT3B920	1000 × 120 mm	1	6
HT3B921	1200 × 120 mm	1	6
HT3B922	1500 × 120 mm	1	6

DE Tischler Schraubzwingen, geschmiedet EN Steel forged F-clamp FR Serre-joint menuisier forgé ES Sargenta forjada HR Kovana stolarska stega HU Kovácsolt szorító RO Clema tip F forjat BG Стоманена винтова стяга



FORGED STEEL

HT3B911	160 × 80 mm	10	30
HT3B912	200 × 80 mm	10	30
HT3B913	250 × 80 mm	10	30
HT3B914	300 × 80 mm	10	30
HT3B915	450 × 80 mm	10	20
HT3B916	400 × 120 mm	1	10
HT3B917	500 × 120 mm	1	10
HT3B918	600 × 120 mm	1	10

DE Hebelzwinde EN Lever clamp FR Serre-joints ES Mordaza de palanca HR Stezaljka poluge HU Karos pillanatszorító RO Clema levier BG Лостова стяга



FORGED STEEL

HT3B941	160 × 60 mm	6	24
HT3B942	200 × 60 mm	6	24
HT3B943	300 × 60 mm	6	24

DE Schnellspannzwinge, Einhandzwinge EN Ratchet bar clamp and spreader
FR Serre-joint à libération rapide ES Abrazadera de trinquete de liberación rápida
HR Stolarska stega za brzo stezanje HU Racsnis szorító és tágitó RO Clema cu clichet
pentru strangere si extensie BG Дърводелска стяга с тресчотков механизъм



	A	B	C	D		
HT3B935	100	34	73	183	12	120
HT3B936	150	63	146	360	6	24
HT3B937	300	63	146	510	6	24
HT3B938	450	63	146	660	6	12
HT3B939	600	63	146	810	6	12
HT3B940	900	63	146	1110	6	12

PA6 TPR STEEL BAR

DE Federzwingen EN Spring clamp FR Pince de serrage ES Abrazadera con resorte
HR Opružna stega HU Szorító csipesz RO Clema cu arc BG Ръчна пружинна стяга



HT3B944	110 mm	12	72	

x2 PE DURABLE SPRING max 38 mm

DE Federzwingen EN Spring clamp FR Pince de serrage ES Abrazadera con resorte
HR Opružna stega HU Szorító csipesz RO Clema cu arc BG Ръчна пружинна стяга



HT3B946	165 mm	20	120	

PE DURABLE SPRING max 60 mm

DE Ratschenspannzwinge EN Ratchet-lock spring clamp FR Pince de serrage avec blocage ES Abrazadera con resorte y trinquete HR Preklonpa stega HU Racsnis szorító csipesz RO Clema cu clichet si arc BG Ръчна стяга с тресчотков механизъм



HT3B950	100 mm	25 mm	12	96
HT3B952	150 mm	35 mm	12	96
HT3B954	200 mm	45 mm	12	48

PE

DE Winkelschraubstock EN Angle clamp FR Presse d'angle pivotante ES Prensa angular HR Kutna stega HU Derékszög szorító RO Clema pentru colturi BG Ъглова стяга



HT3B960	75 mm	1	20	

Aluminum 90° 75 mm 65 mm

DE Bandzwinge EN Clamp corner band strap FR Coin rapide de la bande de serrage sangle ES Prensa angular de cinta HR Tračna kutna stega HU Szalagos sarok szorító RO Clema pentru patru colturi cu banda BG Лентова стяга



HT3B963	4 m	1	20	

NYLON PVC NYLON 4 m x4

DE Fuchsschwanzsäge EN Hand saw FR Scie égoïne avec poignée ergonomique ES Sierra de mano con asa ergonómica HR Pila „Lisičji rep“ HU Rókafarkú fűrész RO Fierastrau pentru lemn BG Трион ръчен



HT3S202	400 mm	10	60	
HT3S204	450 mm	10	40	
HT3S206	500 mm	10	40	

FAST CUT 1 to 3 led cut HOOK 7 TPI HRC 44-46 ERGO GRIP

DE Rückensäge EN Back saw FR Scie à dos avec poignée ergonomique ES Sierra o serrucho de costilla con asa ergonómica HR Pila s ojačanim lednim dijelom HU Illesztő fűrész RO Fierastrau pentru lemn dreptunghiular BG Трион пасвател



HT3S232	350 mm	10	40	

FAST CUT 1 to 2 led cut 350 mm 11 TPI HRC 44-46 ERGO GRIP

DE Kompass-Säge EN Compass saw FR Boussole scie ES Hoja de sierra con mango HR Ubodna pila HU Nyeles ágfűrész RO Fierastrau subtire de mana BG Трион кръгов



HRC 44-46				ERGO GRIP				
HT3S234	300 mm	10	60					

DE Hacksaw for metal EN Hacksaw FR Sierra de arco para metales ES Sierra de arco para metales HR Pila za metal HU Keretes fűrész RO Fierastrau pentru metal BG Ръчна ножовка



HRC 42-44	AI		ERGO GRIP				
HT3S270	300 mm	6	24				

DE Bow saw, universal EN Universal bow saw FR Sierra universal ES Sierra universal HR Univerzalna lučna pila HU Univerzális keretes fűrész RO Fierastrau universal cu gama BG Универсален трион-лък



TPR HANDLE							
	METAL x2 WOOD x1	STEEL	45° & 90°	HT3S277	300 mm	1	12

DE Sägeblätter für Metall EN Hacksaw blades FR Lames de scie à métaux ES Hoja de sierra para metales HR List pile za metal HU Fűrészlapok fémhez RO Lame pentru bomfaiere BG Лист за ножовка



300 mm			BiMetal			TPI		
8% COBALT	x2	BiMetal M2+6150	58-64 HRC	HT3S285	300 x 12,7 mm	18	40	400
				HT3S286	300 x 12,7 mm	24	40	400

ABS								
HT3S295	300 x 140 x 80 mm	1	24					

DE Säge für GK-Platten EN Jab saw FR Scie à guichet ES Sierra de hender o serrucho HR Pila za gips-kartonske ploče HU Gipskarton fűrész RO Fierastrau pentru decupat gips-carton BG Трион за гипсокартон



HRC 44-46				ERGO GRIP				
HT3S238	150 mm	10	60					

DE Mini hacksaw frame with blade, hacksaw for metal EN Mini hacksaw FR Sierra para metales ES Sierra para metales HR Drška s listom pile HU Mini fémfűrész RO Fierastrau mini pentru metal BG Ръчна ножовка олекотена



HRC 58-60	LIGHT	TPR		ERGO GRIP				
HT3S274-D	300 mm	12	48					

DE Sägeblätter für Metall EN Hacksaw blades FR Lame pour scie à métaux ES Hoja de sierra para metales HR List pile za metal HU Fűrészlapok fémhez RO Lame pentru bomfaiere BG Лист за ножовка



HRC 58-64	BiMetal	x2	BiMetal M2+6150					
HT3S280	300 x 12,5 mm	24	144					

DE Gehrungslade EN Mitre box FR Boîte à onglets ES Caja de ingletes HR Mitra kutija HU Gérvágó láda RO Taietor de mitra BG Пластмасов шаблон за трион пасвател

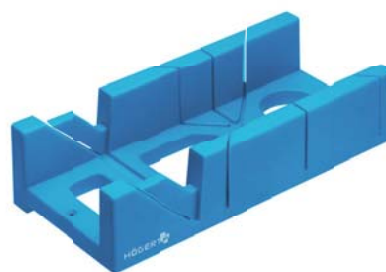

ABS								
HT3S295	300 x 140 x 80 mm	1	24					

DE Tischlerbleistift EN Carpenter's pencil FR Crayon de charpentier ES Lápiz de carpintero HR Carpenterova olovka HU Ácsceruza RO Creioane pentru tamplari BG Молив дърводелски



HB WOOD x 48

HT3B770	250 mm	1	960
---------	--------	---	-----

DE Maurerbleistift EN Masonry pencil FR Crayon de maçon ES Lápiz de albañil HR Zidarska olovka HU Kőműves ceruza RO Creioane pentru zidari BG Молив каменоделски



4H CONCRETE BRICK x 48

HT3B772	250 mm	1	960
---------	--------	---	-----

DE Bleistift für Glas EN Glass pencil FR Crayon pour verre ES Lápiz de vidrio HR Olovka za staklo HU Üveglelő ceruza RO Creioane pentru sticla BG Стъклен молив



R GLASS x 48

HT3B771	250 mm	1	960
---------	--------	---	-----

DE Permanentmarker EN Permanent marker FR Surligneur permanent ES Marcador permanente HR Stalni marker HU Alkoholos jelölő filc RO Marker permanent BG Перманентен маркер



QUICK DRYING NOT SMUDGING x 80

HT3B774	95 mm	2	6
---------	-------	---	---

DE Technische Kreide EN Technical chalk FR Craie industrielle ES Tiza técnica HR Tehnička kreda HU Műszaki kréta RO Creta tehnica BG Техническа креда



TEFLON GRANITE STEEL WOOD
TEXTILES GLASS x12

HT3B775	120 mm	1	50
HT3B776	120 mm	1	50
HT3B777	120 mm	1	50
HT3B778	120 mm	1	50

DE Profilmuster EN Profile gauge FR Modèle de profil ES Plantilla de perfil HR Predložak profila HU Profilsablon RO Șablon de profil BG Шаблон за копиране на профили



WIDTH 275 mm DEPTH 45 mm MAGNETIC

HT4M218	275 mm	10	40
---------	--------	----	----

DE Magnet werkstückhalter EN Magnetic welding holder FR Support de soudage magnétique ES Soporte de Soldadura magnética HR Magnetni kutnik za varenje, strijela HU Mágneses hegesztő adapter RO Adaptor magnetic de sudura BG Магнитен позиционер за заваряване

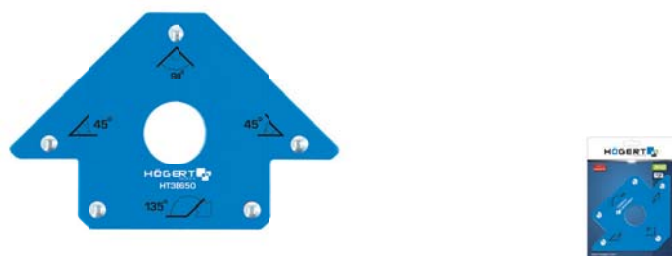

MAGNETIC 45° 90° 135° max Ø28 mm

HT3B650	34 kg	6	24
HT3B651	22,5 kg	6	24

DE Magnet werkstückhalter EN Magnetic welding holder FR Support de soudage magnétique ES Soporte de Soldadura magnética HR Magnetni kutnik za varenje, strijela, heksagon HU Hatszögű mágneses hegesztő adapter RO Adaptor hexagonal magnetic de sudura BG Магнитен позиционер за заваряване

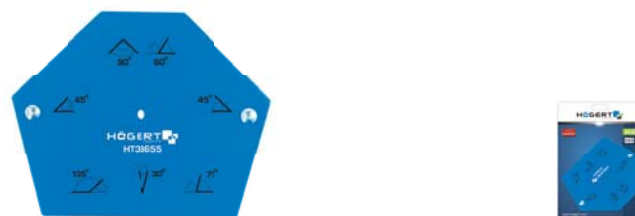

MAGNETIC 30° 45° 60° 75° 90° 135°

HT3B655	34 kg	8	16
HT3B656	22,5 kg	6	24
HT3B657	11,5 kg	6	48



45°



90°

45°

135°

HÖGERT
HIT36650

DE Magnet werkstückhalter EN Magnetic welding holder FR Support de soudage magnétique ES Soporte de Soldadura magnética HR Magnetni kutnik za varenje, trokut HU Mágneses háromszög alakú adapter RO Adaptor triunghiular magnetic de sudura BG Магнитен позиционер за заваряване

MAGNETIC

36,2 kg

30°

45°

60°

90°

max Ø28 mm

HT3B660	36,2 kg	6	24

DE Magnet werkstückhalter Satz EN Magnetic welding holder FR Support de soudage magnétique ES Soporte de Soldadura magnética HR Magnetski kutnik za varenje L-tipa HU L alakú mágneses hegesztő adapter RO Adaptor in forma de L magnetic de sudura BG Магнитен позиционер за заваряване

MAGNETIC

x2

60°

90°

120°

HT3B665	9 kg	6	24

DE Kartuschenpresse EN Caulking gun FR Pistolet à mastic ES Pistola de masilla HR Pištolji za kartuše plastične mase HU Kinyomó pisztoly RO Presa cartuse BG Пистолет за картуш



DOUBLE SYSTEM

ROTATION 360°

HT4R402	225 mm	1	24

DE Kartuschenpresse bis EN Caulking gun FR Pistolet à calfeutrer, pour tubes et cartouches ES Pistola de masilla para tubos y cartuchos HR Pištolji za kartuše plastične mase HU Kinyomó pisztoly RO Presa cartuse tip salam BG Пистолет за картуш





ROTATION 360°

300 ml

HT4R405	225 mm	1	20

DE Montageschaumpistole EN Foam gun FR Pistolet à mousse ES Pistola de aluminio para espuma HR Pištolj za montažnu pjenu HU Purhab kinyomó RO Presa cartuse cu spuma BG Пистолет за монтажна пена

PTFE PROTECTION



AI

STEEL NOZZLE

STEEL NEEDLE

HT4R422	340 mm	200 mm	1	20

DE Montageschaumpistole EN Foam gun FR Pistolet à mousse ES Pistola de aluminio para espuma HR Pištolj za montažnu pjenu HU Purhab kinyomó RO Presa cartuse cu spuma BG Пистолет за монтажна пена



AI

BRASS NOZZLE

STEEL NEEDLE

HT4R425	320 mm	195 mm	1	20

DE Schlüssel für Verteilerschränke EN Switch cabinet key FR Cle croix commutateur avec accessoires ES Llave de cruz universal para montar armarios HR Ključ za razvodne ormare HU Elosztódoboz kulcs RO Cheie pentru cutia de protecție BG Универсален ключ за шкафове

Zn

STEEL

5mm

8mm

9mm

10mm

6mm/PH2

1/4"

HT1W760	76 mm	20	200

DE Schlüssel für Verteilerschränke EN Switch cabinet key FR Cle croix commutateur avec accessoires ES Llave de cruz universal para montar armarios HR Ključ za razvodne ormare HU Elosztódoboz kulcs RO Cheie pentru cutia de protecție BG Универсален ключ за шкафове



Zn

STEEL

5mm

8mm

9mm

6,7,8,9 mm

7mm/PH2

1/4"

HT1W761	85 mm	20	200



DE Messgeräte

EN Measuring Tools

FR Outils De Mesure

ES Herramientas De Medición

HR Mjerni alati

HU Mérőszerszámok

RO Unelte De Măsură

BG Измерващи Инструменти





DE Bandmaß EN Tape measure FR Mètre ruban magnétique ES Cinta métrica HR Uvlačiv metar HU Mérőszalag RO Rulete de buzunar BG Ролетка

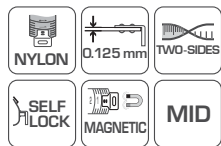

HT4M438	↔ 5 m ↓ 25 mm	4	24

DE Bandmaß EN Tape measure FR Mètre ruban magnétique ES Cinta métrica HR Uvlačiv metar HU Mérőszalag RO Rulete de buzunar BG Ролетка

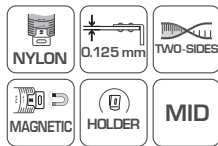

HT4M437	↔ 5 m ↓ 19 mm	6	48

DE Bandmaß EN Tape measure FR Mètre ruban magnétique ES Cinta métrica HR Uvlačiv metar HU Mérőszalag RO Rulete de buzunar BG Ролетка

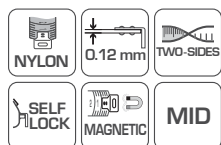

HT4M400	↔ 3 m ↓ 16 mm	12	120
HT4M401	↔ 5 m ↓ 19 mm	12	120
HT4M402	↔ 8 m ↓ 25 mm	6	60

DE Bandmaß EN Tape measure FR Mètre ruban magnétique ES Cinta métrica automática y ergonómica HR Uvlačiv metar HU Mérőszalag RO Rulete de buzunar BG Ролетка

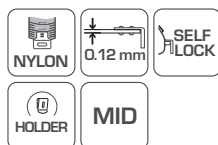

HT4M423	↔ 3 m ↓ 16 mm	12	120
HT4M425	↔ 5 m ↓ 19 mm	12	96

DE Bandmaß EN Tape measure FR Mètre ruban magnétique ES Cinta métrica automática y ergonómica HR Uvlačiv metar HU Mérőszalag RO Rulete de buzunar BG Ролетка

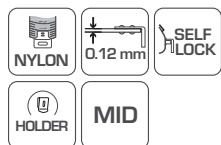

HT4M426	↔ 5 m ↓ 25 mm	6	60
HT4M428	↔ 8 m ↓ 25 mm	6	48

DE Bandmaß EN Tape measure FR Mètre ruban magnétique ES Cinta métrica automática y ergonómica HR Uvlačiv metar HU Mérőszalag RO Rulete de buzunar BG Ролетка

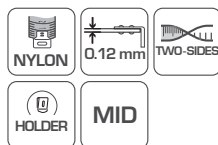

HT4M405	↔ 3 m ↓ 16 mm	12	120
HT4M406	↔ 5 m ↓ 19 mm	12	120
HT4M407	↔ 8 m ↓ 25 mm	6	60

DE Bandmaß EN Steel tape measure FR Ruban à mesurer ES Cinta métrica automática con imán HR Uvlačiv metar s magnetom HU Mágneses mérőszalag RO Rulete de buzunar cu magnet BG Стомана ролетка

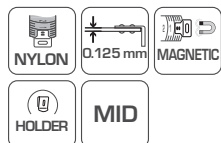

HT4M432	↔ 3 m ↓ 16 mm	12	120
HT4M433	↔ 5 m ↓ 19 mm	12	72
HT4M434	↔ 8 m ↓ 25 mm	6	48

DE Bandmaß EN Steel tape measure FR Mètre ruban acier ES Metro metálico extensible con bloqueo HR Uvlačiv metar HU Mérőszalag RO Rulete de buzunar BG Стомана ролетка

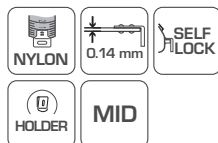

HT4M435	↔ 5 m ↓ 19 mm	12	72

DE Bandmaß EN Steel tape measure FR Mètre ruban acier ES Metro metálico extensible con bloqueo HR Uvlačiv metar HU Mérőszalag RO Rulete de buzunar BG Стомана ролетка

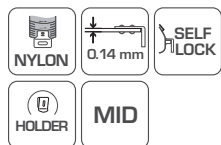

HT4M436	↔ 5 m ⊕ 25 mm	6	72

DE Bandmaß EN Steel tape measure FR Mètre ruban acier ES Metro metálico extensible con bloqueo HR Uvlačiv metar HU Mérőszalag RO Rulete de buzunar BG Стомана ролетка



HT4M409	↔ 3 m ⊕ 16 mm	12	120
HT4M410	↔ 5 m ⊕ 19 mm	12	120
HT4M411	↔ 8 m ⊕ 25 mm	6	60

DE Bandmaß EN Steel tape measure FR Ruban à mesurer ES Cinta métrica automática HR Uvlačiv metar HU Mérőszalag RO Rulete de buzunar BG Стомана ролетка



HT4M429	↔ 3 m ⊕ 16 mm	12	120
HT4M430	↔ 5 m ⊕ 19 mm	12	72
HT4M431	↔ 8 m ⊕ 25 mm	6	48

DE Kapselbandmass EN Steel tape measure FR Triple décimètre ES Cinta métrica de acero HR Čelična metar HU Hosszú acél mérőszalag RO Masura lunga din otel BG Ролетка със стоманена лента



HT4M473	↔ 30 m ⊕ 9,5 mm	10	40

DE Kapselbandmass EN Steel tape measure FR Triple décimètre ES Cinta métrica de acero HR Čelična metar HU Hosszú acél mérőszalag RO Masura lunga din otel BG Ролетка със стоманена лента



HT4M475	↔ 50 m ⊕ 12,5 m	10	20

DE Glasfaser-Rollbandmaß EN Fibreglass measure FR Mètre ruban en fibre de verre ES Cinta métrica de fibra de vidrio HR Metar od fiberglasa HU Üvegszálás mérőszalag RO Masura din fibra de sticla BG Дълга ролетка от фибростъкло

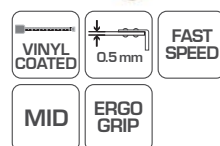

HT4M476	↔ 10 m ⊕ 15 mm	1	60
HT4M477	↔ 20 m ⊕ 15 mm	1	60
HT4M478	↔ 30 m ⊕ 15 mm	1	40
HT4M479	↔ 50 m ⊕ 15 mm	1	30

DE Laser-Entfernungsmesser EN Laser Distance Meter FR Télémètre à laser ES Telémetro láser HR Laserski metar HU Lézeres távolságmérő RO Control distanta laser BG Лазерен далекомер



HT4M322	40 m	1	60
HT4M323	60 m	1	60
HT4M324	80 m	1	40

DE Holz Zollstock EN Wooden tape measure FR Règle pliante en bois ES Metro plegable de madera HR Drvena člankasta mjerka HU Mérőléc RO Metre pliabile BG Дървен сгъваем метър



HT4M261-D	↔ 1 m ⊕ 2,3 mm ⊕ 16 mm	20	200

DE Holz Zollstock EN Wooden tape measure FR Règle pliante en bois ES Metro plegable de madera HR Drvena člankasta mjerka HU Mérőlécs RO Metre pliabilă BG Дървен съгъваем метър



HT4M262	↔ 2 m ⊥ 2,3 mm ↗ 16 mm	10	100

DE Messschieber EN Vernier caliper FR Pied à coulisse ES Calibrador o Pie de Rey HR Pomična mjerka HU Tolómérő RO Subler BG Шублер



DIN 862

HT4M270	↗ 150 mm ↔ 230 mm	10	50

DE Digitaler Messschieber EN Digital caliper FR Pied à coulisse digital ES Calibrador digital HR Digitalna pomična mjerka HU Digitális tolómérő RO Subler digital BG Дигитален шублер

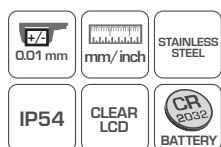

HT4M274	↗ 150 mm ↔ 230 mm	10	50

DE Schreiner Alu-Winkel EN Aluminium carpenter square FR Equerre aluminium ES Escuadra de carpintero HR Stolarski kutnik HU Alumínium asztalos derékszög RO Echer dulgher din aluminiu BG Дърводелски ъгъл



HT4M202	↔ 250 mm ⊥ 190 mm	1	100
HT4M203	↔ 350 mm ⊥ 190 mm	12	60
HT4M206	↔ 450 mm ⊥ 190 mm	1	100

DE Schreiner - Winkel EN Aluminium carpenter square FR Equerre de menuisier en aluminium ES Escuadra de carpintero de aluminio 300mm HR Stolarski kutnik HU Alumínium asztalos derékszög RO Echer dulgher din aluminiu BG Дърводелски ъгъл

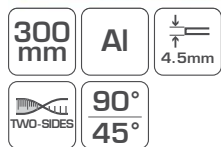

HT4M214	300 x 4,5 mm	6	24

DE Dreieck Winkel Schreiner EN Carpenter square FR Equerre de charpente triangulaire ES Escuadra de carpintero HR Tesarski kutnik HU Asztalos derékszög RO Echer dulgher din aluminiu BG Измервателен триъгълник дърводелски

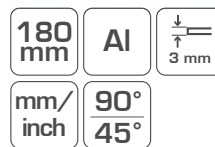

HT4M215	180 x 3 mm	12	60

DE Dreieck Winkel Schreiner EN Carpenter square FR Equerre de charpente triangulaire ES Escuadra de carpintero HR Tesarski kutnik HU Asztalos derékszög RO Echer dulgher din aluminiu BG Измервателен триъгълник дърводелски

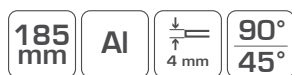

HT4M216	185 x 4 mm	12	60

DE Kombinationswinkel EN Combination square FR Combination square ES Escuadra de carpintero con nivel HR Stolarski kutnik sa libelom HU Asztalos derékszög vizmértékkel RO Echer dulgher cu dreptare BG Прав ъгъл с нивелир

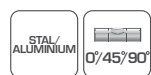

HT4M217	300 mm/12"	10	60

DE Wasserwaage EN Spirit level FR Niveau à fioles ES Nivel con burbujas HR Libela HU Vízmerő RO Dreptare BG Нивелир с три либели

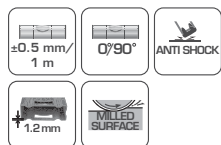

HT4M001-D	↔ 20 cm	⊥ 5,65 cm	↗ 2,1 cm	30	60
-----------	---------	-----------	----------	----	----

DE Wasserwaage Torpedo EN Spirit level torpedo FR Niveau magnétique Torpedo ES Nivel magnético Torpedo con burbujas HR Libela s magnetom HU Mágneses vízmerő RO Dreptare cu magnet BG Нивелир с три либели

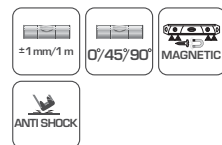

HT4M040	↔ 22 cm	⊥ 4,72 cm	↗ 2,0 cm	1	50
---------	---------	-----------	----------	---	----

DE Wasserwaage EN Aluminium level FR Niveau Aluminium ES Nivel de aluminio HR Alumijska libela HU Alumínium vízmerő RO Dreptare din aluminiu BG Професионален алуминиев нивелир с три либели

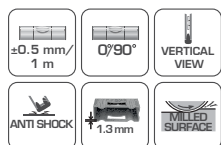

HT4M003	23 cm	1	24
---------	-------	---	----

DE Wasserwaage EN Aluminium level, vertical view FR Niveau Aluminium ES Nivel de aluminio HR Alumijska libela HU Alumínium vízmerő RO Dreptare din aluminiu BG Професионален алуминиев нивелир с три либели

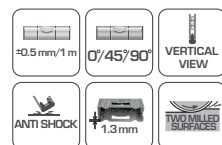

HT4M005	40 cm	1	30
HT4M007	60 cm	1	20
HT4M009	80 cm	1	20
HT4M011	100 cm	1	20
HT4M013	120 cm	1	20
HT4M016	150 cm	1	20
HT4M021	200 cm	1	10

DE Wasserwaage EN Spirit level FR Niveau Aluminium ES Nivel de aluminio HR Libela HU Vízmerő RO Dreptare BG Нивелир

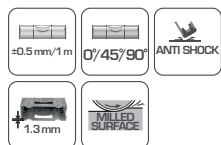

HT4M006	↔ 60 cm	⊥ 5,65 cm	↗ 2,1 cm	1	30
HT4M008	↔ 80 cm	⊥ 5,65 cm	↗ 2,1 cm	1	20
HT4M010	↔ 100 cm	⊥ 5,65 cm	↗ 2,1 cm	1	20
HT4M012	↔ 120 cm	⊥ 5,65 cm	↗ 2,1 cm	1	20
HT4M015	↔ 150 cm	⊥ 5,65 cm	↗ 2,1 cm	1	20
HT4M020	↔ 200 cm	⊥ 5,65 cm	↗ 2,1 cm	1	20

DE Stativ für Selbstnivellierung Laserkreuz EN Tripod for Laser levels FR Trépied pour Niveau Laser Autonivelant ES Trípode para Laseritase HR Stativ za Laserska Razina HU Állvány számára Lézeres szint RO Trepied pentru Nivelul laser BG Статив за лазерен нивелир



HT4M079	35 - 105 cm	1	25
---------	-------------	---	----

DE Laserkreuz EN Laser level red FR Niveau Laser Autonivelant ES Laseritase HR Laserska Razina HU Lézeres szint RO Nivelul laser BG Лазерен нивелир

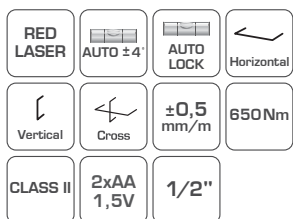

HT4M070	10 m	1	10
---------	------	---	----

DE Laserkreuz EN Laser level red FR Niveau Laser Autonivelant ES Laseritase HR Laserska Razina HU Lézeres szint RO Nivelul laser BG Лазерен нивелир

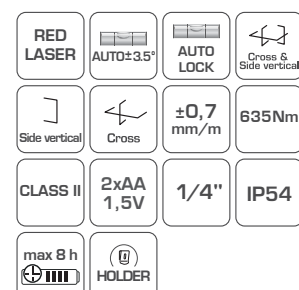

HT4M071	24 m	1	10
---------	------	---	----

DE Laserkreuz **EN** Laser level red 3D **FR** Niveau Laser Autonivelant **ES** Laseritase
HR Laserska Razina **HU** Lézeres szint **RO** Nivelă laser **BG** Лазерен нивелир



RED LASER	AUTO ± 4'	AUTO LOCK	3D Horizontal
Side vertical	3D horizontal & side vertical	±0,5 mm/m	635-660 Nm
CLASS II	4xAA 1,5V	1/4"	IP54
max 10 h	HOLDER		



HT4M072	30 m	1	10
---------	------	---	----

DE Laserkreuz **EN** Laser level green **FR** Niveau Laser Autonivelant **ES** Laseritase
HR Laserska Razina **HU** Lézeres szint **RO** Nivelă laser **BG** Лазерен нивелир



GREEN LASER	AUTO ± 4'	AUTO LOCK	Cross
±0,3 mm/m	505-520 Nm	CLASS II	2x1Ah AA Ni-Mh
1/4"	IP54	max 18 h	MAGNETIC
HOLDER			



HT4M074	23 m	1	10
---------	------	---	----

DE Entfernungsmesser **EN** Profile detector **FR** Détecteur de matériaux **ES** Buscador De Estudios
HR Detektor profila **HU** Vezeték detektor **RO** Detector profile **BG** Детектор за стени



I /	I 100 mm	Cu 80 mm
40 mm	38 mm	99.999 m ft inch

HT4M340	122 g	1	20
---------	-------	---	----

DE Entfernungsmesser mit Hygrometer **EN** Profile detector with hygrometer **FR** Détecteur de matériaux avec hygromètre **ES** Buscador De Estudios con higrómetro
HR Detektor profila s higrometrom **HU** Profildetektor higrométerrel **RO** Detector profile cu higrometru **BG** Детектор за стени с хигрометър



I /	I 60 mm	Cu 50 mm
50 mm	38 mm	%

HT4M341	113 g	1	20
---------	-------	---	----

DE Entfernungsmesser mit Laser-Entfernungsmesser 40m **EN** Profile detector with laser distance meter **FR** Détecteur de montant avec télémètre laser **ES** Buscador De Estudios con medidor de distancia láser **HR** Detektor profila s laserskim metrom **HU** Profildetektor és lézeres távolságmérő **RO** Detector profil esi control de distanță laser **BG** Детектор за стени с лазерен далекомер



I 100 mm	Cu 80 mm	40 mm	38 mm
40 m	m	m	m

HT4M342	118 g	1	20
---------	-------	---	----



WALL DETECTOR



DE Schneidwerkzeuge
EN Cutting Tools
FR Outils De Coupe
ES Herramientas De Corte
HR Rezni Alati
HU Vágóeszközök
RO Scule De Tăiere
BG Режещи Инструменти





DE Betonbohrer EN Masonry drill bit FR Foret à béton ES Broca para cemento HR Svrđala za beton HU SDS+ kőműves fúrósász RO SDS+ set de burghii dulgher BG Сврџло за бетон



Folder	Ø	Length	Flute Length	Box	Box
HT7D915	6	110 mm	60 mm	100	400
HT7D916	6	160 mm	110 mm	80	320
HT7D917	6	210 mm	160 mm	60	240
HT7D918	6	260 mm	210 mm	50	200
HT7D923	8	160 mm	110 mm	80	320
HT7D924	8	210 mm	160 mm	50	200
HT7D925	8	260 mm	210 mm	50	200
HT7D929	10	160 mm	110 mm	60	240
HT7D930	10	210 mm	160 mm	50	200
HT7D931	10	260 mm	210 mm	50	200
HT7D933	10	460 mm	410 mm	30	120
HT7D934	10	600 mm	550 mm	20	80
HT7D937	12	210 mm	150 mm	50	200

Folder	Ø	Length	Flute Length	Box	Box
HT7D938	12	260 mm	200 mm	40	160
HT7D941	12	460 mm	400 mm	25	100
HT7D942	12	600 mm	540 mm	15	60
HT7D945	14	260 mm	200 mm	30	120
HT7D950	14	600 mm	540 mm	15	60
HT7D955	16	460 mm	400 mm	15	60
HT7D956	16	600 mm	540 mm	10	40
HT7D960	18	460 mm	400 mm	10	40
HT7D961	18	600 mm	540 mm	10	40
HT7D964	20	460 mm	400 mm	10	40
HT7D965	20	600 mm	540 mm	5	20
HT7D973	24	600 mm	540 mm	5	20

DE Betonbohrer EN Masonry drill bit FR Foret à béton à taillants et double cannelure ES Broca para hormigón con punta HR Svrđala SDS plus za beton HU SDS+ kőműves fúrósász RO SDS+ set de burghii dulgher BG Комплект сверџла за бетон



Folder	Ø	Length	Flute Length	Box	Box
HT6D201	4,0	110 mm	50 mm	50	300
HT6D202	5,0	110 mm	50 mm	50	300
HT6D203	5,0	160 mm	90 mm	60	180
HT6D204	6,0	110 mm	50 mm	50	32
HT6D205	6,0	160 mm	90 mm	60	180
HT6D206	6,0	210 mm	135 mm	50	150
HT6D207	6,0	260 mm	185 mm	50	150
HT6D209	8,0	160 mm	90 mm	60	180
HT6D210	8,0	210 mm	135 mm	50	150
HT6D213	10,0	160 mm	90 mm	50	150
HT6D214	10,0	260 mm	185 mm	50	150
HT6D215	10,0	350 mm	280 mm	25	100

Folder	Ø	Length	Flute Length	Box	Box
HT6D218	12,0	160 mm	90 mm	50	150
HT6D220	12,0	260 mm	185 mm	50	150
HT6D224	12,0	600 mm	490 mm	20	80
HT6D226	14,0	260 mm	185 mm	40	120
HT6D231	14,0	600 mm	490 mm	1	50
HT6D233	16,0	260 mm	185 mm	25	75
HT6D236	16,0	600 mm	490 mm	10	40
HT6D237	18,0	260 mm	185 mm	15	45
HT6D240	18,0	600 mm	490 mm	10	40
HT6D242	20,0	600 mm	490 mm	5	40
HT6D248	24,0	600 mm	490 mm	1	20

DE Betonbohrer EN Masonry drill bit set FR Pack de forets à béton à taillants et double cannelure ES Paquete de brocas para hormigón HR Set svrđala SDS plus HU SDS+ kőműves fúrósász készlet RO SDS+ set de burghii dulgher BG Комплект сверџла за бетон

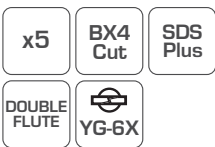

Folder	Ø	Length	Flute Length	Box	Box
HT6D370	5,0	110 mm	50 mm	5	30
	6,0	110 mm	50 mm		
	6,0	160 mm	90 mm		
	8,0	160 mm	90 mm		
	10,0	160 mm	90 mm		

DE Flachmeißel EN Flat chisel FR Ciseau plat ES Cincel plano HR Ravna dljijeta SDS plus HU SDS+ lapos vésósász RO Dalta lata SDS+ BG Длето плоско

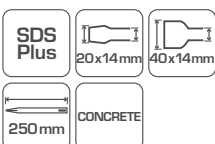

Folder	Length	Box	Box
HT6D281	20 x 14 x 250 mm	1	75
HT6D282	40 x 14 x 250 mm	1	75

DE Spitzmeißel EN Pointed chisel FR Burin pointu ES Cincel de punta HR Šiljasto dljijeto SDS plus HU SDS+ hegyes vésósász RO Dalte ascutite SDS+ BG Длето конусно

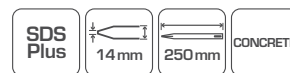

Folder	Length	Box	Box
HT6D280	14 x 250 mm	1	80

DE Kanalmeißel EN Gouge chisel FR Ciseau à gouge ES Cincel de ranura HR Dlijijeto za žljebljenje SDS plus HU SDS+ marósász RO Dalte canale SDS+ BG Длето канално

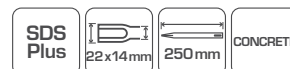

Folder	Length	Box	Box
HT6D284	22 x 14 x 250 mm	1	50

DE Adapter für Diamant Lochsäge EN Adapter for hole saw drill bits FR Adaptateur couronne diamantée ES Adaptador para broca HR SDS plus adapter za dijamantnu krunu za bušenje HU SDS+ adapter gyémánt koronafúróhoz RO Adaptor SDS+ pentru carote diamantate BG Адаптер за боркорона

DE Adapter für Bohrkronen für Beton EN Adapter for hole saw drill bits FR Adaptateur pour forets à pointe carbure ES Adaptador broca de corona para hormigón HR Adapteri za krune od sinteriranog karbida za bušenje HU Adapter SDS+ karbidbetétes koronafúróhoz RO Adaptor pentru carote cu inzerturi de carbid BG Адаптер за боркорона



				For: HT6D476 HT6D478				
					HT6D470	110 mm	1	100

				For: HT6D484 HT6D486 HT6D487 HT6D489				
					HT6D490	110 mm	1	100

DE Diamant Lochsäge EN Diamond hole saw FR couronne diamantée ES Broca de corona de diamante HR Segmentirane dijamantne krune za bušenje HU Szegetált gyémánt koronafúró RO Carota diamantata pentru gaurire BG Диамантена боркорона

DE Bohrkronen für Beton EN Carbide hole-saw drill bits FR Forets à noyau carbure pour béton ES Broca de corona para hormigón HR Krune od sinteriranog karbida za bušenje HU Karbidbetétes koronafúrófej RO Carote cu inzerturi de carbid BG Диамантена боркорона



					HT6D476	67 mm	1	25
					HT6D478	82 mm	1	25

				HT6D484	65 mm	1	40
				HT6D486	67 mm	1	20
				HT6D487	80 mm	1	20
				HT6D489	83 mm	1	20

DE Spitzmeißel EN Pointed chisel FR Burin pointu ES Cincel de punta HR Šiljasto dljeto HU Hegyes vésőszár RO Dalte ascuțite BG Длето конусно

DE Flachmeißel EN Flat chisel FR Burin plat ES Cincel plano HR Ravna dljeta HU Lapos vésőszár RO Dalta lata BG Длето плоско



				HT6D290	18 x 400 mm	1	25

				HT6D291	25 x 18 mm	1	25
				HT6D292	50 x 18 mm	1	25

DE Adapter für Bohrkronen für Beton EN Adapter for hole saw drill bits FR Adaptateur pour forets ES Adaptador HR Adapteri za krune od sinteriranog karbida za bušenje HU Adapter SDS+ karbidbetétes koronafúróhoz RO Adaptor pentru carote cu inzerturi de carbid BG Адаптер за боркорона

DE Betonbohrer EN Masonry drill bit FR Foret à béton à taillants ES Broca para hormigón con punta HR Svrđala za beton HU Kőműves fúrószár készlet RO Set de burghii dulgher BG Свредло за бетон



				For: HT6D484 HT6D486 HT6D487 HT6D489				
					HT6D492	160 mm	1	50

				HT6D380	4,0 75 mm 45 mm	100	400
				HT6D381	5,0 85 mm 45 mm	100	400
				HT6D382	6,0 100 mm 60 mm	100	400
				HT6D383	6,0 150 mm 100 mm	50	400
				HT6D384	8,0 120 mm 75 mm	50	400
				HT6D385	8,0 200 mm 140 mm	50	200
				HT6D388	10,0 120 mm 75 mm	50	200
				HT6D389	10,0 200 mm 140 mm	50	200
				HT6D392	12,0 120 mm 75 mm	50	200

DE Betonbohrersatz EN Masonry drill bit set FR Jeu de forets à béton ES Juego de brocas para cemento HR Set svrdala za beton HU Kőműves fúrószer RO Burghii dulgher BG Комплект свердела за бетон



Folder	Ø	Length	Flute Length	Box	Box
HT6D378	4 mm	75 mm		6	60
	5 mm	85 mm			
	6 mm	100 mm			
	8 mm	120 mm			
	10 mm	120 mm			

DE Metallbohrer EN Metal drill bit set FR Jeu de 6 forets à métaux ES Paquete de de brocas para metal HR Set svrdala za metal HU Fúrószer készlet fémhez RO Burghii pentru metal BG Комплект свердела

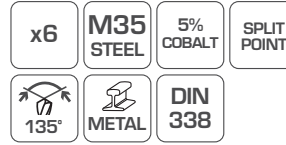

Folder	Ø	Length	Flute Length	Box	Box
HT6D186	2,0	49 mm	24 mm	6	60
	3,0	61 mm	33 mm		
	4,0	75 mm	43 mm		
	5,0	86 mm	52 mm		
	6,0	93 mm	57 mm		
	8,0	117 mm	75 mm		

DE Metallbohrer EN Masonry drill bit FR Set de forets pour métal ES Broca para metal HR Svrdala za metal HU Fúrószer fémhez RO Burghii pentru metal BG Средло за метал



Folder	Ø	Length	Flute Length	Box	Box
HT6D802	1,0	34 mm	12 mm	50	300
HT6D807	1,5	40 mm	18 mm	50	300
HT6D812	2,0	49 mm	24 mm	50	300
HT6D817	2,5	57 mm	30 mm	50	300
HT6D822	3,0	61 mm	33 mm	50	300
HT6D824	3,2	65 mm	36 mm	50	300
HT6D825	3,3	65 mm	36 mm	50	300
HT6D827	3,5	70 mm	39 mm	50	300
HT6D832	4,0	75 mm	43 mm	50	300
HT6D834	4,2	75 mm	43 mm	10	100
HT6D837	4,5	80 mm	47 mm	10	100
HT6D840	4,8	86 mm	52 mm	10	100
HT6D842	5,0	86 mm	52 mm	10	100
HT6D844	5,2	86 mm	52 mm	10	100
HT6D847	5,5	93 mm	57 mm	10	100
HT6D852	6,0	93 mm	57 mm	10	100
HT6D854	6,2	101 mm	63 mm	10	60

Folder	Ø	Length	Flute Length	Box	Box
HT6D857	6,5	101 mm	63 mm	10	60
HT6D862	7,0	109 mm	69 mm	10	60
HT6D867	7,5	109 mm	69 mm	10	60
HT6D872	8,0	117 mm	75 mm	10	60
HT6D874	8,2	117 mm	75 mm	10	60
HT6D877	8,5	117 mm	75 mm	10	60
HT6D882	9,0	125 mm	81 mm	10	60
HT6D887	9,5	125 mm	81 mm	10	60
HT6D892	10	133 mm	87 mm	10	40
HT6D893	10,2	133 mm	87 mm	10	40
HT6D894	10,5	133 mm	87 mm	10	40
HT6D895	11,0	142 mm	94 mm	10	40
HT6D896	11,5	142 mm	94 mm	10	40
HT6D897	12,0	151 mm	101 mm	10	40
HT6D898	12,5	151 mm	101 mm	10	40
HT6D899	13,0	151 mm	101 mm	10	40

DE Metallbohrer EN Masonry drill bit FR Pack de forets à métaux ES Paquete de brocas para metal HR Svrdala za metal HU Fúrószer fémhez RO Burghii pentru metal BG Свердло за метал



Folder	Ø	Length	Flute Length	Box	Box
HT6D103	1,0	34 mm	12 mm	1	100
HT6D104	1,5	40 mm	18 mm	1	100
HT6D105	2,0	49 mm	24 mm	1	100
HT6D108	2,5	57 mm	30 mm	1	100
HT6D109	3,0	61 mm	33 mm	1	100
HT6D111	3,2	65 mm	36 mm	1	80
HT6D112	3,5	70 mm	39 mm	1	80
HT6D114	4,0	75 mm	43 mm	1	80
HT6D116	4,2	75 mm	43 mm	1	80
HT6D117	4,5	80 mm	47 mm	1	80
HT6D119	5,0	86 mm	52 mm	1	80

Folder	Ø	Length	Flute Length	Box	Box
HT6D122	5,5	93 mm	57 mm	1	60
HT6D123	6,0	93 mm	57 mm	1	60
HT6D126	6,5	101 mm	63 mm	1	60
HT6D127	7,0	109 mm	69 mm	1	60
HT6D129	8,0	117 mm	75 mm	1	60
HT6D132	9,0	125 mm	81 mm	1	40
HT6D134	10,0	133 mm	87 mm	1	40
HT6D137	11,0	142 mm	94 mm	1	40
HT6D139	12,0	151 mm	101 mm	1	40
HT6D141	13,0	151 mm	101 mm	1	40

DE Metallbohrer mit Sechskantschaft EN Metal drill bit set FR Pack de forets à métaux ES Paquete de brocas para metal HR Set svrdala za metal HU Fúrószer készlet fémhez RO Set de burghii pentru metal BG Комплект свердела за бетон

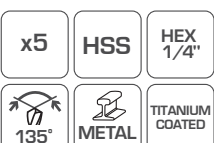

Folder	Ø	Length	Flute Length	Box	Box
HT6D180	4,0	95 mm	43 mm	10	100
	5,0	106 mm	52 mm		
	6,0	113 mm	57 mm		
	8,0	117 mm	75 mm		
	10,0	133 mm	87 mm		

DE Mehrfasenbohrer EN Subland step drill bit FR Foret à bois à étages ES Broca para madera de etapas HR Dvostupanjsko svrdlo HU Lépcsős fúró RO Burghii cu trepte BG свердело двустепенно



Folder	Ø	Length	Flute Length	Box	Box
HT6D330	6,5/9,5 mm	85 mm	42 mm	10	200

DE De Bohrer für Glas und Keramikfliesen EN Glass and tile drill bit FR Foret pour verre et céramique ES Broca para vidrio y cerámica HR Svrđala za staklo i keramičke pločice HU Üveg és csempefűró szár RO Burghii pentru sticla si faianta BG сверло двустепенно



	□	∅	↔	▢	📦
HT6D084		4,0	65 mm	50	200
HT6D085		5,0	68 mm	50	200
HT6D086		6,0	72 mm	50	200
HT6D088		8,0	80 mm	50	200
HT6D090		10,0	90 mm	50	200



DE Stufenbohrer EN Step drill FR Mèche progressive ES Broca escalonada HR Bitovi bušilice za koračno bušenje HU Lépcsős fűrók RO Burghie în trepte BG Конусно сверло за ламарина



	□	∅	▢	📦
HT6D321		4-12 mm	10	100
HT6D322		4-20 mm	10	100
HT6D323		4-32 mm	10	100

DE Stufenbohrer-Set EN Step drill set FR Jeu de forets étagés ES Juego de brocas escalonadas HR Bitovi bušilice za koračno bušenje HU Lépcsős fűrók RO Burghie în trepte BG Комплект конусно сверло за ламарина

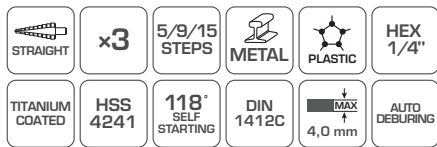

	□	∅	▢	📦
HT6D325		4-12 mm, 4-20 mm, 4-32 mm	10	50

DE Holzbohrer EN Wood drill bit FR Foret à bois ES Broca para madera HR Svrđala za drvo HU Fafűró RO Burghii pentru lemn BG Средло за дърво

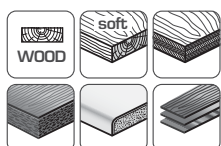

	□	∅	↔	▢	📦
HT6D523		3,0	60 mm	60	240
HT6D524		4,0	70 mm	60	240
HT6D525		5,0	85 mm	60	240
HT6D526		6,0	90 mm	60	240
HT6D527		7,0	105 mm	60	240
HT6D528		8,0	110 mm	60	240
HT6D530		10,0	120 mm	60	240

DE Bohrer Sah EN Drill saw bits set FR Pack de forets HSS-TiN multimatériaux ES Paquete de brocas con sierra para múltiples materiales HR Set svrdala- pila HU Fafűró-maró szár RO Burghii pentru taiere si gaurire BG Комплект свердла - пили



	□	∅	↔	↔	▢	📦
HT6D336		5,0 mm		73 mm		
		6,0 mm	84 mm	84 mm	40	160
		8,0 mm	92 mm	92 mm		

DE Stufenbohrer EN Step drill FR Mèche progressive ES Broca escalonada HR Bitovi bušilice za koračno bušenje HU Lépcsős fűrók RO Burghie în trepte BG Конусно сверло за ламарина

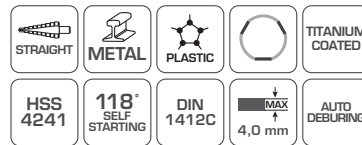

	□	∅	▢	📦
HT6D324		4-39 mm	10	50

DE Spiral-Stufenbohrer EN Step drill spiral FR Foret étagé ES Broca escalonada HR Bitovi spiralne bušilice za koračno bušenje HU Spirális lépcsős fűrók RO Burghie în trepte spiralete BG Конусно сверло спирален канал

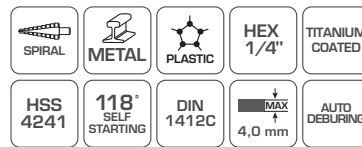

	□	∅	▢	📦
HT6D326		4-32 mm	10	100

DE Holzbohrer EN Wood drill bit FR Mèche bois plate ES Broca de pala para madera HR Svrđala za drvo HU Fafűró RO Burghii pentru lemn BG Плоско сверло



	□	∅	↔	▢	📦
HT7D110		10	152 mm	50	200
HT7D112		12	152 mm	50	200
HT7D114		14	152 mm	50	200
HT7D116		16	152 mm	50	200
HT7D118		18	152 mm	50	200
HT7D120		20	152 mm	50	200
HT7D122		22	152 mm	50	200
HT7D124		24	152 mm	50	200
HT7D125		25	152 mm	50	200
HT7D128		28	152 mm	50	200
HT7D130		30	152 mm	50	200
HT7D132		32	152 mm	50	200
HT7D135		35	152 mm	50	200
HT7D138		38	152 mm	50	200
HT7D140		40	152 mm	50	200



DE Holz-Drillbohrer **EN** Auger drill bit **FR** Foret à bois à pointe de centrage **ES** Broca para madera con punta **HR** Spiralna svrdala za drvo **HU** Fafuró **RO** Burghii pentru lemn **BG** Свредло спирално за дърво

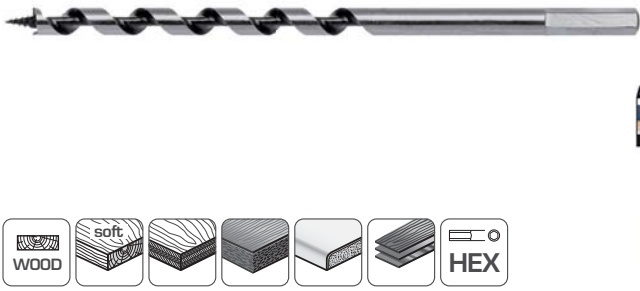

	□	∅	←→	←→	⊞	⊞
HT6D541	6,0	250 mm	180 mm	50	200	
HT6D543	8,0	250 mm	180 mm	50	200	
HT6D544	8,0	400 mm	310 mm	50	200	
HT6D545	10,0	250 mm	180 mm	50	100	
HT6D546	10,0	400 mm	310 mm	25	100	
HT6D547	12,0	250 mm	180 mm	50	100	
HT6D548	12,0	400 mm	310 mm	25	100	
HT6D549	14,0	250 mm	180 mm	50	100	
HT6D550	14,0	400 mm	310 mm	25	50	

	□	∅	←→	←→	⊞	⊞
HT6D551	16,0	250 mm	180 mm	25	100	
HT6D552	16,0	400 mm	310 mm	25	50	
HT6D553	18,0	250 mm	180 mm	25	50	
HT6D554	18,0	400 mm	310 mm	25	50	
HT6D555	20,0	250 mm	180 mm	25	50	
HT6D556	20,0	400 mm	310 mm	25	50	
HT6D557	22,0	250 mm	180 mm	25	50	
HT6D558	22,0	400 mm	310 mm	25	50	

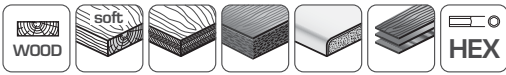

DE Verlängerung **EN** Extension **FR** Adaptateur pour Mèche bois plate **ES** Prolongador para brocas de pala **HR** Produžetak za lopatična svrdala **HU** Fafuró toldó **RO** Extensie pentru burghii **BG** Удължител за плоско свредло

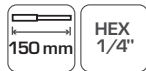

□	∅	←→	←→	⊞	⊞
HT7D158	150 mm	50	200		

DE Forstnerbohrer **EN** Forstner bit **FR** Fraise à bois d'encastrement **ES** Brocas Forstner bit para madera **HR** Cilindrična glodala **HU** Pánthely maró **RO** Capete de frezare pentru balamale **BG** Фрез за дърво



□	∅	←→	←→	⊞	⊞
HT6D310	15	93,5 mm	8 mm	10	100
HT6D312	20	93,5 mm	8 mm	10	100
HT6D314	25	93,5 mm	8 mm	10	100
HT6D316	26	93,5 mm	8 mm	10	100
HT6D317	30	93,5 mm	8 mm	10	100
HT6D320	35	93,5 mm	10 mm	10	100

DE Gewindebohrer-Schneideisen Satz **EN** Tap and die set **FR** Jeu d'outils de filetage **ES** Juegos de herramientas roscadoras **HR** Nit rezači **HU** Menetfúró vagy menetvágó szerszám **RO** Scule de tarodat sau filetat **BG** Резачки конци

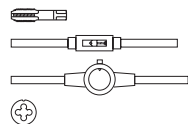

M3x0.5 M8x1.25
M4x0.7 M10x1.5
M5x0.8 M12x1.75
M6x1.0 NPT27x1/8
M7x1.0



□	∅	←→	←→	⊞	⊞
HT3B580	M3-M12	1	10		

DE Holzbohrer mit Sechskantschaft **EN** Hex shank stubby drill bit **FR** Foret tronqué à queue hexagonale **ES** Broca para madera con base hexagonal **HR** Svrdala za drvo **HU** Fafuró **RO** Burghii pentru lemn **BG** Свредло за дърво



□	∅	←→	←→	⊞	⊞
HT6D344	4,0 mm	60 mm	35 mm	50	250
HT6D345	5,0 mm	60 mm	35 mm	50	250
HT6D346	6,0 mm	60 mm	35 mm	50	250
HT6D348	8,0 mm	60 mm	35 mm	50	250

DE Versenkbohrer **EN** Countersink drill bit **FR** Foret à bois étagé **ES** Broca escalonada para madera **HR** Svrdla za potvrđivače **HU** Marófúró **RO** Burghii cu trepte **BG** Средла за конфирмат



□	∅	←→	←→	⊞	⊞
HT6D504	4,5 mm	90 mm	50 mm	10	250
HT6D505	5,0 mm	90 mm	50 mm	10	250

DE Einschnitt Gewindebohrer Satz **EN** Set of screw-taps and drills, 15 pcs. **FR** Robinet et jeu de matrice **ES** Set de terrajas de roscar y brocas **HR** Set slavina i svrdla **HU** Csapok és fúrók készlete **RO** Set de robineti si burghie **BG** Комплект кранчета и бормашини



M3x0.5
M4x0.7
M5x0.8
M6x 1.0
M8x1.25
M10x1.5
M12x1.75
M12x1.75
∅ 2.5 mm
∅ 3.3 mm
∅ 4.2 mm
∅ 5.0 mm
∅ 6.8 mm
∅ 8.5 mm
∅ 10.2 mm



□	∅	←→	←→	⊞	⊞
HT3B581	M3-M12	1	20		

DE Gewindeschneidwerkzeuge EN Tap and die set FR Jeux d'outils de filetage ES Juegos de herramientas roscadoras HR Nit rezači HU Menetfúró vagy menetvágó szerszám RO Scule de tarodat sau filetat BG Резачки конци

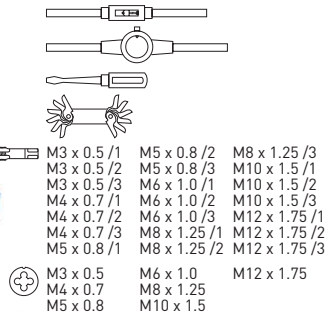
M3 x 0.5 /1 M5 x 0.8 /2 M8 x 1.25 /3
 M3 x 0.5 /2 M5 x 0.8 /3 M10 x 1.5 /1
 M3 x 0.5 /3 M6 x 1.0 /1 M10 x 1.5 /2
 M4 x 0.7 /1 M6 x 1.0 /2 M10 x 1.5 /3
 M4 x 0.7 /2 M6 x 1.0 /3 M12 x 1.75 /1
 M4 x 0.7 /3 M8 x 1.25 /1 M12 x 1.75 /2
 M5 x 0.8 /1 M8 x 1.25 /2 M12 x 1.75 /3

M3 x 0.5 M6 x 1.0 M12 x 1.75
 M4 x 0.7 M8 x 1.25
 M5 x 0.8 M10 x 1.5

HSS M3-M12 x32

HT3B582	M3-M12	1	10
---------	--------	---	----

DE Adapter für Lochsagen EN Bi-metal hole saw mandrel FR Foret pilote pour scie-cloche ES Broca de guía de sierra de perforación HR Adapteri za bimetalne krune za bušenje HU Bi-metál lyukfúró adapter fúrószárral RO Adaptor bi-metal pentru burghii cu ferastrau BG Адаптер за боркорона



HSS HEX 7/16"

HT6D462	14-30 mm	10	100
HT6D463	32-152 mm	10	100

DE Bimetal-Lochsagen EN Bi-metal hole saw FR Scie-cloche bi-métal ES Sierra bimetalica de perforación HR Bimetalne krune za bušenje HU Lyukfűrész fúrófejek RO Burghie cu ferastrau pentru gaurire BG Биметална боркорона



M42 STEEL 8% COBALT BiMetal 4-6 TPI METAL INOX WOOD PLASTIC Cu AI CAST IRON 38 mm

HT6D404	20 mm	10	100
HT6D406	22 mm	10	100
HT6D408	25 mm	10	100
HT6D410	29 mm	10	100
HT6D412	32 mm	10	100
HT6D414	35 mm	10	100
HT6D416	38 mm	10	100
HT6D417	40 mm	10	100
HT6D420	44 mm	10	100
HT6D424	51 mm	10	50
HT6D426	54 mm	10	50
HT6D429	57 mm	10	50
HT6D431	60 mm	10	50
HT6D433	64 mm	10	50
HT6D435	67 mm	10	50
HT6D436	68 mm	10	50
HT6D437	70 mm	10	50
HT6D438	73 mm	10	50
HT6D439	76 mm	5	50
HT6D440	79 mm	5	50
HT6D441	83 mm	5	50
HT6D442	86 mm	5	50
HT6D445	95 mm	5	20
HT6D447	102 mm	5	20
HT6D448	105 mm	5	20
HT6D450	111 mm	5	10
HT6D452	121 mm	5	10
HT6D453	127 mm	5	10
HT6D455	140 mm	5	10
HT6D466	80 mm	5	50

DE Diamant Lochsäge EN Diamond hole saw FR couronne diamantée ES Broca de corona cabeza diamante HR Dijamantne krune za bušenje HU Gyémánt koronafúrófej RO Carote diamantate BG Диамантена боркорона



HT7D270	6 mm	1	300
HT7D272	8 mm	1	300
HT7D274	10 mm	1	300
HT7D276	12 mm	1	300
HT7D278	14 mm	1	300
HT7D280	20 mm	1	100
HT7D282	25 mm	1	100
HT7D284	28 mm	1	100
HT7D285	30 mm	1	100
HT7D286	35 mm	1	100
HT7D290	55 mm	1	50
HT7D294	68 mm	1	50
HT7D296	75 mm	1	50

BRAZED DIAMOND DRY DIAMOND M14

DE Diamant Lochsäge EN Diamond hole saw FR Scie trépan diamant ES Broca de corona con cabeza de diamante HR Dijamantne krune za bušenje HU Gyémánt koronafúrófej RO Carote diamantate BG Диамантена боркорона



HT7D306	6 mm	36	360	HT7D338	38 mm	8	80
HT7D308	8 mm	36	360	HT7D340	40 mm	8	80
HT7D310	10 mm	36	360	HT7D344	44 mm	8	80
HT7D312	12 mm	36	360	HT7D350	50 mm	4	40
HT7D314	14 mm	24	240	HT7D353	53 mm	4	40
HT7D318	18 mm	24	240	HT7D360	60 mm	4	40
HT7D322	22 mm	24	240	HT7D365	65 mm	4	40
HT7D325	25 mm	12	120	HT7D367	67 mm	4	40
HT7D332	32 mm	8	80	HT7D373	73 mm	4	40
HT7D335	35 mm	8	80	HT7D383	83 mm	5	20

DIAMOND HEX

DE Diamanttrennscheiben unsegmentiert EN Diamond blade FR Disque diamant à jante continue ES Disco de diamante con borde continuo HR Dijamantni disk Super Thin, za univerzalne rezove HU Szuper-vékony gyémánt vágókorong, univerzális vágáshoz RO Disc super subtire pentru taieri universale BG Диамантен диск



HT6D701	115 mm	1,4 mm	1,4 mm	22,2 mm	50	100
HT6D702	125 mm	1,6 mm	7 mm	22,2 mm	50	100
HT6D703	180 mm	1,8 mm	7,5 mm	25,4 mm	1	50
HT6D706	230 mm	1,9 mm	7 mm	22,2 mm	1	25

SUPER THIN C max: 13.300 min⁻¹ EN 13236 GRANITE CERAMICS

DE Diamant-Trennscheibe EN Diamond blade FR Disque diamant extra-fin à jante continue ES Disco de diamante ultrafino con borde continuo HR Dijamantni disk Super Thin, za univerzalne rezove HU Szuper-vékony gyémánt vágókorong, univerzális vágáshoz RO Disc super subtire pentru taieri universale BG Диамантен диск



HT6D711	115 mm	1,3 mm	22,2 mm	50	100
HT6D712	125 mm	1,4 mm	22,2 mm	50	100
HT6D716	230 mm	2,0 mm	22,2 mm	1	25

SUPER THIN C max: 13.300 min⁻¹ GRANITE CERAMICS

DE Diamant-Trennscheibe EN Diamond blade FR Lame diamantée pour carreaux de céramique ES Disco de diamante HR Dijamantni disk, za rezanje pločica HU Gyémánt vágókorong, csempé vágásához RO Disc diamantat pentru taierea faietei BG Диамантен диск



EN 12236
SUPER SLIM
GRANITE CERAMICS

	□	∅	⊥	⊥	⊙	📦
HT6D721	115 mm	1,2 mm	22,2 mm		max: 13,300 min ⁻¹	50 100
HT6D722	125 mm	1,2 mm	22,2 mm		max: 12,000 min ⁻¹	50 100

DE Lasergeschweißte Diamantschneidsegmente EN Diamond blade FR Disque diamant Laser segmenté ES Disco de diamante segmentado mediante láser HR Dijamantni disk, za rezanje pločica HU Gyémánt vágókorong, csempé vágásához RO Disc diamantat pentru taierea faietei BG Диамантен диск



⊙ max:
13.300 min⁻¹
EN 12236
LASER WELDED
CONCRETE ASPHALT

	□	∅	⊥	⊥	⊙	📦
HT6D742	125 mm	2,2 mm	22,2 mm		50	100
HT6D746	230 mm	2,2 mm	22,2 mm		1	25

DE Diamantklinge EN Diamond blade FR Disque diamanté ES Disco de corte de diamante HR Dijamantni disk, za rezanje betona i asfalta HU Gyémánt vágókorong, csempé vágásához RO Disc diamantat pentru taiere, segmentata BG Диамантен диск



⊙ max:
5.500 min⁻¹
EN 13236
LASER WELDED
CONCRETE ASPHALT

	□	∅	⊥	⊥	⊙	📦
HT6D748	350 mm	3,2 mm	25,4 mm		1	10

DE Diamantscheibe zum Schleifen EN Diamond blade FR Disque diamant béton ES Disco de diamante para cemento HR Dijamantni disk, za brušenje betona HU Gyémánt vágókorong, beton vágásához RO Discuri diamantate pentru taierea betonului BG Диамантен диск

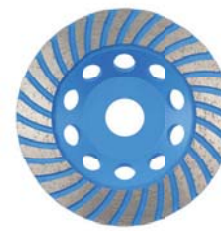

TURBO
⊙ max:
12.250 min⁻¹
FOR GRINDING
CONCRETE

	□	∅	⊥	⊥	⊙	📦
HT6D992	125 mm	5 mm	22,2 mm		1	25

DE Korundscheiben zum Metallschneiden EN Grinding wheel for metal and inox FR Disque à ébarber au corindon pour le métal ES Disco de corindón para desbarbado de metal HR Korundski disk za rezanje metala i inoxa HU Csiszoló korong, univerzális RO Disc pentru polizoare, universal BG Абразивни дискове за рязане на метал и inox



STEEL INOX
⊙ max:
12,250 /min
Vmax.
80m/s
FLAT

	□	∅	⊥	⊥	⊙	📦
HT6D601	115 mm	1,0 mm	22,23 mm		1	25
HT6D602	125 mm	1,0 mm	22,23 mm		1	25
HT6D604	230 mm	1,9 mm	22,23 mm		1	25
HT6D616	125 mm	0,8 mm	22,23 mm		1	25

DE Trennscheibe für Metall Inox EN Metal and inox cutting discs FR Lame de scie pour métaux ES Disco cortador para metal HR Metalni disk za rezanje HU Vágókorong fémhez RO Disc debitat metale BG Диск за рязане на метал и inox



STEEL INOX
⊙ max:
12,250 /min
Vmax.
80m/s
FLAT

	□	∅	⊥	⊥	⊙	📦
HT6D630	115 mm	1,0 mm	22,23 mm		1	400
HT6D631	125 mm	1,0mm	22,23mm		1	400
HT6D632	125mm	1,6mm	22,23mm		1	400
HT6D633	180mm	1,6mm	22,23mm		1	200
HT6D634	230mm	1,9mm	22,23mm		1	120

DE Metall-Schleif-scheibe EN Metal grinding discs FR Disque de polissage pour métaux ES Disco cortador para metal HR Metalni disk za brušenje HU Vágókorong fémhez RO Disc pt. șlefuit metal BG Диск за шлайфане на метал



STEEL
⊙ max:
13.300 min⁻¹
Vmax.
80m/s
DEPRESSED

	□	∅	⊥	⊥	⊙	📦
HT6D635	115 mm	6,0 mm	22,23 mm		1	100
HT6D636	125 mm	6,0 mm	22,23 mm		1	100
HT6D638	230 mm	6,8 mm	22,23 mm		1	40

DE Korundscheibe für Nirostähle EN Grinding wheel for inox FR Disque à ébarber au corindon pour l'inox ES Disco de corindón para desbarbado de acero inoxidable HR Korundski disk za rezanje inoxa HU Csiszoló korong acélhoz RO Disc pentru polizoare, pentru otel BG Абразивни дискове за рязане на inox



INOX
⊙ max:
12,250 /min
Vmax.
80m/s
FLAT

	□	∅	⊥	⊥	⊙	📦
HT6D606	125 mm	1,0 mm	22,23 mm		1	25

DE Korundscheibe zum Kupfer EN Grinding wheel for non-ferrous metal FR Disque à ébarber au corindon pour alu et métaux non ferreux ES Disco de corindón para desbarbado de aluminio y metales no férricos HR Korundski disk za rezanje bakra, aluminija i obojenih metala HU Csiszoló korong rézhez, alumíniumhoz, vasmentes fémekhez RO Disc pentru polizoare, pentru cupru, aluminiu și metale neferoase BG Диск за цветни метали



Cu Al	C n: 12,250 /min	Vmax. 80m/s		HT6D640	125 mm	1,6 mm	22,23 mm	1	25
----------	------------------------	----------------	--	---------	--------	--------	----------	---	----

DE Stichsägeblatt für schnelle Holzschritte EN Jig saw blade, fast wood cut FR Lame de scie sauteuse, pour des coupes rapides du bois ES List ubodne pile za brzo rezanje drva HR List ubodne pile za brzo rezanje drva HU Dekopírfűrész fűrészlap fa gyors vágásához RO Pânză de fierăstrău pentru tăierea rapidă a lemnului BG Нож за прободен трион за сухо дърво



Festool, De Walt, Kress, AEG, Black & Decker, Bosch, Makita, Hitach, Hilti, Milwaukee

SK5	x5	FAST CUT	STRAIGHT CUT	6 TPI	T-type	teeth shape	soft	HT6D651	75x100 mm	100	400
-----	----	----------	--------------	-------	--------	-------------	------	---------	-----------	-----	-----

DE Stichsägeblätter für schnellen Schnitt EN Jig saw blades, fast cut FR Pack de lames de scie sauteuse pour bois ES Paquete de hojas de sierra de calar para madera HR Listovi za ubodne pile, za brze rezove HU Dekopírfűrészlap, gyorsvágó RO Panze fierăstraie verticale, taiere rapidă BG Нож за прободен трион за дързо рязане



x2	CrV	FAST CUT	6 TPI	T-type	min 8mm	max 100mm	soft	hard	HT6D654-2	110 x 132 mm	25	250
----	-----	----------	-------	--------	---------	-----------	------	------	-----------	--------------	----	-----

DE Stichsägeblatt für gebogene Holzschritte EN Jig saw blade, curved wood cut FR Lame de scie sauteuse, pour des coupes courbes du bois ES List ubodne pile za krivolinijsko rezanje drva HR List ubodne pile za krivolinijsko rezanje drva HU Dekopírfűrész fűrészlap fa íves vonalú vágásához RO Pânză de fierăstrău pentru tăierea curbată a lemnului BG Нож за прободен трион за криво рязане на дърво



Festool, De Walt, Kress, AEG, Black & Decker, Bosch, Makita, Hitach, Hilti, Milwaukee

HCS 65Mn	CURVE CUT	x5	12 TPI	T-type	teeth shape	soft	min 1.5 mm	max 3.5 mm	HT6D657	50 x 76 mm	100	400
----------	-----------	----	--------	--------	-------------	------	------------	------------	---------	------------	-----	-----

DE Stichsägeblätter für schnellen Schnitt EN Jig saw blades, fast cut FR Pack de lames de scie sauteuse pour bois ES Paquete de hojas de sierra de calar para madera HR Listovi za ubodne pile, za brze rezove HU Dekopírfűrészlap, gyorsvágó RO Panze fierăstraie verticale, taiere rapidă BG Нож за прободен трион за дързо рязане



x2	CrV	FAST CUT	6 TPI	T-type	min 5 mm	max 60 mm	soft	HT6D650-2	75 x 100 mm	25	250
----	-----	----------	-------	--------	----------	-----------	------	-----------	-------------	----	-----

DE Stichsägeblatt für schnelle Holzschritte EN Jig saw blade, fast wood cut FR Lame de scie sauteuse, pour des coupes rapides du bois ES List ubodne pile za brzo rezanje drva HR List ubodne pile za brzo rezanje drva HU Dekopírfűrész fűrészlap fa gyors vágásához RO Pânză de fierăstrău pentru tăierea rapidă a lemnului BG Нож за прободен трион за сухо дърво



Festool, De Walt, Kress, AEG, Black & Decker, Bosch, Makita, Hitach, Hilti, Milwaukee

HCS 65Mn	x5	FAST CUT	9 TPI	T-type	teeth shape	soft	HT6D653	100 x 126 mm	100	400
----------	----	----------	-------	--------	-------------	------	---------	--------------	-----	-----

DE Stichsägeblätter für sauberen Schnitt EN Jig saw blades, clean cut FR Pack de lames de scie sauteuse pour bois ES Paquete de hojas de sierra de calar para madera HR Listovi za ubodne pile, za čiste rezove HU Dekopírfűrészlap, sima vágásfelülettel vágó RO Panze fierăstraie verticale, taiere curată BG Нож за прободен трион за дързо рязане



x2	CrV	CLEAN CUT	10 TPI	T-type	min 3mm	max 40mm	soft	HT6D656-2	75 x 100 mm	25	250
----	-----	-----------	--------	--------	---------	----------	------	-----------	-------------	----	-----

DE Stichsägeblatt für schnelle und gebogene Holzschritte EN Jig saw blade, fast curved wood cut FR Lame de scie sauteuse, pour des coupes courbes rapides du bois ES List ubodne pile za brzo krivolinijsko rezanje drvu HR List ubodne pile za brzo krivolinijsko rezanje drvu HU Dekopírfűrész fűrészlap fa gyors íves vonalú vágásához RO Pânză de fierăstrău pentru tăierea curbată rapidă a lemnului BG Нож за прободен трион за бързо криво рязане на дърво



Festool, De Walt, Kress, AEG, Black & Decker, Bosch, Makita, Hitach, Hilti, Milwaukee

HCS 65Mn	FAST CUT	CURVE CUT	x5	6 TPI	T-type	teeth shape	soft	min 3mm	max 40mm	HT6D659	75 x 100 mm	100	400
----------	----------	-----------	----	-------	--------	-------------	------	---------	----------	---------	-------------	-----	-----



DE Sticksägeblatt für saubere Holzschnitte **EN** Jig saw blades, clean cut **FR** Pack de lames de scie sauteuse pour bois **ES** Paquete de hojas de sierra de calar para madera **HR** Listovi za ubodne pile, za čiste ravnolinijske rezove **HU** Dekopír fűrészlap, sima vágásfelületű vágással egyenes vágáshoz **RO** Panze fierastrăie verticale, taiere curată în linie dreaptă **BG** Лист за ръчна ножовка за прецизно рязане на право



x2 CrV CLEAN CUT T-type

12 TPI min 3mm max 60mm soft

HT6D660-2	75 x 100 mm	25	250
-----------	-------------	----	-----

DE Sticksägeblätter für präzisen Kurvenschnitt **EN** Jig saw blades, precision curved cut **FR** Pack de lames de scies sauteuses **ES** Paquete de hojas de sierra de calar **HR** Listovi za ubodne pile, za precizne krivolinijske rezove **HU** Dekopír fűrészlap, precíz és ívelt vágáshoz **RO** Panze fierastrăie verticale, taiere rapida si de precizie **BG** Нож за прободен трион за прецизно рязане на криво



x2 CrV CLEAN CUT CURVE CUT T-type

10 TPI min 4mm max 30mm soft hard

HT6D663-2	75 x 100 mm	25	250
-----------	-------------	----	-----

DE Sticksägeblatt für saubere Holzschnitte **EN** Jig saw blade, clean wood cut **FR** Lame de scie sauteuse, pour des coupes nettes du bois **ES** List ubodne pile za čiste rezove u drvu **HR** List ubodne pile za čiste rezove u drvu **HU** Dekopírfűrész fűrészlap fa tisztá vágásához **RO** Pânză de fierăstrău pentru tăierea curată a lemnului **BG** Нож за прободен трион за рязане на дърво



Festool, De Walt, Kress, AEG, Black & Decker, Bosch, Makita, Hitach, Hilti, Milwaukee

HCS 65Mn CLEAN CUT x5 10 TPI T-type

teeth shape soft hard

min 4mm max 30mm

HT6D666	75 x 100 mm	100	400
---------	-------------	-----	-----

DE Sticksägeblatt für saubere Holzschnitte **EN** Jig saw blade, clean wood cut **FR** Lame de scie sauteuse, pour des coupes nettes du bois **ES** List ubodne pile za čiste rezove u drvu **HR** List ubodne pile za čiste rezove u drvu **HU** Dekopírfűrész fűrészlap fa tisztá vágásához **RO** Pânză de fierăstrău pentru tăierea curată a lemnului **BG** Нож за прободен трион за рязане на дърво



Festool, De Walt, Kress, AEG, Black & Decker, Bosch, Makita, Hitach, Hilti, Milwaukee

HCS 65Mn CLEAN CUT x5 8 TPI T-type teeth shape soft hard

min 3mm max 60mm

HT6D668	90 x 116 mm	100	400
---------	-------------	-----	-----

DE Sticksägeblätter für sauberen Kurvenschnitt **EN** Jig saw blades, clean curved cut **FR** Pack de lames de scie sauteuse pour bois **ES** Paquete de hojas de sierra de calar para madera **HR** Listovi za ubodne pile, za čiste krivolinijske rezove **HU** Dekopír fűrészlap, sima vágásfelületű vágással ívelt vágásokhoz **RO** Panze fierastrăie verticale, taiere de precizie în linie curbata **BG** Нож за прободен трион за прецизно рязане на криво



x2 CrV CLEAN CUT CURVE CUT T-type

12 TPI min 3mm max 60mm soft

HT6D661-2	75 x 100 mm	25	250
-----------	-------------	----	-----

DE Sticksägeblatt für saubere Holzschnitte **EN** Jig saw blade, clean wood cut **FR** Lame de scie sauteuse, pour des coupes nettes du bois **ES** List ubodne pile za čiste rezove u drvu **HR** List ubodne pile za čiste rezove u drvu **HU** Dekopírfűrész fűrészlap fa tisztá vágásához **RO** Pânză de fierăstrău pentru tăierea curată a lemnului **BG** Нож за прободен трион за рязане на дърво



HCS 65Mn CLEAN CUT x5 10 TPI T-type teeth shape soft hard

min 4mm max 30mm

HT6D665	75 x 100 mm	100	400
---------	-------------	-----	-----

DE Sticksägeblatt für saubere Holzschnitte **EN** Jig saw blade, clean wood cut **FR** Lame de scie sauteuse, pour des coupes nettes du bois **ES** List ubodne pile za čiste rezove u drvu **HR** List ubodne pile za čiste rezove u drvu **HU** Dekopírfűrész fűrészlap fa tisztá vágásához **RO** Pânză de fierăstrău pentru tăierea curată a lemnului **BG** Нож за прободен трион за рязане на дърво



Festool, De Walt, Kress, AEG, Black & Decker, Bosch, Makita, Hitach, Hilti, Milwaukee

HCS 65Mn CLEAN CUT x5 6 TPI T-type teeth shape soft hard

min 4mm max 30mm

HT6D667	75 x 100 mm	100	400
---------	-------------	-----	-----

DE Sticksägeblätter zur optimalen Verarbeitung von Metall **EN** Jig saw blades set **FR** Pack de lames de scie sauteuse pour bois et métal **ES** Paquete de hojas de sierra de calar para madera y metal **HR** Set listova za ubodne pile **HU** Dekopír fűrészlap készlet **RO** Set de panze fierastrăie verticale **BG** Комплект ножчета за прободен трион



WOOD x3 METAL x2 FAST CUT CLEAN CUT CURVE CUT T-type

		mm	mm	mm	TPI		
HT6D690	HT6D650	75	100	8-60	6		
	HT6D660	75	100	3-60	12		
	HT6D668	50	75	2-20	20	25	500
	HT6D670	50	75	1,5-3	21		
	HT6D674	50	75	3-6	12		

DE Sticksägeblätter zum Schneiden enger Kurven EN Jig saw blades, extreme curved cut FR Pack de lames de scie sauteuse pour bois ES Paquete de hojas de sierra de calar para madera HR Listovi za ubodne pile za rezanje kroz oštre lukove HU Dekopír fűrészlap 115 mm, rendkívül ívelt vágásokhoz RO Panze fierastrai verticale 115 mm, taiere in linie extrem de curbata BG Нож за прободен трион за право рязане



x2 CrV EXTREME CURVE CUT 8-11 TPI T-type

min 3mm max 80mm soft hard

HT6D682-2	95 x 115 mm	25	250
-----------	-------------	----	-----

DE Sticksägeblatt für Metallschnitte EN Jig saw blade, metal cut FR Lame de scie sauteuse, pour couper le métal ES List ubodne pile za rezanje metala HR List ubodne pile za rezanje metala HU Dekopír fűrészlap fém vágásához RO Pânză de fierăstrău pentru tăierea metalelor BG Нож за прободен трион за метал



HSS STRAIGHT CUT x5 T-type

teeth shape

HT6D672	75 x 100 mm	100	400
---------	-------------	-----	-----

DE Sticksägeblätter für universelle Verwendung EN Jig saw blades, universal in use FR Pack de lames de scie sauteuse multimatériaux ES Paquete de 2 hojas de sierra de calar para multimaterial HR Listove za ubodne pile, univerzalna primjena HU Dekopír fűrészlap 132 mm, univerzális felhasználásra RO Panze fierastrai verticale 132 mm, taiere pentru scorpori universale BG Универсален нож за прободен трион



x2 BiMetal MULTI 10-14 TPI T-type

min 3mm max 100mm METAL AI Cu, Ni Zn soft hard

HT6D680-2	110 x 132 mm	25	250
-----------	--------------	----	-----

DE Säbelsägeblätter für Stahl und Inox EN Reciprocating saw blade FR Lame de scie alternative ES Hoja de sierra metal y acero inoxidable para sierras de calar HR List za sabljastu pilu HU Univerzális kardfűrész lap RO Panze fierastrai sabie BG Лист за ръчен трион



BiMetal 14 TPI STEEL

HT6D902	280 mm 300 mm 0,9 mm	20	100
---------	----------------------------	----	-----

DE Sticksägeblatt für Metallschnitte EN Jig saw blade, metal cut FR Lame de scie sauteuse, pour couper le métal ES List ubodne pile za rezanje metala HR List ubodne pile za rezanje metala HU Dekopír fűrészlap fém vágásához RO Pânză de fierăstrău pentru tăierea metalelor BG Нож за прободен трион за метал



Festool, De Walt, Kress, AEG, Black & Decker, Bosch, Makita, Hitach, Hilti, Milwaukee

HSS STRAIGHT CUT x5 12 TPI

T-type teeth shape

HT6D671	50 x 76 mm	100	400
---------	------------	-----	-----

DE Sticksägeblatt für Metallschnitte EN Jig saw blade, metal cut FR Lame de scie sauteuse, pour couper le métal ES List ubodne pile za rezanje metala HR List ubodne pile za rezanje metala HU Dekopír fűrészlap fém vágásához RO Pânză de fierăstrău pentru tăierea metalelor BG Нож за прободен трион за метал



Festool, De Walt, Kress, AEG, Black & Decker, Bosch, Makita, Hitach, Hilti, Milwaukee

HSS STRAIGHT CUT x5 21 TPI

T-type teeth shape

HT6D673	110 x 132 mm	100	400
---------	--------------	-----	-----

DE Säbelsägeblätter EN Reciprocating saw blade FR Lame de scie alternative ES Hoja para sierra de sable HR List za sabljastu pilu HU Univerzális kardfűrész lap RO Panze fierastrai sabie BG Лист за ръчен трион

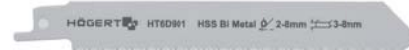

BiMetal 14 TPI STEEL

HT6D901	130 mm 150 mm 0,9 mm	20	100
---------	----------------------------	----	-----

DE Säbelsägeblätter für Holz EN Reciprocating saw blade FR Lame de scie alternative ES Hoja para sierra de sable HR List za sabljastu pilu HU Univerzális kardfűrész lap RO Panze fierastrai sabie BG Лист за ръчен трион





BiMetal 10-14 TPI METAL AI

soft hard

HT6D904	210 mm 230 mm 0,9 mm	20	100
---------	----------------------------	----	-----

DE Universal-Säbelsägeblätter EN Reciprocating saw blade FR Lame de scie alternative ES Hoja para sierra de sable HR List za sabljastu pilu HU Univerzális kardfűrész lap RO Panze fierastrăie sabie BG Лист за ръчен трион

BiMetal

6 TPI

METAL

soft

hard

Code	Length	Width	Quantity	Packaging
HT6D916	210 mm	1,57 mm	20	100
	230 mm			
	230 mm			

DE Fächerschleifmop mit Schaft EN Flap wheel with shaft FR Roue à lamelles abrasives sur tiges ES Rueda de aleta con eje HR Lepezasti brusni kolot HU Csiszolópapír korong fűrőgéphez RO Roata slefuire BG Шлайф барабан с опашка





Code	Size	Grain	Quantity	Packaging
HT8D001	40x20x6 mm	G40	10	250
HT8D002		G60	10	250
HT8D003		G80	10	250
HT8D004		G100	10	250
HT8D005		G120	10	250
HT8D006		G150	10	250
HT8D010	60x30x6 mm	G40	10	250
HT8D011		G60	10	250
HT8D012		G80	10	250
HT8D013		G100	10	250
HT8D014		G120	10	250
HT8D015		G150	10	250
HT8D020	80x40x6 mm	G40	5	100
HT8D021		G60	5	100
HT8D022		G80	5	100
HT8D023		G100	5	100
HT8D024		G120	5	100
HT8D025		G150	5	100

METAL

C_{max}
18.000 min⁻¹

DE Schleifpapier zum Gummiteller EN Abrasive disc FR Disque abrasif ES Disco abrasivo HR Brusni papir okrugli HU Csiszolópapír, kerek RO Foai slefuire BG Фибър диск

Code	Grain	Quantity	Packaging
HT8D100	G36	50	200
HT8D101	G40	50	200
HT8D102	G60	50	200
HT8D103	G80	50	200
HT8D104	G100	50	200
HT8D105	G120	50	200
HT8D106	G150	50	200
HT8D107	G180	50	200
HT8D108	G220	50	200



METAL
WOOD

125 mm

x5

VELCRO

DE Schleifpapier zum Gummiteller mit lochen EN Abrasive disc FR Disque abrasif trous ES Disco abrasivo con agujeros HR Brusni papir, okrugli, s rupicama HU Csiszolópapír sarokcsiszolóhoz, lyukacsos RO Foai slefuire gaurita BG Фибър диск

Code	Grain	Quantity	Packaging
HT8D130	G40	10	160
HT8D131	G60	10	160
HT8D132	G80	10	160
HT8D133	G100	10	160
HT8D134	G120	10	160
HT8D135	G150	10	160
HT8D136	G180	10	160
HT8D137	G220	10	160
HT8D138	G320	10	160

METAL
WOOD



150 mm

x5

15 holes

VELCRO

DE Universal-Säbelsägeblätter EN Reciprocating saw blade FR Lame de scie alternative ES Hoja para sierra de sable HR List za sabljastu pilu HU Univerzális kardfűrész lap RO Panze fierastrăie sabie BG Лист за ръчен трион

BiMetal

8% COBALT

6 TPI



METAL

soft

hard

Code	Length	Width	Quantity	Packaging
HT6D923	130 mm	0,9 mm	20	200
	150 mm			
	150 mm			

DE Fächerschleifscheibe - Gerade EN Flap disc depressed FR Disque à lamelles abrasives ES Disco de solapa deprimido HR Lamelni brusni disk HU Csiszoló korong RO Discuri abrazive BG Ламелни шайби





Code	Size	Grain	Quantity	Packaging
HT8D050	ø125 mm	22,4 mm	G36	10 100
HT8D051	ø125 mm	22,4 mm	G40	10 100
HT8D052	ø125 mm	22,4 mm	G60	10 100
HT8D053	ø125 mm	22,4 mm	G80	10 100
HT8D054	ø125 mm	22,4 mm	G100	10 100
HT8D055	ø125 mm	22,4 mm	G120	10 100

METAL

C_{max}
12.200 min⁻¹

DE Schleifpapier zum Gummiteller mit lochen EN Abrasive disc FR Disque abrasif trous ES Disco abrasivo con agujeros HR Brusni papir, okrugli, s rupicama HU Csiszolópapír sarokcsiszolóhoz, lyukacsos RO Foai slefuire gaurita BG Фибър диск

Code	Grain	Quantity	Packaging
HT8D120	G40	50	200
HT8D121	G60	50	200
HT8D122	G80	50	200
HT8D123	G100	50	200
HT8D124	G120	50	200
HT8D125	G150	50	200
HT8D126	G180	50	200
HT8D127	G220	50	200

METAL
WOOD

125 mm

x5

VELCRO

DE Schleifpapier zum Gummiteller mit lochen EN Abrasive disc FR Disque abrasif trous ES Disco abrasivo con agujeros HR Brusni papir, okrugli, s rupicama HU Csiszolópapír sarokcsiszolóhoz, lyukacsos RO Foai slefuire gaurita BG Фибър диск

Code	Grain	Quantity	Packaging
HT8D140	G60	10	160
HT8D141	G80	10	160
HT8D142	G100	10	160
HT8D143	G120	10	160
HT8D144	G150	10	160
HT8D145	G180	10	160
HT8D146	G220	10	160
HT8D147	G240	10	160
HT8D148	G280	10	160
HT8D149	G320	10	160
HT8D150	G400	10	160

PAINT

FILLER

150 mm

x5

15 holes

VELCRO

DE Vlies-Schleifscheibe EN Stripping disc FR Disque abrasif en fibre non-tissée ES Muela abrasiva no tejido para eliminación de óxido HR Poly grubi diskovi za čišćenje hrde HU Rostos rozsdáeltávolító csiszoló RO Roată de șlefuit nețesută pentru îndepărtarea ruginii BG Почистваща шайба на ръжда



METAL/ INOX/ WOOD/ PLASTIC	∅ 125mm	22,2 mm	C _{max} : 12500 min ⁻¹	80 m/s
-------------------------------------	------------	------------	---	-----------

HT8D190	20	80

DE Vlies-Schleifscheibe EN Stripping disc FR Disque abrasif en fibre non-tissée ES Muela abrasiva no tejido para eliminación de óxido HR Poly grubi diskovi za čišćenje hrde HU Rostos rozsdáeltávolító csiszoló RO Roată de șlefuit nețesută pentru îndepărtarea ruginii BG Почистваща шайба на ръжда



METAL/ INOX/ WOOD/ PLASTIC	∅ 100mm	∅ 6mm	C _{max} : 4500 min ⁻¹	80 m/s
-------------------------------------	------------	----------	--	-----------

HT8D195	10	40

DE Schlieflies EN Abrasive cloth FR Tampons abrasifs en fibre non tissée ES No Tejido Paño Abrasivo Almohadillas HR Netkani abrazivni jastučić HU Rostalapú Kézi Csiszolólapok-Fekete RO Tampoane abrazive din fibră nețesută BG Почистваща шайба



G400	x3	150x200 mm
------	----	---------------

HT8D200	1	120

DE Klett-Schleifteller mit Schaft EN Rubber backing pad FR Disque caoutchouc avec velcro ES Disco de goma para ancl con mandril HR Držać brusnog papira čičak HU Euro lemez élhez, tapadókoronggal RO Euro disc cu scai pt. polizor unghiular BG Подложка за фибър диск с велкро



∅ 125mm	M14	∅ 7mm	C _{max} : 10000 min ⁻¹
		HOOK FASTENER	

HT8D210	10	40

DE Topfbürste mit Schaft EN End brush with arbor FR Brosse conique tige ES Cepillo redondo con vástago HR Čeona četka s držačem HU Drótkorong, végkefével RO Perii de sarma tip oala pentru masini de gaurit BG Чашковидна телена четка с опашка



∅ 75 mm	∅ 0.3 mm	BRASS WIRE	MAX 4500 RPM
------------	-------------	---------------	--------------------

HT7D702	1	12

DE Topfbürste mit Schaft EN End brush with arbor FR Brosse conique tige ES Cepillo redondo con vástago HR Čeona četka s držačem HU Drótkorong, végkefével RO Perii de sarma tip oala pentru masini de gaurit BG Чашковидна телена четка с опашка



∅ 75 mm	∅ 0.3 mm	STAINLESS STEEL WIRE	MAX 4500 RPM
------------	-------------	----------------------------	--------------------

HT7D704	1	12

DE Topfbürste mit Schaft EN End brush with arbor FR Brosse conique tige ES Cepillo redondo con vástago HR Čeona četka s držačem HU Drótkorong, végkefével RO Perii de sarma tip oala pentru masini de gaurit BG Чашковидна телена четка с опашка



∅ 75 mm	∅ 0.5 mm	STAINLESS STEEL WIRE	MAX 12 500 RPM
------------	-------------	----------------------------	----------------------

HT7D706	1	12

DE Rundbürste mit Schaft EN Wheel brush with arbor FR Brosse circulaire tige ES Cepillo de disco con vástago HR Cirkularna četka s držačem HU Drótkorong, oldalkéfével RO Perii de sarma tip disc pentru masini de maurit BG Дискковидна телена четка с опашка



∅ 100 mm	∅ 0.3 mm	BRASS WIRE	MAX 4500 RPM
-------------	-------------	---------------	--------------------

HT7D712	1	12



DE Rundbürste mit Schaft EN Wheel brush with arbor FR Brosse circulaire tige
ES Cepillo de disco con vástago HR Cirkularna četka s držačem HU Drótkorong,
oldalkefével RO Perii de sarma tip disc pentru masini de maurit BG Дисквидна
телена четка с опашка



HT7D713	1	12

DE Rundbürste mit Schaft EN Wheel brush with arbor FR Brosse circulaire tige
ES Cepillo de disco con vástago HR Cirkularna četka s držačem HU Drótkorong,
oldalkefével RO Perii de sarma tip disc pentru masini de gaurit BG Дисквидна
телена четка с опашка

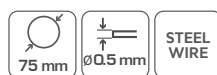

HT7D716	1	12

DE Kegelbürste mit Gewinde EN Knot wheel brush FR Brosse circulaire filetage
ES Cepillo de disco con rosca HR Cirkularna četka s navojem HU Drótkorong
sarokcsiszolóhoz, oldalkefével RO Perii de sarma conica pentru polizoare
unghiulare BG Дисквидна телена четка



HT7D722	1	6

DE Kegelbürste mit Gewinde EN Knot wheel brush FR Brosse circulaire filetage
ES Cepillo de disco con rosca HR Cirkularna četka s navojem HU Drótkorong
sarokcsiszolóhoz, oldalkefével RO Perii de sarma rasucita pentru polizoare
unghiulare BG Дисквидна телена четка



HT7D724	1	6

DE Kegelbürste mit Gewinde EN Knot wheel brush FR Brosse circulaire filetage
ES Cepillo de disco con rosca HR Čeona četka z navojem HU Drótkorong
sarokcsiszolóhoz, végkefével RO Perii de sarma tip alamt pentru polizoare
unghiulare BG Дисквидна телена четка



HT7D732	1	4

DE Kegelbürste mit Gewinde EN Knot wheel brush FR Brosse circulaire filetage
ES Cepillo de disco con rosca HR Čeona četka z navojem HU Drótkorong
sarokcsiszolóhoz, végkefével RO Perii de sarma rasucita pentru polizoare
unghiulare BG Дисквидна телена четка

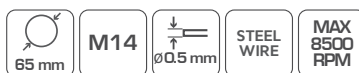

HT7D734	1	6

DE Kegelbürste mit Gewinde EN Knot wheel brush FR Brosse circulaire filetage
ES Cepillo de disco con rosca HR Čeona četka z navojem HU Drótkorong
sarokcsiszolóhoz, végkefével RO Perii de sarma rasucita pentru polizoare
unghiulare BG Дисквидна телена четка



HT7D738	1	4

DE Cuttermesser EN Snap-off blade knife FR Couteau à lame cassable ES Cuchillo con
hoja rompible HR Nož s oštricom za lomljenje HU Tapétavágó kés RO Cutter cu lama
fractionabila BG Макетен нож с чулещо се острие



HT4C603-D	9 mm	85 mm	24	288	
		21 mm	136 mm		

DE Cuttermesser **EN** Snap-off blade knife **FR** Couteau à lame cassable **ES** Cuchillo con hoja rompible **HR** Nož s oštricom za lomljenje **HU** Tapétavágó kés **RO** Cutter cu lama fractionabila **BG** Макетен нож с чупещо се острие



x2	SK5 STEEL	BLADE PULL 20 KG	ERGO GRIP							
HT4C604						18 mm	110 mm		12	144
						38 mm	165 mm			

DE Cuttermesser **EN** Snap-off blade knife **FR** Cutter à lame rétractable avec corps en zinc **ES** Cortador con cuchilla retráctil con cuerpo de zinc **HR** Nož s oštricom za lomljenje **HU** Tapétavágó kés **RO** Cutter cu lama fractionabila **BG** Макетен нож с чупещо се острие



SK5 STEEL	Zn Al	ERGO GRIP								
HT4C606						18 mm	110 mm		12	120
						40 mm	158 mm			

DE Messer mit gebrochener Klinge **EN** Knife with replaceable blade **FR** Cutter **ES** Cortatubos **HR** Nož s oštricom za lomljenje **HU** Tapétavágó kés **RO** Cutter cu lama fractionabila **BG** макетен нож с подменителни остриета



60 C STEEL	ERGO GRIP									
HT4C612						18 mm	110 mm		24	288
						23 mm	160 mm			

DE Messer mit gebrochener Klinge **EN** Knife with replaceable blade **FR** Cutter **ES** Cortatubos **HR** Nož s oštricom za lomljenje **HU** Tapétavágó kés **RO** Cutter cu lama fractionabila **BG** макетен нож с подменителни остриета



SK4 STEEL	LASER CUTTING BLADE	ANTI-RUST BLADE								
HT4C614						18 mm	110 mm		6	72
						40 mm	180 mm			

60 KG PULL-FORCE RESISTANCE

ERGO GRIP

DE Cuttermesser **EN** Snap-off blade knife **FR** Cutter à lame rétractable **ES** Cortador con cuchilla retráctil **HR** Nož s oštricom za lomljenje **HU** Tapétavágó kés **RO** Cutter cu lama fractionabila **BG** Макетен нож с чупещо се острие



SK5 STEEL	BLADE BLOCKING SYSTEM	BLADE PULL 20 KG	ERGO GRIP							
HT4C605						18 mm	100 mm		12	240
						45 mm	165 mm			

DE Cuttermesser **EN** Snap-off blade knife **FR** Couteau à lame sécable **ES** Cortador con cuchilla retráctil **HR** Nož s oštricom za lomljenje **HU** Tapétavágó kés **RO** Cutter cu lama fractionabila **BG** Макетен нож с чупещо се острие



SK4 STEEL	x5	BLADE PULL 20 KG	ABS TPR	ERGO GRIP							
HT4C607							18 mm	100 mm		12	96
							40 mm	165 mm			

DE Messer mit gebrochener Klinge **EN** Knife with replaceable blade **FR** Cutter **ES** Cortatubos **HR** Nož s oštricom za lomljenje **HU** Tapétavágó kés **RO** Cutter cu lama fractionabila **BG** макетен нож с подменителни остриета



SK4 STEEL	LASER CUTTING BLADE	ANTI-RUST BLADE	60 KG PULL-FORCE RESISTANCE	ERGO GRIP							
HT4C613							18 mm	110 mm		12	144
							40 mm	180 mm			

DE Trapezklingen Messer **EN** Trapezoidal blade knife **FR** Couteau à lame trapézoïdale **ES** Cuchillo con hoja trapezoidal **HR** Nož s trapeznom oštricom **HU** Trapéz pengés tapétavágó kés **RO** Cutter cu lama trapezoidală **BG** Нож макетен трапец



SK5 STEEL	x3	AUTO-RETRACTABLE	BELT CUT	EASY CHANGE	MULTI STOP	ERGO GRIP							
HT4C622									19 mm	61 mm		12	72
									175 mm	40 mm			



DE Trapezklingen-Klappmesser EN Trapezoidal blade knife FR Cutter à lame rétractable avec corps en aluminium ES Cortador con cuchilla retráctil con cuerpo de aluminio HR Nož s trapeznom oštricom HU Tapéztávágó kés RO Cutter cu lama trapezoidală BG Нож макетен трапец



- SK5 STEEL
- ALU
- BLADE BLOCKING SYSTEM
- FOLDABLE
- ERGO GRIP

		19 mm	6 mm		
HT4C623		40 mm	105 mm	12	96

DE Cuttermesser EN Snap-off blade knife FR Couteau à lame cassable ES Cuchillo con hoja rompible HR Nož s oštricom za lomljenje HU Tapéztávágó kés RO Cutter cu lama fractionabilă BG Макетен нож с чупещо се острие



- SK2H
- XTREME SHARP EDGE
- LASER CUTTING BLADE
- ANTI-RUST BLADE
- ABS
- LOCK-BUTTON

HT4C626	18 mm	30	240	

DE Cuttermesser EN Snap-off blade knife FR Couteau à lame cassable ES Cuchillo con hoja rompible HR Nož s oštricom za lomljenje HU Tapéztávágó kés RO Cutter cu lama fractionabilă BG Макетен нож с чупещо се острие



- SK2H
- XTREME SHARP EDGE
- 20 KG PULL-FORCE RESISTANCE
- LASER CUTTING BLADE
- ANTI-RUST BLADE
- AUTO-LOCK
- ABS
- METAL GUIDE BAR

HT4C628	9 mm	10	240	
HT4C629	18 mm	10	120	

DE Cuttermesser EN Snap-off blade knife FR Couteau à lame cassable ES Cuchillo con hoja rompible HR Nož s oštricom za lomljenje HU Tapéztávágó kés RO Cutter cu lama fractionabilă BG Малък макетен нож с чупещо се острие



- SK2H
- XTREME SHARP EDGE
- 20 KG PULL-FORCE RESISTANCE
- AUTO-RETRACTABLE
- LASER CUTTING BLADE
- ANTI-RUST BLADE
- AUTO-LOCK
- ABS
- METAL GUIDE BAR
- SL
- CAN OPENER

HT4C632	18 mm	10	120	

DE Messer mit Trapez Klinge EN Trapezoidal blade knife FR Couteau à lame trapézoïdale ES Cuchilla con hoja trapezoidală HR Nož s trapeznom oštricom HU Tapéztávágó kés RO Cutter cu lama trapezoidală BG Нож макетен трапец



- SK4 STEEL
- LASER CUTTING BLADE
- ANTI-RUST BLADE
- ALU
- ERGO GRIP
- 60 KG PULL-FORCE RESISTANCE

		19 mm	60 mm		
HT4C625		40 mm	175 mm	6	72

DE Cuttermesser EN Snap-off blade knife FR Couteau à lame cassable ES Cuchillo con hoja rompible HR Nož s oštricom za lomljenje HU Tapéztávágó kés RO Cutter cu lama fractionabilă BG Макетен нож с чупещо се острие



- SK5
- 60 KG PULL-FORCE RESISTANCE
- LASER CUTTING BLADE
- AUTO-LOCK
- PS + TPR
- METAL GUIDE BAR

HT4C627	18 mm	12	144	

DE Cuttermesser EN Snap-off blade knife FR Couteau à lame cassable ES Cuchillo con hoja rompible HR Nož s oštricom za lomljenje HU Tapéztávágó kés RO Cutter cu lama fractionabilă BG Малък макетен нож с чупещо се острие



- SK5
- x5
- LASER CUTTING BLADE
- 20 KG PULL-FORCE RESISTANCE
- AUTO-LOCK
- ABS + TPR
- METAL GUIDE BAR

HT4C630	18 mm	12	144	

DE Cuttermesser EN Snap-off blade knife FR Couteau à lame cassable ES Cuchillo con hoja rompible HR Nož s oštricom za lomljenje HU Tapéztávágó kés RO Cutter cu lama fractionabilă BG Малък макетен нож с чупещо се острие



- SK5
- 20 KG PULL-FORCE RESISTANCE
- LASER CUTTING BLADE
- AUTO-LOCK
- ALU
- METAL GUIDE BAR

HT4C635	9 mm	12	240	
HT4C636	18 mm	12	144	

DE Cuttermesser **EN** Snap-off blade knife **FR** Couteau à lame cassable **ES** Cuchillo con hoja rompible **HR** Nož s oštricom za lomljenje **HU** Tapétavágó kés **RO** Cutter cu lama fractionabila **BG** Малък макетен нож с чупещо се острие



SK2H	XTREME SHARP EDGE	60 KG PULL-FORCE RESISTANCE	LASER CUTTING BLADE
ANTI-RUST BLADE	AUTO-LOCK	ALU + TPR	METAL GUIDE BAR

HT4C637	18 mm	12	144

DE Cuttermesser **EN** Snap-off blade knife **FR** Couteau à lame cassable **ES** Cuchillo con hoja rompible **HR** Nož s oštricom za lomljenje **HU** Tapétavágó kés **RO** Cutter cu lama fractionabila **BG** Малък макетен нож с чупещо се острие



SK5	60 KG PULL-FORCE RESISTANCE	LASER CUTTING BLADE
AUTO-LOCK	ABS + TPR	METAL GUIDE BAR

HT4C638	25 mm	12	144

DE Trapezklingen Messer **EN** Trapezoidal blade knife **FR** Couteau à lame trapézoïdale **ES** Cuchillo con hoja trapezoidal **HR** Nož s trapeznom oštricom **HU** Trapéz pengés tapétavágó kés **RO** Cutter cu lama trapezoidală **BG** Нож макетен трапец



SK5	x4	ALU + TPR
EASY CHANGE	BELT CUT	90°/135°/180°

HT4C639	19 x 60 mm	12	144

DE Trapezklingen Messer **EN** Trapezoidal blade knife **FR** Couteau à lame trapézoïdale **ES** Cuchillo con hoja trapezoidal **HR** Nož s trapeznom oštricom **HU** Trapéz pengés tapétavágó kés **RO** Cutter cu lama trapezoidală **BG** Нож макетен трапец



x4	ALU	EASY CHANGE	MULTI STOP
-----------	------------	--------------------	-------------------

HT4C640	19 x 60 mm	12	144

DE Trapezklingen Messer **EN** Trapezoidal blade knife **FR** Couteau à lame trapézoïdale **ES** Cuchillo con hoja trapezoidal **HR** Nož s trapeznom oštricom **HU** Trapéz pengés tapétavágó kés **RO** Cutter cu lama trapezoidală **BG** Нож макетен трапец



SK5	x4	ALU + ABS
EASY CHANGE	BELT CUT	MULTI STOP

HT4C641	19 x 60 mm	12	72

DE Trapezklingen Messer **EN** Trapezoidal blade knife **FR** Couteau à lame trapézoïdale **ES** Cuchillo con hoja trapezoidal **HR** Nož s trapeznom oštricom **HU** Trapéz pengés tapétavágó kés **RO** Cutter cu lama trapezoidală **BG** Нож макетен трапец



SK2H	x4	XTREME SHARP EDGE	AUTO-RETRACTABLE
ALU + ABS	EASY CHANGE	BELT CUT	MULTI STOP

HT4C642	19 x 60 mm	12	72

DE Montagemesser **EN** Fitter's knife **FR** Couteau à lame repliable **ES** Cuchillo de hoja plegable **HR** Monterški nož **HU** Szerelő bicska **RO** Cutit cu varf ascuțit **BG** Монтърски нож



3Cr13 STEEL	WOODEN HANDLE
--------------------	----------------------

HT4C650	2,5 mm	210 mm	12	72

DE Montagemesser **EN** Fitter's knife **FR** Couteau à lame incurvée repliable **ES** Cuchillo plegable de hoja curva **HR** Monterški nož **HU** Szerelő bicska **RO** Cutit cu varf ascuțit **BG** Монтърски нож



3Cr13 STEEL	WOODEN HANDLE
--------------------	----------------------

HT4C651	2,5 mm	198 mm	12	72

DE Universalmesser EN Universal knife FR Couteau universel ES Cuchillo universal HR Univerzalni nož HU Szerelőkész RO Cutit de montare BG Универсален нож



STEINLESS STEEL BELT HANGER

HT4C652	100 mm	12	72

DE Abbrechklinge EN Snap-off blades FR Pack de lames sécables ES Paquete de cuchillas con tiras desechables HR Oštrice za lomljenje HU Penge tapétavágó késhez RO Lama fractionabila BG Острие резервно чупецо се



SK2H XTREME SHARP EDGE x10 LASER CUTTING BLADE ANTI-RUST BLADE

HT4C670	9 mm	10	120

DE Abbrechklinge EN Snap-off blades FR Pack de lames sécables ES Paquete de cuchillas con tiras desechables HR Oštrice za lomljenje HU Penge tapétavágó késhez RO Lama fractionabila BG Острие резервно чупецо се



18 mm SK4 STEEL x10 Xtreme Sharp Edge ANTI-RUST BLADE LASER CUTTING BLADE

HT4C664	18 mm	12	96

DE Abbrechklinge EN Snap-off blades FR Pack de lames sécables ES Paquete de cuchillas con tiras desechables HR Oštrice za lomljenje HU Penge tapétavágó késhez RO Lama fractionabila BG Острие резервно чупецо се



18 mm SK2 x10 LASER CUTTING BLADE

HT4C671	18 mm	10	120

DE Abbrechklinge EN Snap-off blades FR Pack de lames sécables ES Paquete de cuchillas con tiras desechables HR Oštrice za lomljenje HU Penge tapétavágó késhez RO Lama fractionabila BG Острие резервно чупецо се



9 mm SK5 STEEL x10

HT4C661	9 mm	24	576

DE Abbrechklinge EN Snap-off blades FR Pack de lames sécables ES Paquete de cuchillas con tiras desechables HR Oštrice za lomljenje HU Penge tapétavágó késhez RO Lama fractionabila BG Острие резервно чупецо се



18 mm SK5 STEEL x10

HT4C662	18 mm	24	288

DE Abbrechklinge EN Snap-off blades FR Pack de lames sécables ES Paquete de cuchillas con tiras desechables HR Oštrice za lomljenje HU Penge tapétavágó késhez RO Lama fractionabila BG Острие резервно чупецо се



18 mm SK4 STEEL x50

HT4C665	18 mm	8	32

DE Abbrechklinge EN Snap-off blades FR Pack de lames sécables ES Paquete de cuchillas con tiras desechables HR Oštrice za lomljenje HU Penge tapétavágó késhez RO Lama fractionabila BG Острие резервно чупецо се

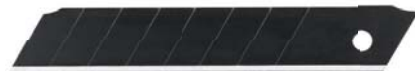

18 mm SK2H XTREME SHARP EDGE x10 LASER CUTTING BLADE ANTI-RUST BLADE

HT4C672	18 mm	10	120

DE Abbrechklinge EN Trapezoidal blades FR Pack de lames trapézoïdales ES Paquete de cuchillas trapezoidales HR Trapezne oštrice HU Trapéz penge tapétavágó késhez RO Lama trapezoidală BG Трапецовидно резервно острие



HT4C667	61 mm	0,45 mm	60	480

DE Abbrechklinge EN Snap-off blades FR Pack de lames sécables ES Paquete de cuchillas con tiras desechables HR Oštrice za lomljenje HU Penge tapétavágó késhez RO Lama fractionabila BG Острие резервно чупещо се



HT4C673	61 mm	0,6 mm	10	240

DE Hakenklingen EN Trapezoidal hook blades FR Pack de lames trapézoïdales à crochet ES Paquete de cuchillas trapezoidales con gancho HR Kukaste oštrice HU Trapéz kampós penge tapétavágóhoz RO Lama trapezoidală tip carlig BG Трапецовидно резервно острие



HT4C668	61 mm	0,45 mm	24	576

DE Abbrechklinge EN Trapezoidal blades FR Lames à trapézoïdales cassants ES Recambio para cuchilla trapezoidales negro HR Trapezne oštrice HU Trapéz penge tapétavágó késhez RO Lama trapezoidală BG Трапец резервно острие кука

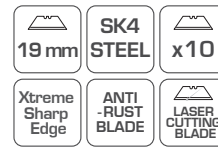

HT4C669	61 mm	0,45 mm	20	240

DE Abbrechklinge EN Snap-off blades FR Pack de lames sécables ES Paquete de cuchillas con tiras desechables HR Oštrice za lomljenje HU Penge tapétavágó késhez RO Lama fractionabila BG Острие резервно чупещо се

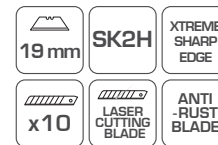
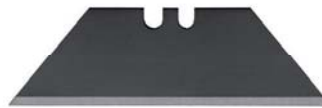

HT4C674	61 mm	0,6 mm	10	240



DE Anschlusswerkzeuge
EN Joining Tools
FR Outils De Connexion
ES Herramientas De Unión
HR Alati Za Spajanje
HU Csatlakoztató Eszközök
RO Instrumente De Îmbinare
BG Свързващи Инструменти





HT2C181

DE Schmelzkleberpistole EN Hot glue gun FR Pistolet à colle ES Pistola para pegamento HR Pištolj za ljepljenje HU Rudas ragasztópisztoly RO Pistol de lipire BG Пистолет за лепене



∅7 mm	20 W	230 V 50 Hz	10-20 g/min	CERAMIC HEATER	METAL TIP	HT2C101	220 g	12	48
-------	------	----------------	----------------	-------------------	--------------	---------	-------	----	----

DE Schmelzkleberpistole EN Hot glue gun FR Pistolet à colle ES Pistola de pegamento HR Pištolj za ljepljenje HU Rudas ragasztópisztoly RO Pistol de lipire BG Пистолет за лепене



∅11.2 mm	20(78)W	230 V 50 Hz	12-18 g/min			HT2C108	270 g	12	48
----------	---------	----------------	----------------	--	--	---------	-------	----	----

DE Leimpatronen EN Glue sticks FR Pack de bâtons de colle transparents ES Paquete de barras de pegamento transparente HR Kartuše s ljeplilom HU Ragasztórúd ragasztópisztolyhoz RO Lipici pentru pistol de lipire BG Силиконови пръчки за пистолет



∅11.2 mm	15PC	120-150°C				HT2C108	300 mm	5 kg	1	4
----------	------	-----------	--	--	--	---------	--------	------	---	---

DE Leimpatronen EN Glue sticks FR Baton de colle ES Pack de barras de pegamento HR Kartuše s ljeplilom HU Ragasztórúd ragasztópisztolyhoz RO Lipici pentru pistol de lipire BG Силиконови пръчки за пистолет



x12	∅11.2 mm	BLACK	18PC	120-150°C		HT2C138	250 mm	540 g	10	40
-----	----------	-------	------	-----------	--	---------	--------	-------	----	----

DE Schmelzkleberpistole EN Hot glue gun FR Pistolet à colle ES Pistola para pegamento HR Pištolj za ljepljenje HU Rudas ragasztópisztoly RO Pistol de lipire BG Пистолет за лепене



∅11.2 mm	100 W	230 V 50 Hz	13-30 g/min	CERAMIC HEATER	METAL TIP	HT2C107	400 g	10	30
----------	-------	----------------	----------------	-------------------	--------------	---------	-------	----	----

DE Leimpatronen EN Glue sticks FR Baton de colle ES Recambio para pistola de pegamento HR Kartuše s ljeplilom HU Ragasztórúd ragasztópisztolyhoz RO Lipici pentru pistol de lipire BG Силиконови пръчки за пистолет



∅11.2 mm	15PC	100-200°C				HT2C131	200 mm	1 kg	1	25
----------	------	-----------	--	--	--	---------	--------	------	---	----

DE Leimpatronen EN Glue sticks FR Pack de bâtons de colle transparents ES Paquete de 12 barras de pegamento transparente HR Kartuše s ljeplilom HU Ragasztórúd ragasztópisztolyhoz RO Lipici pentru pistol de lipire BG Силиконови пръчки за пистолет



x12	∅11.2 mm	18PC	120-150°C			HT2C137	250 mm	540 g	10	40
-----	----------	------	-----------	--	--	---------	--------	-------	----	----

DE Leimpatronen EN Glue sticks FR Baton de colle ES Recambio para pistola de pegamento HR Kartuše s ljeplilom HU Ragasztórúd ragasztópisztolyhoz RO Lipici pentru pistol de lipire BG Силиконови пръчки за пистолет



x10	∅7 mm	15PC	100-200°C			HT2C141	200 mm	110 g	1	150
-----	-------	------	-----------	--	--	---------	--------	-------	---	-----

DE Handtacker EN Staple gun FR Pistolet agrafeur ES Grapadora industrial HR Ručna klamera HU Tűzőgép RO Capsator BG Ръчен телбод/такер



TYPE J/53

HT2C002	11,3 mm	4-14 mm	0,7 mm	20	40
---------	---------	---------	--------	----	----

DE Klammern J EN Staples, type J FR Pack de agrafes Type J ES Paquete de grapas tipo J HR Spajalnice J HU J tűzőgép karcsok RO Carpe J BG Скоби тип J

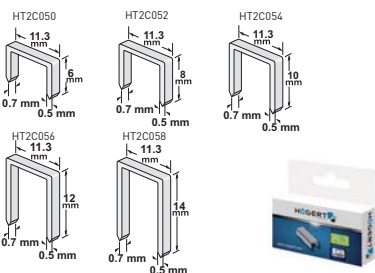

STEEL

x1000

TYPE J/53

HT2C050	11,3 mm	6 mm	0,7 mm	20	200
HT2C052	11,3 mm	8 mm	0,7 mm	20	200
HT2C054	11,3 mm	10 mm	0,7 mm	20	200
HT2C056	11,3 mm	12 mm	0,7 mm	20	200
HT2C058	11,3 mm	14 mm	0,7 mm	20	150

DE Blindnietzange EN Hand riveter FR Riveteuse réglable ES Remachadora con regulación HR Ručna zakovica, bočna HU Forgatható fejú kézi szegecselő RO Nitura de mana cu cap rotativ BG Ръчна нитачка странична



Ø	2,4 mm	3,2 mm	4,0 mm	4,8 mm
STEEL	✓	✓	✓	✓
STAINLESS STEEL	✓	✓	✓	✓
ALUMINIUM	✓	✓	✓	-

HT2C152	2,4 / 3,2 / 4,0 / 4,8 mm	5	20
---------	--------------------------	---	----

DE 2-Hand Blindnietzange EN Two-hand riveter FR Pince à riveter à deux mains ES Remachador a dos manos HR Ručna zakovica, s polugom HU Kézi szegecselő RO Nitura de mana cu parghie BG Ръчна нитачка лост



Ø	3,2 mm	4,0 mm	4,8 mm	6,0 mm	6,4 mm
ALUMINIUM	✓	✓	✓	✓	✓
STEEL	✓	✓	✓	✓	✓
STAINLESS STEEL	✓	✓	✓	✓	✓

HT2C156	3,2 / 4,0 / 4,8 / 6,0 / 6,4 mm	5	20
---------	--------------------------------	---	----

DE Handtacker EN Staple gun FR Agrafeuse-cloueuse ES Grapadora, clavadora HR Ručna klamera HU Tűzőgép RO Capsator BG Ръчен телбод/такер

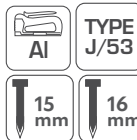

HT2C004	10,6 mm	6-16 mm	0,7 mm	12	24
	11,3 mm	4-14 mm	0,7 mm		

DE Nägel EN Nails FR Nails ES Clavos HR Čelični čavli HU Acél szegek RO Cuie de otel BG Пирони, тип J

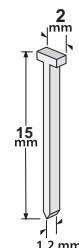

STEEL

x 500

TYPE J

T HEAD

HT2C059	15 x (→) 1 mm	20	200
---------	---------------	----	-----

DE 2-Hand Blindnietzange EN Two-hand riveter FR Pince à riveter à deux mains ES Remachador a dos manos HR Ručna zakovica, s polugom HU Kézi szegecselő RO Nitura de mana cu parghie BG Ръчна нитачка лост



Ø	2,4 mm	3,2 mm	4,0 mm	4,8 mm
STEEL	✓	✓	✓	✓
STAINLESS STEEL	✓	✓	✓	✓
ALUMINIUM	✓	✓	✓	✓

HT2C154	2,4 / 3,2 / 4,0 / 4,8 mm	5	20
---------	--------------------------	---	----

DE Nietmaschinen für Nietmuttern EN Screw nut gun FR Pince pour rivets filetés ES Remachadora para remaches HR Ručna zakovica, bočna HU Forgatható fejú kézi szegecselő RO Nitura de mana cu cap rotativ BG Нитачка за нит гайки



Ø	3,2 mm	4,0 mm	4,8 mm	6,0 mm	6,4 mm
ALUMINIUM	✓	✓	✓	✓	✓
STEEL	✓	✓	✓	✓	✓
STAINLESS STEEL	✓	✓	✓	✓	✓

HT2C156	3,2 / 4,0 / 4,8 / 6,0 / 6,4 mm	5	20
---------	--------------------------------	---	----



HT2C180	M3 / M4 / M5 / M6	5	20
---------	-------------------	---	----

DE Nietmaschinen für Nietmuttern EN Screw nut gun FR Pince pour rivets filetés
 ES Remachadora para remaches HR Ručna zakovica, s polugom HU Kézi szegecselő
 RO Nitura de mana cu parghie BG Нитачка за нит гайки



--	--	--

HT2C181	M3 / M4 / M5 / M6 / M8 / M10	1	10

DE LötKolben EN Soldering iron FR Fer à souder ES Soldador lápiz HR Štapne lemilice
 HU Forrasztópáka RO Fier de lipit BG Поялник



230V ~50Hz

HT2C301	30 W	380	4 mm	1	50
HT2C302	60 W	500	6 mm	1	50
HT2C303	80 W	530	7 mm	1	50
HT2C304	100 W	550	8 mm	1	50

DE Lötpistole EN Transformer soldering iron FR Fer à souder transformateur
 ES Soldador con transformador HR Pištolj lemelica HU Transzformátoros
 forrasztópáka RO Fier de lipit cu transformator BG Поялник индукционен



200 W	230V ~50Hz		70- 200°C		200- 350°C
	350- 500°C	12/48S	LED		

HT2C311	200 W	500	1	10

DE Nietpresse für Spreizdübel EN Riveter for pins FR Riveteuse pour épingles
 ES Remachadora de taco HR Ručna zakovica HU Kézi szegecselő RO Nitura de mana
 BG Нитачка за разширителни болтове



--	--	--

HT2C191	4 / 5 / 6 mm	5	20

DE Lötpistole EN Transformer soldering iron FR Fer à souder transformateur
 ES Soldador con transformador HR Pištolj lemelica HU Transzformátoros
 forrasztópáka RO Fier de lipit cu transformator BG Поялник индукционен



100 W	230V ~50Hz	500°C	12/48S	LED
-------	---------------	-------	--------	-----

HT2C310	100 W	500	1	6



HÖGERT
technik

DE Elektrowerkzeuge

EN Power Tools

FR Outils Électroportatifs

ES Herramientas Eléctricas

HR Električni Alati

HU Szerszámgépek

RO Scule Electrice

BG Электрически Инструменти





HÖGERT
Technik



DE Heissluftpistole EN Hot air gun FR Décapeur thermique ES Pistola de aire caliente HR Toplozračni pištolj HU Hőlégfúvó RO Suflanta de caldura BG Истолет за горещ въздух





2000 W	MAX 600°C	x4
0 1 2 300 l/min ~350°C	0 1 2 500 l/min ~600°C	230V ~50Hz

Folder	W	°C	Box	Box
HT2C550	2000 W	600°C	1	10

DE Heissluftpistole EN Hot air gun FR Décapeur thermique ES Pistola de aire caliente HR Toplozračni pištolj HU Hőlégfúvó RO Suflanta de caldura BG Истолет за горещ въздух





2000 W	MAX 600°C	x4
0 1 2 300 l/min 60-350°C	0 1 2 500 l/min 60-600°C	230V ~50Hz

Folder	W	°C	Box	Box
HT2C551	2000 W	600°C	1	10

DE Heissluftpistole EN Hot air gun FR Décapeur thermique ES Pistola de aire caliente HR Toplozračni pištolj HU Hőlégfúvó RO Suflanta de caldura BG Истолет за горещ въздух





2000 W	MAX 600°C	x4
0 1 2 50°C 250 l/min	0 1 2 100°C 550 l/min	280 l/min 50°C

Folder	W	°C	Box	Box
HT2C552	2000 W	600°C	1	5

DE Mini-Schleifer mit Stromanschluss EN Mini Grinder FR Outil multifonction à alimentation sur secteur ES Mini lijadora con cable HR Mini brusilica HU Mini köszörű RO Mini polizor cu fir BG Мини шлайф





170 W	8000 ~35000/min	3,2 mm
x5	ERGO GRIP	230V ~50Hz

Folder	RPM ⁻¹	Box	Box
HT2E100	8000-35000 rpm ⁻¹	1	8

DE Mini-Schleifer mit Stromanschluss EN Mini Grinder FR Outil multifonction à alimentation sur secteur ES Mini lijadora con cable HR Mini brusilica HU Mini szliflerka RO Mini polizor cu fir BG Мини шлайф





130 W	10000 ~32000/min	3,2 mm	x170
FLEXIBLE SHAFT	ERGO GRIP	230V ~50Hz	

Folder	RPM ⁻¹	Box	Box
HT2E101	10000-32000 rpm ⁻¹	1	8

DE Mini-Akkuschleifer EN Cordless mini Grinder FR Mini ponceuse sans fil ES Mini lijadora sin cable HR Aku mini brusilica HU Mini vezeték nélküli köszörű RO Mini polizor fara fir BG Акумулаторен мини шлайф





7,2 V	Li-Ion 900mA	5000 ~25000/min
3,2 mm	x24	LED LIGHT

Folder	RPM ⁻¹	Box	Box
HT2E105	5000-25000 rpm ⁻¹	1	10

DE Mini-Akkuschleifer EN Cordless mini Grinder FR Mini ponceuse sans fil ES Mini lijadora sin cable HR Aku mini brusilica HU Mini vezeték nélküli köszörő RO Mini polizor fara fir BG Акумулаторен мини шлайф



3,6 V	Li-Ion 600mA	5000 -10000/min
3,2 mm	x10	Mabuchi motor

	RPM ⁻¹		
HT2E106	5000/10000/15000 rpm ⁻¹	1	20

DE Graviergerät EN Engraving Tool FR Graveur ES Grabador eléctrico HR Brusilica za graviranje HU Gravírozó berendezés RO Instrument de gravat BG Устройство за гравирание



13 W	7200/min	FORCE x5	tungsten carbide tip x2	230V ~50Hz		RPM ⁻¹		
					HT2E130	7200 rpm ⁻¹	1	20

DE Ersatzzubehör-Set für Mini-Schleifer EN Mini Grinder Accessory Set FR Jeu d'accessoires de rechange pour outil multifonction ES Conjunto de accesorios de repuesto para mini lijadora HR Set rezervnog pribora za mini brusilice HU Mini köszörő tartozékkészlet RO Set de accesorii cu 145 buc BG Комплект аксесоари за мини шлайф



- Mandrels (2 x 3,2 mm, 1 x 2,3 mm) – 3 pcs
- Abrasive rolls (12,7 x 12,7 mm) – 8 pcs
- Abrasive rolls (6,3 x 12,7 mm) – 8 pcs
- Pointed abrasive discs (9,5 x 19 mm) – 1 pc
- Abrasive disc (25,4 x 6,3 mm) – 1 pc
- Abrasive disc (12,7 x 6,3 mm) – 4 pc
- Spanner – 1 pc
- Abrasive discs – 40 pcs
- Rubber disc (22 x 2,5 mm) – 1 pc
- Fabric disc (25 x 4,5 mm) – 1 pc
- Fibreglass cutting discs (32 x 1,2 mm) – 5 pcs
- Abrasive discs (20 x 3,2 mm) – 12 pcs
- Sanding stone – 1 pc
- Cutting wheels (24 x 0,4 mm) – 36 pcs
- Brushes (ø 3,2 mm) – 2 pcs
- Abrasive discs and mandrels (ø 3,2 mm) – 6 pcs
- Mandrels for abrasive discs (6,3 x 12,7 mm, 12,7 x 12,7 mm) – 2 pcs
- Mandrels for cutting discs (ø 3,2 mm) – 2 pcs
- Mandrels for polishing wheels (ø 3,2 mm) – 1 pc
- HSS cutter (ø 3,2 mm) – 1 pc
- Diamond drills (ø 3,2 mm) – 5 pcs
- HSS drills (2 x 2,3 mm, 2 x 3,2 mm) – 4 pcs

x145

HT2E115	1	20

DE Ersatzzubehör-Set für Mini-Schleifer EN Mini Grinder Accessory Set FR Jeu d'accessoires de rechange pour outil multifonction ES Conjunto de accesorios de repuesto para mini lijadora HR Set rezervnog pribora za mini brusilice HU Mini köszörő tartozékkészlet RO Set de accesorii cu 72 buc BG Комплект аксесоари за мини шлайф



- Abrasive rollers mandrel - 2 pcs
- Cutting wheel mandrel - 1 pc
- Polishing pad mandrel - 1 pc
- HSS cutter - 1 pc
- Diamond drills - 5 pcs
- Steel brushes - 2 pcs
- Grinding stones - 4 pcs
- Abrasive rollers - 4 pcs
- Handles - 2 pcs
- Pointed polishing disc - 1 pc
- Polishing disc - 10 pcs
- Polishing paste - 1 pc
- Abrasive discs - 38 pcs

x72

HT2E116	1	20

HÖGERT
technik

DE Zubehör Für Werkzeugkasten

EN Tool Storage

FR Stockage Des Outils

ES Almacenamiento De Herramientas

HR Pohrana Alata

HU Szerszámtárolók

RO Depozitarea Uneltelor

BG Съхраняване На Инструменти





HÖGERT
technik

DE Werkstattwagen EN Tool cabinet with opening protection FR Armoire d'atelier à tiroirs ES Armario de herramientas HR Ormar za radionice HU Műhelyszekrény, 6 fiókkal RO Dulap pentru atelier BG Шкаф за инструменти със защита за отваряне



DRAWER SELF-OPENING PROTECTION

4x75 mm 1x154 mm 1x233 mm low drawers MAX 15 kg

high drawers MAX 25 kg STEEL ABS EVA INSERTS

x4 5x1,25" x2 WITH BRAKES SELF CLOSING LOCK with 2 KEYS

HT7G045	708 x 459 x 977 mm	6	1	1

DE Werkzeugwagen EN Tool cabinet FR Servante d'atelier ES Carro portaherramienta HR Ormaric za alat HU Szerszám szekrény RO Cabinet de scule BG Шкаф за инструменти



4x75 mm 2x154 mm low drawers MAX 15 kg high drawers MAX 25 kg

DRAWER LOCK STEEL ABS x4 5x1,25"

x2 WITH BRAKES LOCK with 2 KEYS

HT7G046	760 x 460 x 910 mm	6	1	1

DE Werkzeugwagen EN Tool cabinet FR Servante d'atelier ES Armario para herramientas HR Dulap pentru atelier HU Szerszám szekrény RO Cabinet de scule BG Шкаф за инструменти



6x75 mm 1x154 mm low drawers MAX 15 kg high drawers MAX 25 kg

DRAWER LOCK STEEL ABS x4 5x1,25"

x2 WITH BRAKES LOCK with 2 KEYS

HT7G047	760 x 460 x 910 mm	7	1	1

DE Werkstattwagen EN Tool cabinet with opening protection FR Armoire d'atelier à tiroirs ES Armario de herramientas HR Ormar za radionice HU Műhelyszekrény, 6 fiókkal RO Dulap pentru atelier BG Шкаф за инструменти със защита за отваряне



DRAWER SELF-OPENING PROTECTION 5x75 mm 2x154 mm low drawers MAX 15 kg

high drawers MAX 25 kg STEEL ABS EVA INSERTS

x4 5x1,25" x2 WITH BRAKES SELF CLOSING LOCK with 2 KEYS

HT7G048	708 x 459 x 977 mm	7	1	1

DE Werkzeugschrank EN Tool cabinet with side door FR Armoire d'atelier à tiroirs avec porte latérale ES Carro de herramientas con cajones y puerta lateral HR Ormaric za alat HU Szerszám szekrény RO Cabinet de scule BG Шкаф за инструменти със странична вратичка



SIDE DOOR

6x50 mm 1x130 mm low drawers MAX 15 kg high drawers MAX 25 kg

DRAWER LOCK STEEL ABS EVA INSERTS

x4 5x1,25" x2 WITH BRAKES SELF CLOSING LOCK with 2 KEYS

HT7G049	700 x 455 x 900 mm	7	1	5

DE Werkzeugschrank, 171 Artikel EN Tool cabinet with accessories, 171 pcs FR Servante d'atelier 171 elements ES Armario para herramientas 171 elementos HR Ormaric za alat 171 kom. HU Szerszám szekrény 171 db RO Cabinet de scule 171 buc BG Шкаф за инструменти с аксесоари 171 бр.



HT7G120, HT7G121, HT7G122, HT7G124, HT7G125, HT7G127, HT7G128, HT7G130, HT7G132, HT7G133, HT7G134, HT7G137

x171 4x75 mm 2x154 mm low drawers MAX 15 kg

high drawers MAX 25 kg DRAWER LOCK STEEL ABS

x4 5x1,25" x2 WITH BRAKES LOCK with 2 KEYS

HT7G052	760 x 460 x 910 mm	6	1	1

DE Werkzeugwagen, 166 Artikel EN Tool cabinet, 166 pcs FR Servante d'atelier, 166 elements ES Armario para herramientas, 166 elementos HR Ormarić za alat 166 kom. HU Szerszámszekrény 166 db RO Cabinet de scule 166 buc BG Шкаф за инструменти с аксесоари 166 бр.



HT7G120, HT7G121, HT7G122, HT7G123, HT7G124, HT7G125, HT7G126, HT7G128, HT7G130, HT7G132, HT7G133, HT7G136

x166	6x75 mm	1x154 mm
low drawers MAX 15 kg	high drawers MAX 25 kg	DRAWER LOCK
STEEL	ABS	x4 5x1,25"
x2 WITH BRAKES	LOCK with 2 KEYS	

HT7G054	760 x 460 x 910 mm	7	1	1
---------	--------------------	---	---	---

DE Werkzeugwagen, 238 Artikel EN Tool cabinet, 238 pcs FR Servante d'atelier, 238 elements ES Armario para herramientas, 238 elementos HR Ormarić za alat 238 kom. HU Szerszámszekrény 238 db RO Cabinet de scule 238 buc BG Шкаф за инструменти с аксесоари 238 бр.



HT7G120, HT7G121, HT7G122, HT7G123, HT7G124, HT7G125, HT7G130, HT7G132, HT7G133, HT7G135, HT7G137, HT7G145, HT7G146, HT7G148, HT7G149

x238	6x75 mm	1x154 mm
low drawers MAX 15 kg	high drawers MAX 25 kg	DRAWER LOCK
STEEL	ABS	x4 5x1,25"
x2 WITH BRAKES	LOCK with 2 KEYS	

HT7G055	760 x 460 x 910 mm	7	1	1
---------	--------------------	---	---	---

DE Werkzeugschrank, 214 Artikel EN Tool cabinet, 214 pcs FR Servante d'atelier 214 elements ES Armario para herramientas 214 elementos HR Ormarić za alat 214 kom. HU Szerszámszekrény 214 db RO Cabinet de scule 214 buc BG Шкаф за инструменти с аксесоари 214 бр.



HT7G120, HT7G121, HT7G122, HT7G124, HT7G125, HT7G126, HT7G127, HT7G128, HT7G130, HT7G131, HT7G132, HT7G133, HT7G134, HT7G135, HT7G137

x214	4x75 mm	2x154 mm
low drawers MAX 15 kg	high drawers MAX 25 kg	DRAWER LOCK
STEEL	ABS	x4 5x1,25"
x2 WITH BRAKES	LOCK with 2 KEYS	

HT7G056	760 x 460 x 910 mm	6	1	1
---------	--------------------	---	---	---

DE Werkzeugschrank, 258 Artikel EN Tool cabinet, 258 pcs FR Servante d'atelier 258 elements ES Armario para herramientas 258 elementos HR Ormarić za alat 258 kom. HU Szerszámszekrény 258 db RO Cabinet de scule 258 buc BG Шкаф за инструменти с аксесоари 258 бр.



HT7G120, HT7G121, HT7G122, HT7G124, HT7G125, HT7G127, HT7G128, HT7G130, HT7G131, HT7G132, HT7G133, HT7G134, HT7G135, HT7G145, HT7G148

x252	6x75 mm	1x154 mm
low drawers MAX 15 kg	high drawers MAX 25 kg	DRAWER LOCK
STEEL	ABS	x4 5x1,25"
x2 WITH BRAKES	LOCK with 2 KEYS	

HT7G058	760 x 460 x 910 mm	7	1	1
---------	--------------------	---	---	---

DE Werkzeugschrank, 304 Artikel EN Tool cabinet, 304 pcs FR Servante d'atelier 304 elements ES Armario para herramientas 304 elementos HR Ormarić za alat 304 kom. HU Szerszámszekrény 304 db RO Cabinet de scule 304 buc BG Шкаф за инструменти с аксесоари 304 бр.



HT7G120, HT7G124, HT7G132, HT7G133, HT7G134, HT7G148, HT7G149, HT7G150, HT7G151

x304	6x60 mm	1x140 mm
THICKNESS 1,0 mm	65kg	MAX 25 kg
SOFT CLOSE	LOCK with 2 KEYS	
x4 5x1,25"	WOODEN WORKTOP 10 mm	STEEL

HT7G059	96,8 x 72 x 46 cm	7	1	1
---------	-------------------	---	---	---



DE Werkzeug EVA-Schaumstofffüllung für Werkzeugkasten EN EVA filling for drawers FR Doublure EVA pour tiroirs ES Rellenos EVA para cajones HR EVA ispunja za ladice HU EVA fiókbetét RO Umplere sertar EVA BG Вложка EVA за чекмеджета



HT7G160	545 x 400 x 2 mm	7-pack	18
---------	------------------	--------	----

x7	545x400 mm	2 mm	EVA
----	------------	------	-----

DE Werkzeugkasten EN Modular tool trolley FR Servante à outils ES Carrito de herramientas HR Ladičar za radionicu s kotačima HU Szerszámkocsi RO Cărucior de scule BG Модулна количка за инструменти



PL EN

3 modules	max 45 kg	1x20 kg 420x220x150 mm
2x5 kg 390x215x60 mm	1x15 kg 410x210x280 mm	
ALU HANDLE	x2	2 COMPARTMENTS
METAL LOCK		

HT7G080	52 x 32 x 72 cm	2	1	1
---------	-----------------	---	---	---

DE Mobile Kiste EN Mobile tool box FR Boîte à outils mobile ES Caja de herramientas móvil HR Mobilna kutija za alate HU Mobil szerszámosláda RO Cutie pentru instrumente mobile BG Мобилна кутия за инструменти



PROTECTION AGAINST DUST AND WATER	REINFORCED WALL STRUCTURE	DURABLE LOCKS	RUBBER COATED
INTERLOCKING SYSTEM	2 modules	max 30 kg	

HT7G081	450x360x640	2	1	1
---------	-------------	---	---	---

DE Werkzeugkasten mit 2 Schubladen EN 2-drawer tool box FR Boîte à outils à 2 tiroirs ES Caja de herramientas 2 cajones HR Kutija za alat HU 2 fiókos szerszámosláda RO Cutie cu 2 sertare BG Кутия за инструменти с 2 чекмеджета



UPPER STORAGE	METAL LOCK
STEEL	

HT7G074	21,8 x 25,5 x 52,0 cm	2	1	1
---------	-----------------------	---	---	---

DE Werkzeugkasten mit 4 Schubladen EN 4-drawer tool box FR Boîte à outils à 4 tiroirs ES Caja de herramientas 4 cajones HR Kutija za alat HU 4 fiókos szerszámosláda RO Cutie cu 4 sertare BG Кутия за инструменти с 4 чекмеджета



UPPER STORAGE	METAL LOCK
STEEL	

HT7G075	21,8 x 36,0 x 52,0 cm	4	1	1
---------	-----------------------	---	---	---

DE Werkzeugkasten aus Metall EN Metal tool box FR Boîte à outils métallique ES Caja de herramientas metálica HR Metalna kutija za alat HU Fém szerszám Doboz RO Cutie de scule metalice BG Метална кутия за инструменти



5 częściowa	max 50 kg	STEEL
0,6 mm		

HT7G077	45 x 20,5 x 20 cm	18"	5	1	1
---------	-------------------	-----	---	---	---

DE Werkzeugkasten aus Metall EN Metal tool box FR Boîte à outils métallique ES Caja de herramientas metálica HR Metalna kutija za alat HU Fém szerszám Doboz RO Cutie de scule metalice BG Метална кутия за инструменти



5 częściowa	max 70 kg	STEEL
0,8 mm		

HT7G072	55 x 20,5 x 29,5 cm	20"	5	1	1
---------	---------------------	-----	---	---	---

DE Werkzeugkasten aus Metall EN Metal tool box FR Boîte à outils métallique ES Caja de herramientas metálica HR Metalna kutija za alat HU Fém szerszámdoboz RO Cutie de scule metalice BG Метална кутия за инструменти



5 częściowe max 50 kg STEEL

0,6 mm

HT7G078	53 × 20,5 × 20 cm	21"	5	1 1

DE Hermetischer Werkzeugkasten EN Hermetic tool box FR Boîte à outils étanche ES Caja de herramientas hermética HR Hermetička kutija za alat HU Hermetikusan záró szerszámdoboz RO Cutie de instrumente ermetică BG Херметична кутия за инструменти



IP 55 PP EPDM

DECOMPRESSION VALVE 3-POINT HINGES CUBE SPONGE INSERT

HT7G010	270 × 246 × 124 mm	10,5"	1 12

DE Hermetischer Werkzeugkasten EN Hermetic tool box FR Boîte à outils étanche ES Caja de herramientas hermética HR Hermetička kutija za alat HU Hermetikusan záró szerszámdoboz RO Cutie de instrumente ermetică BG Херметична кутия за инструменти



IP 55 PP EPDM

DECOMPRESSION VALVE 3-POINT HINGES CUBE SPONGE INSERT

HT7G011	339 × 295 × 152 mm	14"	1 4

DE Hermetischer Werkzeugkasten EN Hermetic tool box FR Boîte à outils étanche ES Caja de herramientas hermética HR Hermetička kutija za alat HU Hermetikusan záró szerszámdoboz RO Cutie de instrumente ermetică BG Херметична кутия за инструменти



IP 55 PP EPDM

DECOMPRESSION VALVE 4-POINT HINGES CUBE SPONGE INSERT

HT7G012	460 × 365 × 176 mm	18,5"	1 2

DE Hermetischer Werkzeugkasten EN Hermetic tool box FR Boîte à outils étanche ES Caja de herramientas hermética HR Hermetička kutija za alat HU Hermetikusan záró szerszámdoboz RO Cutie de instrumente ermetică BG Херметична кутия за инструменти



IP 55 PP EPDM

DECOMPRESSION VALVE 3-POINT HINGES CUBE SPONGE INSERT

HT7G018	420 × 220 × 340 mm	16,5"	1 2

DE Werkzeugkasten EN Toolbox FR Boîte à outils vide ES Caja de herramientas vacía de pulgadas HR Kutija za alat HU Szerszámoszláda RO Trusa de scule BG Кутия за инструменти



max 12 kg 2x ORGANISERS REMOVABLE TOOL TRAY

PP ALU HANDLE

HT7G060	45 × 25 × 25 cm	18"	1 1

DE Werkzeugkasten EN Toolbox FR Boîte à outils vide ES Caja de herramientas vacía de pulgadas HR Kutija za alat HU Szerszámoszláda RO Trusa de scule BG Кутия за инструменти



HT7G061	470 x 256 x 238	18"	1 1

max 15 kg	ABS + ELASTOMER	REMOVABLE TOOL TRAY
POLYCARBONATE COVER	ALU HANDLE	

DE Werkzeugkasten EN Toolbox FR Boîte à outils vide ES Caja de herramientas vacía de pulgadas HR Kutija za alat HU Szerszámoszláda RO Trusa de scule BG Кутия за инструменти



HT7G063	540x278x269	22"	1 1

max 20 kg	ABS + ELASTOMER	REMOVABLE TOOL TRAY
POLYCARBONATE COVER	ALU HANDLE	

DE Werkzeugkasten EN Toolbox FR Boîte à outils vide ES Caja de herramientas vacía de pulgadas HR Kutija za alat HU Szerszámoszláda RO Trusa de scule BG Кутия за инструменти



HT7G066	586x296x305	25"	1 1

max 25 kg	ABS + ELASTOMER	REMOVABLE TOOL TRAY
POLYCARBONATE COVER	ALU HANDLE	

DE Werkzeugkasten EN Toolbox FR Boîte à outils vide ES Caja de herramientas vacía de pulgadas HR Kutija za alat HU Szerszámoszláda RO Trusa de scule BG Кутия за инструменти



HT7G064	55 x 28 x 28 cm	22"	1 1

max 22 kg	2x ORGANISERS	REMOVABLE TOOL TRAY
PP	ALU HANDLE	

DE Werkzeugkasten EN Toolbox FR Boîte à outils vide ES Caja de herramientas vacía de pulgadas HR Kutija za alat HU Szerszámoszláda RO Trusa de scule BG Кутия за инструменти



HT7G065	60 x 28,6 x 32,7 cm	25"	1 1

max 27 kg	2x ORGANISERS	REMOVABLE TOOL TRAY
PP	ALU HANDLE	

DE Sortimentskasten EN Storage organizer FR Boite de rangement ES Caja de almacenamiento HR Organizer HU Rendező RO Organizator BG Кутия органайзер



HT7G033	18 x 9 x 3,5 cm	3,5"	1 120

PP	6 PARTITIONS
----	--------------

DE Sortimentskasten EN Storage organizer FR Boite de rangement ES Caja de almacenamiento HR Organizer HU Rendező RO Organizator BG Кутия органайзер



HT7G034	20 x 16 x 3,5 mm	7,5"	1 64

PP 5 PARTITIONS

DE Sortimentskasten EN Storage organizer FR Boite de rangement ES Caja de almacenamiento HR Organizer HU Rendező RO Organizator BG Кутия органайзер



HT7G022	29 x 19,5 x 3,5 cm	12"	1 60

UP TO 22 PARTITIONS 15 DIVIDERS SECURED
ADJUSTABLE PARTITIONS PP

DE Sortimentskasten EN Storage organizer FR Boite de rangement ES Caja de almacenamiento HR Organizer HU Rendező RO Organizator BG Кутия органайзер



HT7G024	34,4 x 24,9 x 5 cm	14"	1 10

UP TO 20 PARTITIONS 15 DIVIDERS SECURED
ADJUSTABLE PARTITIONS PP

DE Sortimentskasten EN Storage organizer FR Boite de rangement ES Caja de almacenamiento HR Organizer HU Rendező RO Organizator BG Кутия органайзер



HT7G026	39,9 x 30,3 x 5 cm	16"	1 10

UP TO 30 PARTITIONS 15 DIVIDERS SECURED
ADJUSTABLE PARTITIONS PP

DE Maul-Ring-Schlüsselsatz EN Combination spanner set FR Jeu de clés mixtes ES Juego de llaves planas y de estrella HR Set viljuškasto-okastih ključeva HU Kombinált villáskulcs készlet RO Set de chei combinate BG Комплект комбиниран-гаечен ключ

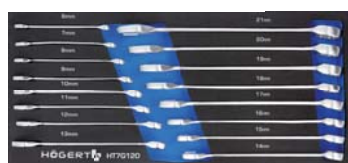

- HT1W406 (6 mm),
- HT1W407 (7 mm),
- HT1W408 (8 mm),
- HT1W409 (9 mm),
- HT1W410 (10 mm),
- HT1W411 (11 mm),
- HT1W412 (12 mm),
- HT1W413 (13 mm),
- HT1W414 (14 mm),
- HT1W415 (15 mm),
- HT1W416 (16 mm),
- HT1W417 (17 mm),
- HT1W418 (18 mm),
- HT1W419 (19 mm),
- HT1W420 (20 mm),
- HT1W421 (21 mm)

HT7G120	39,5 x 18 cm	1	5

x16 6-21 mm CrV EVA

DE Maul-Ring-Schlüsselsatz EN Combination spanner set FR Jeu de clés mixtes ES Juego de llaves planas y de estrella HR Set viljuškasto-okastih ključeva HU Kombinált villáskulcs készlet RO Set de chei combinate BG Комплект комбиниран-гаечен ключ



- HT1W422 (22 mm),
- HT1W424 (24 mm),
- HT1W427 (27 mm),
- HT1W428 (28 mm),
- HT1W430 (30 mm),
- HT1W432 (32 mm)

HT7G121	39,5 x 18 cm	1	5

x6 22-32 mm CrV EVA

DE Doppelschraubenschlüsselsatz EN Double open-end spanner set FR Jeu de clés polygonales ES Juego de llaves planas y de estrella HR Set ukošenih okastih ključeva HU Hajlított gyűrűs villáskulcsok RO Set de chei cu inel îndoit BG Комплект гаечни ключове

DE Doppelschraubenschlüsselsatz EN Double open-end spanner set FR Jeu de clés polygonales ES Juego de llaves planas y de estrella HR Set ukošenih okastih ključeva HU Hajlított gyűrűs villáskulcsok RO Set de chei cu inel îndoit BG Комплект гаечни ключове



HT1W541 (6 x 7 mm),
HT1W542 (8 x 9 mm),
HT1W544 (10 x 11 mm),
HT1W546 (12 x 13 mm),
HT1W548 (14 x 15 mm),
HT1W549 (16 x 17 mm),
HT1W551 (18 x 19 mm)



HT1W553 (20 x 22 mm),
HT1W554 (21 x 23 mm),
HT1W555 (24 x 27 mm),
HT1W551 (30 x 32 mm)

HT7G122	39,5 x 18 cm	1	5

x7	6-17 mm	CrV	EVA
----	---------	-----	-----

HT7G123	39,5 x 18 cm	1	5

x4	22-32 mm	CrV	EVA
----	----------	-----	-----

DE Bitsatz EN Bit set FR Jeu d'embouts de vissage ES Juego de puntas de destornillador HR Set bitova odvijača HU Csavarhúzó készlet RO Set de șurubelniță BG Комплект сменяеми накрайници за отвертки

DE Steckschlüsselsatz EN Sockets set FR Jeu de douilles avec adaptateurs ES Juego de llaves de vaso con adaptadores HR Set šesterokutnih nasadnih ključeva s adapterima HU Hatlapú foglalat adapterekkel RO Set de prize hexagonale cu adaptoare BG Комплект вложки с адаптери



HT1S404
 ● 30 mm: T20, T25, T30, T40, T45, T50, T55
 ● 75 mm: T20, T25, T30, T40, T45, T50, T55
 ● 30 mm: M5, M6, M8, M10, M12
 ● 75 mm: M5, M6, M8, M10, M12
 ● 30 mm: H4, H5, H6, H7, H8, H10, H12
 ● 75 mm: H4, H5, H6, H7, H8, H10, H12
 Bit holders for screwdriver bits:
 10 mm 3/8", 10 mm 1/2"



HT1A260 (10 mm),
HT1A261 (11 mm),
HT1A262 (12 mm),
HT1A263 (13 mm),
HT1A264 (14 mm),
HT1A265 (15 mm),
HT1A267 (17 mm),
HT1A269 (19 mm),
HT1A271 (21 mm),
HT1A272 (22 mm),
HT1A274 (24 mm),
HT1A783 (16 mm),
HT1A785 (21 mm),
HT1A773 (F1/2" x M3/8"),
HT1A774 (F1/2" x M3/4")

HT7G124	39,5 x 18 cm	1	10

x40	10mm	CrV	EVA
-----	------	-----	-----

HT7G125	39,5 x 18 cm	1	5

x14	1/2"	DEEP
CrV	EVA	

DE Steckschlüsselsatz mit Rathe EN Sockets set with ratchet FR Jeu de clés à cliquet, d'outils et de douilles ES Juego de herramientas con carraca HR Set alata s račnom HU Racsnis szerszámkészlet RO Set de instrumente cu clichet BG Комплект инструменти с тресчотка

DE Steckschlüsselsatz mit Rathe EN Sockets set with ratchet FR Jeu de clés à cliquet, d'outils et de douilles ES Juego de herramientas con carraca HR Set alata s račnom HU Racsnis szerszámkészlet RO Set de instrumente cu clichet BG Комплект инструменти с тресчотка



HT1A002 (4 mm), HT1A003 (4,5 mm),
HT1A004 (5 mm), HT1A005 (5,5 mm),
HT1A006 (6 mm), HT1A007 (7 mm),
HT1A008 (8 mm), HT1A009 (9 mm),
HT1A010 (10 mm), HT1A011 (11 mm),
HT1A012 (12 mm), HT1A013 (13 mm),
HT1A014 (14 mm),
HT1A771 (F3/8" x M1/4"),
HT1A772 (F3/8" x M1/2"), HT1A752 (1/4"),
HT1A701 (50 mm), HT1A703 (100 mm),
HT1A740 (150 mm), HT1A755 (1/4"),
HT1A744, HT1S203 (150 mm), HT1R324,
HT1S301 (PH1 - 25 mm),
HT1S302 (PH2 - 25 mm),
HT1S303 (PH3 - 25 mm),
HT1S361 (T10 - 25 mm),
HT1S362 (T15 - 25 mm),
HT1S363 (T20 - 25 mm),
HT1S364 (T25 - 25 mm),
HT1S366 (T30 - 25 mm),
HT1S367 (T40 - 25 mm),
HT1S359 (H3, H4 - 25 mm)



1/4": E5, E6, E7, E8
 3/8": E10, E12, E14, E16
 1/2": E10, E11, E12, E14, E16, E18, E20, E22, E24
 HT1A771 (F3/8" x M1/4"),
HT1A772 (F3/8" x M1/2"),
HT1A714 (3/8"),
HT1R328 (3/8")

HT7G126	39,5 x 18 cm	1	5

x34	1/4"	CrV	EVA
-----	------	-----	-----

HT7G127	39,5 x 18 cm	1	5

x21	1/4" 3/8" 1/2"	E-type
CrV	EVA	

DE Steckschlüsselsatz mit Ratche EN Sockets set with ratchet FR Jeu de clés à cliquet, d'outils et de douilles ES Juego de herramientas con carraca HR Set alata s račnom HU Racsnis szerszámkészlet RO Set de instrumente cu clichet BG Комплект инструменти с тресчотка

DE Schlag Steckschlüsselsatz EN Impact sockets set FR Jeu de douilles à percussion ES Juego de llaves de impacto HR Set udarnih nasadnih ključeva HU Hosszú dugókulcs készlet RO Set de prize lungi de impact BG Комплект ударни вложки



HT1A210 (10 mm), HT1A211 (11 mm), HT1A212 (12 mm), HT1A213 (13 mm), HT1A214 (14 mm), HT1A215 (15 mm), HT1A216 (16 mm), HT1A217 (17 mm), HT1A218 (18 mm), HT1A219 (19 mm), HT1A220 (20 mm), HT1A221 (21 mm), HT1A222 (22 mm), HT1A223 (23 mm), HT1A224 (24 mm), HT1A227 (27 mm), HT1A230 (30 mm), HT1A232 (32 mm), HT1A236 (36 mm), HT1R322 (1/2"), HT1A724 (1/2" 127 mm), HT1A727 (1/2" 254 mm), HT1A757 (1/2")



1/2": 10, 12, 13, 14, 15, 16, 17, 18, 19, 21, 22, 24, 27, 30, 32 mm

HT7G128	39,5 x 18 cm	1	5

x23	1/2"	CrV	EVA
-----	------	-----	-----

HT7G129	39,5 x 18 cm	1	5

x15	1/2"	DEEP
CrMo	EVA	

DE Zangesatz EN Pliers set FR Jeu de pinces ES Juego de alicates HR Set klijesta HU Fogó készlet RO Set de clești BG Комплект клещи

DE Zangesatz EN Retaining ring pliers set FR Jeu de pinces pour bague de retenue ES Juego de alicates circlip HR Set klijesta za pričvršne prstenove HU Gyűrűs kapcsoló HU Fogó készlet RO Cleste pentru inel BG Комплект клещи за зегерки



HT1P008 (180 mm), HT1P010 (160 mm), HT1P016 (160 mm), HT1P022 (160 mm)



HT1P141 (180 mm), HT1P142 (180 mm), HT1P143 (180 mm), HT1P144 (180 mm)

HT7G130	39,5 x 18 cm	1	10

x4	CrV	EVA
----	-----	-----

HT7G131	39,5 x 18 cm	1	10

x4	CrV	EVA
----	-----	-----

DE Schraubenziehersatz EN Screwdrivers set FR Jeu de tournevis plats ES Juego de destornilladores planos HR Set ravnih odvijača HU Lapos csavarhúzó készlet RO Set de șurubelnițe cu fante BG Комплект отвертки

DE Schraubenziehersatz EN PH Screwdrivers set FR Jeu de tournevis ES Juego de destornilladores HR Set odvijača HU PH Phillips csavarhúzó készlet RO Set de șurubelnițe PH Phillips BG Комплект отвертки



HT1S001 (3 x 75 mm), HT1S004 (4 x 100 mm), HT1S008 (5 x 100 mm), HT1S010 (6,5 x 38 mm), HT1S012 (6 x 100 mm), HT1S014 (6 x 150 mm), HT1S016 (8 x 150 mm)



HT1S020 (PH1 75 mm), HT1S023 (PH1 75 mm), HT1S024 (PH1 100 mm), HT1S028 (PH2 38 mm), HT1S029 (PH2 100 mm), HT1S032 (PH2 200 mm)

HT7G132	39,5 x 18 cm	1	5

x7	SL	S2	EVA
----	----	----	-----

HT7G133	39,5 x 18 cm	1	5

x6	PH/PZ	S2	EVA
----	-------	----	-----

DE Schraubendreher- und Inbusschlüssel-Satz EN Set of screwdrivers, HEX and TORX keys FR Jeu de tournevis et de clés Allen ES Juego de destornilladores, llaves hexagonales y TORX HR Set odvijača i Allen ključeva HU Csavarhúzók és hatlapú kulcsok RO Set de șurubelnițe și chei hexagonale BG Отвертка, комплект HEX и TORX ключове



HT1S066 (6 x 125 mm),
HT1S072 (PH2 125 mm),
HT1W804 (1,5 - 10 mm),
HT1W814 (T10 - T50)

				x20		
HT7G134	39,5 x 18 cm	1	10			

DE Werkzeugsatz EN Tool set FR Jeu de marteaux et de burins ES Juego de herramientas HR Set alata HU Szerszámkészlet RO Set de scule BG Комплект инструменти



HT3B005 (500 g),
HT3B721 (10 x 8 x 142 mm),
HT3B722 (13 x 10 x 150 mm),
HT3B728 (6 x 10 x 102 mm),
HT3B729 (8 x 11 x 115 mm)

				x5	500g
HT7G135	39,5 x 18 cm	1	1		

DE Werkzeugsatz EN Wrenches set FR Jeu de pinces et clé ES Juego de llaves HR Set ključeva HU Kulcs készlet RO Set de chei BG Комплект ключове



HT1P560 (250 mm),
HT1P562 (140 mm),
HT1P372 (250 mm)

				x3	EVA	
HT7G136	39,5 x 18 cm	1	1			

DE Schraubenziehersatz EN 1000 V slotted screwdrivers set FR Jeu de tournevis 1000V ES Juego de destornilladores 1000V HR Set odvijača 1000 V HU Szigetelt hornyos csavarhúzó RO Set de șurubelnițe cu fante izolate BG Комплект изолирани отвертки 1000 V и тестер за напрежение

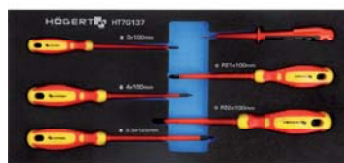

HTS960 (3 x 100 mm),
HT1S961 (4 x 100 mm),
HT1S962 (5,5 x 125 mm),
HT1S968 (PZ1 100 mm),
HT1S969 (PZ2 100 mm),
HT1S981

				x6	EVA	
HT7G137	39,5 x 18 cm	1	1	1000V		

DE Werkzeugsatz EN 1000 V tool set FR Jeu de pinces et tournevis 1000 V ES Juego de alicantes y destornilladores 1000V HR Set alata 1000 V HU Szigetelt szerszámkészlet RO Set de unelte izolate BG Изолирани отвертки 1000V комплект



HT1P903 (160 mm),
HT1P909 (160 mm),
HT1S968 (PZ1 100 mm),
HT1S969 (PZ2 100 mm),
HT1S981

				x5	EVA	
HT7G139	39,5 x 18 cm	1	1		1000V	

DE Werkzeugsatz EN Tool set FR Jeu d'outils ES Juego de herramientas HR Set alata HU Szerszámkészlet RO Set de scule BG Изолирани отвертки



HT1P903 (160 mm),
HTS960 (3 x 100 mm),
HT1S968 (PZ1 100 mm),
HT1S969 (PZ2 100 mm),
HT1P182,
HT1S981

				x6	EVA	
HT7G141	39,5 x 18 cm	1	1		1000V VDE	

DE Blindnietzange EN Riveter set with room for rivets FR Riveteuse ES Juego de remachadora y cajas para remaches HR Pištolj za slijepe zakovice HU Szegecselő RO Nituitoar BG Ръчна нитачка за нит гайки - комплект с нит гайки



HT2C152 + 4 blanks for rivets

HT7G142	39,5 x 18 cm	1	1

x1	EVA
----	-----

DE Werkzeugsatz EN Tool set FR Jeu d'outils ES Juego de herramientas HR Set alata HU Szerszámkészlet RO Set de scule BG Изолирани отвертки



HT1P612 (6-35 mm),
HT1P554 (250 mm),
HT1P520 (1")

HT7G144	39,5 x 18 cm	1	1

x3	EVA
----	-----

DE Werkzeugsatz EN Open-ended spanner set FR Jeu de clés plates ES Juego de llaves planas HR Set viljuškastih dvostranih ključeva HU Nyitott kulcskészlet RO Set de chei deschise BG Гаечен комплект

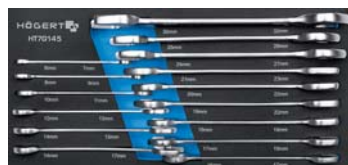

HT1W501 (6 x 7 mm),
HT1W502 (8 x 9 mm),
HT1W504 (10 x 11 mm),
HT1W506 (12 x 13 mm),
HT1W507 (13 x 17 mm),
HT1W508 (14 x 15 mm),
HT1W509 (16 x 17 mm),
HT1W510 (17 x 19 mm),
HT1W511 (18 x 19 mm),
HT1W512 (19 x 22 mm),
HT1W513 (20 x 22 mm),
HT1W514 (21 x 23 mm),
HT1W515 (24 x 27 mm),
HT1W516 (25 x 28 mm),
HT1W517 (30 x 32 mm)

HT7G145	39,5 x 18 cm	1	5

x15		DIN 3110	CrV	EVA
	15°			

DE Werkzeugsatz EN Combination spanner set with ratchet FR Jeu de clés mixtes à cliquet ES Juego de llaves combinadas HR Set viljuškasto-okastih ključeva s čegrtaljkom HU Lapos gyűrűs racsnis villáskulcs készlet RO Set de chei inel plat de cu clichet BG Комплект комбиниран-гаечен ключ с рачет

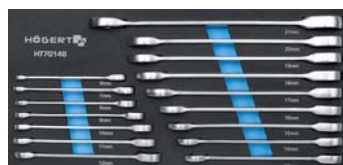

HT1R006 (6 mm),
HT1R007 (7 mm),
HT1R008 (8 mm),
HT1R009 (9 mm),
HT1R010 (10 mm),
HT1R011 (11 mm),
HT1R012 (12 mm),
HT1R013 (13 mm),
HT1R014 (14 mm),
HT1R015 (15 mm),
HT1R016 (16 mm),
HT1R017 (17 mm),
HT1R018 (18 mm),
HT1R019 (19 mm),
HT1R020 (20 mm),
HT1R021 (21 mm)

HT7G146	39,5 x 18 cm	1	5

x16			CrV	EVA
	15°	72T		

DE Werkzeugsatz EN Flat ring spanner set with articulated joint FR Jeu de clés mixtes avec un joint ES Juego de llaves combinadas HR Set viljuškasto-okastih ključeva s račnom HU Lapos gyűrűs csavar kulcs csuklóval RO Cheie inelară plată cu balamă BG Комплект гаечен ключ



HT1R048 (8 mm),
HT1R049 (9 mm),
HT1R050 (10 mm),
HT1R051 (11 mm),
HT1R052 (12 mm),
HT1R053 (13 mm),
HT1R054 (14 mm),
HT1R055 (15 mm),
HT1R056 (16 mm),
HT1R057 (17 mm),
HT1R058 (18 mm),
HT1R059 (19 mm),
HT1R060 (20 mm),
HT1R061 (21 mm)

HT7G147	39,5 x 18 cm	1	5

x14	12PT		
		15°	FLEXIBLE HEAD
	CrV	EVA	
72T			

DE Werkzeugsatz EN Toolset with ratchet FR Ensemble de 27 pièces avec clé à cliquet ES Juego de llaves fijas con carraca HR Set alata s čegrtaljkom HU Racsnis szerszámkészlet RO Set de scule cu clichet BG Комплект инструменти с тресчотка



HT1A208 (8 mm), HT1A209 (9 mm),
HT1A210 (10 mm), HT1A211 (11 mm),
HT1A212 (12 mm), HT1A213 (13 mm),
HT1A214 (14 mm), HT1A215 (15 mm),
HT1A216 (16 mm), HT1A217 (17 mm),
HT1A218 (18 mm), HT1A219 (19 mm),
HT1A221 (21 mm), HT1A222 (22 mm),
HT1A224 (24 mm), HT1A227 (27 mm),
HT1A230 (30 mm), HT1A232 (32 mm),
HT1A236 (36 mm), HT1A757 (1/2"),
HT1A727 (1/2", 254 mm),
HT1R322 (1/2"),
HT1A785 (1/2", 21 mm),
HT1A783 (1/2", 16 mm),
HT1A265 (15 mm),
HT1A267 (17 mm),
HT1A269 (19 mm)

HT7G149	39,5 x 18 cm	1	5

x27	1/2"		CrV	EVA
		72T		

DE Werkzeugsatz EN Tool set with ratchet FR Jeu de clés mixtes avec un joint ES Juego de llaves combinadas HR Set alata s čegrtaljkom HU Racsnis szerszámkészlet RO Set de scule cu clichet BG Комплект инструменти с тресчотка



- HT1A002 (4 mm), HT1A003 (4,5 mm), HT1A004 (5 mm), HT1A005 (5,5 mm), HT1A006 (6 mm), HT1A007 (7 mm), HT1A008 (8 mm), HT1A009 (9 mm), HT1A010 (10 mm), HT1A011 (11 mm), HT1A012 (12 mm), HT1A013 (13 mm), HT1A014 (14 mm), HT1A752 (1/4"), HT1A604 (E4), HT1A605 (E5), HT1A606 (E6), HT1A607 (E7), HT1A608 (E8), HT1A609 (E10), HT1A705 (1/4", 152,4 mm), HT1A740 (18/4", 150 mm),
- HT1R324 (1/4"), HT1S203 (1/4"), 1/4" bit sockets PZ3 (HT1S608), PZ2 (HT1S607), PZ1 (HT1S606), PH3 (HT1S603), PH2 (HT1S602), PH1 (HT1S601), T40 (HT1S648), T30 (HT1S647), T25 (HT1S645), T20 (HT1S644), T15 (HT1S643), T10 (HT1S642), T8 (HT1S640), SL4, SL5, SL7, H8 (HT1S628), H7 (HT1S627), H6 (HT1S626), H5 (HT1S625), H4 (HT1S624),
- H3 (HT1S623), HT1A744, deep sockets (1/4") HT1A052 (4 mm), HT1A053 (4,5 mm), HT1A054 (5 mm), HT1A055 (5,5 mm), HT1A056 (6 mm), HT1A057 (7 mm), HT1A058 (8 mm), HT1A059 (9 mm), HT1A060 (10 mm), HT1A061 (11 mm), HT1A062 (12 mm), HT1A063 (13 mm), HT1A064 (14 mm), HT1A755 (1/4", 35 mm), HT1A701 (1/4", 50,8 mm), HT1A703 (1/4", 101 mm)

HT7G148	39,5 x 18 cm	1	5

x63 1/4" 72T CrV EVA

DE Bitsatz EN Bit set FR Jeu d'embouts de vissage ES Juego de puntas de destornillador HR Set bitova odvijača HU Csavarhúzó készlet RO Set de șurubelniță BG Комплект сменями накрайници за отвертки



- HT1S201 (100 mm), HT1S203 (150 mm), HT1A752 (1/4"), 1/4" 65 mm, 3/8" 65 mm, 1/2" 75 mm, HT1S457 (8 mm), HT1S458 (10 mm), HT1S459 (12 mm), HT1S460 (13 mm), magnetic extension bit holder S2, HT1S439 (60 mm), magnetic bit holder with quick release, HT1S300 (PH0 25 mm), HT1S301 (PH1 25 mm), HT1S302 (PH2 25 mm), HT1S303 (PH3 25 mm),
- HT1S307 (PZ0 25 mm), HT1S314 (PZ1 25 mm), HT1S315 (PZ2 25 mm), HT1S316 (PZ3 25 mm), HT1S330 (SL4 25 mm), HT1S331 (SL5 25 mm), HT1S332 (SL6 25 mm), HT1S333 (SL8 25 mm), HT1S334 (TORX T8 25 mm), HT1S335 (TORX T9 25 mm), HT1S336 (TORX T10 25 mm), HT1S337 (TORX T15 25 mm), HT1S338 (TORX T20 25 mm), HT1S339 (TORX T25 25 mm), HT1S341 (TORX T30 25 mm), HT1S342 (TORX T40 25 mm), HT1S347 (HEX H3 25 mm), HT1S348 (HEX H4 25 mm), HT1S349 (HEX H5 25 mm),
- HT1S350 (HEX H6 25 mm), HT1S323 (PH0 50 mm), HT1S310 (PH1 50 mm), HT1S311 (PH2 50 mm), HT1S312 (PH3 50 mm), HT1S324 (PZ0 50 mm), HT1S318 (PZ1 50 mm), HT1S319 (PZ2 50 mm), HT1S321 (PZ3 50 mm), ● SL 4 50 mm, ● SL 5 50 mm, ● SL 6 50 mm, ● SL 8 50 mm, ⊙ T10 50 mm, ⊙ T15 50 mm, ⊙ T20 50 mm, ⊙ T50 50 mm, ⊙ T30 50 mm, ⊙ T40 50 mm

HT7G150	39,5 x 18 cm	1	5

x107 1/4" S2 CrV EVA

DE Werkzeugsatz EN Tool set FR Jeu d'outils ES Juego de herramientas HR Set alata HU Szerszámkészlet RO Set de scule BG Изолирани отвертки

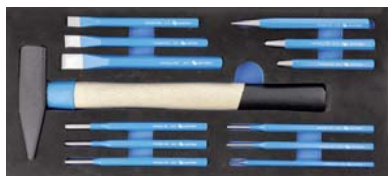

- HT3B005 (500 g), HT3B712 (Cold chisels: 10 x 140 mm, 12 x 150 mm, 16 x 170 mm, Taper punches: 1.5 x 150 mm, 3 x 150 mm, 4 x 150 mm, 5 x 150 mm, 6 x 150 mm, 8 x 150 mm, Centre punches: 2 x 140 mm, 6 x 100 mm, 8 x 115 mm)

HT7G151	39,5 x 18 cm	1	5

x13 CrV EVA



MARKETING SUPPORT

Wir bieten attraktive Aktionen, Treueprogramme, Schulungen. In jeder Phase der Zusammenarbeit stellen wir unseren Distributoren die erforderlichen Mittel zur Verfügung, um den Verkauf und die Präsentation des Produkts zu unterstützen:

- Regale;
- Displays;
- Drucksachen und Verkaufspunkt Materialien.

Wir arbeiten mit Vertriebspartnern auch individuell zusammen, je nach Potenzial und Bedarf des Kunden, und bieten Branding auf Baustellen, Aufzügen, Autos, Flaggen und Werbetafeln an. Wir sind immer offen für neue Ideen unserer Geschäftspartner. Unseren Distributoren steht außerdem eine umfangreiche Vertriebsabteilung zur Verfügung, die jederzeit für Unterstützung zur Verfügung steht.

Offene Ausstellungsregale

Maße: **100 x 250 x 55 cm** oder **60 x 250 x 55 cm**.

Für die Regale wurde zusätzliches Zubehör entworfen: Regalböden, Balken, Haken, Bügel und Schienen, die es ermöglichen, die Produkte zu kategorisieren und Waren verschiedener Größen zu präsentieren.



Geschlossene Ausstellungsregale

Maße: **100 x 250 x 55 cm** oder **60 x 250 x 55 cm**.

Regale mit diebstahlsicheren Türen.



Displays aus Pappe

Maße: **60 x 140 x 40 cm**.

Nutzlast: **80 kg**.

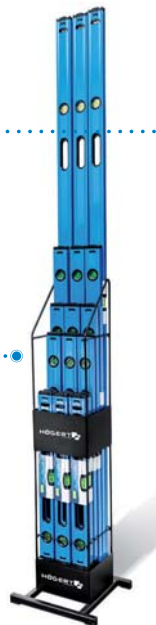

Displays für Bohrer und Bits

Maße: **33 x 29 x 111 cm**.

Metallkonstruktion.



Displays für Wasserwaagen

Maße: **32 x 60 x 100 cm**.

Metallkonstruktion mit Platz für 18 Wasserwaagen.



Produkt-Minidisplays – für den Kassentisch

Es besteht die Möglichkeit, Produkte auf dem Tisch oder direkt an der Kasse auszustellen.

MARKETING SUPPORT

We provide attractive promotions, loyalty programs and training. At each step of our cooperation, we provide necessary tools and product display stands to support sales:

- free-standing racks;
- displays and cardboard stands;
- printed materials and POS.

We also work with Distributors individually, according to the customer's potential and needs, offering branding on display windows, facades, cars, flags and billboards. We are always open to new ideas of our Business Partners. Additionally we have an extensive Sales Department at our Distributors' disposal, which always provides support.

Display and sales racks (open)

Dimensions: **100 x 250 x 55 cm** or **60 x 250 x 55 cm**.

Additional accessories have been designed for the racks: shelves, beams, hooks, hangers and strips, which allow you to categorize products and display goods of various sizes.



Display and sales racks (close)

Dimensions: **100 x 250 x 55 cm** or **60 x 250 x 55 cm**.

Racks with anti-theft doors.



Cardboard displays

Dimensions: **60 x 140 x 40 cm**.

Load capacity up to: **80 kg**.

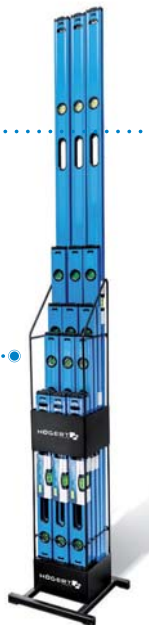

Displays for spirit levels

Dimensions: **33 x 29 x 111 cm**.

Metal construction with space for 18 spirit levels.



Drills and bits displays

Dimensions: **32 x 60 x 100 cm**.

Metal construction.



Mini product displays - counters

You can display products on the counter or directly near the cash register.

SOUTIEN MARKETING

Nous proposons des promotions avantageuses, des programmes de fidélisation, des formations. À chaque étape de la coopération, nous fournissons à nos distributeurs les outils nécessaires pour soutenir les ventes et la présentation des produits:

- Étagères;
- Présentoirs;
- matériel imprimé et PLV.

Nous coopérons également avec les distributeurs de manière personnalisée, en fonction du potentiel et de la demande du client, en proposant des marquages sur les vitrines, les façades, les voitures, les drapeaux, les panneaux publicitaires. Nous sommes toujours ouverts aux nouvelles idées venant de nos partenaires commerciaux. Nous disposons également d'un département de vente à la disposition de nos distributeurs, qui fournit toujours le soutien nécessaire.

Rayonnages de présentation-vente ouverts

Dimensions: **100 x 250 x 55 cm** ou **60 x 250 x 55 cm**.

Des accessoires supplémentaires ont été conçus pour les rayonnages: étagères, piliers, crochets, attaches et baguettes, lesquels permettent de classer et d'exposer des produits de différentes tailles.



Rayonnages de présentation-vente fermés

Dimensions: **100 x 250 x 55 cm** ou **60 x 250 x 55 cm**.

Rayonnages à portes sécurisées contre le vol.



Présentoirs en carton

Dimensions: **60 x 140 x 40 cm**.

Capacité de chargement: **80 kg**.

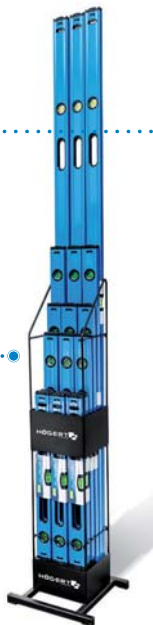

Présentoirs de forets et de mèches

Dimensions: **33 x 29 x 111 cm**.

Structure métallique.



Présentoirs à niveaux

Dimensions: **32 x 60 x 100 cm**.

Structure métallique pour 18 niveaux.



Mini-présentoirs de produits – comptoirs

Possibilité de présenter les produits sur le comptoir ou directement à la caisse.



APOYO AL MARKETING

Ofrecemos atractivas promociones, programas de fidelización y formación. En cada etapa de la colaboración proporcionamos a nuestros distribuidores las herramientas de apoyo a ventas así como la correcta exposición de los productos:

- Vitrinas;
- Expositores;
- material impreso y PLV.

Trabajamos también con los distribuidores de forma individual, según el potencial y las necesidades del cliente, ofreciendo el branding en escaparates, fachadas, coches, banderas, vallas publicitarias. Siempre estamos abiertos a nuevas ideas de nuestros socios comerciales. Al mismo tiempo ponemos a disposición de los distribuidores nuestro equipo de ventas para que los apoye.

Expositores de punto de venta abiertos

Dimensiones: **100 x 250 x 55 cm** o **60 x 250 x 55 cm**.

Se han diseñado accesorios adicionales para las estanterías: estantes, vigas, ganchos, colgadores y rieles que permiten clasificar los productos y exponer mercancías de distintos tamaños.



Expositores de punto de venta cerrados

Dimensiones: **100 x 250 x 55 cm** o **60 x 250 x 55 cm**.

Expositores con puertas antirrobo.



Expositores de cartón

Dimensiones: **60 x 140 x 40 cm**.

Carga útil: **80 kg**.

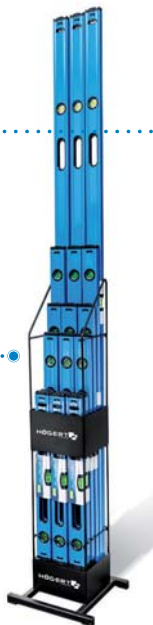

Expositores de brocas y puntas

Dimensiones: **33 x 29 x 111 cm**.

Construcción de metal.



Expositores de nivel

Dimensiones: **32 x 60 x 100 cm**.

Construcción de metal con espacio para 18 niveles de burbuja.



Miniexpositores de productos – mostrador

Posibilidad de exponer los productos en el mostrador o directamente en la caja registradora.



MARKETINŠKA PODRŠKA

pripremamo atraktivne promocije, programe odanosti, edukacije. U svakoj fazi suradnje našim distributerima pružamo potrebne alate za potporu prodaji i izložbu proizvoda:

- police;
- displeji;
- tiskani materijali i POS.

Našim distributerima također pristupamo individualnu, u skladu s njihovim potencijalom i potrebama, nudeći pomoć u pripremi izloga, brendiranje na zgradama, automobilima, zastavama i reklamnim panoima. Uvijek smo otvoreni za nove ideje naših poslovnih partnera. Našim distributerima također na raspolaganju stoji opsežni Odjel Prodaje.

Regali za izlaganje i prodaju otvorenog tipa

Dimenzije: **100 x 250 x 55 cm** ili **60 x 250 x 55 cm**.

Za regale je predviđeni dodatni pribor: police, grede, kuke, vješalice i trake, koji omogućuju kategoriziranje proizvoda i izlaganje robe različitih veličina.



Regali za izlaganje i prodaju zatvorenog tipa

Dimenzije: **100 x 250 x 55 cm** ili **60 x 250 x 55 cm**.

Regali s vratima protiv krađe.

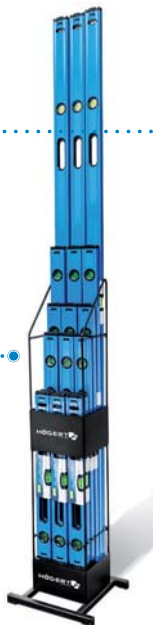

Kartonske izložbene police

Dimenzije: **60 x 140 x 40 cm**.

Nosivost **80 kg**.



Izložbene police za svrdla i bitove

Dimenzije: **32 x 60 x 100 cm**.

Metalna konstrukcija.



Izložbene police za libele

Dimenzije: **33 x 29 x 111 cm**.

Metalna konstrukcija s prostorom za 18 libela.



Mini izložbene police – za pult

Mogućnost izlaganja proizvoda na pultu ili izravno pored blagajne.

MARKETINGTÁMOGATÁS

Vonzó kedvezményeket, hűségprogramokat és oktatásokat biztosítunk. Az együttműködés minden szakaszában forgalmazóink rendelkezésére bocsátjuk a termékek értékesítéséhez és megjelenítéséhez szükséges eszközöket:

- polcos állványokat,
- kiállítási eszközöket,
- nyomtatott anyagokat és POS anyagot.

A forgalmazókkal egyénileg is együttműködünk, az ügyfelek potenciáljának és igényeinek megfelelően, márkamegjelenítést kínálva a kirakatokban, a homlokzatokon, autókon, zászlókon, hirdetőtáblákon.

Mindig nyitottak vagyunk Üzleti Partnereink új ötleteire. Forgalmazóink rendelkezésére bocsátunk egy kiterjedt Értékesítési Osztályt is, amely mindig támogatást nyújt szükség esetén.

Nyitott értékesítési állványok

Méretek: **100 x 250 x 55 cm** vagy **60 x 250 x 55 cm**.

Az állványokhoz további tartozékok rendelhetők: polcok, gerendák, kampók, akasztók és sínek, amelyek lehetővé teszik a termékek kategorizálását és különböző méretű áruk megjelenítését.



Zárt értékesítési állványok

Méretek: **100 x 250 x 55 cm** vagy **60 x 250 x 55 cm**.

Lopásgátló ajtókkal ellátott polcok.

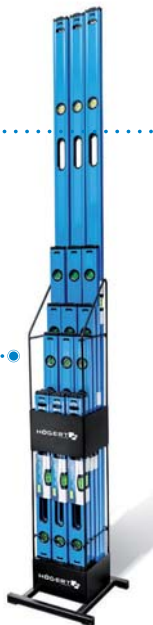

Karton állványok

Méretek: **60 x 140 x 40 cm**.

Terhelhetőség: **80 kg**.



Fúrószár és bit állványok

Méretek: **32 x 60 x 100 cm**.

Fém szerkezet.



Vízmérték állványok

Méretek: **33 x 29 x 111 cm**.

Fém szerkezet, 18 vízmérték helyel



Pultra helyezhető mini termékkínálók

Lehetőséget nyújt a termékek pultron vagy közvetlenül a pénztárgépnél történő megjelenítésére.

SUPPORT DE MARKETING

Oferim promoții atractive, programe de loialitate, cursuri de formare. În fiecare etapă de cooperare, oferim Distribuitorilor noștri instrumentele necesare pentru a susține vânzarea și expunerea produsului:

- rafturi,
- echipamente pentru expunere,
- materiale tipărite și materiale POS.

Lucrăm cu Distribuitorii și în mod individual, în funcție de potențialul și cererea Clientului, oferind branding pe vitrine, fațade, mașini, steaguri, panouri publicitare. Suntem întotdeauna deschiși noilor idei ale Partenerilor noștri de afaceri. Avem la dispoziția Distribuitorilor noștri, și un Departament de Vânzări extins, care este întotdeauna disponibil pentru suport.

Rafturi deschise pentru expunere a produselor

Dimensiuni: **100 x 250 x 55 cm** sau **60 x 250 x 55 cm**.

Pentru rafturi au fost concepute accesoriile suplimentare: polițe, grinzi, cârlige, umerase și șine care permit clasificarea produselor și expunerea mărfurilor de diferite dimensiuni.



Rafturi închise pentru expunere a produselor

Dimensiuni: **100 x 250 x 55 cm** sau **60 x 250 x 55 cm**.

Rafturi cu uși antifurt.



Expozitoare din carton

Dimensiuni: **60 x 140 x 40 cm**.

Capacitate de încărcare: **80 kg**.

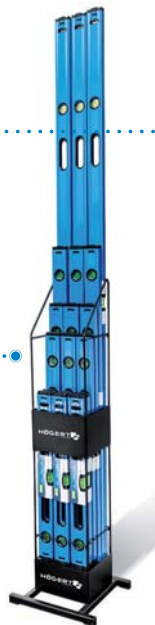

Expozitoare pentru burghie și biți

Dimensiuni: **32 x 60 x 100 cm**.

Structură metalică.



Expozitoare pentru dreptare

Dimensiuni: **33 x 29 x 111 cm**.

Construcție metalică cu spațiu pentru 18 nivele cu bulă de aer.



Mini-expozitoare de produse – pe tejghea

Posibilitatea de a expune produsele pe tejghea sau direct la casa de marcat.



МАРКЕТИНГОВА ПОДКРЕПА

Предлагаме атрактивни промоции, програми за лоялност и обучения. На всеки етап от сътрудничеството предоставяме необходимите инструменти в подкрепа на продажбите и излагането на продукти:

- свободно стоящи стелажи;
- дисплеи и картонени стойки;
- печатни материали и ПОС.

Ние също работим с индивидуално дистрибутори, според потенциала и нуждите на клиента, предлагайки брандиране на витрини, фасади, автомобили, знамена и билбордове. Винаги сме отворени на нови идеи на нашите бизнес партньори. На разположение на нашите дистрибутори имаме голем отедл Продажба, който винаги осигурява подкрепа.

Стелажи и дисплеи отворени

Размери: **100 x 250 x 55 cm** или **60 x 250 x 55 cm**.

За стелажите са проектирани допълнителни аксесоари: рафтове, греди, куки, закачалки и ленти, които ви позволяват да категоризирате продуктите и да показвате стока с различни размери.



Стелажи и дисплеи затворени

Размери: **100 x 250 x 55 cm** или **60 x 250 x 55 cm**.

Стелажи с врати против кражба.



Картонени дисплеи

Размери: **60 x 140 x 40 cm**.

Товароносимост: **80 кг**.

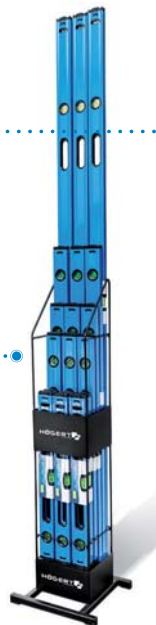

Дисплеи за свредла и битове

Размери: **32 x 60 x 100 cm**.

Метална конструкция.



Дисплеи за нивелири

Размери: **33 x 29 x 111 cm**.

Метална конструкция с място за 18 нивелири.



Мини продуктови дисплеи – гишета

Възможност за излагане на продукти на гише или директно в касата.





DE Kunststoff EN Plastic **FR** Plastique **ES** Plástico **HR** Sintetika **HU** Műanyag **RO** Plastic **BG** Материал



DE Aluminium EN Aluminum **FR** Aluminium **ES** Aluminio **HR** Aluminij **HU** Alumínium **RO** Aluminiu **BG** Алюминий



DE Aluminium-Griff EN Aluminum handle **FR** Poignée en aluminium **ES** Asa de aluminio **HR** Aluminijaska ručka **HU** Alumínium fogantyú **RO** Suport din aluminiu **BG** Алюминиева дръжка



DE ABS-Griff EN ABS handle **FR** Poignée en ABS **ES** Asa de ABS **HR** Ručka od ABS **HU** ABS fogantyú **RO** Măner ABS **BG** Дръжка от ABS



DE Aluminium-Gehäuse EN Aluminum housing **FR** Boîtier en aluminium **ES** Carcasa de aluminio **HR** Aluminijsko kućište **HU** Alumínium burkolat **RO** Carcasă din aluminiu **BG** Алюминиев корпус



DE Nietmaschinengehäuse aus Aluminium EN Aluminum riveter housing **FR** Boîtier en aluminium de riveteuse **ES** Carcasa de aluminio para remachadora **HR** Aluminijsko kućište kliješta za zakivanje **HU** Alumínium szegeszélszerszám burkolat **RO** Carcasă din aluminiu pentru unealta de nituit **BG** Алюминиев корпус за нитове



DE Heftergehäuse aus Aluminium EN Aluminum riveter housing **FR** Boîtier en aluminium d'agrafeuse **ES** Carcasa de grapadora de aluminio **HR** Aluminijsko kućište klemarice **HU** Alumínium tűzőgép burkolat **RO** Carcasă pentru capsator **BG** Алюминиев корпус за телбод



DE Aluminium-Messergriff EN Aluminum knife's handle **FR** Manche de couteau en aluminium **ES** Mango del cuchillo de aluminio **HR** Aluminijaska ručka noža **HU** Alumínium kés nyél **RO** Măner de cuțit din aluminiu **BG** Алюминиева дръжка за нож



DE Aluminium-Schaumpistolengehäuse EN Foam gun body -Aluminum **FR** Corps du pistolet à mousse en aluminium **ES** Cuerpo de la pistola de espuma de aluminio **HR** Aluminijsko tijelo pištolja za pjenu **HU** Alumínium habszórópisztoly ház **RO** Corpul pistolului pentru spumă din aluminiu **BG** Алюминиев корпус на pistolет за пяна



DE Sägerahmen aus Aluminium EN Aluminum saw frame **FR** Cadre de scie en aluminium **ES** Marco de sierra de aluminio **HR** Aluminijski okvir pile **HU** Alumínium fűrész keret **RO** Cadru de ferăstrău din aluminiu **BG** Алюминиева рамка за трион



DE Aluminium-Griff EN Aluminum handle **FR** Manche en aluminium **ES** Asa de aluminio **HR** Aluminijaska ručka **HU** Alumínium fogantyú **RO** Măner din aluminiu **BG** Алюминиева дръжка



DE Aluminium-Kistenverschluss EN Aluminum box latch **FR** Loquet de boîte en aluminium **ES** Cierre de caja de aluminio **HR** Aluminijaska zaklopka kutije **HU** Alumínium doboz retesz **RO** Încuietoare din aluminiu pentru cutie **BG** Алюминиев резе за кутия



DE Aluminium-Verschlüsse EN Aluminum clasps **FR** Fermoirs en aluminium **ES** Cierres de aluminio **HR** Aluminijске корпе **HU** Alumínium kapcsok **RO** Încizători din aluminiu **BG** Алюминиеви закопчалки



DE Aluminium- und Kupferkabel EN Aluminum and copper cables **FR** Câbles en aluminium et en cuivre **ES** Cables de aluminio y cobre **HR** Aluminijski i bakreni kablovi **HU** Alumínium és réz kábelek **RO** Cabluri din aluminiu și cupru **BG** Алюминиеви и медни кабели



DE Aluminium- und Kupferrohre EN Aluminum and copper pipes **FR** Tubes en aluminium et en cuivre **ES** Tubos de aluminio y cobre **HR** Aluminijске i bakrene cijevi **HU** Alumínium és réz csövek **RO** Ţevi din aluminiu și cupru **BG** Алюминиеви и медни тръби



DE Einnietmutter aus Aluminium EN Aluminum rivet nuts **FR** Écrous à rivets en aluminium **ES** Tuercas remachables de aluminio **HR** Aluminijске zakrivne matice **HU** Alumínium szegeszanyák **RO** Piulițe nituite din aluminiu **BG** Алюминиеви гайки



DE Gehäuse aus Aluminium-Verbundwerkstoff EN Aluminum rivet nuts **FR** Boîtier en composite et aluminium **ES** Carcasa de aluminio compuesto **HR** Aluminijsko-kompozitno kućište **HU** Alumínium-kompozit borítás **RO** Carcasă din aluminiu-compozit **BG** Алюминиево-копозитен



DE Aluminiumguss EN Die-cast aluminum **FR** Fonte d'aluminium **ES** Fundición a presión de aluminio **HR** Aluminijski odljevak **HU** Alumínium öntvény **RO** Aluminiu turnat **BG** Алюминиева форма



DE Werkstoff Al Cu EN Al Cu material **FR** Matériau Al Cu **ES** Material Al Cu **HR** Materijal Al Cu **HU** Al Cu anyag **RO** Material Al Cu **BG** Материал Al Cu



DE Zwei Metalle oder Metalllegierungen kombiniert EN Combined two metals or metal alloys **FR** Deux métaux ou alliages de métaux combinés **ES** Dos metales o aleaciones metálicas combinadas **HR** Kombinacija dva metala ili dviju metalnih legura **HU** Két fém vagy fémötvözet kombinációja **RO** Două metale sau aliaje metalice combinate **BG** Съюзани два метала или метални сплави



DE Bi-Metall-Klinge EN Bi-metal saw blade **FR** Lame bi-métal **ES** Hoja de sierra bimetálica **HR** Bimetal list za pile **HU** Bi-fém lap **RO** Pânză bimetalică **BG** Биметален трион



DE Bi-Metall-Klingen M2 EN M2 bi-metal blades **FR** Lames bi-métal M2 **ES** Cuchillas bimetálicas M2 **HR** Bimetal M2 oštrice **HU** M2 bimetál pengék **RO** Lame bimetalice M2 **BG** Биметален ръб M2



DE Bi-Metall-Klingen M42 EN M42 bi-metal blades **FR** Lames bi-métal M42 **ES** Cuchillas bimetálicas M42 **HR** Bimetal M42 oštrice **HU** M42 bimetál pengék **RO** Lame bimetalice M42 **BG** Биметален ръб M42



DE Messing EN Brass **FR** Laiton **ES** Latón **HR** Mesing **HU** Sárgaréz **RO** Alamă **BG** Месинг



DE Hartmetall EN Carbide **FR** Carbone **ES** Carburo **HR** Karbid **HU** Karbid **RO** Carbură **BG** Карбид



DE Gusseisen EN Cast iron **FR** Fonte **ES** Hierro fundido **HR** Lijevano željezo **HU** Öntöttvas **RO** Fontă **BG** Материал желязо



DE Material Gusseisen EN Cast iron material **FR** Matériau : fonte **ES** Material Hierro fundido **HR** Materijal lijevano željezo **HU** Öntöttvas anyag **RO** Material fontă **BG** Чугунен материал



DE Kupfer EN Copper **FR** Cuivre **ES** Cobre **HR** Bakar **HU** Réz **RO** Cupru **BG** Мед



DE Kupfer, Nickel, Zink EN Copper, nickel, zinc **FR** Cuivre, nickel, zinc **ES** Cobre, níquel, zinc **HR** Bakar, nikel, cink **HU** Réz, nikkel, cink **RO** Cupru, nichel, zinc **BG** Мед, никел, цинк



DE Keramik EN Ceramics **FR** Céramique **ES** Cerámica **HR** Keramika **HU** Kerámia **RO** Ceramică **BG** Керамика



DE Kobalt EN Cobalt **FR** Cobalt **ES** Cobalto **HR** Kobalt **HU** Kobalt **RO** Cobalt **BG** Кобалт



DE 5% Kobalt EN 5% cobalt **FR** 5% de cobalt **ES** 5% de cobalto **HR** 5% kobalta **HU** 5% kobalt **RO** 5% cobalt **BG** 5% кобалт



DE 8% Kobalt EN 8% cobalt **FR** 8% de cobalt **ES** 8% de cobalto **HR** 8% kobalta **HU** 8% kobalt **RO** 8% cobalt **BG** 8% кобалт



DE Beton EN Concrete **FR** Béton **ES** Hormigón **HR** Beton **HU** Beton **RO** Beton **BG** Бетон



DE Stahl EN steel **FR** Acier **ES** Acero **HR** Čelik **HU** Acél **RO** Oțel **BG** Стомана



DE Stahl-Schlagbolzen EN Steel spike **FR** Percuteur en acier **ES** Aguja de acero **HR** Čelična iglica **HU** Acél tű **RO** Percutor din oțel **BG** Стоманен шпил



DE Stahldüse EN nozzle **FR** Buse en acier **ES** Boquilla de acero **HR** Čelična mlaznica **HU** Acél fúvóka **RO** Duză din oțel **BG** Стоманена дюза



DE Metallscharniere EN Metal hinges **FR** Charnières en métal **ES** Bisagras metálicas **HR** Metalne šarke **HU** Fém zsanérok **RO** Balamale metalice **BG** Метални панти



DE Stahlband EN Steel tape **FR** Ruban en acier **ES** Correa de acero **HR** Čelična traka **HU** Acél szalag **RO** Bandă din oțel **BG** Стоманена лента



DE Stahlband EN Steel tape **FR** Ruban en acier **ES** Correa de acero **HR** Čelična traka **HU** Acél szalag **RO** Bandă din oțel **BG** Стоманена лента



DE Stahl und Inox EN Steel and inox **FR** Acier et inox **ES** Acero e inox **HR** Čelik i inox **HU** Acél és inox **RO** Oțel și inox **BG** Стомана и инокс



DE Art von Stahl EN Type of steel **FR** Type d'acier **ES** Tipo de acero **HR** Vrsta čelika **HU** Acél típus **RO** Tipul de oțel **BG** Вид стомана



DE Material Stahl EN Material steel **FR** Matériau: acier **ES** Material acero **HR** Materijal čelik **HU** Acél anyag **RO** Material oțel **BG** Материал стомана



DE INOX-Material EN INOX material **FR** Matériau INOX **ES** Material INOX **HR** Materijal INOX **HU** INOX anyag **RO** Material INOX **BG** INOX материал



DE Material Stahl, PVC EN Material steel, PVC **FR** Matériau : acier, PVC **ES** Material acero, PVC **HR** Materijal čelik, PVC **HU** Acél, PVC anyag **RO** Material oțel, PVC **BG** Материал стомана, PVC



DE Klinge aus SK5-Stahl EN SK5 steel blade **FR** Lame en acier SK5 **ES** Hoja de acero SK5 **HR** Oštrica od SK5 čelika **HU** SK5 acél penge **RO** Lamă fabricată din oțel SK5 **BG** Стоманено острие SK5



DE Schneidmesser aus SK5-Stahl EN Cutting blade made of SK5 steel **FR** Lame de coupe en acier SK5 **ES** Cuchilla de corte de acero SK5 **HR** Rezna oštrica od SK5 čelika **HU** SK5 acél vágó penge **RO** Lamă de tăiere din oțel SK5 **BG** Режешо острие от стомана SK5



DE Klinge aus Cr12MoV-Stahl **EN** Cr12MoV steel blade **FR** Lame en acier Cr12MoV **ES** Hoja de acero Cr12MoV **HR** Oštrica od Cr-12MoV čelika **HU** Cr12MoV acél penge **RO** Lamă fabricată din oțel Cr12MoV **BG** Стоманено острие Cr12MoV



DE Chrom-Molybdän-legierter Stahl **EN** Chrome molybdenum alloy steel **FR** Acier allié au chrome-molybdène **ES** Acero de aleación de cromo-molibdèno **HR** Čelik od legure krom molibdena **HU** Króm-molibdén ötvözött acél **RO** Oțel din aliaj de crom-molibden **BG** Хромирана молибденова легирана стомана



DE Ratschenmechanismus aus Chrom-Molybdän-Legierung **EN** Chrome-molybdenum alloy ratchet mechanism **FR** Mécanisme du cliquet en alliage chrome-molybdène **ES** Mecanismo de trinquete de acero de aleación de cromo-molibdèno **HR** Mehaniizam čegrtaljke od legiranog čelika od krom molibdena **HU** Króm-molibdén ötvözött acél készült racsnis mechanizmus **RO** Mecanism cu clichet din aliaj de crom-molibden **BG** Хралови механизъм от хром-молибденова сплав



DE Dreifach-Backen aus Chrom-Molybdän-Legierung **EN** Triple jaws made of chrome-molybdenum alloy steel **FR** Mâchoires triples en acier allié chrome-molybdène **ES** Mordazas de acero de triple aleación de cromo-molibdèno **HR** 3 čeljusti od legiranog čelika od krom molibdena **HU** Króm-molibdén ötvözött acélból készült tripla pofa **RO** Fălci triple din aliaj de oțel cu crom-molibden **BG** тройни стяги, изработени от легирана стомана от хром-молибден



DE Chrom-Nickel-Stahl **EN** Chrome-nickel alloy steel **FR** Acier allié au chrome-nickel **ES** Acero de aleación de cromo-níquel **HR** Legirani čelik krom-nikal **HU** Króm-nikkel ötvözött acél **RO** Oțel aliat crom-nichel **BG** Легирана стомана от хром-никел



DE Chrom-Vanadium-Stahl **EN** Chrome vanadium alloy steel **FR** Acier allié au chrome-vanadium **ES** Acero de aleación de cromo-vanadio **HR** Krom-vanadijev legirani čelik **HU** Króm-vanádium ötvözött acél **RO** Oțel aliat cu crom-vanadiu **BG** Хром -ванадиева легирана стомана



DE Klinge aus Kohlenstoffstahl C45 **EN** C45 carbon steel head **FR** Tête en acier au carbone C45 **ES** Hoja de acero al carbono C45 **HR** Glava od ugljičnog čelika C45 **HU** Szénacéltól készült C45 penge **RO** Cap din oțel carbon C45 **BG** Форма от въглеродна стомана C45



DE Glas **EN** Glass **FR** Verre **ES** Vidrio **HR** Staklo **HU** Üveg **RO** Sticlă **BG** Стькло



DE Legierter Hochgeschwindigkeitsstahl **EN** High speed cut alloy steel **FR** Acier allié à haute vitesse **ES** Acero aleado de alta velocidad **HR** Brzorezni legirani čelik **HU** Gyorsvágó ötvözött acél **RO** Oțel aliat pentru tăiere de mare viteză **BG** Легирана стомана с висока скорост



DE Inox **EN** Inox **FR** Inox **ES** Inox **HR** Inox **HU** Inox **RO** Inox **BG** Inox



DE Leder **EN** Leather **FR** Cuir **ES** Cuero **HR** Koža **HU** Bőr **RO** Piele **BG** Кожа



DE Nagel **EN** Nail **FR** Clou **ES** Clavo **HR** Čavao **HU** Szög **RO** Cui **BG** Пирон



DE Nylon **EN** Nylon **FR** Nylon **ES** Nylon **HR** Najlon **HU** Nejlon **RO** Nailon **BG** Найлон



DE Nylonbeschichtetes Band **EN** Tape coated with nylon **FR** Ruban recouvert de nylon **ES** Correa recubierta de nylon **HR** Traka prekrivena najlonom **HU** Nylon bevonatú szalag **RO** Bandă acoperită cu nailon **BG** Лента с винилово покритие



DE Vinylbeschichtetes Band **EN** Tape coated with vinyl **FR** Ruban recouvert de vinyle **ES** Cinta con revestimiento de vinilo **HR** Traka prekrivena vinilom **HU** Vinil bevonatú szalag **RO** Bandă acoperită cu vinil **BG** Лента с винилово покритие



DE Stahlband **EN** Steel tape **FR** Ruban en acier **ES** Correa de acero **HR** Čelična traka **HU** Acél szalag **RO** Bandă din oțel **BG** Стоманена лента



DE Aluminiumlegierung **EN** Aluminum alloy **FR** Alliage d'aluminium **ES** Aleación de aluminio **HR** Alumijska legura **HU** Alumínium ötvözet **RO** Aliaj de aluminiu **BG** Алуминиева сплав



DE Polyethylen **EN** Polyethylene **FR** Polyéthylène **ES** Polietileno **HR** Polietilen **HU** Polietilén **RO** Polietilenă **BG** Полиетилен



DE Backen aus Polyethylen **EN** Polyethylene jaws **FR** Mâchoires en polyéthylène **ES** Mordazas de polietileno **HR** Polietilenske čeljusti **HU** Polietilén pofák **RO** Fălci din polietilenă **BG** Полиетиленови стяги



DE Rohre aus Polyethylen und Aluminium **EN** Polyethylene and aluminum pipes **FR** Tubes en polyéthylène et en aluminium **ES** Tubos de polietileno y aluminio **HR** Polietilenske i aluminijске cijevi **HU** Polietilén és alumínium csövek **RO** Ţevi din polietilenă și aluminiu **BG** Полиетиленови и алуминиеви тръби



DE Polyethylen-Kombination **EN** Polyethylene combination **FR** Combinaison de polyéthylène **ES** Combinación de polietileno **HR** Polietilenska kombinacija **HU** Polietilén kombináció **RO** Combinație de polietilenă **BG** Комбинация от полиетилен



DE Polyethylen-Aluminium-Kombination **EN** Polyethylene combination with aluminum **FR** Combinaison polyéthylène-aluminium **ES** Combinación de polietileno y aluminio **HR** Kombinacija polietilena i aluminja **HU** Polietilén és alumínium kombináció **RO** Combinație de polietilenă cu aluminiu **BG** Комбинация от полиетилен и алуминий



DE PTFE-beschichtete Schutzschicht **EN** PTFE coated shell **FR** Revêtement enduit de PTFE **ES** Revestimiento de PTFE **HR** Površina premazana PTFE-om **HU** PTFE bevonattal ellátott bevonat **RO** Acoperire cu strat de PTFE **BG** Копрус с PTFE покритие



DE Kunststoff **EN** Plastic **FR** Plastique **ES** Plástico **HR** Plastika **HU** Műanyag **RO** Plastic **BG** Пластмаса



DE Polypropylen **EN** Polypropylene **FR** Polypropylène **ES** Polipropileno **HR** Polipropilen **HU** Polipropilén **RO** Polipropilenă **BG** Полипропилен



DE Polypropylen-Kombination **EN** Polypropylene combination **FR** Combinaison de polypropylène **ES** Combinación de polipropileno **HR** Polipropilenska kombinacija **HU** Polipropilén kombináció **RO** Combinație de polipropilenă **BG** Комбинация от полипропилен



DE Polyurethan **EN** Polyurethane **FR** Polyuréthane **ES** Poliuretano **HR** Poliuretán **HU** Poliuretán **RO** Poliuretán **BG** Полиуретан



DE Polyvinylchlorid **EN** Polyvinyl chloride **FR** Chlorure de polyvinyle **ES** Cloruro de polivinilo **HR** PVC **HU** Polivinil-klorid **RO** Policlorură de vinil **BG** Поливинил хлорид



DE Technischer EVA-Schaum **EN** Technical foam EVA **FR** Mousse technique EVA **ES** Espuma técnica EVA **HR** Tehnička pjena EVA **HU** EVA műszaki hab **RO** Spumă tehnică EVA **BG** Техническа вложка EVA



DE Polychlorierte und Polypropylen-Röhrchen **EN** Polychloride and polypropylene pipes **FR** Tubes en polychlorure et polypropylène **ES** Tubos policlorados y de polipropileno **HR** Polivinilkloridne i polipropilenske cijevi **HU** Polivinil-klorid és polipropilén csövek **RO** Ţevi policlorurate și din polipropilenă **BG** Полихлоридни и полипропиленови тръби



DE Cu_Al-Rohre **EN** Cu_Al pipes **FR** Tubes Cu_Al **ES** Tubos de Cu_Al **HR** Cu_Al cijevi **HU** Cu_Al csövek **RO** Ţevi Cu_Al **BG** Cu_Al тръби



DE PP-Rohre **EN** PP pipes **FR** Tubes en PP **ES** Tubos PP **HR** PP cijevi **HU** PP csövek **RO** Ţevi PP **BG** PP тръби



DE PVC-Rohre **EN** PVC pipes **FR** Tubes en PVC **ES** Tubos de PVC **HR** PVC cijevi **HU** PVC csövek **RO** Ţevi PVC **BG** PVC тръби



DE Rostfreier Stahl **EN** stainless steel **FR** Acier inoxydable **ES** Acero inoxidable **HR** Nehradajući čelik **HU** Rozsdamentes acél **RO** Oțel inoxidabil **BG** Нерждаема стомана



DE Material rostfreier Stahl **EN** Material stainless steel **FR** Matériau : acier inoxydable **ES** Material acero inoxidable **HR** Materijal nehrđajući čelik **HU** Rozsdamentes acél anyag **RO** Material oțel inoxidabil **BG** Материал нерждаема стомана



DE ABS-Material **EN** ABS material **FR** Matériau ABS **ES** Material ABS **HR** Materijal ABS **HU** ABS anyag **RO** Material ABS **BG** ABS материал



DE EPDM-Material **EN** EPDM material **FR** Matériau EPDM **ES** Material EPDM **HR** Materijal EPDM **HU** EPDM anyag **RO** Material EPDM **BG** EPDM материал



DE S2-Material **EN** S2 material **FR** Matériau S2 **ES** Material S2 **HR** Materijal S2 **HU** S2 anyag **RO** Material S2 **BG** Материал S2



DE Stahlprofil **EN** Steel profile **FR** Profilé en acier **ES** Perfil de acero **HR** Čelični profil **HU** Acél profil **RO** Profil de oțel **BG** Стоманен профил



DE Stahlschiene **EN** Steel rail **FR** Rail en acier **ES** Carril de acero **HR** Čelična šina **HU** Acél sín **RO** Șină de oțel **BG** Стоманена пенса



DE Schneidmesser aus Edelstahl **EN** Cutting blade made of stainless steel **FR** Lame de coupe en acier inoxydable **ES** Hoja de corte de acero inoxidable **HR** Rezne oštrice od nehrđajućeg čelika **HU** Rozsdamentes acél vágópengé **RO** Lamă de tăiere din oțel inoxidabil **BG** Режешо острие от нерждаема стомана



DE Einnietmuttern aus Stahl und Edelstahl **EN** Steel and stainless steel rivet nuts **FR** Écrous à rivets en acier et en acier inoxydable **ES** Tuercas remachables de acero y acero inoxidable **HR** Zakivne matice od nehrđajućeg čelika **HU** Acél és rozsdamentes acél szegescsanyák **RO** Pulițe niuite din oțel și oțel inoxidabil **BG** Стоманени и нерждаеми гайки с нитове



DE Metall **EN** Metal **FR** Métal **ES** Metal **HR** Metal **HU** Fém **RO** Metal **BG** Метал



DE Metallverschluss **EN** Metal closure **FR** Fermeture en métal **ES** Cierre metálico **HR** Metalna zaklopka **HU** Fém zár **RO** Inchidere metalică **BG** Метално затваряне



DE Hartmetallklingen **EN** Carbide blades **FR** Lames en carbure cémenté **ES** Cuchillas de carburo **HR** Oštrice od sinteriranog karbida **HU** Szinterezett karbid pengék **RO** Lame de carbură **BG** Карбидни остриета



DE Teflon-Beschichtung EN Teflon shell **FR** Revêtement en téflon **ES** Revestimiento de teflón **HR** Teflonska prevlaka **HU** Teflon bevonat **RO** Înzeliți de teflon **BG** Тефлоново покритие



DE Sperrholz EN Plywood **FR** Contreplaqué **ES** Madera contrachapada **HR** Šperploča **HU** Rétegelt lemez **RO** Placă **BG** Шпеплнат



DE Zertifikat für sicheres Arbeiten unter Spannung EN Safety certificate for working under voltage **FR** Certificat de sécurité pour le travail sous tension **ES** Certificado de seguridad para trabajar bajo tensión **HR** Sigurnosni certifikat za rad pod naponom **HU** Feszültség alatt történő munkavégzési biztonsági bizonyítvány **RO** Certificat pentru lucrul în condiții de siguranță în timpul lucrului sub tensiune **BG** Сертификат за безопасност при работа под напрежение



DE Keramik-Fliesen EN Ceramic tiles **FR** Plaques en céramique **ES** Baldosas de cerámica **HR** Keramičke pločice **HU** Kerámia lapok **RO** Plăci ceramice **BG** Керамични плочки



DE Holz mit Nägeln EN Wood with nails **FR** Bois avec clous **ES** Madera con clavos **HR** Drvo s čavlima **HU** Szögelt fa **RO** Lemn cu cuie **BG** Дърво с пирони



DE Das Produkt entspricht der jeweiligen Norm der Zertifizierungsstelle des DIN Deutsches Institut für Normung EN The product meets the relevant standard of the DIN Deutsches Institut für Normung certification body **FR** Le produit est conforme à la norme correspondante de l'organisme de certification DIN Deutsches Institut für Normung **ES** El producto cumple la norma correspondiente del organismo de certificación DIN Deutsches Institut für Normung **HR** Proizvod ispunjava zadane standarde certifikacijskog tijela DIN Deutsches Institut für Normung **HU** A termék megfelel a DIN Deutsches Institut für Normung tanúsító szervezet vonatkozó szabványának **RO** Produsul îndeplinește standardul respectiv al organismului de certificare DIN Deutsches Institut für Normung **BG** Продуктът отговаря на съответния стандарт на сертифициращия орган на DIN Deutsches Institut für Normung



DE Titan-Beschichtung EN Titanium shell **FR** Revêtement en titane **ES** Revestimiento de titanio **HR** Titanijum prevlaka **HU** Titán bevonat **RO** Înzeliți de titan **BG** Титаново покритие



DE MDF-Platte EN MDF **FR** Panneau MDF **ES** MDF **HR** MDF ploča **HU** MDF lap **RO** Placă MDF **BG** MDF



DE Thermoplastischer Kautschuk EN Thermoplastic rubber **FR** Caoutchouc thermoplastique **ES** Caucho termoplástico **HR** Termoplastični kaučuk **HU** Hőre lágyuló kaucsuk **RO** Cauciuc termoplastic **BG** Термопластична гума



DE Spanplatte EN Particle board **FR** Panneau d'aggloméré **ES** Tablero de partículas **HR** Iverica **HU** Forgácstemez **RO** Placă PAL **BG** ПДЧ песачик



DE Thermoplastische Elastomere EN Thermoplastic elastomers **FR** Élastomères thermoplastiques **ES** Elastómeros termoplásticos **HR** Termoplastični elastomeri **HU** Hőre lágyuló elastomerek **RO** Elastomeri termoplastici **BG** Термопластични еластомери



DE Tischplatte EN Worktops **FR** Plateau de table **ES** Tablero de la mesa **HR** Radna ploča **HU** Asztallap **RO** Blat de masă **BG** Работен плот



DE Schaft nach DIN 1041 gefertigt EN Head is made in accordance with 7239 DIN **FR** Tête conforme à la norme 1041 DIN **ES** Mango fabricado según la norma 1041 DIN **HR** Glava je izrađena u skladu sa standardom 1041 DIN **HU** A fej a DIN 1041 norma szerint készült **RO** Cap realizat în conformitate cu standardul 1041 DIN **BG** Опрма е изработена в съответствие с DIN 1041



DE Holz, Kunststoff, Aluminium EN Wood, plastic, aluminium **FR** Bois, plastique, aluminium **ES** Madera, plástico, aluminio **HR** Drvo, plastika, aluminij **HU** Fa, műanyag, alumínium **RO** Lemn, plastic, aluminiu **BG** Дърво, пластмаса, алуминий



DE Holzschneiden EN Wood cutting **FR** Coupe du bois **ES** Corte de madera **HR** Rezanje drva **HU** Fa vágás **RO** Taierea lemnului **BG** Рязане на дърво



DE Das Produkt entspricht der einschlägigen europäischen Norm EN The product meets the European standard **FR** Le produit est conforme à la norme européenne correspondante **ES** Producto cumple con la norma europea correspondiente **HR** Proizvod zadovoljava zadani europski standard **HU** A termék megfelel a vonatkozó európai szabványának **RO** Produsul este conform cu standardul european relevant **BG** Продуктът отговаря на дадения европейски стандарт



DE Wolframcarbide EN Tungsten carbide **FR** Carbure de tungstène **ES** Carburo de tungsteno **HR** Volframov karbid **HU** Volfrám-karbid **RO** Carbură de tungsten **BG** Волфрамов карбид



DE Metallschneiden EN Metal cutting **FR** Coupe du métal **ES** Corte de metales **HR** Rezanje metala **HU** Fém vágás **RO** Taierea metalelor **BG** Рязане на метал



DE Zink EN Zinc **FR** Zinc **ES** Zinc **HR** Cink **HU** Cink **RO** Zinc **BG** Цинк



DE Schneiden von Holz und Metall EN Wood and metal cutting **FR** Coupe du bois et du métal **ES** Corte de madera y metal **HR** Rezanje drva i metala **HU** Fa, és fém vágás **RO** Taierea lemnului și a metalului **BG** Рязане на дърво и метал



DE Qualitätszeichen vom TÜV Rheinland verliehen EN Quality mark awarded by TÜV Rheinland **FR** Label de qualité décerné par TÜV Rheinland **ES** Marca de calidad concedida por TÜV Rheinland **HR** Oznaka kvalitete dodijeljena od strane TÜV Rheinland **HU** A TÜV Rheinland által kiállított minőségi védjegy **RO** Semnul de calitate acordat de TÜV Rheinland **BG** Знак за качество, присъден от TÜV Rheinland



DE Griff aus Holz EN Wooden handle **FR** Manche en bois **ES** Mango de madera **HR** Drvena ručka **HU** Fa fogantyú **RO** Mâner din lemn **BG** Дървена дръжка



DE Metall und Inox EN Metal and inox **FR** Métal et inox **ES** Metal e inox **HR** Metal i inox **HU** Fém és inox **RO** Metal și inox **BG** Метал и иннок



DE Glasmesserg Griff aus Holz EN Wooden handle of a glass cutter **FR** Manche de coupe-verre en bois **ES** Mango de madera para cortadores de vidrio **HR** Drvena ručka noža za staklo **HU** Fa üvegvágó kés nyél **RO** Mâner din lemn pentru cuțit de tăiat sticlă **BG** Дървена дръжка за стъкло



DE Aluminium-Kopf EN Aluminum head **FR** Tête en aluminium **ES** Cabezal de aluminio **HR** Aluminijaska glava **HU** Alumínium fej **RO** Cap din aluminiu **BG** Алуминиева глава



DE Härtegrad des Stahls nach der Rockwell-Skala EN The level of hardness of steel according to the Rockwell scale **FR** Niveau de dureté de l'acier selon l'échelle de Rockwell **ES** Nivel de dureza del acero según la escala Rockwell **HR** Razina tvrdoće čelika po Rockwellu **HU** Az acél Rockwell-skála szerinti keménységi szintje **RO** Nivelul de duritate a oțelului conform scalei Rockwell **BG** Нивото на твърдост на стоманата по скалата на Рокуел



DE Griff aus Hickoryholz EN Hickory wood handle **FR** Manche en bois de hickory **ES** Mango de madera de nogal americano **HR** Ručka od hikorijevog drva **HU** Hickory fanyél **RO** Mâner din lemn de nuc american **BG** Дръжка от дърво от хикори



DE Kopf aus Zinkdruckguss EN Die-cast zinc head **FR** Tête en zinc moulé **ES** Cabeza de fundición de zinc **HR** Glava od cinkovog odljevka **HU** Öntött cink fej **RO** Cap din zinc turnat **BG** Цинкова глава, отлита от цинк



DE Härtegrad der Klingen nach der Rockwell-Skala EN The level of hardness of the blades according to the Rockwell scale **FR** Niveau de dureté des lames selon l'échelle de Rockwell **ES** Nivel de dureza del cuchillas según la escala Rockwell **HR** Razina tvrdoće oštrica po Rockwellu **HU** A pengék Rockwell-skála szerinti keménységi szintje **RO** Nivelul de duritate al lamelor în conformitate cu scara Rockwell **BG** Нивото на твърдост на остриетата според скалата на Рокуел



DE Griff aus Fiberglas EN Fiberglass handle **FR** Manche en fibre de verre **ES** Mango de fibra de vidrio **HR** Ručka od staklenog vlakna **HU** Üvegszálas nyél **RO** Mâner din fibră de sticlă **BG** Дръжка от фибростъкло



DE Schutzklasse III (bei Beleuchtung) EN Protection class III (in lighting) **FR** Classe de protection III (en éclairage) **ES** III Clase de protección (en iluminación) **HR** III Klasa zaštite (za rasvjetu) **HU** III. védelmi osztály (világítás) **RO** Klasa de protecție III (în iluminat) **BG** Клас на защита III (осветление)



DE Härtebereich des Stahls nach der Rockwell-Skala EN The range of steel hardness according to the Rockwell scale **FR** Gamme de dureté de l'acier selon l'échelle de Rockwell **ES** Rango de dureza del acero según la escala Rockwell **HR** Raspon tvrdoće čelika po Rockwellu **HU** Az acél Rockwell-skála szerinti keménységi tartománya **RO** Gama de duritate a oțelului în conformitate cu scara Rockwell **BG** Диапазонът на твърдост на стоманата според скалата на Рокуел



DE Holz EN Wood **FR** Bois **ES** Madera **HR** Drvo **HU** Fa **RO** Lemn **BG** Дърво



DE Schutzklasse II (bei Beleuchtung) EN Protection class II (in lighting) **FR** Classe de protection II (en éclairage) **ES** II Clase de protección (en iluminación) **HR** II Klasa zaštite (za rasvjetu) **HU** II. védelmi osztály (világítás) **RO** Klasa de protecție II (în iluminat) **BG** Клас на защита II (осветление)



DE Hartholz EN Hard wood **FR** Bois dur **ES** Madera dura **HR** Tvrd drvo **HU** Keményfa **RO** Lemn de esență tare **BG** Твърдо дърво



DE III. Messgenauigkeitsklasse EN III Measurement accuracy class **FR** Classe de précision de mesure III **ES** III Clase de precisión de la medición **HR** III Klasa točnosti mjerenja **HU** III. mérési pontossági osztály **RO** Clasa de precizie a măsurătorilor III **BG** III Клас на точност на измерване



DE Härtebereich der Backen nach der Rockwell-Skala EN Jaw hardness range according to the Rockwell scale **FR** Gamme de dureté des mâchoires selon l'échelle de Rockwell **ES** Rango de dureza de la mandíbula según la escala Rockwell **HR** Raspon tvrdoće čeljusti po Rockwellu **HU** A pofák Rockwell-skála szerinti keménységi tartománya **RO** Gama de duritate a fălcilor în conformitate cu scara Rockwell **BG** Диапазон на твърдост на стъга според скалата на Рокуел



DE Weichholz EN Soft wood **FR** Résineux **ES** Madera blanda **HR** Meko drvo **HU** Puhafa **RO** Lemn de esență moale **BG** Меко дърво



DE II. Genauigkeitsklasse EN II Accuracy class **FR** Classe de précision II **ES** II Clase de precisión **HR** II klasa točnosti **HU** II. pontossági osztály **RO** Clasa de precizie II **BG** Клас на точност II



DE Laminat EN Laminate **FR** Stratifié **ES** Laminado **HR** Laminat **HU** Laminátum **RO** Laminat **BG** Ламиниран паркет



DE Härtebereich der Backen nach der Rockwell-Skala EN Jaw hardness range according to the Rockwell scale **FR** Gamme de dureté des mâchoires selon l'échelle de Rockwell **ES** Rango de dureza de la mandíbula según la escala Rockwell **HR** Raspon tvrdoće čeljusti po Rockwellu **HU** A pófák Rockwell-skála szerinti keménységi tartománya **RO** Gama de duritate a făcilor în conformitate cu scara Rockwell **BG** Диапазон на твърдост на стъги според скалата на Рокуел



DE Härte der Klinge nach der Rockwell-Skala EN Blade hardness according to the Rockwell scale **FR** Dureté de la lame selon l'échelle de Rockwell **ES** Dureza de hoja según la escala Rockwell **HR** Raspon tvrdoće oštrice po Rockwellu **HU** A penge Rockwell-skála szerinti keménysége **RO** Duritatea lamei în conformitate cu scara Rockwell **BG** Твърдост на острието по скалата на Рокуел



DE Härte des Kabels nach der Rockwell-Skala EN Cable hardness according to Rockwell scale **FR** Dureté du câble selon l'échelle de Rockwell **ES** Dureza del cable según la escala Rockwell **HR** Tvrdoća kabla po Rockwellu **HU** A kábel Rockwell-skála szerinti keménysége **RO** Duritatea cablului în conformitate cu scara Rockwell **BG** Твърдост на кабела по скалата на Рокуел



DE Härtebereich des Sägeblatts nach der Rockwell-Skala EN Saw blade hardness range according to the Rockwell scale **FR** Gamme de dureté de la lame selon l'échelle de Rockwell **ES** Rango de dureza de las cuchillas según la escala Rockwell **HR** Raspon tvrdoće lista po Rockwellu **HU** A racsni Rockwell-skála szerinti keménységi tartománya **RO** Gama de duritate a lamei în conformitate cu scara Rockwell **BG** Диапазон на твърдост на острието по скалата на Рокуел



DE Härtebereich des Sägeblatts nach der Rockwell-Skala EN Saw blade hardness range according to the Rockwell scale **FR** Gamme de dureté de la lame selon l'échelle de Rockwell **ES** Rango de dureza de las cuchillas según la escala Rockwell **HR** Raspon tvrdoće lista po Rockwellu **HU** A racsni Rockwell-skála szerinti keménységi tartománya **RO** Gama de duritate a lamei în conformitate cu scara Rockwell **BG** Диапазон на твърдост на острието по скалата на Рокуел



DE Härtebereich des Beils nach der Rockwell-Skala EN Head hardness range according to the Rockwell scale **FR** Gamme de dureté de la tête selon l'échelle de Rockwell **ES** Rango de dureza de la cabeza según la escala Rockwell **HR** Raspon tvrdoće glave po Rockwellu **HU** A fej Rockwell-skála szerinti keménységi tartománya **RO** Gama de duritate a capului în conformitate cu scara Rockwell **BG** Диапазон на твърдост на форма на Rockwell



DE Dichtheitsnorm - Schutz gegen Staub und Feuchtigkeit EN Tighness standard - protection against dust and moisture **FR** Norme d'étanchéité - protection contre la poussière et l'humidité **ES** Norma de estanqueidad: protección contra el polvo y la humedad **HR** Standard nepropusnosti - zaštita od prašine i vlage **HU** Vizáltság szabvány - por és nedvesség elleni védelem **RO** Standard de etanșeitate - protecție împotriva prafului și umezelii **BG** Стандарт за пълнот - защита срещу прах и влага



DE Das Produkt entspricht der Europäischen Messgeräterichtlinie EN The product complies with the European directive about measuring instruments **FR** Le produit est conforme à la directive européenne sur les instruments de mesure **ES** Producto cumple con la Directiva Europea de Instrumentos de Medida **HR** Proizvod zadovoljava europski standard za mjernu instrumente **HU** A termék megfelel a mérőműszerekről szóló európai irányelvnek **RO** Produsul este în conformitate cu Directiva europeană privind instrumentele de măsură **BG** Продуктът отговаря на европейската директива за измервателните уреди



DE IP55 Schutz gegen Staub und Feuchtigkeit EN IP55 tightness standard - protection against dust and moisture **FR** Norme d'étanchéité IP55 Protection contre la poussière et l'humidité **ES** Grado de protección IP55 contra el polvo y la humedad **HR** Standard nepropusnosti IP55 zaštita od prašine i vlage **HU** IP55 por és nedvesség elleni védelem norma **RO** Standard de etanșeitate IP55 împotriva prafului și umidității **BG** IP55 пълнот стандартна защита срещу прах и влага



DE Sechseckige Spitze EN Hexagonal bit **FR** Embout hexagonal **ES** Hoja hexagonal **HR** Šesterokutni vrh **HU** Hatszögletű bit **RO** Vârf hexagonal **BG** Шестъгълна върх



DE Schmale Spitze EN Narrow bit **FR** Embout étroit **ES** Punta estrecha **HR** Uski vrh **HU** Keskeny bit **RO** Vârf îngust **BG** Тясен върх



DE Innensechskantschlüssel mit sechseckigem Durchmesser EN Allen key with a hexagonal cross-section **FR** Clé Allen hexagonale **ES** Llave de vaso hexagonal **HR** Šesterokutni imbus ključ **HU** Hatszögletű keresztmetszetű imbuszkulcs **RO** Cheie imbus hexagonală **BG** Имбусен ключ с шестъгълно напречно сечение



DE Innensechskantschlüssel mit sechseckigem Durchmesser mit Öffnung EN Allen key with a hexagonal cross-section with a hole **FR** Clé Allen hexagonale avec alésage **ES** Llave hexagonal con agujero **HR** Šesterokutni imbus ključ s otvorom **HU** Hatszögletű keresztmetszetű imbuszkulcs furattal **RO** Cheie imbus hexagonală cu gaură **BG** Имбусен ключ с шестъгълно напречно сечение с отвор



DE Innensechskantschlüssel mit sechseckigem Durchmesser EN Allen key with a hexagonal cross-section **FR** Clé Allen hexagonale **ES** Llave de vaso hexagonal **HR** Šesterokutni imbus ključ **HU** Hatszögletű keresztmetszetű imbuszkulcs **RO** Cheie imbus hexagonală **BG** Имбусен ключ с шестъгълно напречно сечение



DE Innensechskantschlüssel mit sechseckigem Durchmesser EN Allen key with a hexagonal cross-section **FR** Clé Allen hexagonale **ES** Llave de vaso hexagonal **HR** Šesterokutni imbus ključ **HU** Hatszögletű keresztmetszetű imbuszkulcs **RO** Cheie imbus hexagonală **BG** Имбусен ключ с шестъгълно напречно сечение



DE Kugelförmiger Innensechskantschlüssel mit sechseckigem Durchmesser EN Spherical Allen key with a hexagonal cross-section **FR** Clé Allen sphérique hexagonale **ES** Llave de vaso redondo hexagonal **HR** Šesterokutni loptasti imbus ključ **HU** Gömb alakú hatszögletű keresztmetszetű imbuszkulcs **RO** Cheie imbus rotundă cu secțiune transversală hexagonală **BG** Сферичен Имбусен ключ с шестъгълно напречно сечение



DE Kreuzspitze, für Kreuzschlitz-Schraubendreher EN Cross bit, for screwdrivers with Phillips recess **FR** Embout cruciforme, pour tournevis à empreinte Phillips **ES** Punta en cruz, para destornilladores con ranura Phillips **HR** Križni bit za odvijače Phillips **HU** Kereszt csavarhúzó vég, Phillips fejú csavarokhoz **RO** Vârf în cruce, pentru șurubelnițe cu cap încastrat Phillips **BG** Кръстосано острие, за отвертки с вдлъбнатина Phillips



DE Kreuzspitze für Pozidriv-Schlitzschraubendreher EN Cross bit, for screwdrivers with Pozidriv recess **FR** Embout cruciforme, pour tournevis à empreinte Pozidriv **ES** Punta en cruz, para destornilladores con ranura Phillips Pozidriv **HR** Križni bit za odvijače Pozidriv **HU** Kereszt csavarhúzó vég, Pozidriv csavarokhoz **RO** Vârf în cruce, pentru șurubelnițe cu cap încastrat Pozidriv **BG** Кръстосано острие за отвертки Pozidriv



DE Kreuzspitzen für Pozidriv- und Phillips-Schraubendreher EN Cross bits, for screwdrivers with Phillips recess **FR** Embouts cruciformes, pour tournevis Pozidriv et Phillips **ES** Punta en cruz, para destornilladores con ranura Phillips Pozidriv y Phillips **HR** Križni bit za odvijače Pozidriv i Phillips **HU** Kereszt csavarhúzó vég, Pozidriv és Phillips csavarokhoz **RO** Vârfuluri în cruce, pentru șurubelnițe Pozidriv și Phillips **BG** Кръстосани битове за отвертки Pozidriv и Phillips



DE Sternspitze EN Star bit **FR** Embout étoile **ES** Punta de cruz **HR** Zvezdasti bit **HU** Kereszt csavarhúzó vég **RO** Vârf stea **BG** Звездна глава



DE Klebepistole EN Glue gun **FR** Pistolet à colle **ES** Pistola de pegamento **HR** Pištolj za ljepljenje **HU** Melegasztós pisztoly **RO** Pistolet pentru adeziv **BG** Пистолет за лепило



DE Klingenlagerung im Rahmen EN Saw blade storage in the frame **FR** Dépôt de lames dans le cadre **ES** Almacenamiento de la cuchilla en el marco **HR** Spremnik listova za pile u okviru **HU** Fűrészlaptartó a keretben **RO** Depozitarea pânzelor de ferăstrău în cadrul **BG** Съхранение на режещия диск в рамката



DE Scheibenarbeit bei 90° EN Cutting disc operation at an angle of 90° **FR** Travail du disque à 90° **ES** Funcionamiento de los discos a 90° **HR** Rad diskom pod nagibom 90° **HU** 90°-ban működő tárcsa **RO** Discuri de lucru la un unghi de 90° **BG** Работа с диск под ъгъл 90°



DE Ratschen EN Ratchets **FR** Cliquets **ES** Carracas **HR** Čegrtljke **HU** Racsnis hajtókarok **RO** Chei cu clichet **BG** Тресчотки



DE Mehrzweckzange EN Universal pliers **FR** Pince multi-usages **ES** Alicates multiusos **HR** Univerzalna špic ključa **HU** Univerzális fogó **RO** Clește multifuncțional **BG** Универсални клещи



DE Seitenschneider EN Side pliers **FR** Pince latérale **ES** Cortadores laterales **HR** Bočna špic ključa **HU** Oldalsóipró fogó **RO** Clește lateral **BG** Странични клещи



DE Verlängerungszange EN Elongated pliers **FR** Pince allongée **ES** Alicates alargados **HR** Produžena špic ključa **HU** Hosszúcsőrű fogó **RO** Clește alungit **BG** Клещи удължени



DE Seitliche Präzisionszangen EN Side precision pliers **FR** Pince de précision latérale **ES** Alicates de precisión laterales **HR** Bočna precizna špic ključa **HU** Oldalsó preciziós fogók **RO** Clește lateral de precizie **BG** Странични прецизни клещи



DE Mehrzweck-Präzisionszange EN Precision universal pliers **FR** Pince de précision multi-usages **ES** Alicates multiusos de precisión **HR** Univerzalna precizna špic ključa **HU** Univerzális preciziós fogók **RO** Clește de precizie multifuncțional **BG** Прецизни универсални клещи



DE Präzisionszange verlängert EN Precision pliers elongated **FR** Pince de précision allongée **ES** Alicates de precisión, alargados **HR** Produžena precizna špic ključa **HU** Preciziós hosszúcsőrű fogók **RO** Clește de precizie alungit **BG** Прецизни клещи удължени



DE Vordere Präzisionszange EN Precision nose pliers **FR** Pince de précision avant **ES** Alicates de precisión frontales **HR** Prednja čeona špic ključa **HU** Preciziós homlokcsípőfogók **RO** Clește de precizie frontal **BG** Прецизни клещи за нос



DE Gerändelte Klinge EN Knurled bit **FR** Embout moleté **ES** Hoja moleteada **HR** Bit s brazdama **HU** Recézt csavarhúzóbit **RO** Vârf zimțat **BG** Набразден върх



DE Gerader Schnitt EN Straight cutting **FR** Coupe droite **ES** Corte recto **HR** Ravni rez **HU** Egyenes vágás **RO** Taietură dreaptă **BG** Права кройка



DE Mit Daumen halten EN Hold with your thumb **FR** Tenir avec le pouce **ES** Mantener pulsado el pulgar **HR** Pridržati palcom **HU** Tartsa a hüvelykujjával **RO** Țineți cu degetul mare **BG** Дръжте го с палец



DE Säge mit auswechselbarem Blatt EN Saw with replaceable saw blade **FR** Scie avec lame amovible **ES** Sierra con hoja intercambiable **HR** Pila sa izmjenjivim listom **HU** Fűrész cserélhető fűrészlappal **RO** Fierăstrău cu pânză interschimbabilă **BG** Трион със сменяем листове



DE Beidseitig geschliffene Klinge EN Double-sided sharpened blade **FR** Lame à double tranchant **ES** Cuchilla afilada de doble cara **HR** Oštrica s dvostranim oštrenjem **HU** Kétoldalt élezett penge **RO** Lamă ascuțită pe două fețe **BG** Двойно заточено острие



DE Dreiseitig geschliffene Klinge **EN** Three-sided sharpened blade **FR** Lame à triple tranchant **ES** Cuchilla afilada por tres lados **HR** Oštrica s trostranim oštrenjem **HU** Háromoldalt élezett penge **RO** Lamă ascuțită pe trei fețe **BG** Трискрано заточено острие



DE Spitze auf drei Knaufenden **EN** Bit on the three ends of the knob **FR** Embout sur trois extrémités du bouton **ES** Cuchilla en tres extremos del pomo **HR** Bit na tri kraja gumba **HU** Csa-varhúzó vég a nyél három végén **RO** Vârf pe trei capete de buton **BG** Накрайник на трите края на копчето



DE Ratschenmechanismus mit 52 Zähnen **EN** Ratchet mechanism with 52 teeth **FR** Mécanisme à cliquet avec 52 dents **ES** Carraca de 52 dientes **HR** Okidni mehanizam čegrtaljke s 52 zuba **HU** 52 fogas racsnis mechanizmus **RO** Mecanism cu clichet cu 52 de dinți **BG** Механизъм на тресчотка с 52 зъба



DE Ratschenmechanismus mit 60 Zähnen **EN** Ratchet mechanism with 60 teeth **FR** Mécanisme à cliquet avec 60 dents **ES** Carraca de 60 dientes **HR** Okidni mehanizam čegrtaljke s 60 zuba **HU** 60 fogas racsnis mechanizmus **RO** Mecanism cu clichet cu 60 de dinți **BG** Механизъм на тресчотка с 60 зъба



DE Ratschenmechanismus mit 72 Zähnen **EN** Ratchet mechanism with 72 teeth **FR** Mécanisme à cliquet avec 72 dents **ES** Carraca de 72 dientes **HR** Okidni mehanizam čegrtaljke s 72 zuba **HU** 72 fogas racsnis mechanizmus **RO** Mecanism cu clichet cu 72 de dinți **BG** Храпови механизъм със 72 зъба



DE Ratsche mit durchgehendem Kopf **EN** Pass-through ratchet **FR** Cliquet traversant **ES** Carraca recta **HR** Okasta čegrtaljka **HU** Átengedős racsni **RO** Clichet de trecere **BG** Проходно тресчотка



DE Breite Backenabstände **EN** Wide jaw spacing **FR** Large espacement des mâchoires **ES** Gran ancho de mandíbula **HR** Široki razmak čeljusti **HU** Széles pofatávolság **RO** Spațiere largă a fălcilor **BG** Широк отвор на челюстта



DE 1/4" Schnellverschlusskupplung **EN** 1/4" quick coupler **FR** Raccord rapide 1/4" **ES** 1/4" acoplamiento rápido **HR** Brza spojnica 1/4" **HU** 1/4" gyorscsatlakozó **RO** cuplaj rapid 1/4" **BG** 1/4" бърз съединител



DE Länge der Düse **EN** Nozzle length **FR** Longueur de la buse **ES** Longitud de la boquilla **HR** Dužina mlaznice **HU** Fúvóka hosszúság **RO** Lungimea duzei **BG** Дължина на дюзата



DE Länge der Druckleitung **EN** Length of the pressure hose **FR** Longueur du tuyau de pression **ES** Longitud de la línea de presión **HR** Dužina tlačnog voda **HU** A nyomástovábbító cső hossza **RO** Lungimea conductei de presiune **BG** Дължина на маркуча за налягане



DE Innendurchmesser und Außendurchmesser **EN** Inner diameter and outer diameter **FR** Diamètre intérieur et diamètre extérieur **ES** Diámetro interior y exterior **HR** Unutarnji promjer i vanjski promjer **HU** Belső átmérő és külső átmérő **RO** Diametrul interior și diametrul exterior **BG** Вътрешен и външен диаметър



DE 40000 Betriebsstunden **EN** 40,000 working hours **FR** 40000 heures de fonctionnement **ES** 40000 horas de funcionamiento **HR** 40000 sati rada **HU** 40000 munkóra **RO** 40000 ore de funcționare **BG** 40 000 работни часа



DE Bis zu 200000 Ein- und Ausschaltvorgänge **EN** Up to 200,000 on and off switches **FR** Jusqu'à 200 000 marche/arrêt **ES** Hasta 200 000 encendidos/apagados **HR** Do 200000 uključivanja i isključivanja **HU** Akár 200000 be/ki kapcsolás **RO** Până la 200000 de porniri/opriiri **BG** До 200 000 включения и изключения



DE Energieklasse **EN** Type of energy class **FR** Type de classe énergétique **ES** Tipo de clase energética **HR** Vrsta energetskog razreda **HU** Energiaosztály típus **RO** Tipul clasei energetice **BG** Тип енергийн клас



DE Ohne Batterie **EN** Without battery **FR** Sans pile **ES** Sin pila **HR** Bez baterija **HU** Elem nélkül **RO** Fără baterii **BG** Без батерии



DE Eine AA-Batterie **EN** One AA battery **FR** Une pile AA **ES** Una pila AA **HR** Jedna baterija AA **HU** Egy AA elem **RO** O baterie AA **BG** Една батерия тип AA



DE Messgenauigkeit **EN** Accuracy of measurement **FR** Précision de la mesure **ES** Precisión de las mediciones **HR** Točnost mjerenja **HU** Mérési pontosság **RO** Precizia măsurătorilor **BG** Точност на измерване



DE Schiebeknopf **EN** Sliding knob **FR** Bouton coulissant **ES** Pomo deslizante **HR** Klizna poluga **HU** Eltolható gomb **RO** Buton glisant **BG** Плъзгащо се копче



DE Einstellung der Schnitttiefe **EN** Cutting depth adjustment **FR** Réglage de la profondeur de l'encoche **ES** Ajuste de la profundidad de la muesca **HR** Regulacija dubine ureza **HU** A vágási mélység beállítása **RO** Reglarea adâncimii creșteriturii **BG** Регулиране на дълбочината на прреза



DE Stoßdämpfende Endkappen **EN** Shakes absorbing covers **FR** Embouts absorbant les chocs **ES** Tapas de extremo con absorción de impactos **HR** Zaštitne kapice na krajevima za apsorpciju udaraca **HU** Ütéscsillapító végzáró sapkák **RO** Capace de capăt cu amortizare a șocurilor **BG** Крайни корпусу за амортизация



DE Automatischer Klingenzug **EN** Function of automatic blade retraction **FR** Fonction de rétraction automatique de la lame **ES** Función de retracción automática de la hoja **HR** Funkcija automatskog uvlačenja oštrice **HU** Automatikus penge visszahúzási funkció **RO** Funcția de retragere automată a lamei **BG** Автоматична функция за прибиране на острие



DE Sicherheitsgurtschneider-Funktion **EN** Function of safety seat belt cutting **FR** Fonction de coupe de ceinture de sécurité **ES** Función de corte del cinturón de seguridad **HR** Funkcija rezanja sigurnosnog pojasa **HU** Biztonsági övágó funkció **RO** Funcția de tăiere a centurii de siguranță **BG** Функция за рязане на ленти за безопасност



DE Funktion der Klingenauswerfsperre **EN** Function of blocking blade sliding out **FR** Fonction de verrouillage de l'éjection de la lame **ES** Función de bloqueo de expulsión de la hoja **HR** Funkcija blokade izvlačenja oštrice **HU** Pengékitolás blokkoló funkció **RO** Funcția de blocare a ejecției lamei **BG** Блокиране на изваждане на острие



DE Klingenauswurf-Sperrfunktion mit Klingenlängeneinstellung **EN** Function of blocking blade sliding out with adjustable blade length **FR** Fonction de verrouillage de l'éjection de la lame avec réglage de sa longueur **ES** Función de bloqueo de la hoja con ajuste de la longitud de la hoja **HR** Funkcija blokade izvlačenja oštrice s regulacijom njezine dužine **HU** Pengékitolás blokkoló funkció pengehossz beállításal **RO** Funcția de blocare a ejecției lamei cu reglarea lungimii lamei **BG** Блокиране на изваждане на острие с регулация на дължина



DE Klebpatrone schwarz **EN** Black glue cartridge **FR** Cartouche de colle noire **ES** Cartucho de pegamento negro **HR** Patrona s ljepliom crne boje **HU** Fekete ragasztópisztoly betét **RO** Rezervă de lipici negru **BG** Вложка лепило черно



DE Profilierter 4x90° Bohrkopf **EN** 4x90° profiled drill head **FR** Tête de forage profilée 4x90° **ES** Perfil 4x90° cabeza de perforación **HR** Profilirana glava svrdla 4x90° **HU** Profilozott 4x90° fúrófej **RO** Cap de burghiu profilat 4x90° **BG** 4x90° профилирано свредло



DE Zusätzliche Spiralen an der Kante der Bohrkronen **EN** Additional spirals at the edge of the drill **FR** Spirales supplémentaires sur le bord du foret **ES** Espirales adicionales en el borde de la broca **HR** Dodatne spirale na rubu svrdla **HU** Kiegészítő spirálak a fúrószár szélén **RO** Spirale suplimentare pe marginea burghuiului **BG** Допълнителни спирали по ръба на свредлото



DE Klemmen vom Typ Clic und Clic-R **EN** Clic and Clic-R clamps **FR** Bornes de type Clic et Clic-R **ES** Terminales de tipo Clic y Clic-R **HR** Stezaljke tip Clic i Clic-R **HU** Clic és Clic-R típusú terminálok **RO** Terminale de tip Clic și Clic-R **BG** Щипки Clic и Clic-R



DE Durchgehende Diamantscheibe **EN** Continuous diamond wheel blade **FR** Disque diamanté continu **ES** Disco diamantado continuo **HR** Dijamantni disk za kontinuirani rad **HU** Folyamatos gyémánttárcsa **RO** Disc diamantat continuu **BG** Диамантен диск постоянно



DE LED-Beleuchtung in der Magnetspitze **EN** LED lighting mounted in the magnetic tip **FR** Éclairage LED incorporé dans la pointe magnétique **ES** Iluminación LED incorporada en el extremo magnético **HR** LED rasvjeta ugrađena u magnetni nastavak **HU** LED világítás a mágneses hegybe integrálva **RO** Iluminat cu LED-uri încorporat în capătul magnetic **BG** LED осветление, монтирано в магнитния връх



DE Großes und übersichtliches Display **EN** Large and clear display **FR** Affichage large et clair **ES** Pantalla grande y clara **HR** Veliki i pregledni zaslon **HU** Nagy és jól olvasható kijelző **RO** Afişaj mare și clar **BG** Голям и ясен дисплей



DE Aufzeichnung der letzten 20 Messungen **EN** Records last 20 measurements **FR** Enregistrement des 20 dernières mesures **ES** Registro de las últimas 20 mediciones **HR** Snimanje 20 posljednjih mjerenja **HU** Az utolsó 20 mérés rögzítése **RO** Înregistrarea ultimelor 20 de măsurători **BG** Записва последните 20 измервания



DE Anzahl der Betriebssysteme **EN** Quantity of operating systems **FR** Nombre de systèmes d'exploitation **ES** Número de sistemas operativos **HR** Broj operativnih sustava **HU** Az operációs rendszerek száma **RO** Numărul de sisteme de operare **BG** Брой операционни системи



DE Messung mit dem Entfernungsmesser **EN** Rangefinder measurement **FR** Mesure du télémètre **ES** Medición con telémetro **HR** Mjerenje daljinometrom **HU** A távolságmérő mérése **RO** Măsurarea telemetrului **BG** Измерване на далекомер



DE Abisolierzange mit Schneider **EN** Wire stripper with cutter **FR** Pince à dénuder avec coupe-file **ES** Alicates de pelar con cortador **HR** Špic klijesta za skidanje izolacije s rezačem **HU** Kábelcsupaszító csípőfogó vágóval **RO** Clește de dezizolat fire cu tăietor **BG** Клещи за сваляне на изолация с нож



DE Stahldrahtabisolierzange mit Schneider **EN** Wire stripper with steel cutter **FR** Pince à dénuder avec coupe-file en acier **ES** Alicates para pelar con cortador de tubos de acero **HR** Špic klijesta za skidanje izolacije s čeličnim rezačem **HU** Kábelcsupaszító csípőfogó acél vágóval **RO** Clește de dezizolat sârmă cu tăietor de oțel **BG** Клещи за сваляне на изолация с нож от стомана



DE Abisolierzange mit Schneider **EN** Wire stripper with cutter **FR** Pince à dénuder avec coupe-file **ES** Alicates de pelar con cortador **HR** Špic klijesta za skidanje izolacije s rezačem **HU** Kábelcsupaszító csípőfogó vágóval **RO** Clește de dezizolat fire cu tăietor **BG** Клещи за сваляне на изолация с нож



DE SK5 Stahlschneider **EN** SK5 steel cutter **FR** Coupe-file en acier SK5 **ES** Cortadora de acero SK5 **HR** Rezač čelični SK5 **HU** SK5 acél vágó **RO** Tăietor de oțel SK5 **BG** Нож от стомана SK5



DE Abisolierzange mit Schneider EN Wire stripper with cutter
FR Pince à dénuder avec coupe-fil **ES** Alicates de pelar con cortador **HR** Špic klijesta za skidanje izolacije s rezačem
HU Kábelcsupaszító csipőfogó vágóval **RO** Clește de deizolat fire cu tăietor **BG** Клещи за свяляне на изолация с нож



DE Abisolierzange mit Schneider EN Wire stripper with cutter
FR Pince à dénuder avec coupe-fil **ES** Alicates de pelar con cortador **HR** Špic klijesta za skidanje izolacije s rezačem
HU Kábelcsupaszító csipőfogó vágóval **RO** Clește de deizolat fire cu tăietor **BG** Клещи за свяляне на изолация с нож



DE Kerbe in der Schere zum einfachen Schneiden von Kabeln EN Eension in the scissors to facilitate cutting the wires **FR** Encoche dans les ciseaux pour faciliter la coupe des câbles **ES** Muesca en la cizalla para facilitar el corte de los cables **HR** Izrez u škarama za lakše rezanje vodova **HU** Bevágás az ollópengékben a kábeltek könnyebb átvágásához **RO** Crestătură în foarfecă pentru tăierea ușoară a cablurilor **BG**



DE LED Chip On Board Technologie, Leistung 3 W EN LED Made in Chip On Board technology, power 3 W **FR** LED dans la technologie Chip On Board, puissance 3 W **ES** Tecnología de chip LED en placa, potencia 3 W **HR** LED u tehnologiji Chip On Board, snage 3 W **HU** Chip On Board technológiájú LED, 3 W teljesítményű **RO** LED in tehnologia Chip On Board, putere 3 W **BG** LED изработен в технология Chip on Board, мощ 3W



DE Gesenkgeschmiedet EN Drop forged **FR** Forgeage à matrice **ES** Forjado en gota **HR** Kovano u ukovnju **HU** Alakosan sajtoló **RO** Forjat cu matrice **BG** Кована по матрицо



DE Presse mit doppeltem Verriegelungsmechanismus EN Mass squeezer with double locking mechanism **FR** Pistolet de mastic à double mécanisme de verrouillage **ES** Exprimidor de doble acción con bloqueo **HR** Pištolj za istiskivanje mase s dvostrukim mehanizmom blokade **HU** Kinyomósztoly kétetős blokkoló mechanizmussal **RO** Pistol pentru mase cu mecanism de blocare dublu **BG** Пистолет за смеси с двоен заключващ механизъм



DE Langlebige Gelenke EN Durable universal joint **FR** Joints durables **ES** Juntas duraderas **HR** Trajni zglobovi **HU** Tartós csuklók **RO** Articulații durabile **BG** Устойчиви стави



DE Einfacher Klingenwechsel EN Easy blade change **FR** Remplacement facile de la lame **ES** Cambio fácil de las cuchillas **HR** Jednostavna zamjena oštrice **HU** Könnyű pengecseré **RO** Înlocuire ușoară a lamei **BG** Лесна смяна на острието



DE Einfaches Crimpen EN Easy clamping **FR** Sertissage facile **ES** Fácil de engazar **HR** Lako zatezanje **HU** Könnyen összenyomható **RO** Sertizare ușoară **BG** Лесно зацягане



DE Ergonomischer Griff EN Ergonomic handle **FR** Manche ergonomique **ES** Asa ergonómica **HR** Ergonomska ručka **HU** Ergonomikus markolat **RO** Mâner ergonomic **BG** Ергономична дръжка



DE Ergonomische Verpackung EN Ergonomic packaging **FR** Emballage ergonomique **ES** Embalaje ergonómico **HR** Ergonomska ambalaža **HU** Ergonomikus csomagolás **RO** Ambalaj ergonomic **BG** Ергономична опаковка



DE Sechskantflansch an der Basis des Griffs EN Hex collar at the handle root **FR** Bride hexagonale à la base de la manche **ES** Brides hexagonal en la base del mango **HR** Šesterokutna prirobnica na spoju ručke **HU** Hatszögletű karima a markolat tövével **RO** Flanșă hexagonală la baza mânerului **BG** Шестъгълна яка в основата на дръжката



DE Elastische Spitze EN Flexible bit **FR** Embout flexible **ES** Cuchilla flexible **HR** Elastičan vrh **HU** Rugalmas hegy **RO** Vârf flexibil **BG** Гъвкав накрайник



DE Für Lichtwellenleiter EN For optical fibers **FR** Pour les fibres optiques **ES** Para fibras ópticas **HR** Za optičke kablove **HU** Száloptikához **RO** Pentru fibre optice **BG** За оптични влакна



DE Für Dieselfahrzeuge EN For cars with diesel engines **FR** Pour les voitures diesel **ES** Para los vehículos diésel **HR** Za automobile s dizelskim motorima **HU** Dizelüzemű személygépkocsikhoz **RO** Pentru autoturisme diesel **BG** За автомобили с дизелови двигатели



DE Für Trommeln EN For drum brakes **FR** Pour les freins à tambour **ES** Para frenos de tambor **HR** Za bubanj kočnice **HU** Dobfékekhez **RO** Pentru frâne cu tambur **BG** За барабанны спирачки



DE Präzise EN Precise **FR** Précision **ES** Preciso **HR** Precizan **HU** Precíz **RO** De precizie **BG** Прецизно



DE Rosetten-Kombizange EN Rosette pliers connection **FR** Pince avec une connexion à rosette **ES** Alicates de rosetas articuladas **HR** Ojačani spoj klijesta (rozetna) **HU** Rozettás fogó csatlakozás **RO** Clește cu rozetă **BG** Розетна връзка на клещи



DE Niederdruck-Spritzpistolen EN Low pressure spray guns **FR** Pistolets de peinture à basse pression **ES** Pistolas de baja presión **HR** Niskotlačni pištolj za lakiranje **HU** Alacsony nyomású festőpisztolyok **RO** Pistoale de pulverizare de joasă presiune **BG** Пистолети за лакиране с ниско налягане



DE Gürtelclip EN Belt hook **FR** Clip de ceinture **ES** Clip para el cinturón **HR** Kopča za remen **HU** Övcsipesz **RO** Clemă pentru curea **BG** Щипка за колан



DE Öffnung zum Aufhängen der Säge EN Anging hole for the saw **FR** Trou pour suspendre la scie **ES** Agujero para colgar la sierra **HR** Otvor za vješanje pile **HU** Fűrész felakasztó furat **RO** Gaură pentru agățarea fierăstrăului **BG** Отвор за поставяне на триона



DE Für innen EN For inwards **FR** Pour l'intérieur **ES** Hacia el interior **HR** Prema unutra **HU** Befelű **RO** Spre interior **BG** Вънтрешно



DE Jumbo-Schlagwerk EN umbo hammer mechanism **FR** Mécanisme à percussion Jumbo **ES** Mecanismo de impacto Jumbo **HR** Udarni mehanizam Jumbo **HU** Jumbo ütőmechanizmus **RO** Mecanism de impact Jumbo **BG** Jumbo чуков механизъм



DE LED-Technologie EN LED technology **FR** Technologie LED **ES** Tecnología LED **HR** Tehnologija LED **HU** LED technológia **RO** Tehnologie LED **BG** LED технология



DE LED-Technologie, Leistung 3 W EN LED technology, power 3 W **FR** Technologie LED, puissance 3 W **ES** Tecnología LED, potencia 3 W **HR** Tehnologija LED, snaga 3 W **HU** LED technológia, 3 W teljesítményű **RO** Tehnologie LED, putere 3 W **BG** LED технология, мощност 3 W



DE Getöntes Glas - Stufe 6 EN Tinted glass - level 6 **FR** Vitres teintées - niveau 6 **ES** Cristales tintados - nivel 6 **HR** Zatamnjena stakla - razina 6 **HU** Sötétített üveg - 6. szint **RO** Geamuri fumurii - nivel 6 **BG** Тонирано стъкло - ниво 6



DE Licht EN Light **FR** Léger **ES** Ligero **HR** Lagane **HU** Könnyű **RO** Ușoare **BG** Леки



DE Rückschlagfeder EN Rebound spring **FR** Ressort de rebond **ES** Muelle de rebote **HR** Tlačna opruga **HU** Visszaütő rugó **RO** Arc reflex **BG** Отскочна пружина



DE Niedriges Profil EN Low profile **FR** Profil bas **ES** Perfil bajo **HR** Niski profil **HU** Alacsony profil **RO** Profil jos **BG** Нисък профил



DE 6-facher Gliedermaßstab EN 6-segment foldable rule **FR** Mesure pliable à 6 segments **ES** Medida plegable de 6 piezas **HR** Sklopivi meter 6-dijelni **HU** 6 részes összehajtható mérőlévél **RO** Riglă pliabilă 6 segmente **BG** 6-сегментно съвмаемо правило



DE 10-facher Gliedermaßstab EN 10-segment foldable rule **FR** Mesure pliable à 10 segments **ES** Medida de plegado de 10 elementos **HR** Sklopivi meter 10-dijelni **HU** 10 részes összehajtható mérőlévél **RO** Riglă pliabilă 10 segmente **BG** Правило за съвмаемо от 10 сегмента



DE Stahlende am Griff zum Anschlagen EN Steel ending on the handle, used for striking **FR** Extrémité du manche en acier pour frapper **ES** Extremo de acero en el mango para golpear **HR** Čelični vrh ručke za udaranje **HU** A markolat acél vége kalapáccsal üthető **RO** Capăt din oțel al mânerului pentru batere **BG** Стоманен край на дръжката, използван за удране



DE Lange, schattierte Backen EN Long thin jaws **FR** Longues mâchoires rétrécies **ES** Mandíbulas largas y finas **HR** Duge čeljusti smanjene debljine **HU** Hosszú, vékonyított pófák **RO** Fâci Lungi și subțiri **BG** Дълги тънки стъги



DE Magnethalter mit Innenmagnet EN Magnetic holder with an internal magnet **FR** Support magnétique avec aimant intérieur **ES** Soporte magnético con imán interior **HR** Magneta drška s unutarnjim magnetom **HU** Mágneses felszedő belső mágnessel **RO** Suport magnetic cu magnet interior **BG** Магнитен държач с вътрешен магнит



DE Magnetische Schraubendreher Spitze EN Magnetic screwdriver bit **FR** Embout magnétique de tournevis **ES** Hoja de destornillador magnética **HR** Magnetni bit odvijачa **HU** Mágneses csavarhúzó vég tartó **RO** Bit magnetic pentru șurubelniță **BG** Накрайник на магнитна отвертка



DE Magnetbasis der Wasserwaage EN The magnetic base of the spirit level **FR** Base de niveau magnétique **ES** Base de nivel magnético **HR** Magneta baza libele **HU** Mágneses szintmérő alap **RO** Bază magnetică nivelă cu bulă de aer **BG** Магнитната основа на нивелира



DE Magnetischer Messhaken EN Magnetic hook tape measure **FR** Crochet de mesure magnétique **ES** Grifo magnético de medición **HR** Magnetni držac metra **HU** Mágneses mérőszalag vég **RO** Cârlig magnetic pentru ruletă de măsurat **BG** Магнитна ролетка



DE Ankerbolzen Typ EN Anchor bolt type **FR** Type de vis d'ancrage **ES** Tipo de perno de anclaje **HR** Vrsta sidrenog vijka **HU** Horgonycsavar típusa **RO** Tip bolt de ancorare **BG** Тип анкерни болтове



DE Gefräste Seitenkante der Wasserwaage EN Milled side edge of the spirit level **FR** Bord latéral fraisé du niveau à bulle **ES** Borde fresado del nivel de burbuja **HR** Glodani bočni rub libele **HU** Hornyolt szintmérő oldalsó ét **RO** Margine laterală frezată a nivelei cu bulă de aer **BG** Фрезоз страничен ръб на нивелира



DE Zwei gefräste Seitenkanten der Wasserwaage EN Two side edges of the spirit level are milled **FR** Deux bords latéraux fraisés du niveau à bulle **ES** Dos bordes laterales del nivel de burbuja fresados **HR** Glodana dva bočna ruba libele **HU** Kétoldalt hornyolt szintmérő ét **RO** Două margini laterale frezate ale nivelei cu bulă de aer **BG** Два странични ръба на нивелира са фрезозани



DE Teflon-Beschichtung EN Teflon shell **FR** Couche en téflon **ES** Revestimiento de teflón **HR** Teflonski premaz **HU** Teflon bevonat **RO** Înveliș de teflon **BG** Тефлоново покритие



DE Kompaktes Maß im Taschenformat **EN** Pocket tape measure, small size **FR** Règle compacte au format de poche **ES** Medida compacta de bolsillo **HR** Džepni metar malih dimenzija **HU** Kompakt zsebméretű mérőszalag **RO** Ruletă de măsură compactă, de buzunar **BG** Джебна мярка, малък размер



DE Drehbarer Haken **EN** Rotating hook **FR** Crochet rotatif **ES** Gancho giratorio **HR** Okretna kuka **HU** Forgatható horgo **RO** Cârlig rotativ **BG** Въртяща се кука



DE Ratsche in Standardverzahnung **EN** Ratchet splined standard **FR** Cliquet à cannelure multiple **ES** Carraca estándar del estriado **HR** Čegrtaljka u standardu s više izvoda **HU** Többcsatlakozós szabványú racsni **RO** Cheie cu clichet în standard cu canelură **BG** Тресчотка с шлицован механизми



DE Bits in Standardverzahnung **EN** Sockets in splined standard **FR** Douilles à cannelure multiple **ES** Tomas de corriente estándar con estrías **HR** Nastavci u standardu s više izvoda **HU** Többcsatlakozós szabványú aljzat **RO** Capuri chei tubulare în standard cu canelură **BG** Вложки с шлицован стандарт



DE Selbstzentrierendes Bohren **EN** Self-centering drilling **FR** Percage autocentré **ES** Perforación autocentrante **HR** Samo-centrirajuće bušenje **HU** Önközpontosított fúrás **RO** Perforare cu autocentrare **BG** Самоцентриращо се бурване



DE Mechanismus zum schnellen Lösen des Bits **EN** Socket quick release mechanism **FR** Mécanisme d'ouverture rapide de la douille **ES** Mecanismo de cierre rápido de la tapa **HR** Mehanizam brzog otpuštanja nastavka **HU** Gyorskioldó mechanizmusú aljzat **RO** Mecanism de eliberare rapidă a capului **BG** Механизъм за бързо освобождаване на вложки



DE Auszugssperre **EN** Lock of tape opening **FR** Verrouillage du ruban éjecté **ES** Dispositivo de bloqueo de la cinta extendida **HR** Blokada izvučene mjerne trake **HU** Kihúzott szalag blokkolás **RO** Blocarea benzii extrase **BG** Блокиране на изхвърлената лента



DE Kurzer Griff **EN** Short handle **FR** Manche courte **ES** Asa corta **HR** Kratka ručka **HU** Rövid fogantyú **RO** Mâner scurt **BG** Къса дръжка



DE SOS- und ZOOM-Funktionen **EN** SOS and ZOOM functions **FR** Fonctions SOS et ZOOM **ES** Funciones SOS y ZOOM **HR** SOS i ZOOM funkcije **HU** SOS és ZOOM funkciók **RO** Funcțiile SOS și ZOOM **BG** SOS и ZOOM функции



DE Dünne Scheibe **EN** A thin wheel blade **FR** Disque mince **ES** Disco fino **HR** Disk male debljine **HU** Kis vastagságú tárcsa **RO** Disc subțire **BG** Тънък диск



DE Abisoliermesser **EN** Wire stripper **FR** Lame de dénudage **ES** Cuchilla de despiece **HR** Oštrica za skidanje izolacije **HU** Szigetelés eltávolító penge **RO** Cuțit de deizolat cabluri **BG** Острие за сваляне на тел



DE USB-Anschluss **EN** USB port **FR** Port USB **ES** Puerto USB **HR** USB port **HU** USB port **RO** Port USB **BG** USB порт



DE Die Oberfläche kann gestrichen werden **EN** The surface can be painted **FR** La surface peut être peinte **ES** La superficie se puede pintar **HR** Površina može biti obojena **HU** Fehető felület **RO** Suprafața poate fi vopsită **BG** Поверхността може да бъде боядисана



DE Weiß **EN** White **FR** Blanc **ES** Blanco **HR** Bijeli **HU** Fehér **RO** Alb **BG** Бял



DE Beil mit Vakuum **EN** A head with a vacuum **FR** Tête à vide **ES** Aspiración al vacío **HR** Glava s vakuumom **HU** Vákuum fej **RO** Aspiratie prin vid **BG** Форма с вакуум



DE Hammer mit Keil **EN** Hammer with a wedge **FR** Marteau avec cale **ES** Martillo con cuña **HR** Čekić s klinom **HU** Kalapács ékkel **RO** Ciocan cu pană **BG** Чук с клин



DE Der Hammer beschädigt das Werkstück nicht **EN** The hammer does not damage the processed material **FR** Le marteau n'endommage pas la pièce à travailler **ES** Martillo no daña la pieza **HR** Čekić ne uzrokuje oštećenje obrađivanog materijala **HU** A kalapács nem roncsolja a munkadarabot **RO** Ciocanul nu deteriorează piesa de lucru **BG** Чукът не уврежда обработения материал



DE Der Hammer hinterlässt keinen Schmutz **EN** The hammer leaves no dirt **FR** Le marteau ne laisse pas de saleté **ES** Martillo no deja manchas **HR** Čekić ne ostavlja tragove prljavštine **HU** A kalapács nem hagy szennyeződést **RO** Ciocanul nu lasă murdărie **BG** Чукът не оставя мръсотия



DE Schwarz-weißes Gummibeil **EN** Black and white rubber head **FR** Tête en caoutchouc noir et blanc **ES** Cabeza de goma blanca y negra **HR** Glava od crno-bijele gume **HU** Fekete-fehér gumirozott fej **RO** Cap de cauciuc alb-negru **BG** Черно-бяла гумена глава



DE 2 Organizer **EN** 2 organizers **FR** 2 compartiments **ES** 2 organizadores **HR** 2 organizatora **HU** 2 szervező **RO** 2 organizatori **BG** 2 организатора



DE Abnehmbares Tablett **EN** Removable tray **FR** Plateau amovible **ES** Bandeja extraíble **HR** Zamjenjiva tacna **HU** Kivehető tábla **RO** Tavă detașabilă **BG** Подвижна тава



DE Schlaufe zum Aufhängen von Werkzeugen **EN** Loop for hanging tools **FR** Boucle pour suspendre les outils **ES** Bucle para colgar de herramientas **HR** Petljica za vješanje alata **HU** Hurok a szerszámok felakasztásához **RO** Bucă pentru agățarea uneltelor **BG** Примка за окачване на инструменти



DE Spannange **EN** Collet **FR** Collet de serrage **ES** Collet **HR** Zatezna čahura **HU** Befogópatron **RO** Manșon de prindere **BG** Патроник



DE Steckverbinder, isolierte Hülsen **EN** Connector, slip-on sleeves **FR** Connecteur, douilles isolées **ES** Conector, manguitos desizantes **HR** Konektor, izolirane stopice **HU** Csatlakozó, szigetelt kábelvégek **RO** Conector, prize izolate **BG** Съединител, изолирани ръкави



DE Spannange **EN** Collet **FR** Collet de serrage **ES** Collet **HR** Stezna čahura **HU** Befogópatron **RO** Manșon de prindere **BG** Патроник



DE Typ des Kabelendes **EN** Type of cable end **FR** Type d'extrémité de câble **ES** Tipo de terminal de cable **HR** Vrsta kablenskog završetka **HU** Kábelvég típusa **RO** Tip capăt de cablu **BG** Тип на края на кабела



DE Typ des Kabelendes **EN** Type of cable end **FR** Type d'extrémité de câble **ES** Tipo de terminal de cable **HR** Vrsta kablenskog završetka **HU** Kábelvég típusa **RO** Tip capăt de cablu **BG** Тип на края на кабела



DE Typ des Kabelendes **EN** Type of cable end **FR** Type d'extrémité de câble **ES** Tipo de terminal de cable **HR** Vrsta kablenskog završetka **HU** Kábelvég típusa **RO** Tip capăt de cablu **BG** Тип на края на кабела



DE Typ des Kabelendes **EN** Type of cable end **FR** Type d'extrémité de câble **ES** Tipo de terminal de cable **HR** Vrsta kablenskog završetka **HU** Kábelvég típusa **RO** Tip capăt de cablu **BG** Тип на края на кабела



DE Typ des Kabelendes **EN** Type of cable end **FR** Type d'extrémité de câble **ES** Tipo de terminal de cable **HR** Vrsta kablenskog završetka **HU** Kábelvég típusa **RO** Tip capăt de cablu **BG** Тип на края на кабела



DE Kabelsteckverbinder **EN** Cable connector **FR** Connecteur de câble **ES** Conector del cable **HR** Kablovski konektor **HU** Kábelcsatlakozó **RO** Conector de cablu **BG** Кабелен конектор



DE Zylindrischer Steckverbinder **EN** Cylindrical connector **FR** Connecteur cylindrique **ES** Conectores cilíndricos **HR** Cilindrični konektor **HU** Hengeres csatlakozó **RO** Conector cilindric **BG** Цилиндричен конектор



DE Ösensteckverbinder **EN** Ring connector **FR** Connecteur à œil **ES** Conectores de ojal **HR** Konektor okasti **HU** Gyűrűs csatlakozó **RO** Conector cu ochi **BG** Конектор за пръстен



DE Gerader Schnitt **EN** Straight cutting **FR** Coupe droite **ES** Corte recto **HR** Rezanje pravolinijsko **HU** Egyenes vonalú vágás **RO** Taiere dreaptă **BG** Пряволинейно рязане



DE Gebogener Schnitt **EN** Curvilinear cut **FR** Coupe courbe **ES** Corte curvo **HR** Rezanje krivolinijsko **HU** Íves vonalú vágás **RO** Taiere curbă **BG** Криволинейно изрязване



DE Sauberer gebogener Schnitt **EN** Clear curvilinear cut **FR** Coupe nette et courbe **ES** Corte curvo limpio **HR** Čisto krivolinijsko rezanje **HU** Tiszta íves vonalú vágás **RO** Taiere curbă curată **BG** Чисто криволинейно изрязване



DE Extreme Kurvenschnitte **EN** Cutting on extreme curves **FR** Coupes de courbes extrêmes **ES** Cortes en curvas extremas **HR** Rezanje po ekstremnim lukovima **HU** Extrém íves vágás **RO** Taieri pe curbe extreme **BG** Рязане по екстремни крайни криви



DE Schneller Schnitt **EN** Quick cutting **FR** Coupe rapide **ES** Corte de alta velocidad **HR** Brzo rezanje **HU** Gyors vágás **RO** Taiere rapidă **BG** Бързо рязане



DE Sauberer Schnitt **EN** Clear cutting **FR** Coupe nette **ES** Corte limpio **HR** Čisto rezanje **HU** Tiszta vágás **RO** Taiere curată **BG** Чисто изрязване



DE Sauberer Schnitt beim Trimmen **EN** Clean cut during trimming **FR** Coupe nette lors de la découpe **ES** Corte limpio al re-cortar **HR** Čisto rezanje kod izrezivanja **HU** Tiszta vágás kivágásnál **RO** Taiere curată la finisare **BG** Чисто рязане при подрязване



DE Milliampere-stunde **EN** Milliampere hour **FR** Milliampère-heure **ES** Milliampérior-hora **HR** Milliampersat **HU** Milliampóra **RO** Milliampere oră **BG** Ампер час



DE Breite des Bands **EN** The width of the tape **FR** Largeur du ruban **ES** Ancho de banda **HR** Širina trake **HU** Szalag szélesség **RO** Lățimea benzii **BG** Ширината на лентата



DE Länge der Teleskopverbindung **EN** The length of the telescopic joint steering shaft **FR** Longueur du joint télescopique **ES** Longitud de la junta telescópica **HR** Dužina teleskopskog zgloba **HU** A teleszkópos csukló hossza **RO** Lungimea articulației telescopice **BG** Дължината на телескопичната стяга



DE Länge des Kabels **EN** Cable length **FR** Longueur du câble **ES** Longitud del cable **HR** Dužina voda **HU** Kábel hosszúság **RO** Lungimea cablului **BG** Дължина на кабела



DE Länge des Bands **EN** The length of the tape **FR** Longueur du ruban **ES** Longitud del cinturón **HR** Dužina trake **HU** Szalag hosszúság **RO** Lungimea benzii **BG** Дължината на лентата



DE Beleuchtungsreichweite bis zu 200 m **EN** Lighting range up to 200 m **FR** Capacité d'éclairage jusqu'à 200 m **ES** Alcance de la iluminación hasta 200 m **HR** Domet rasvjeta do 200 m **HU** Világítási tartomány 200 m-ig **RO** Raza de iluminare de până la 200 m **BG** Обхват на осветление до 200 м



DE Maximale Backenöffnung **EN** maximum jaw opening **FR** Ouverture maximale des mâchoires **ES** Apertura máxima de las mandíbulas **HR** Maksimalni razmak čeljusti **HU** Maximális rofanyitás **RO** Deschiderea maximă a fălcii **BG** Максимум отваряне на стаята



DE Maximale Backenöffnung **EN** maximum jaw opening **FR** Ouverture maximale des mâchoires **ES** Apertura máxima de las mandíbulas **HR** Maksimalni razmak čeljusti **HU** Maximális rofanyitás **RO** Deschiderea maximă a fălcii **BG** Максимум отваряне на стаята



DE Höhe der trapezförmigen Klinge **EN** The height of the trapezoidal blade **FR** Hauteur de la lame trapézoïdale **ES** Altura de la hoja trapezoidal **HR** Visina trapezne oštrice **HU** A trapéz penge magassága **RO** Înălțimea lamei trapezoidale **BG** Височината на трапезно острие



DE Größe der trapezförmigen Klinge **EN** Trapezoidal blade size **FR** Taille de la lame trapézoïdale **ES** Tamaño de la hoja trapezoidal **HR** Veličina trapezne oštrice **HU** A trapéz penge mérete **RO** Dimensiunea lamei trapezoidale **BG** Размер на на трапезно острие



DE Minimaler Arbeitsbereich des hydraulischen Wagenhebers **EN** The minimum working range of a hydraulic post jack **FR** Plage de travail minimale du cric hydraulique **ES** Alcance mínimo de trabajo del elevador hidráulico **HR** Minimalni radni raspon hidraulične dizalice **HU** A hidraulikus emelő minimális munkatartománya **RO** Intervalul minim de lucru al ascensorului hidraulic **BG** Минималният работен обхват на хидравличния крик



DE Maximaler Arbeitsbereich des hydraulischen Wagenhebers **EN** Maximum working range of a hydraulic jack post **FR** Plage de travail maximale du cric hydraulique **ES** Alcance máximo de funcionamiento del elevador hidráulico **HR** Maksimalni radni raspon hidraulične dizalice **HU** A hidraulikus emelő maximális munkatartománya **RO** Intervalul maxim de lucru al ascensorului hidraulic **BG** Максимален работен обхват на хидравличния крик



DE Minimaler Arbeitsbereich des Säulenhebers **EN** The minimum working range of a post jack **FR** Plage de travail minimale du cric bouteille **ES** Alcance mínimo del elevador de columna **HR** Minimalni radni raspon stupne dizalice **HU** Az oszlopemelő minimális munkatartománya **RO** Intervalul minim de lucru al ascensorului de stâlpi **BG** Минималният работен обхват на хидравличния крик



DE Maximaler Arbeitsbereich des Säulenhebers **EN** Maximum working range of a post jack **FR** Plage de travail maximale du cric bouteille **ES** Alcance máximo del elevador de columna **HR** Maksimalni radni raspon stupne dizalice **HU** Az oszlopemelő maximális munkatartománya **RO** Intervalul maxim de lucru al ascensorului de stâlpi **BG** Максимален работен обхват на хидравличния крик



DE Maßeinheit für den Druck **EN** Unit of measure for pressure **FR** Unité de mesure de la pression **ES** Unidad de medida de la presión **HR** Jedinica mjerenja tlaka **HU** A nyomás mértékegysége **RO** Unitatea de măsură a presiunii **BG** Мерна единица за налягане



DE Lichtfarbe **EN** The color of the light **FR** Couleur de la lumière **ES** Color de la luz **HR** Boja svjetla **HU** A fény színe **RO** Culoarea luminii **BG** Цветът на светлината



DE Maßeinheit des Lichtstroms **EN** Unit of measurement for the luminous flux **FR** Unité de mesure du flux lumineux **ES** Unidad de medida del flujo luminoso **HR** Jedinica mjere svjetlosnog snopa **HU** A fénysugár mértékegysége **RO** Unitatea de măsură a fluxului luminos **BG** Мерна единица за светлинния поток



DE Druckeinheit (Pfund pro Quadratzoll) **EN** Pressure unit (pound per square inch) **FR** Unité de pression (livre par pouce carré) **ES** Unidad de presión (libra por pulgada cuadrada) **HR** Jedinica tlaka (pound per square inch) **HU** Nyomás mértékegysége (font/négyzet hüvelyk) **RO** Unitatea de presiune (pound per square inch) **BG** Единица за налягане



DE Mikrometer **EN** Micrometer **FR** Micromètre **ES** Micrómetro **HR** Mikrometar **HU** Mikrométer **RO** Micrometru **BG** Микрометър



DE Mikrometer **EN** Micrometer **FR** Micromètre **ES** Micrómetro **HR** Mikrometar **HU** Mikrométer **RO** Micrometru **BG** Микрометър



DE Niutonmeter **EN** Newton meter **FR** Niutonmètre **ES** Niu-tómetro **HR** Njutnmetar **HU** Newtonómetér **RO** Niutonometr **BG** Нютон метър



DE Durchmesser des Rohrs **EN** Pipe diameter **FR** Diamètre du tuyau **ES** Diámetro del tubo **HR** Promjer cijevi **HU** Csőátmérő **RO** Diametrul țevii **BG** Диаметър на тръбата



DE Arbeitsbereich der Innenzange **EN** Working range of internal pliers **FR** Plage de travail des pinces intérieures **ES** Rango de funcionamiento de las pinzas interiores **HR** Radni raspon unutarnjih kliješta **HU** A belső fogó munkatartománya **RO** Intervalul de funcționare a cleștilor interioari **BG** Работен диапазон на вътрешни клещи



DE Arbeitsbereich der Außenzange **EN** Working range of external pliers **FR** Plage de travail des pinces extérieures **ES** Rango de funcionamiento de los alicates exteriores **HR** Radni raspon vanjskih kliješta **HU** A külső fogó munkatartománya **RO** Intervalul de funcționare a cleștilor exteriori **BG** Работен диапазон на външни клещи



DE Durchmesser des Bohrers **EN** Drill diameter **FR** Diamètre du foret **ES** Diámetro de la broca **HR** Promjer svrdla **HU** Fűrő átmérő **RO** Diametrul burghiului **BG** Диаметър на свердолото



DE Durchmesser des Zwei-Stufen-Bohrers **EN** Two-step drill diameter **FR** Diamètre du foret à deux étages **ES** Diámetro de la broca de dos etapas **HR** Promjer dvostupanjskog svrdla **HU** Két-fokozatú fűrőfő átmérő **RO** Diametrul burghiului în două etape **BG** Диаметър на двустепенно свердело



DE Durchmesser des Klebstoffs **EN** Glue diameter **FR** Diamètre de la colle **ES** Diámetro de la cola **HR** Promjer ljeplja **HU** Melegragasztó átmérő **RO** Diametrul de lipire **BG** Диаметър на лепилото



DE Scheibendurchmesser **EN** Wheel blade diameter **FR** Diamètre du disque **ES** Diámetro del disco **HR** Promjer diska **HU** Tárcsa átmérő **RO** Diametrul discului **BG** Диаметър на циферблата



DE Querschnitt der stromführenden Leitung **EN** Cross-section of the electrical cable **FR** Section transversale du fil conducteur **ES** Sección transversal de la línea de conducción de corriente **HR** Presjek strujnog voda **HU** Áramvezető vezeték keresztmetszete **RO** Secțiunea transversală a firului de curent **BG** Напречно сечение на токовия проводник



DE Querschnitt der stromführenden Leitung **EN** Cross-section of the electrical cable **FR** Section transversale du fil conducteur **ES** Sección transversal de la línea de conducción de corriente **HR** Presjek strujnog voda **HU** Áramvezető vezeték keresztmetszete **RO** Secțiunea transversală a firului de curent **BG** Напречно сечение на токовия проводник



DE Maximaler Durchmesser **EN** Maximum diameter **FR** Diamètre maximal **ES** Diámetro máximo **HR** Maksimalni promjer **HU** Maximális átmérő **RO** Diametrul maxim **BG** Максимален диаметър



DE Maximaler Rohrdurchmesser **EN** Maximum pipe diameter **FR** Diamètre maximal du tuyau **ES** Diámetro máximo del tubo **HR** Maksimalni promjer cijevi **HU** Maximális csőátmérő **RO** Diametrul maxim al țevii **BG** Максимален диаметър на тръбата



DE Größen der Ausdreher **EN** Sizes of screw extractors **FR** Tailles des extracteurs **ES** Tamaños de los extractores de tornillo **HR** Veličina ekstraktora vijaka **HU** A csavarhúzó méretei **RO** Dimensiunile extractoarelor **BG** Размери на отвертки



DE 30 % leichter **EN** 30% lighter **FR** 30% plus légers **ES** 30% más ligero **HR** 30% lakši **HU** 30%-kal könnyebb **RO** 30% mai ușoară **BG** 30% по-лека



DE Gewichtseinheit, 1 Kilogramm **EN** Unit of mass, 1 kilogram **FR** Unité de poids, 1 kilogramme **ES** Unidad de masa, 1 kilogramo **HR** Jedinica mase, 1 kilogram **HU** Tömeg mértékegység, 1 kg **RO** Unitate de greutate, 1 kilogram **BG** Единица за тегло, 1 килограм



DE Gewichtseinheit, 5 Kilogramm **EN** Unit of mass, 5 kilograms **FR** Unité de poids, 5 kilogrammes **ES** Unidad de masa, 5 kilogramos **HR** Jedinica mase, 5 kilograma **HU** Tömeg mértékegység, 5 kilogramm **RO** Unitate de greutate, 5 kilograme **BG** Единица за тегло, 5 килограма



DE Gewichtseinheit 2 Tonnen **EN** Mass unit 2 tons **FR** Unité de poids 2 tonnes **ES** Unidad de masa 2 toneladas **HR** Jedinica mase 2 tone **HU** Súly mértékegység 2 tonna **RO** Unitate de greutate 2 tone **BG** Единица за тегло, 2 тона



DE Maximale Belastung **EN** Maximum loading **FR** Charge maximale **ES** Carga máxima **HR** Maksimalno opterećenje **HU** Maximális terhelés **RO** Sarcina maximă **BG** Максимално натоварване



DE Maximales Gewicht 12 Kilogramm **EN** Maximum weight 12 kilograms **FR** Poids maximum 12 kilogrammes **ES** Masa máxima 12 kilogramos **HR** Maksimalna masa 12 kilograma **HU** Maximális súly 12 kilogramm **RO** Greutate maximă 12 kilograme **BG** Максимално тегло 12 кг



DE Maximale Belastung **EN** Maximum loading **FR** Charge maximale **ES** Carga máxima **HR** Maksimalno opterećenje **HU** Maximális terhelés **RO** Sarcina maximă **BG** Максимално натоварване



DE Klebstoffverbrauch in Gramm pro Minute **EN** Glue consumption capacity in grams per minute **FR** Consommation de colle en grammes par minute **ES** Capacidad de consumo de cola en gramos por minuto **HR** Učinkovitost potrošnje ljeplila grama u minuti **HU** A ragasztófogyasztás teljesítménye grammban percenként **RO** Consumul de adeziv în grame pe minut **BG** Производителност на консумация на лепило в грамове/минута



DE Kapazität der Spritzpistole **EN** Spray gun efficiency **FR** Capacité du pistolet de peinture **ES** Rendimiento de la pistola **HR** Učinkovitost pistolja za lakiranje **HU** A festékpisztoly teljesítménye **RO** Capacitatea pistolului de pulverizare **BG** Производителност на pistolета за ЛАКИРАНЕ



DE Luftverbrauch der Spritzpistole **EN** Spray gun air intake **FR** Consommation d'air du pistolet de peinture **ES** Consumo de aire de la pistola **HR** Potrošnja zraka pistolja za lakiranje **HU** A festékpisztoly levegőfogyasztása **RO** Consumul de aer al pistolului de pulverizare **BG** Всмукване на въздух от пулверизатор



DE Messgenauigkeit der Wasserwaage **EN** The accuracy of the level measurements **FR** Précision de mesure du niveau à bulle **ES** Precisión de la medición del nivel **HR** Točnost mjerenja libele **HU** A vízmérték mérési pontossága **RO** Precizia de măsurare a nivelului cu bulă de aer **BG** Точността на измерванията на нивелир



DE 3 Libellen in der Wasserwaage EN 3 vials in the spirit level
FR 3 indicateurs dans le niveau à bulles **ES** 3 viates en el nivel de burbuja **HR** Libela 3 u 1 **HU** 3 libella a vízmértéken **RO** 3 bule în nivela cu bulă de aer **BG** 3 либели в нивелира



DE 2 Libellen in der Wasserwaage EN 2 vials in the spirit level
FR 2 indicateurs dans le niveau à bulles **ES** 2 viates en el nivel de burbuja **HR** Libela 2 u 1 **HU** 2 libella a vízmértéken **RO** 2 bule în nivela cu bulă de aer **BG** 2 либели в нивелира



DE Spitzenwinkel des Bohrers EN Point angle of the drill **FR** Angle de la pointe du foret **ES** Ángulo de punta de la broca **HR** Kut oštrenja svrdla **HU** Fúróhegy szöge **RO** Unghiul vârfului burghiului **BG** Точков ъгъл на сверделото



DE Drehbarer Schraubstockfuß EN Swivel base of vice **FR** Base d'étai pivotante **ES** Base giratoria para mordazas **HR** Okretna baza škripcia **HU** Elfördítható satu alátét **RO** Bază de mențină pivotantă **BG** Въртяща се основа на менгемето



DE Drehen des Rohrs EN Rotating the tube **FR** Rotation du tube **ES** Girar el tubo **HR** Okretanje tube **HU** Cső elforgatás **RO** Rotirea tubului **BG** Завъртане на тръбата



DE Minimaler Schnittbereich für Metall EN Minimum metal cutting range **FR** Plage de coupe minimale des métaux **ES** Rango mínimo de corte de metal **HR** Minimalni raspon rezanja metala **HU** Minimális fémvágási tartomány **RO** Intervalul minim de tăiere a metalelor **BG** Минимален диапазон на рязане на метал



DE Minimaler Schnittbereich für MDF EN Minimum cutting range of MDF **FR** Plage de coupe minimale du MDF **ES** Rango mínimo de corte de MDF **HR** Minimalni raspon rezanja MDF-a **HU** Minimális MDF vágási tartomány **RO** Intervalul minim de tăiere MDF **BG** Минималният диапазон на рязане на MDF



DE Minimaler Schnittbereich für Fliesen EN Minimum glaze cutting range **FR** Plage de coupe minimale des carreaux **ES** Alcance mínimo de corte de baldosas **HR** Minimalni raspon rezanja keramičkih ploča **HU** Minimális csempe vágási tartomány **RO** Intervalul minim de tăiere a plăcilor ceramice **BG** Минимален диапазон на рязане за глазура



DE Minimaler Schnittbereich für Holz EN Minimum wood cutting range **FR** Plage de coupe minimale du bois **ES** Alcance mínimo de corte de madera **HR** Minimalni raspon rezanja drveta **HU** Minimális fa vágási tartomány **RO** Interval minim de tăiere a lemnului **BG** Минимален диапазон на рязане на дърва



DE Maximaler Schnittbereich für Holz EN Maximum wood cutting range **FR** Plage de coupe maximale du bois **ES** Alcance máximo de corte de madera **HR** Maksimalni raspon rezanja drveta **HU** Maximális fa vágási tartomány **RO** Interval maxim de tăiere a lemnului **BG** Максимален обхват на рязане на дърва



DE Maximaler Schnittbereich für Fliesen EN Maximum glaze cutting range **FR** Plage de coupe maximale des carreaux **ES** Alcance máximo de corte de baldosas **HR** Maksimalni raspon rezanja keramičkih ploča **HU** Maximális csempe vágási tartomány **RO** Intervalul maxim de tăiere a plăcilor ceramice **BG** Максималният обхват на рязане на глазура



DE Maximaler Schnittbereich für Metall EN Maximum metal cutting range **FR** Plage de coupe maximale des métaux **ES** Capacidad máxima de corte de metal **HR** Maksimalni raspon rezanja metala **HU** Maximális fém vágási tartomány **RO** Intervalul maxim de tăiere a metalelor **BG** Максимален обхват на рязане на метал



DE Maximale Kabeldicke EN Maximum cable thickness **FR** Épaisseur maximale du câble **ES** Espesor máximo del cable **HR** Maksimalna debljina kabla **HU** Maximális kábelvastagság **RO** Grosimea maximă a cablului **BG** Максимална дебелина на кабела



DE Maximaler Schnittbereich für MDF EN Maximum cutting range of MDF **FR** Plage de coupe maximale du MDF **ES** Alcance máximo de corte de MDF **HR** Maksimalni raspon rezanja MDF-u **HU** Maximális MDF vágási tartomány **RO** Intervalul maxim de tăiere MDF **BG** Максимален диапазон на рязане на MDF



DE Reduzierter Zentrierpunkt der Fräse EN Milling cutter with reduced centering point **FR** Point de centrage de la fraise réduit **ES** Punto central de recogida reducido **HR** Reducirana točka za centriranje glodanja **HU** Redukált központozító marási pont **RO** Punct central redus de preluare **BG** Точката на центриране на фрезата е намалена



DE Gewinkelte und gerade Klemmringverschraubungen EN Straight and angular compression connectors **FR** Raccords à compression droits et angulaires **ES** Racores de compresión, acodados y rectos **HR** Kompresijske spojnice kutne i ravne **HU** Egyenes és sarok kompressziós csatlakozók **RO** Racorduri de compresie înclinată și drepte **BG** Прави и ъглови компресионни дуги



DE Verschraubung EN Connectors **FR** Raccord **ES** Conector **HR** Spojnica **HU** Csatlakozó **RO** Conector **BG** Съединител



DE 6-Pin-Kabel EN Cable 6 pins **FR** Câble à 6 broches **ES** Cable de 6 pines **HR** Kabel 6-pinski **HU** 6 pines kábel **RO** Cablu cu 6 pini **BG** 6 -пинов кабел



DE 8-Pin-Kabel EN Cable 8 pins **FR** Câble à 8 broches **ES** Cable de 8 pines **HR** Kabel 8-pinski **HU** 8 pines kábel **RO** Cablu cu 8 pini **BG** 8 -пинов кабел



DE 4-Pin-, 6-Pin-, 8-Pin-, 10-Pin-Kabel EN Cables 4 pin, 6 pin, 8 pin, 10 pin **FR** Câbles 4 broches, 6 broches, 8 broches, 10 broches **ES** Cables de 4, 6, 8 y 10 pines **HR** Kablovi 4-pinski, 6-pinski, 8-pinski, 10-pinski **HU** 4, 6, 8, 10 pines kábelek **RO** Cabluri 4 pini, 6 pini, 8 pini, 10 pini **BG** 4 -пинов, 6 -пинов, 8 -пинов, 10 -пинов кабел



DE (RJ45) Stecker EN (RJ45) Plug **FR** (RJ45) Fiche **ES** Enchufe (RJ45) **HR** (RJ45) Utikač **HU** (RJ45) dugó **RO** (RJ45) Conector **BG** (RJ45) Щенсел



DE (RJ9, RJ11, RJ12, RJ45) Steckers EN (RJ9, RJ11, RJ12, RJ45) Plugs **FR** (RJ9, RJ11, RJ12, RJ45) Fiches **ES** Enchufes (RJ9, RJ11, RJ12, RJ45) **HR** (RJ9, RJ11, RJ12, RJ45) Utikači **HU** (RJ9, RJ11, RJ12, RJ45) csatlakozók **RO** (RJ9, RJ11, RJ12, RJ45) Conectoare **BG** (RJ9, RJ11, RJ12, RJ45) Щенсели



DE (RG-59 RG-6 Tri-set-113) Koaxialkabel EN (RG-59 RG-6 Tri-set-113) Concentric cable **FR** (RG-59 RG-6 Tri-set-113) Câble coaxial **ES** (RG-59 RG-6 Tri-set-113) Cable coaxial **HR** ((RG-59 RG-6 Tri-set-113) Koncentrični kabel **HU** (RG-59 RG-6 Tri-set-113) Koaxiális kábel **RO** (RG-59 RG-6 Tri-set-113) Cablu coaxial **BG** (RG-59 RG-6 Tri-set-113) Коаксиален кабел



DE Gummischlauch EN Rubber wire **FR** Tuyau en caoutchouc **ES** Manguera de goma **HR** Gumeni vod **HU** Gumitömlő **RO** Furtun de cauciuc **BG** Гумен кабел



DE Anzahl der Zähne pro Zoll EN Q-ty of teeth per inch **FR** Nombre de dents par pouce **ES** Número de dientes por pulgada **HR** Broj zubi po inču **HU** Fogak száma hüvelykenként **RO** Numărul de dinți pe inch **BG** Брой зъби на инч



DE Anzahl der Zähne pro Zoll des Holzsaägeblatts EN Q-ty of teeth per inch of straight saw blade for wood **FR** Nombre de dents par pouce de la lame de scie à bois **ES** Número de dientes por pulgada de la hoja de sierra para madera **HR** Broj zubi po inču na listu za drvo **HU** A fa fűrészlap fogainak száma hüvelykenként **RO** Numărul de dinți pe centimetru al pânzei de ferăstrău pentru lemn **BG** Брой зъби на инч на трион за дърво



DE Anzahl der Zähne pro Zoll des Metallsägeblatts EN Q-ty of teeth per inch of straight saw blade for metal **FR** Nombre de dents par pouce de la lame de scie à métaux **ES** Número de dientes por pulgada de la hoja de sierra metálica **HR** Broj zubi po inču na listu za metal **HU** A fémvágó fűrészlap fogainak száma hüvelykenként **RO** Numărul de dinți pe centimetru al pânzei de ferăstrău pentru metal **BG** Зъби на инч от метален трион



DE Anzahl der Zähne pro Zoll des Metallsägeblatts EN Q-ty of teeth per inch of straight saw blade for metal **FR** Nombre de dents par pouce de la lame de scie à métaux **ES** Número de dientes por pulgada de la hoja de sierra metálica **HR** Broj zubi po inču na listu za metal **HU** A fémvágó fűrészlap fogainak száma hüvelykenként **RO** Numărul de dinți pe centimetru al pânzei de ferăstrău pentru metal **BG** Зъби на инч от метален трион



DE Volt Einheit der elektrischen Spannung EN Volts unit of electric voltage **FR** Volts - unité de tension électrique **ES** Voltios unidad de tensión eléctrica **HR** Volt jedinica električnog napona **HU** Az elektromos feszültség mértékegysége **RO** Voltji unitate de măsură a tensiunii electrice **BG** Волта единица за электрическо напрежение



DE Elektrischer Spannungsbereich EN Electric voltage range **FR** Plage de tension électrique **ES** Rango de tensión eléctrica **HR** Raspon električnog napona **HU** Elektromos feszültségtartomány **RO** Intervalul de tensiune electrică **BG** Обхват на электрическото напрежение



DE Volt - Einheit der elektrischen Spannung Hertz - Einheit der Frequenz EN Volts - unit of electric voltage Hertz - unit of frequency measurement **FR** Volts - unité de tension électrique Hertz - unité de fréquence **ES** Voltios - unidad de tensión eléctrica Hertz - unidad de frecuencia **HR** Volt - Jedinica električnog napona Hertz - Jedinica za frekvenciju **HU** Volt - az elektromos feszültség mértékegysége Hertz - a frekvencia mértékegysége **RO** Voltji - unitate de tensiune electrică Hertz - unitate de frecvență **BG** Волт - единица за электрическо напрежение Hertz - единица за измерване на честота



DE Wechselstrom EN Alternating current **FR** Courant alternatif **ES** Corriente alterna **HR** Naizmjenična struja **HU** Váltakozó áram **RO** Curent alternativ **BG** Променилив ток



DE Leistungseinheit EN Power unit **FR** Unité de puissance **ES** Unidad de potencia **HR** Mjerna jedinica snage **HU** Teljesítményegység **RO** Unitate de putere **BG** Мощна мерца



DE Maßeinheiten für die Länge EN Units of measurement for length **FR** Unités de mesure de la longueur **ES** Unidades de medida de longitud **HR** Mjerna jedinica dužine **HU** A hosszúság mértékegységei **RO** Unități de măsură a lungimii **BG** Мерни единици за дължина



DE Maßeinheiten für die Länge EN Units of measurement for length **FR** Unités de mesure de la longueur **ES** Unidades de medida de longitud **HR** Mjerna jedinica dužine **HU** A hosszúság mértékegységei **RO** Unități de măsură a lungimii **BG** Мерни единици за дължина



DE Haspelantriebsrad EN return drive mechanism **FR** Engrenage d'entraînement de l'enroulement **ES** Engranaje de accionamiento de la bobina **HR** Pogonski zupčanic namotavanja **HU** A feltekercselés áttétele **RO** Angrenaj de acționare a rolei **BG** Завиващо задвижващо зъбно колело



DE Düsendurchmesser der Spritzpistole EN The diameter of the spray gun nozzle **FR** Diamètre de la buse du pistolet de peinture **ES** Diámetro de la boquilla de la pistola **HR** Promjer mlaznice pištolja za lakiranje **HU** A festékpisztoly fúvókájának átmérője **RO** Diametrul duzei pistolului de pulverizare **BG** Диаметърът на дюзата на pistolета за лакиране



DE Drehzahl EN Rotational speed **FR** Vitesse de rotation **ES** Velocidad **HR** Okretna brzina **HU** Fordulatszám **RO** Viteza de rotație **BG** Скорост на въртене



DE Maximale Drehzahl **EN** Maximum rotational speed **FR** Vitesse de rotation max. **ES** Velocidad máxima **HR** Maksimalna okretna brzina **HU** Maximális fordulatszám **RO** Viteza maximă de rotație **BG** Максимална скорост на въртене



DE Watt, Leistungseinheit **EN** Unit of power is Watt **FR** Watts, unité de puissance **ES** Varios, unidad de potencia **HR** Vat, jedinica snage **HU** Watt, teljesítményegység **RO** Watt, unitate de putere **BG** Ват мощна единица



DE Für Kupferkabel bis zu einem Durchmesser von 0,5 mm **EN** For copper cables up to 0.5 mm in diameter **FR** Pour les câbles en cuivre jusqu'à 0,5 mm de diamètre **ES** Para cables de cobre de hasta 0,5 mm de diámetro **HR** Za bakrene kablove promjera do 0,5 mm **HU** Legfeljebb 0,5 mm átmérőjű rézkábelekhöz **RO** Pentru cabluri de cupru cu diametrul de până la 0,5 mm **BG** За медни кабели с диаметър до 0,5 мм



DE Anzahl der Blätter **EN** Quantity of blades **FR** Nombre de lames **ES** Número de cuchillas **HR** Broj oštrica **HU** Pengék száma **RO** Număr de lame **BG** Брой остриета



DE Anzahl der trapezförmigen Klingen **EN** Quantity of trapezoidal blades **FR** Nombre de lames trapézoïdales **ES** Número de hojas trapezoidales **HR** Broj trapezoidnih oštrica **HU** Trapéz pengék száma **RO** Număr de lame trapezoidale **BG** Брой трапецовидни остриета



DE 2 Sägeblätter **EN** 2 straight saw blades **FR** 2 lames de scie **ES** 2 hojas de sierra **HR** 2 lista **HU** 2 fűrészlap **RO** 2 pânze de ferăstrău **BG** 2 режещи листа



DE 2 Klemmen **EN** 2 clamps **FR** 2 pinces **ES** 2 abrazaderas **HR** 2 stege **HU** 2 szorító **RO** 2 cleme **BG** 2 скоби



DE 6 Schneidräder **EN** 6 cutting wheels **FR** 6 roues de coupe **ES** 6 discos de corte **HR** 6 reznih kotačića **HU** 6 vágókorong **RO** 6 roți de tăiere **BG** 6 режещи колала



DE Anzahl der Bits **EN** Quantity of sockets **FR** Nombre d'embouts **ES** Número de anexos **HR** 6 reznih kotačića **HU** Dugókulcsok száma **RO** Numărul de capșe **BG** Брой контакти



DE 4 austauschbare Köpfe **EN** 4 interchangeable heads **FR** 4 têtes amovibles **ES** 4 cabezales intercambiables **HR** 4 izmjenjive glave **HU** 4 cserélhető fej **RO** 4 capete interschimbabile **BG** 4 сменяеми глави



DE 5 austauschbare Köpfe **EN** 5 interchangeable heads **FR** 5 têtes amovibles **ES** 5 cabezales intercambiables **HR** 5 izmjenjivih glava **HU** 5 cserélhető fej **RO** 5 capete interschimbabile **BG** 5 сменяеми глави



DE Nietkopfgrößen **EN** Sizes of the riveter heads **FR** Tailles des têtes de la riveteuse **ES** Tamaños de cabeza de remache **HR** Veličine glava za alat za zakivanje **HU** Szegecselőfej méretek **RO** Dimensiuni capuri de nituire **BG** Размерите на главите на нитовете



DE Kapazität **EN** Capacity **FR** Capacité **ES** Capacidad **HR** Zapremina **HU** Űrtartalom **RO** Capacitate **BG** Капацитет



DE Kapazität **EN** Capacity **FR** Capacité **ES** Capacidad **HR** Zapremina **HU** Űrtartalom **RO** Capacitate **BG** Капацитет



DE Entgratungswerkzeug zum Ausgleichen der Schnittflächen **EN** Deburrer for alignment of cut surface **FR** Ébavureur pour ébavurer la surface de coupe **ES** Dispositivo de desbarbado para el recorte **HR** Strugač za izravnavanje odrezane površine **HU** Levágott felületek kiegyenlítésére szolgáló sorjázó **RO** Dispozitiv de debavurare pentru nivelarea suprafețelor tăiate **BG** Очистител за изравняване на повърхността на рязане



DE 1000 Heftklammern **EN** 1000 staples **FR** 1000 agrafes **ES** 1000 grapas **HR** Uložak za klamericu od 1000 komada **HU** 1000 tűzőkapocs **RO** 1000 de capșe **BG** 1000 скоби



DE Länge ausgedrückt in Millimetern **EN** Length in millimeters **FR** Longueur exprimée en millimètres **ES** Longitud expresada en milímetros **HR** Dužina izražena u milimetrima **HU** Milliméterben kifejezett hosszúság **RO** Lungime exprimată în milimetri **BG** Дължина, изразена в милиметри



DE Messgenauigkeit des Messschiebers **EN** Caliper measuring accuracy **FR** Précision de mesure du pied à coulisse **ES** Precisión de medición del calibrador **HR** Točnost mjerenja šublera **HU** A tolómérő mérési pontossága **RO** Precizia de măsurare a șublerului **BG** Точност на измерване на шублера



DE Messbereich des Messschiebers **EN** Caliper measuring range **FR** Plage de mesure du pied à coulisse **ES** Rango de medición del calibrador **HR** Mjerni raspon šublera **HU** A tolómérő mérési tartománya **RO** Intervalul de măsurare a șublerului **BG** Обхват на измерване на шублера



DE Dicke der Klinge **EN** Blade thickness **FR** Épaisseur de la lame **ES** Espesor de la hoja **HR** Debljina oštrice **HU** Penge vastagság **RO** Grosimea lamei **BG** Дебелина на острието



DE Breite der Klinge **EN** Blade width **FR** Largeur de la lame **ES** Anchura de la hoja **HR** Širina oštrice **HU** Penge szélesség **RO** Lățimea lamei **BG** Ширина на острието



DE Größe der HakenKlinge **EN** Hook blade size **FR** Taille de la lame à crochet **ES** Tamaño de la hoja del gancho **HR** Veličina kukaste oštrice **HU** A kampós penge mérete **RO** Dimensiunea lamei de cârlig **BG** Размер на острието на кука



DE Dicke des Aluminiumrahmens **EN** Thickness of the aluminum frame **FR** Épaisseur du cadre en aluminium **ES** Espesor del marco de aluminio **HR** Debljina aluminijskog okvira **HU** Alumínium keret vastagság **RO** Grosimea cadrului din aluminiu **BG** Дебелината на алуминиевата рамка



DE Dicke des Aluminiumrahmens **EN** Thickness of the aluminum frame **FR** Épaisseur du cadre en aluminium **ES** Espesor del marco de aluminio **HR** Debljina aluminijskog okvira **HU** Alumínium keret vastagság **RO** Grosimea cadrului din aluminiu **BG** Дебелината на алуминиевата рамка



DE Dicke des Bandes **EN** Thickness of the tape **FR** Épaisseur du ruban **ES** Espesor de la correa **HR** Debljina trake **HU** Szalagvastagság **RO** Grosimea benzii **BG** Дебелината на лентата



DE Länge des Sägeblatts für Gipskartonplatten **EN** Length of the plasterboard saw (G-K) **FR** Longueur de la scie pour plaques de plâtre **ES** Longitud de la cuchilla para placas de yeso **HR** Dužina pile za gipskartonske ploče **HU** Gipszkarton fűrészlap hosszúság **RO** Lungimea fierăstrăului pentru plăci de gips-carton **BG** Дължина на триона за гипскартон



DE Länge der Rückensäge **EN** Length of the backsaw **FR** Longueur de la scie à main **ES** Longitud de la hoja de la cresta **HR** Dužina ručne pile za drvo **HU** Japán fűrész hosszúság **RO** Lungimea fierăstrăului drept **BG** Дължина на преден трион



DE Länge der Lochsäge **EN** Length of the holesaw **FR** Longueur de la scie cloche **ES** Longitud de la sierra **HR** Dužina krune za izrezivanje rupa **HU** Lyukfúró penge hosszúság **RO** Lungimea fierăstrăului sabie **BG** Дължината на циркулярен трион



DE Länge der Nietmaschine **EN** Length of the riveter **FR** Longueur de la riveteuse **ES** Longitud de la remachadora **HR** Dužina klijesta za zakivanje **HU** Szegecselő hosszúság **RO** Lungimea sculei de nituire **BG** Дължината на нитачка



DE Länge des Magnethalters **EN** Length of the magnetic holder **FR** Longueur du support magnétique **ES** Longitud del soporte magnético **HR** Dužina magnetne drške **HU** Mágneses tartó hosszúság **RO** Lungimea suportului magnetic **BG** Дължината на магнитния държач



DE Tiefe der magnetischen Schale **EN** Magnetic bowl depth **FR** Profondeur du bol magnétique **ES** Profundidad de la cubeta magnética **HR** Dubina magnetne posude **HU** Mágneses tál mélység **RO** Adâncimea bolului magnetic **BG** Дълбочина на магнитната купа



DE Durchmesser des Spiegels **EN** Mirror diameter **FR** Diamètre du miroir **ES** Diámetro del espejo **HR** Promjer ogledalca **HU** Tükör átmérő **RO** Diametrul oglinzii **BG** Диаметър на огледалото



DE Größe des Spiegels **EN** Mirror size **FR** Taille du miroir **ES** Tamaño del espejo **HR** Veličina ogledalca **HU** Tükör méret **RO** Dimensiunea oglinzii **BG** Размер на огледалото



DE Länge der Schraubendreher Spitze **EN** Screwdriver bit length **FR** Longueur de l'embout du tournevis **ES** Longitud de la hoja **HR** Dužina vrha odvijača **HU** Csavarhúzó vég hosszúság **RO** Lungimea tijei de șurubelniță **BG** Дължина на бита на отвертката



DE Heftklammer-Typ **EN** Type of staple **FR** Type d'agrafe **ES** Tipo de grapa **HR** Vrsta punjenja za klamerice **HU** Tűzőkapocs típus **RO** Tipul de capșă **BG** Вид скоби



DE Breite der Heftklammer **EN** Width of the staple **FR** Largeur de l'agrafe **ES** Ancho de la grapa **HR** Širina punjenja za klamerice **HU** Tűzőkapocs szélesség **RO** Lățimea capșei **BG** Ширина на скоби



DE Länge ausgedrückt in Metern **EN** Length in meters **FR** Longueur exprimée en mètres **ES** Longitud expresada en metros **HR** Dužina izražena u metrima **HU** Hosszúság méterben kifejezve **RO** Lungime exprimată în metri **BG** Дължина, изразена в метри



DE Anzahl ausgedrückt in Stück **EN** Quantity in pieces **FR** Quantité exprimée en unités **ES** Cantidad expresada en unidades **HR** Količina izražena u komadima **HU** Darabban kifejezett mennyiség **RO** Cantitate exprimată în unități **BG** Количество, изразено в парчета



DE Länge ausgedrückt in Zoll **EN** Length in inches **FR** Longueur exprimée en pouces **ES** Longitud expresada en pulgadas **HR** Dužina izražena u incima **HU** Hüvelykben kifejezett hosszúság **RO** Lungime exprimată în inci **BG** Дължина в инчове



DE Größe der Bits in Zoll **EN** Socket size in inches **FR** Taille des embouts en pouces **ES** Tamaño de las tomas en pulgadas **HR** Količina nastavka u incima **HU** Az aljzatok mérete hüvelykben **RO** Dimensiunea capetelor în inci **BG** Размер на гнездото в инчове



DE Ratschengröße in Zoll **EN** Ratchet size in inches **FR** Taille du cliquet en pouces **ES** Tamaño de la carraca en pulgadas **HR** Veličina čegrtaljke u incima **HU** A racsni mérete hüvelykben **RO** Dimensiunea cheii cu clichet în inci **BG** Размерът на тресчотката в инчове



DE Ratschengröße in Zoll **EN** Ratchet size in inches **FR** Taille du cliquet en pouces **ES** Tamaño de la carraca en pulgadas **HR** Veličina čegrtaljke u incima **HU** A racsni mérete hüvelykben **RO** Dimensiunea cheii cu clichet în inci **BG** Размерът на тресчотката в инчове





DE Schlüsselgröße in Zoll **EN** Wrench size in inches **FR** Taille de la clé en pouces **ES** Tamaño de la llave en pulgadas **HR** Veličina ključa u incima **HU** Kulcsméret hüvelykben **RO** Dimensiunea cheii în inci **BG** Размер на гаечен ключ в инчове

 **DE** Größe der Bits in Zoll EN Socket size in inches **FR** Taille des embouts en pouces **ES** Tamaño de las tomas en pulgadas **HR** Veličina nastavka u inčima **HU** Az aljzatok mérete hüvelykben **RO** Dimensiunea capetelor în inci **BG** Размер на гнездото в инчове

 **DE** Größe der Bits in Zoll EN Socket size in inches **FR** Taille des embouts en pouces **ES** Tamaño de las tomas en pulgadas **HR** Veličina nastavka u inčima **HU** Az aljzatok mérete hüvelykben **RO** Dimensiunea capetelor în inci **BG** Размер на гнездото в инчове

 **DE** 4 Eckkappen EN 4 corner end caps **FR** 4 capuchons d'angle **ES** 4 tapas de esquina **HR** 4 kutne kapice **HU** 4 saroktartó **RO** 4 carapase de colt **BG** 4 ъглови капачки

 **DE** Adapter für Schraubendreherbits 1_4 Zoll EN Adapter for 1_4 inch screwdriver bits **FR** Adaptateur pour embouts de tournevis 1_4 pouce **ES** Adaptador para puntas de destornillador de 1_4 pulgadas **HR** Adapter za vrhove za odvijač 1_4 inča **HU** Adapter csavarhúzóhegyekhez 1_4 inch **RO** Adaptor pentru biți de șurubelniță de 1_4 inch **BG** Адаптер за битове за отвертка 1_4 инча

 **DE** Bi-Metall-Klingen M2 EN M2 bi-metal blades **FR** Lames bi-métal M2 **ES** Cuchillas bimetalicas M2 **HR** Bimetalne oštrice M2 **HU** M2 bimetal pengék **RO** Lame bimetalice M2 **BG** M2 bimetalni ostričeta

 **DE** Bi-Metall-Klingen M42 EN M42 bi-metal blades **FR** Lames bi-métal M42 **ES** Cuchillas bimetalicas M42 **HR** Bimetalne oštrice M42 **HU** M42 bimetal pengék **RO** Lame bimetalice M42 **BG** M42 bimetalni ostričeta

 **DE** Zum Schneiden von Aluminium EN For cutting aluminum **FR** Pour couper l'aluminium **ES** Para cortar aluminio **HR** Za rezanje aluminija **HU** Alumínium vágáshoz **RO** Pentru tăierea aluminiului **BG** Зарязане на алуминий

 **DE** Zum Schneiden von Stahldrahtgewebe EN For cutting steel mesh **FR** Pour couper les grillages en acier **ES** Para cortar mallas metálicas **HR** Za rezanje čelične mreže **HU** Acélháló vágáshoz **RO** Pentru tăierea plaselor de sârmă de oțel **BG** Зарязане на стоманена мрежа

 **DE** Zum Schneiden von Stahl EN For cutting steel **FR** Pour couper l'acier **ES** Para cortar acero **HR** Za rezanje čelika **HU** Acél vágáshoz **RO** Pentru tăierea oțelului **BG** Зарязане на стомана

 **DE** Zum Schneiden von Kunststoffen EN For cutting plastics **FR** Pour couper les matières plastiques **ES** Para cortar plásticos **HR** Za rezanje sintetičke **HU** Műanyag vágáshoz **RO** Pentru tăierea materialelor plastice **BG** Зарязане на пластмаси

 **DE** Gesamtlänge 140 mm EN Overall length 140 mm **FR** Longueur totale 140 mm **ES** Longitud total 140 mm **HR** Sveukupna dužina 140 mm **HU** Teljes hosszúság 140 mm **RO** Lungime totală 140 mm **BG** Обща дължина 140 mm

 **DE** Länge des Arbeitsteils 140 mm EN Working part length 140 mm **FR** Longueur de la partie utile 140 mm **ES** Longitud de la pieza de trabajo 140 mm **HR** Dužina radnog dijela 140 mm **HU** Munkavégző rész hosszúság 140 mm **RO** Lungimea părții de lucru 140 mm **BG** Дължина на работната част 140 mm

 **DE** Länge des Arbeitsteils 50 mm EN Working part length 50 mm **FR** Longueur de la partie utile 50 mm **ES** Longitud de la pieza de trabajo 50 mm **HR** Dužina radnog dijela 50 mm **HU** Munkavégző rész hosszúság 50 mm **RO** Lungimea părții de lucru 50 mm **BG** Дължина на работната част 50 mm

 **DE** Länge des Bandes 4 m EN Length of tape 4 m **FR** Longueur du ruban 4m **ES** Longitud de la cinta 4 m **HR** Dužina trake 4 m **HU** Szalag hosszúság 4 m **RO** Lungime bandă 4 m **BG** Дължина на лента 4 м

 **DE** Tiefe 45 mm EN Depth 45 mm **FR** Profondeur 45 mm **ES** Profundidad 45 mm **HR** Dubina 45 mm **HU** Mélység 45 mm **RO** Adâncime 45 mm **BG** Дълбочина 45 mm

 **DE** Anzahl der Zyklen 100.000 EN Quantity of cycles 100.000 **FR** Nombre de cycles 100 000 **ES** Número de ciclos 100 000 **HR** Broj ciklusa 100 tis **HU** Ciklusszám 100 ezer **RO** Număr de cicluri 100 mii **BG** Брой цикли 100 000

 **DE** Anzahl der Reihen und Bündel pro Reihe EN Quantity of rows and bundles in a row **FR** Nombre de rangées et de faisceaux par rangée **ES** Número de filas y haces por fila **HR** Broj redaka i snopova u redu **HU** Sorok és kötegek száma soronként **RO** Numărul de rânduri și fascicule pe rând **BG** Брой редове и пакети в ред

 **DE** Anzahl der Zähne pro Zoll EN Teeth per inch **FR** Nombre de dents par pouce **ES** Número de dientes por pulgada **HR** Broj zubi u 1 inču **HU** Fogak száma hüvelykenként **RO** Numărul de dinți pe 1 inch **BG** Брой зъби на 1 инч

 **DE** Quadratische Spitze 5 mm EN 5 mm square bit **FR** Embout carré 5 mm **ES** 5 mm extremo cuadrado **HR** Kvadratni vrh 5 mm **HU** Négyszögletes vég 5 mm **RO** Bit pătrat 5 mm **BG** Квадратен връх 5 mm

 **DE** Quadratische Spitze 8 mm EN 8 mm square bit **FR** Embout carré 8 mm **ES** Extremo cuadrado 8 mm **HR** Kvadratni vrh 8 mm **HU** Négyszögletes vég 8 mm **RO** Bit pătrat 8 mm **BG** Квадратен връх 8 mm

 **DE** Quadratische Spitze konisch 6, 7, 8, 9 mm EN Conical square bit 6, 7, 8, 9 mm **FR** Embout conique carré 6, 7, 8, 9 mm **ES** Extremo cuadrado cónico 6, 7, 8, 9 mm **HR** Kvadratni konusni vrh 6, 7, 8, 9 mm **HU** Négyszögletes kúpós vég 6, 7, 8, 9 mm **RO** Bit pătrat conic 6, 7, 8, 9 mm **BG** Конусен квадратен връх 6, 7, 8, 9 mm

 **DE** Dreieckige Spitze 10 mm EN 10 mm triangular bit **FR** Extrémité triangulaire 10 mm **ES** Extremo triangular 10 mm **HR** Trokutni vrh 10 mm **HU** Háromszögletű vég 10 mm **RO** Bit triunghiular 10 mm **BG** 10 mm триъгълен връх

 **DE** Zweiseitige Schraubendreher Spitze 6 mm PH2 EN Reversible screwdriver bit 6 mm PH2 **FR** Embout de tournevis réversible 6 mm PH2 **ES** Punta de destornillador de doble punta de 6 mm PH2 **HR** Dvostrani bit za odvijač 6 mm PH2 **HU** Megfordítható csavarhúzó bifej 6 mm PH2 **RO** Bit dublu de șurubelniță 6 mm PH2 **BG** Двустраничен бит за отверка 6 mm PH2

 **DE** Zweiseitige Schraubendreher Spitze 7 mm PH2 EN Reversible screwdriver bit 7 mm PH2 **FR** Embout de tournevis réversible 7 mm PH2 **ES** Punta de destornillador de doble punta de 7 mm PH2 **HR** Dvostrani bit za odvijač 7 mm PH2 **HU** Megfordítható csavarhúzóhegy 7 mm PH2 **RO** Bit dublu de șurubelniță 7 mm PH2 **BG** Двустраничен бит за отверка 7 mm PH2

 **DE** Spatelspitze 9 mm EN 9 mm spade bit **FR** Embout à bêche 9 mm **ES** Punta de pala 9 mm **HR** Lopatasti vrh 9 mm **HU** 9 mm-es pengehegy **RO** Bit spatulă 9 mm **BG** 9 mm връх на острието

 **DE** Konische Spitzen EN Conical bits **FR** Embouts coniques **ES** Puntas cónicas **HR** Konusni vrhovi **HU** Kúpós végek **RO** Biți conici **BG** Конусни връхчета

 **DE** Feilenform - quadratisch EN File shape - square **FR** Forme de la lime - carré **ES** Forma del expediente cuadrado **HR** Oblik turpije - kvadratni **HU** A reszelő formája - négyzet alakú **RO** Forma pilei - pătrată **BG** Форма на пила - квадрат

 **DE** Feilenform - rund EN File shape - round **FR** Forme de la lime - ronde **ES** Forma de la lima - redonda **HR** Oblik turpije - okrugli **HU** A reszelő formája - kerek **RO** Forma pilei - rotundă **BG** Форма на пила - кръгла

 **DE** Feilenform - oval EN File shape - oval **FR** Forme de la lime - ovale **ES** Forma de la lima: ovalada **HR** Oblik turpije - ovalni **HU** A reszelő formája - ovális **RO** Forma pilei - ovală **BG** Форма на файл - овална

 **DE** Feilenform - halbrund EN File shape - semicircular **FR** Forme de la lime - demi-ronde **ES** Forma de la lima - media caña **HR** Oblik turpije - polukrugli **HU** A reszelő formája - félköríves **RO** Forma pilei - semitotundă **BG** Форма на пила - полукръгла

 **DE** Feilenform - flach konvergent EN File shape - flat, tapered **FR** Forme de la lime - plate, conique **ES** Forma de la lima: plana, cónica **HR** Oblik turpije - ravan konusni **HU** A reszelő formája - lapos kúpós **RO** Forma pilei - plată, conică **BG** Форма на пила - плоска, заострена

 **DE** Feilenform - flach EN File shape - flat **FR** Forme du dossier - plate **ES** Forma de la lima - plana **HR** Oblik turpije - ravan **HU** A reszelő formája - lapos **RO** Forma pilei - plată **BG** Форма на пила - плоска

 **DE** Feilenform - dreieckig EN File shape - triangular **FR** Forme de la lime - triangulaire **ES** Forma de la lima triangular **HR** Oblik turpije - trokutni **HU** A reszelő formája - háromszög alakú **RO** Forma pilei - triunghiulară **BG** Форма на пила - триъгълна

 **DE** 90° Kupplungswinkel EN Connecting angle 90° **FR** Angle d'accouplement 90° **ES** Ángulo de acoplamiento de 90° **HR** Kut spoja 90° **HU** Csatlakozási szög 90° **RO** Unghi de cuplare 90° **BG** Съвързващ ъгъл 90°

 **DE** Magnetisch EN Magnetic **FR** Magnétique **ES** Magnético **HR** Magnetni **HU** Mágneses **RO** Magnetic **BG** Магнитен

 **DE** Maximale Dicke des geschlittenen Materials EN Maximum thickness of the material to be cut **FR** Épaisseur maximale du matériau coupé **ES** Espesor máximo del material cortado **HR** Maksimalna debljina rezanog materijala **HU** Maximális vágható anyagvastagság **RO** Grosimea maximă a materialului tăiat **BG** Максимална дебелина на материала зарязане

 **DE** Maximaler Spannereich 65 mm EN The maximum clamping range is 65 mm **FR** Plage de serrage maximale 65 mm **ES** Rango máximo de sujeción 65 mm **HR** Maksimalni raspon stezanja 65 mm **HU** Maximális befogási tartomány 65 mm **RO** Intervalul maxim de presare 65 mm **BG** Максималният обхват на затягане е 65 mm

 **DE** Keilbefestigung EN Clamping with a gusset **FR** Fixation avec la cale **ES** Fijación en cuña **HR** Pričvrščenje klinom **HU** Ék rögzítés **RO** Fixare cu pană **BG** Закопчаване с клин

 **DE** Befestigung für Rohre mit max. 28 mm Durchmesser EN Clamping pipes with a maximum diameter of 28 mm **FR** Fixation des tuyaux d'un diamètre maximal de 28 mm **ES** Montaje de tubos con un diámetro máximo de 28 mm **HR** Pričvrščenje cijevi max promjera 28 mm **HU** Legfeljebb 28 mm átmérőjű csövek rögzítése **RO** Fixare pentru țevi cu diametrul maxim de 28 mm **BG** Затягащи тръби с максимален диаметър 28 mm

 **DE** Beil mit profiliertem Keil EN Head with a profiled gusset **FR** Tête avec cale profilée **ES** Cabeza puntiaguada con cuña perfilada **HR** Glava s profiliranim klinom **HU** Hegyes orr profilozott ékkel **RO** Vârf ascuțit cu pană profilată **BG** Форма с профилирен клин

 **DE** Schneiden in einem Winkel von 135° EN Trimming at an angle of 135° **FR** Coupe à un angle de 135° **ES** Corte a 135° **HR** Podrezivanje pod kutom 135° **HU** 135°-os szögben történő vágás **RO** Tăiere la un unghi de 135° **BG** Подрязане под ъгъл 135°

 **DE** Schneiden in einem Winkel von 45° EN Trimming at an angle of 45° **FR** Coupe à un angle de 45° **ES** Corte a 45° **HR** Podrezivanje pod kutom 45° **HU** Vágás 45°-ban **RO** Tăiere la un unghi de 45° **BG** Подрязане под ъгъл 45°



DE Schneiden in einem Winkel von 90° **EN** Trimming at an angle of 90° **FR** Coupe à un angle de 90° **ES** Corte a 90° **HR** Podrezi-vanje pod kutom 90° **HU** 90°-os vágás **RO** Taierea la unghi de 90° **BG** Подрязване под ъгъл 90°



DE Sägeblattverstellung von 45° und 90° **EN** Blade adjustment at an angle of 45° and 90° **FR** Réglage de la lame à 45° et 90° **ES** Ajuste de la hoja a 45° y 90° **HR** Podešavanje lista za pilu pod kutom 45° i 90° **HU** 45° és 90° fokos penge beállítás **RO** Reglarea pânzei la 45° și 90° **BG** Регулиране на острието под ъгъл 45° и 90°



DE Typ der auswechselbaren Sägeblätter **EN** Type of replaceable blades **FR** Type de lames amovibles **ES** Tipo de cuchillas intercambiables **HR** Vrste izmjenjivih listova **HU** Cserélhető pengék típusa **RO** Tipul pânzelor interschimbabile **BG** Тип сменяеми остриета



DE Rückholfeder **EN** Return spring **FR** Ressort de rappel **ES** Muelle de retorno **HR** Povratna opruga **HU** Visszatérő rugó **RO** Arc de întoarcere **BG** Обратна пружина



DE Stabile Stahlfeder **EN** Steel, durable spring **FR** Ressort en acier robuste **ES** Acero, muelle fuerte **HR** Čelična, izdržljiva opruga **HU** Tartós acélrugó **RO** Arc robust din oțel **BG** Стомана, издръжлива пружина



DE Breite 275 mm **EN** Width 275 mm **FR** 275 mm de large **ES** Ancho 275 mm **HR** Širina 275 mm **HU** Szélesség 275 mm **RO** Lățime 275 mm **BG** Ширина 275 mm



DE Backenbreite 75 mm **EN** Jaw width 75 mm **FR** Largeur de la mâchoire 75 mm **ES** Ancho de mandíbula 75 mm **HR** Širina čeljusti 75 mm **HU** Pofa szélesség 75 mm **RO** Lățimea făcii 75 mm **BG** Ширина на стъга 75 mm



DE Härte der Spitze 55-60 HRC **EN** Bit hardness 55-60 HRC **FR** Dureté de l'embout 55-60 HRC **ES** Dureza de la punta 55-60 HRC **HR** Tvrdća nastavka 55-60 HRC **HU** Hegyekeménység 55-60 HRC **RO** Durețatea vârfului 55-60 HRC **BG** Твърдост на върха 55-60 HRC



DE Härte 44-46 HRC **EN** Blade hardness 44-46 HRC **FR** Dureté de la lame 44-46 HRC **ES** Dureza de la hoja 44-46 HRC **HR** Tvrdća oštrice 44-46 HRC **HU** Penge keménység 44-46 HRC **RO** Duritatea lamei 44-46 HRC **BG** Твърдост на острието 44-46 HRC



DE Zahntyp 2 (mittel) **EN** Tooth type 2 (medium) **FR** Type de denture 2 (moyenne) **ES** Diente tipo 2 (medio) **HR** Tip nazubljena 2 (srednje) **HU** 2-es típusú fog (közepes) **RO** Tip dințe 2 (mediu) **BG** Зъб тип 2 (среден)



DE Füllung mit Stahlkugeln **EN** Filling with steel balls **FR** Remplissage avec des billes d'acier **ES** Relleno con bolas de acero **HR** Ispunjeno čeličnim kuglicama **HU** Acélgolyó töltet **RO** Umplere cu bile de oțel **BG** Пълнене със стоманени топки



DE 10 mm Tischkantenverstellzahnrad **EN** 10 mm table edge adjustment tab **FR** Cannelure de réglage du bord de la table de 10 mm **ES** Estriado para el ajuste del borde de la mesa 10 mm **HR** Potpora za postavljanje ruba stola 10 mm **HU** Kinyúlás az asztal széleének beállításához 10 mm **RO** Canelură de reglare a marginii mesei 10 mm **BG** 10 mm разделя за регулиране на ръба на масата



DE Hohe Klingenhärte 58-64 HRC **EN** High blade hardness 58-64 HRC **FR** Dureté élevée de la lame 58-64 HRC **ES** Alta dureza de la hoja 58-64 HRC **HR** Visoka tvrdoća oštrice 58-64 HRC **HU** Nagy pengekeménység 58-64 HRC **RO** Duritate ridicată a lamei 58-64 HRC **BG** Висока твърдост на острието 58-64 HRC



DE Verstärkter sechseckiger Querschnitt **EN** Reinforced hexagonal section **FR** Section hexagonale renforcée **ES** Sección hexagonal reforzada **HR** Ojačani šesterkutni presjek **HU** Megerősített hatszögletű keresztmetszet **RO** Secțiune transversală hexagonală întărită **BG** Подсилена шестоъгълна секция



DE Nadelschläuche **EN** Plastic hoses **FR** Tuyaux en plastique **ES** Mangueras de aguja **HR** Plastična crijeva **HU** Műanyag tömlők **RO** Furtunuri cu ac **BG** Пластмасови маркучи



DE Arbeitsbereich 38 mm; **EN** Working range 38 mm **FR** Plages de travail 38 mm **ES** Rango de trabajo 38 mm **HR** Radni raspon 38 mm **HU** Munkatartomány 38 mm **RO** Interval de lucru 38 mm **BG** Работен диапазон 38 mm



DE Arbeitsbereich 60 mm; **EN** Working range 60 mm **FR** Plages de travail 60 mm **ES** Rango de trabajo 60 mm **HR** Radni raspon 60 mm **HU** Munkatartomány 60 mm **RO** Interval de lucru 60 mm **BG** Работен диапазон 60 mm



DE Durchmesser der Klinge 3 mm **EN** Blade diameter 3 mm **FR** Diamètre de la lame 3 mm **ES** Diámetro de la hoja 3 mm **HR** Promjer oštrice 3 mm **HU** Pengeátmérő 3 mm **RO** Diametru lamei 3 mm **BG** Диаметър на острието 3 mm



DE Durchmesser der Klinge 8 mm **EN** Blade diameter 8 mm **FR** Diamètre de la lame 8 mm **ES** Diámetro de la hoja 8 mm **HR** Promjer oštrice 8 mm **HU** Pengeátmérő 8 mm **RO** Diametru lamei 8 mm **BG** Диаметър на острието 8 mm



DE Zwei Führungsrollen **EN** Two guide rollers **FR** 2 rouleaux de guidage **ES** Dos rodillos guía **HR** Dva vodeća valjka **HU** Két vezetőgörgő **RO** Două role de ghidare **BG** Две водещи ролки



DE Gesamtlänge des Schneiders 240 mm **EN** Total length of the cutter 240 mm **FR** Longueur totale du coupe-fil 240 mm **ES** Longitud total de la cuchilla 240 mm **HR** Ukupna dužina sjekača 240 mm **HU** A vágó teljes hossza 240 mm **RO** Lungimea totală a tăietorului 240 mm **BG** Обща дължина на резачки 240 mm



DE Armlänge 580-760 mm **EN** Arms length 580-760 mm **FR** Longueur des bras 580-760 mm **ES** Longitud del brazo 580-760 mm **HR** Dužina krakova 580-760 mm **HU** Kar hosszúság 580-760 mm **RO** Lungimea brațelor 580-760 mm **BG** Дължина на раменета 580-760 mm



DE Propan-Butan-Gas **EN** Propane-butane gas **FR** Gaz propane-butane **ES** Gas propano-butano **HR** Plin propan butan **HU** Propán-bután gáz **RO** Gaz propan-butan **BG** Пропан-бутан газ



DE Entgrater **EN** Deburrer **FR** Ébavureur **ES** Gratificante **HR** Strugač **HU** Sorjázó **RO** Debavurator **BG** Дебурер



DE Gewinde G1 F **EN** Thread G1 F **FR** Filet G1 F **ES** Rosca G1 F **HR** Navoj G1 F **HU** G1 F menet **RO** Filet G1 F **BG** Резба G1 F



DE Gewinde G1 M **EN** Thread G1 M **FR** Filet G1 M **ES** Rosca G1 M **HR** Navoj G1 M **HU** G1 M menet **RO** Fir G1 M **BG** G1 M резба



DE Gewinde G7 16 Zoll **EN** Thread G7 16 inch **FR** Filet G7 16 pouces **ES** Rosca G7 16 pulgadas **HR** Navoj G7 16 inča **M** **HU** G7 16 hüvelykes M menet **RO** Filet G7 16 inch **M** **BG** G7_16 инчов M резба



DE Zusätzlich induktionsgehärteter Kopf **EN** The head is additionally induction hardened **FR** Tête supplémentaire durcie par induction **ES** Cabeza endurecida adicionalmente por inducción **HR** Glava dodatno induktivno kaljena **HU** Induktívan ismételtlen edezett fej **RO** Cap suplimentar călit prin inducție **BG** Главата е допълнително закалена с индукция



DE V-Form der Klinge **EN** Blade shape **V** **FR** Forme de la lame **V** **ES** Forma de la hoja **V** **HR** Oblik oštrice **V** **HU** Penge alak **V** **RO** Forma lamei **V** **BG** Форма на острието **V**



DE Material Gusseisen **EN** Cast iron material **FR** Matériau fonte **ES** Material hierro fundido **HR** Materijal lijevano željezo **HU** Öntöttvas anyag **RO** Material fontă **BG** Чугунен материал



DE TH-Matrix **EN** TH type matrix **FR** Matrice de type TH **ES** Matriz tipo TH **HR** Matrica tip TH **HU** TH típusú matrica **RO** Matrice TH **BG** Матрица тип TH



DE U-Matrix **EN** U type matrix **FR** Matrice de type U **ES** Matriz tipo U **HR** Matrica tip U **HU** U-típusú matrica **RO** Matrice de tip U **BG** U-тип матрица



DE Maximaler Rohrdurchmesser 110 mm **EN** Max diameter of pipes 110 mm **FR** Diamètre maximal des tuyaux 110 mm **ES** Diámetro máximo del tubo 110 mm **HR** Max promjer cijevi 110 mm **HU** Max csőátmérő 110 mm **RO** Diametru maxim al țevilor 110 mm **BG** Максимален диаметър на тръбите 110 mm



DE Maximaler Rohrdurchmesser 35 mm **EN** Max diameter of pipes 35 mm **FR** Diamètre maximal des tuyaux 35 mm **ES** Diámetro máximo del tubo 35 mm **HR** Max promjer cijevi 35 mm **HU** Max csőátmérő 35 mm **RO** Diametru maxim al țevilor 35 mm **BG** Максимален диаметър на тръбите 35 mm



DE Kartusche 190 g **EN** Nabój 190g **FR** Cartouche 190g **ES** Cartucho 190g **HR** Patrona 190g **HU** Patron 190g **RO** Cartuș 190g **BG** Касета 190g



DE HSS-Klingendurchmesser 35 mm **EN** HSS blade diameter 35 mm **FR** Lame HSS diamètre 35 mm **ES** Diámetro de la hoja HSS 35 mm **HR** Oštrica s HSS promjera 35 mm **HU** HSS penge átmérő 35 mm **RO** Diametru lamei HSS 35 mm **BG** Диаметър на острието HSS 35 mm



DE Metrische Skala **EN** Metric graduation **FR** Échelle métrique **ES** Escala métrica **HR** Metričko mjerilo **HU** Metrikus skála **RO** Scară metrică **BG** Метричен мащаб



DE Taste AUTO START_STOP **EN** AUTO START_STOP button **FR** Touche AUTO START_STOP **ES** Botón AUTO START_STOP **HR** Tipka AUTO START_STOP **HU** AUTO START_STOP gomb **RO** Buton AUTO START_STOP **BG** AUTO START_STOP бутон



DE TWIST-Anschluss **EN** TWIST connection type **FR** Raccordement TWIST **ES** Conexión tipo TWIST **HR** Priključak tipa TWIST **HU** TWIST típusú csatlakozás **RO** Conexiune de tip TWIST **BG** TWIST връзка



DE Kontrolle der Flamme **EN** Flame regulation **FR** Réglage de la flamme **ES** Control de la llama **HR** Regulacija plamena **HU** Lángvezérlés **RO** Controlul flăcării **BG** Регулиране на пламяка



DE S-förmige Backen **EN** S-shaped jaws **FR** Mâchoire en forme de S **ES** Mandíbulas en forma de S **HR** Čeljusti u obliku slova S **HU** S alakú pófák **RO** Fălci în formă de S **BG** S-образни челюсти



DE Gasart - MAPP **EN** Gas type - MAPP **FR** Type de gaz - MAPP **ES** Tipo de gas - MAPP **HR** Tip plina - MAPP **HU** Gáztípus - MAPP **RO** Tipul de gaz - MAPP **BG** Тип газ - MAPP



DE Arbeitsbereich 1/2 Zoll-2 Zoll **EN** Working range 1/2 inch-2 inch **FR** Plage de travail 1/2 pouce-2 pouces **ES** Rango de trabajo 1/2 pulgada-2 pulgadas **HR** Radni raspon 1/2 inča - 2 inča **HU** Munkatartomány 1/2 hüvelyk - 2 hüvelyk **RO** Intervalul de lucru 1/2 inch - 2 inch **BG** Работен диапазон 1_2 инча-2 инча



DE Arbeitsbereich 20 - 60 mm **EN** Working range 20-60 mm
FR Plages de travail 20 - 60 mm **ES** Rango de trabajo 20-60 mm
HR Radni raspon 20-60 mm **HU** Munkatartomány 20 - 60 mm
RO Intervalul de lucru 20-60 mm **BG** Работен диапазон 20-60 мм



DE Ersatz Klinge **EN** Spare blade **FR** Lame de rechange **ES** Cuchilla de recambio **HR** Rezervne oštrice **HU** Tartalék penge
RO Lamă de rezervă **BG** Резервно острие



DE Gasverbrauch 123 g/h **EN** Gas consumption 123 g/h **FR** Consommation de gaz 123 g/h **ES** Consumo de gas 123 g/h **HR** Potrošnja plina 123 g/h **HU** Gázfogyasztás 123 g/h **RO** Consumul de gaz 123 g/h **BG** Разход на газ 123 g/h



DE Luftverbrauch 113 l/min **EN** Air consumption 113 l/min **FR** Consommation d'air 113 l/min **ES** Consumo de aire 113 l/min **HR** Potrošnja zraka 113 l/min **HU** Levegőfogyasztás 113 l/min **RO** Consumul de aer 113 l/min **BG** Консумация на въздух 113 л_мин



DE Luftverbrauch 142 l/min **EN** Air consumption 142 l/min **FR** Consommation d'air 142 l/min **ES** Consumo de aire 142 l/min **HR** Potrošnja zraka 142 l/min **HU** Levegőfogyasztás 142 l/min **RO** Consumul de aer 142 l/min **BG** Консумация на въздух 142 л_мин



DE Li-Ion 600 mA Batterie **EN** Li-Ion 600 mA battery **FR** Batterie Li-Ion 600 mA **ES** Batería de iones de litio 600 mA **HR** Baterija Li-Ion 600 mA **HU** 600 mA Li-Ion elem **RO** Baterie Li-Ion de 600 mA **BG** Li-Ion 600 mA батерия



DE Li-Ion 900 mA Batterie **EN** Li-Ion 900 mA battery **FR** Batterie Li-Ion 900 mA **ES** Batería de iones de litio de 900 mA **HR** Baterija Li-Ion 900 mA **HU** Li-Ion 900 mA elem **RO** Baterie Li-Ion de 900 mA **BG** Литиево-йонна батерия 900 mA



DE I. Gang der Temperaturregelung 250 l/min 50-450°C **EN** Stage I of temperature regulation 250 l/min 50-450°C **FR** Vitesse I du régulateur de température 250 l/min 50-450°C **ES** Control de la temperatura de funcionamiento I 250 l/min 50-450°C **HR** Brzina I regulacije temperature 250 l/min 50-450°C **HU** Hőmérséklet-szabályozó I fokozat 250 l/min 50-450°C **RO** Treapta I de reglare a temperaturii 250 l/min 50-450°C **BG** Етан I на температурен контрол 250 l/min 50-450 ° C



DE I. Gang der Temperaturregelung 300 l/min 350°C **EN** Stage I of temperature regulation 300 l/min 350 ° C **FR** Vitesse I du régulateur de température 300 l/min 350°C **ES** Control de la temperatura de funcionamiento I 300 l/min 350°C **HR** Brzina I regulacije temperature 300 l/min 350°C **HU** Hőmérséklet-szabályozó I fokozat 300 l/min 350 ° C **RO** Treapta I de reglare a temperaturii 300 l/min 350°C **BG** Етан I на температурен контрол 300 l/min 350 ° C



DE II. Gang der Temperaturregelung 500 l/min 60-600°C **EN** Stage II of temperature regulation 500 l/min 60-600 ° C **FR** Vitesse II du régulateur de température 500 l/min 60-600°C **ES** Run II control de temperatura 500 l/min 60-600°C **HR** Brzina II regulacije temperature 500 l/min 60-600°C **HU** Hőmérséklet-szabályozó II fokozat 500 l/min 60-600°C **RO** Treapta II de reglare a temperaturii 500 l/min 60-600°C **BG** Етан II на температурен контрол 500 l/min 60-600 ° C



DE II. Gang der Temperaturregelung 500 l/min 600°C **EN** Stage II of temperature regulation 500 l/min 600 ° C **FR** Vitesse II du régulateur de température 500 l/min 600°C **ES** Run II control de temperatura 500 l/min 600°C **HR** Brzina II regulacije temperature 500 l/min 600°C **HU** Hőmérséklet-szabályozó II fokozat 500 l/min 600 ° C **RO** Treapta II de reglare a temperaturii 500 l/min 600°C **BG** Етан II на температурен контрол 500 l/min 600 ° C



DE II. Gang der Temperaturregelung 550 l/min 100-600 ° C **EN** Stage II of temperature regulation 550 l/min 100-600 ° C **FR** Vitesse II du régulateur de température 550 l/min 100-600°C **ES** Run II control de temperatura 550 l/min 100-600°C **HR** Brzina II regulacije temperature 550 l/min 100-600°C **HU** Hőmérséklet-szabályozó II fokozat 550 l/min 100-600 ° C **RO** Treapta II de reglare a temperaturii 550 l/min 100-600°C **BG** Етан II на температурен контрол 550 l/min 100-600 ° C



DE Kühlung bei 50°C und 280 l/min **EN** Cooling at 50°C temperature and 280 l/min **FR** Refroidissement à 50°C et 280 l/min **ES** Enfriamiento a 50°C y 280 l/min **HR** Hladjenje na temperaturi 50°C i broju okretaja 280 l/min **HU** Hűtés 50°C-on és 280 l/perc fordulatszám alatt **RO** Răcire la temperatura de 50°C și turajii de 280 l/min **BG** Охлаждане при 50 ° C и 280 l/min



DE Ergonomischer Griff **EN** Ergonomic handle **FR** Poignée ergonomique **ES** Asa ergonómica **HR** Ergonomska drška **HU** Ergonómikus fogantyú **RO** Mâner ergonomic **BG** Ергономична дръжка



DE Leistung 13 W **EN** Power 13 W **FR** Puissance 13 W **ES** 13 W de potencia **HR** Snaga 13 W **HU** Teljesítmény 13 W **RO** Putere 13 W **BG** Мощност 13 W.



DE LED-Beleuchtung **EN** LED lighting **FR** Éclairage LED **ES** Iluminación LED **HR** LED rasvjeta **HU** LED világítás **RO** Iluminare LED **BG** LED осветление



DE Getriebe x 5 **EN** x5 stages **FR** Engrenage x 5 **ES** Caja de cambios x 5 **HR** Zupčanik x 5 **HU** Áttétel x 5 **RO** Cutie de viteze x 5 **BG** Предаване x 5



DE Drehzahl 10000-32000 U/min **EN** Rotation speed 10000-32000 rpm **FR** Vitesse 10000-32000 tr_min **ES** Velocidad 10000-32000 rpm **HR** Okretna brzina 10000-32000 okr_min **HU** Fordulatszám 10000-32000 ford_perc **RO** Viteza turajiiilor 10000-32000 rpm **BG** Скорост на въртене 10000-32000 об / мин



DE Wolframcarbidge-Fräser 2 Stück **EN** 2 pcs tungsten carbide cutter **FR** Fraises en carbure de tungstène 2 pcs **ES** Fresas de carburo de tungsteno 2 piezas **HR** Fina dljetja od volframovog karbida 2 kom **HU** Volfrámkarbid húzórudak, 2 db **RO** Freze din carbură de tungsten 2 buc **BG** Фрези за волфрамов карбид 2 бр



DE Mabuchi-Motor **EN** Mabuchi engine **FR** Moteur Mabuchi **ES** Motor Mabuchi **HR** Motor Mabuchi **HU** Mabuchi motor **RO** Motor Mabuchi **BG** Двигател Mabuchi



DE Temperatur max. 600°C **EN** Temperature max 600°C **FR** Température max. 600°C **ES** Temperatura máx. 600°C **HR** Temperatura max 600°C **HU** Hőmérséklet max 600°C **RO** Temperatura maximă 600°C **BG** Максимална температура 600 ° C



DE Elastische Welle **EN** Flexible shaft **FR** Arbre flexible **ES** Eje flexible **HR** Elastični valjak **HU** Rugalmas tengely **RO** Arbore flexibil **BG** Гъвкав вал



DE Stromversorgung 230 V 50 Hz **EN** Power supply 230 V 50 Hz **FR** Alimentation 230 V 50 Hz **ES** Alimentación 230 V 50 Hz **HR** Napajanje 230 V 50 Hz **HU** Tápegység 230 V 50 Hz **RO** Alimentare electrică 230 V 50 Hz **BG** Захранване 230 V 50 Hz



DE Spannungsversorgung 3,6 V **EN** Power supply 3,6 V **FR** Alimentation 3,6 V **ES** 3,6 V fuente de alimentación **HR** Napajanje 3,6 V **HU** Tápegység 3,6 V **RO** Alimentare 3,6 V **BG** Захранване 3,6 V



DE Spannungsversorgung 7,2 V **EN** Power supply 7,2 V **FR** Alimentation 7,2 V **ES** Alimentación 7,2 V **HR** Napajanje 7,2 V **HU** Tápegység 7,2 V **RO** Alimentare 7,2 V **BG** Захранване 7,2 V



DE Durchmesser des Zubehörs 3,2 mm **EN** Accessory diameter 3,2 mm **FR** Diamètre des accessoires de 3,2 mm **ES** Diámetro del accesorio 3,2 mm **HR** Promjer dodatka 3,2 mm **HU** Tartozék átmérő 3,2 mm **RO** Diametru accesoriu 3,2 mm **BG** Диаметър на аксесоара 3,2 мм



DE 4 austauschbare Nietköpfe **EN** 4 interchangeable riveter heads **FR** 4 têtes de rivetage amovibles **ES** 4 cabezas de remache intercambiables **HR** 4 zamjenjive glave alata za zakivanje **HU** 4 cserélhető szegecselőfej **RO** 4 capete de nituire interschimbabile **BG** 4 сменяеми глави на нитове



DE T-Kopf-Nagel **EN** T-shaped nail **FR** Clou à tête en T **ES** Clavo en T **HR** Čavao s glavom tipa T **HU** T-fejű szög **RO** Cui pentru cap de tip T **BG** T-образен пирон



DE Leistung 100 W **EN** Power 100 W **FR** Puissance 100 W **ES** 100 W de potencia **HR** Snaga 100 W **HU** Teljesítmény 100 W **RO** Putere 100 W **BG** 100 W мощност



DE Nietkopfgößen **EN** Sizes of the riveter heads **FR** Tailles des têtes de la riveteuse **ES** Tamaños de cabeza de remache **HR** Veličine glava za alat za zakivanje **HU** Szegecselőfej méretek **RO** Dimensiuni capuri de nituire **BG** Размерите на главите на нитовете



DE Betriebstemperatur des Klebstoffs 120-150 ° C **EN** Working temperature of glue 120-150 ° C **FR** Température de service de la colle 120-150°C **ES** Temperatura de trabajo del adhesivo 120-150°C **HR** Radna temperatura ljepila 120-150°C **HU** A ragasztó munkahőmérséklete 120-150°C **RO** Temperatura de funcționare a adezivului 120-150°C **BG** Работна температура на лепилото 120-150 ° C



DE J-Typ-Klammern **EN** J-type staples **FR** Agrafes de type J **ES** Grapas tipo J **HR** Punjenje za klamerice tipa J **HU** típusú tűzőkapcsok **RO** Capse de tip J **BG** Скоби тип J



DE Französische Steckdose **EN** French type socket **FR** Prise française **ES** Toma de corriente francesa **HR** Utičnica francuskog tipa **HU** Francia típusú aljzat **RO** Priză franceză **BG** Гнездо за френски тип



DE Flache Spitze 3 mm **EN** Flat bit 3 mm **FR** Embout plat 3 mm **ES** Hoja plana de 3 mm **HR** Ravni bit 3 mm **HU** 3 mm-es lapos hegy **RO** Vârf plat 3 mm **BG** 3 мм плоско острие



DE Koaxialkabel TriSet 113-Profi-11 **EN** TriSet 113-Profi-11 coaxial cables **FR** Câbles coaxiaux TriSet 113-Profi-11 **ES** Cables coaxiales TriSet 113-Profi-11 **HR** Koncentrični kablovi TriSet 113-Profi-11 **HU** Koaxiális kábelek TriSet 113-Profi-11 **RO** Cabluri coaxiale TriSet 113-Profi-11 **BG** TriSet 113-Profi-11 коаксиални кабели



DE Maximale Belastung 3600 W **EN** Maximum 3600 W **FR** Charge maximale 3600 W **ES** Carga máxima 3600 W **HR** Maksimalno opterećenje 3600 W **HU** Maximális terhelés 3600 W **RO** Sarcina maximă 3600 W **BG** Максимално натоварване 3600 W



DE Maximale Belastung 4000 W **EN** Maximum 4000 W **FR** Charge maximale 4000 W **ES** Carga máxima 4000 W **HR** Maksimalno opterećenje 4000 W **HU** Maximális terhelés 4000 W **RO** Sarcina maximă 4000 W **BG** 4000 W максимално натоварване



DE Werkstoff Al Cu **EN** Al Cu material **FR** Matériau Al Cu **ES** Material Al Cu **HR** Materijal Al Cu **HU** Al Cu anyag **RO** Material Al Cu **BG** Материал Al Cu



DE Material rostfreier Stahl **EN** Stainless steel material **FR** Matériau : acier inoxydable **ES** Material acero inoxidable **HR** Materijal nehrđajući čelik **HU** Rozsdamentes acél anyag **RO** Material oțel inoxidabil **BG** Материал неръждаема стомана



DE Ratschenmechanismus EN Ratchet mechanism **FR** Mécanisme à cliquet **ES** Mecanismo de trinquete **HR** Mehanizam čegrtaljke **HU** Racsnis mechanizmus **RO** Mecanism cu clichet **BG** Механизъм на тресчотка



DE PTFE-beschichtete Schutzschicht EN PTFE coated shell **FR** Revêtement enduit de PTFE **ES** Revestimiento de PTFE **HR** Površina premazana PTFE-om **HU** PTFE bevonattal ellátott bevonat **RO** Acoperire cu strat de PTFE **BG** Копрч с PTFE покритие



DE Leiterquerschnitt 3 x 1-5 mm² EN Wire cross-section 3 x 1-5 mm² **FR** Section du conducteur 3 x 1-5 mm² **ES** Sección del conductor 3 x 1-5 mm² **HR** Presjek voda 3 x 1-5 mm² **HU** Kábel keresztmetszete 3 x 1-5 mm² **RO** Secțiunea transversală a cablului 3 x 1-5 mm² **BG** Напречно сечение на проводника 3 x 1-5 mm²



DE Leiterquerschnitt 3 x 2-5 mm² EN Wire cross-section 3 x 2-5 mm² **FR** Section du conducteur 3 x 2-5 mm² **ES** Sección del conductor 3 x 2-5 mm² **HR** Presjek voda 3 x 2-5 mm² **HU** Kábel keresztmetszete 3 x 2-5 mm² **RO** Secțiunea transversală a cablului 3 x 2-5 mm² **BG** Напречно сечение на проводника 3 x 2-5 mm²



DE Datenkommunikationskabel 4P 6P 8P EN Telecommunication cables 4P 6P 8P **FR** Câbles de télécommunication 4P 6P 8P **ES** Cables de comunicación de datos 4P 6P 8P **HR** Tele-informatički vodovi 4P 6P 8P **HU** Távfinformációs kábelek 4P 6P 8P **RO** Cabluri de telecomunicații 4P 6P 8P **BG** Телекомуникационни кабели 4P 6P 8P



DE Drahtstärke 0,5 - 5 mm² EN Wire thickness 0,5 - 5 mm² **FR** Fil d'une épaisseur de 0,5 - 5 mm² **ES** Espesor del cable 0,5 - 5 mm² **HR** Vod debljine 0,5 - 5 mm² **HU** Kábelvastagság 0,5 - 5 mm² **RO** Grosimea cablului 0,5 - 5 mm² **BG** Дебелина на телта 0,5 - 5 mm²



DE Drahtstärke 8 - 13 mm² EN Wire thickness 8 - 13 mm² **FR** Fil d'une épaisseur de 8 - 13 mm² **ES** Espesor del cable 8 - 13 mm² **HR** Vod debljine 8 - 13 mm² **HU** Kábelvastagság 8 - 13 mm² **RO** Grosimea cablului 8 - 13 mm² **BG** Дебелина на телта 8 - 13 mm²



DE Kabelisolierung Typ H05RR-F EN Cable insulation type H05RR-F **FR** Type d'isolation du câble H05RR-F **ES** Aislamiento del conductor tipo H05RR-F **HR** Vrsta izolacije voda H05RR-F **HU** H05RR-F típusú kábelizetelés **RO** Tipul de izolație a cablului H05RR-F **BG** Кабелна изолация тип H05RR-F



DE Kabelisolierung Typ H07RN-F EN Cable insulation type H07RN-F **FR** Type d'isolation du câble H07RN-F **ES** Tipo de aislamiento del cable H07RN-F **HR** Vrsta izolacije voda H07RN-F **HU** H07RN-F típusú kábelizetelés **RO** Tipul de izolație a cablului H07RN-F **BG** Кабелна изолация тип H07RN-F



DE Steckertyp RG59 EN Type of the connector RG59 **FR** Type de raccord RG59 **ES** Conector tipo RG59 **HR** Vrsta spojnice RG59 **HU** RG59 típusú csatlakozó **RO** Tip conector RG59 **BG** Тип конектор RG59



DE Steckertyp RG6 EN Type of the connector RG6 **FR** Type de raccord RG6 **ES** Conector tipo RG6 **HR** Vrsta spojnice RG6 **HU** RG6 típusú csatlakozó **RO** Tip conector RG6 **BG** Тип конектор RG6



DE Steckertyp RJ10 EN Type of the connector RJ10 **FR** Type de raccord RJ10 **ES** Tipo de conector RJ10 **HR** Vrsta spojnice RJ10 **HU** RJ10 típusú csatlakozó **RO** Tip conector RJ10 **BG** Тип конектор RJ10



DE Steckertyp RJ11 EN Type of the connector RJ11 **FR** Type de raccord RJ11 **ES** Tipo de conector RJ11 **HR** Vrsta spojnice RJ11 **HU** RJ11 típusú csatlakozó **RO** Tip conector RJ11 **BG** Тип конектор RJ11



DE Steckertyp RJ12 EN Type of the connector RJ12 **FR** Type de raccord RJ12 **ES** Tipo de conector RJ12 **HR** Vrsta spojnice RJ12 **HU** RJ12 típusú csatlakozó **RO** Tip conector RJ12 **BG** Тип конектор RJ12



DE Steckertyp RJ45 EN Type of the connector RJ45 **FR** Type de raccord RJ45 **ES** Tipo de conector RJ45 **HR** Vrsta spojnice RJ45 **HU** RJ45 típusú csatlakozó **RO** Tip conector RJ45 **BG** Тип конектор RJ45



DE Schneller Austausch der Matrizen EN Quick exchange of dies **FR** Remplacement rapide de la matrice **ES** Sustitución rápida de la matriz **HR** Brza zamjena matrica **HU** Gyors matrica cseré **RO** Înlocuire rapidă a matricei **BG** Бърз обмен на матрици



DE Härte 48-52 HRC EN Hardness 48-52 HRC **FR** Dureté 48-52 HRC **ES** Dureza 48-52 HRC **HR** Tvrdća 48-52 HRC **HU** Keménység 48-52 HRC **RO** Duritate 48-52 HRC; **BG** Твърдост 48-52 HRC



DE Kabelbaum EN Wiring harness **FR** Faisceau de câbles **ES** Mazo de cables **HR** Snop vodova **HU** Vezetékköteg **RO** Fascicul de cabluri **BG** Кабелен издръжливост



DE Durchschlagfestigkeit 0-39 kV/mm EN Dielectric strength 0-39 kV/mm **FR** Rigidité diélectrique 0-39 kV/mm **ES** Rigidez dieléctrica 0-39 kV/mm **HR** Dielektrična čvrstoća 0-39 kV/mm **HU** Dielektromos szilárdság 0-39 kV/mm **RO** Rigiditate dielectrică 0-39 kV/mm **BG** Диелектрична якост 0-39 kV/mm



DE Wechselspannungsbereich 100-500 V EN Measurement AC voltage range 100-500 V **FR** Plage de mesure de la tension alternative 100-500 V **ES** Rango de medición de la tensión alterna 100-500 V **HR** Raspon mjerenja naizmjeničnog napona 100-500 V **HU** AC feszültség mérési tartomány 100-500 V **RO** Domeniul de măsurare a tensiunii AC 100-500 V **BG** Обхват на измерване на променливо напрежение 100-500 V



DE Kabelbereich 20-10 AWG EN Wire range 20-10 AWG **FR** Gamme de câbles 20-10 AWG **ES** Gama de cables 20-10 AWG **HR** Raspon vodova 20-10 AWG **HU** Kábeltartomány 20-10 AWG **RO** Intervalul cablurilor 20-10 AWG **BG** Обхват на проводниците 20-10 AWG



DE Stärkende Verbindung EN Connection increasing strength **FR** Liaison pour augmenter la force **ES** Combinación de refuerzo **HR** Spoj za jačanje snage **HU** Erőfokozó tengelykapcsoló **RO** Conector de mărire a puterii **BG** Присъединяване за увеличаване на силата



DE Durchmesser 3 mm EN Diameter 3 mm **FR** Diamètre 3 mm **ES** Diámetro 3 mm **HR** Promjer 3 mm **HU** Átmérő 3 mm **RO** Diametru 3 mm **BG** Диаметър 3 mm



DE Kabeldurchmesser max. 22 mm EN Max cable diameter 22 mm **FR** Diamètre du câble max 22 mm **ES** Diámetro del cable máx. 22 mm **HR** Promjer kabla max 22 mm **HU** Kábelátmérő max 22 mm **RO** Diametrul cablului máx. 22 mm **BG** Максимален диаметър на кабела 22 mm



DE Kabeldurchmesser max. 26 mm EN Max cable diameter 26 mm **FR** Diamètre du câble max 26 mm **ES** Diámetro del cable máx. 26 mm **HR** Promjer kabla max 26 mm **HU** Kábelátmérő max 26 mm **RO** Diametrul cablului máx. 26 mm **BG** Максимален диаметър на кабела 26 mm



DE 3-stufige Geschwindigkeitsregelung EN 3-stage speed adjusting **FR** Réglage de la vitesse à 3 niveaux **ES** Regulación de la velocidad en 3 etapas **HR** 3-stupnja regulacije okreta **HU** 3 fokozatú fordulatszám beállítás **RO** Control al vitezei în 3 trepte **BG** Трискепен контрол на скоростта



DE Betriebsdruck 90 PSI_6.3 BAR EN Working pressure 90 PSI_6.3 BAR **FR** Pression de service 90 PSI_6.3 BARS **ES** Presión de trabajo 90 PSI_6.3 BAR **HR** Radni tlak 90 PSI_6.3 BAR **HU** Üzemi nyomás 90 PSI_6.3 BAR **RO** Presiune de funcționare 90 PSI_6.3 BAR **BG** Работно налягане 90 PSI_6.3 BAR



DE Länge 75 mm EN Lengths 75 mm **FR** Longueur 75 mm **ES** Longitudes de 75 mm **HR** Dužine 75 mm **HU** Hosszúság 75 mm **RO** Lungime 75 mm **BG** Дължини 75 mm



DE Länge 78 mm EN Lengths 78 mm **FR** Longueur 78 mm **ES** Longitud 78 mm **HR** Dužine 78 mm **HU** Hosszúság 78 mm **RO** Lungime 78 mm **BG** Дължини 78 mm



DE Länge 90 mm EN Lengths 90 mm **FR** Longueur 90 mm **ES** Longitudes de 90 mm **HR** Dužine 90 mm **HU** Hosszúság 90 mm **RO** Lungime 90 mm **BG** Дължини 90 mm



DE Länge des Stahlzapfens 150 mm EN The length of the steel adapter 150 mm **FR** Longueur de l'embout en acier 150 mm **ES** Longitud de la espiga de acero 150 mm **HR** Dužina čeličnog cijevnog priključka 150mm **HU** Acélcsonk hosszúság 150 mm **RO** Lungime filet de oțel 150 mm **BG** Дължината на стоманената тръба 150 mm



DE Schlauchlänge 200 mm EN Hose length 200 mm **FR** Longueur du tuyau 200mm **ES** Longitud de la manguera 200 mm **HR** Dužina crijeva 200 mm **HU** Tomló hosszúság 200 mm **RO** Lungime furtun 200 mm **BG** Дължина на маркуца 200 mm



DE Schlauchlänge 450 mm EN Hose length 450 mm **FR** Longueur du tuyau 450 mm **ES** Longitud de la manguera 450 mm **HR** Dužina crijeva 450 mm **HU** Tomló hosszúság 450 mm **RO** Lungime furtun 450 mm **BG** Дължина на маркуца 450 mm



DE Maximaler Bohrdurchmesser 10 mm EN Maximum drilling diameter 10 mm **FR** Diamètre maximal de perçage 10 mm **ES** Diámetro máximo de perforación 10 mm **HR** Maksimalni promjer bušenja 10 mm **HU** Maximális fúrási átmérő 10 mm **RO** Diametrul maxim de găurire 10 mm **BG** Максимален диаметър на пробиване 10 mm



DE Lufteinlass 142,5 l_min EN Air consumption 142,5 l_min **FR** Admission d'air 142,5 l_min **ES** Entrada de aire 142,5 l_min **HR** Potrošnja zraka 142,5 l_min **HU** Légfogyasztás 142,5 l_min **RO** Admisie de aer 142,5 l_min **BG** Консумация на въздух 142,5 l_min



DE Tankinhalt 25 cm³_15 cm³ EN The capacity of the tanks 25 cm³_15 cm³ **FR** Capacité des réservoirs 25 cm³_15 cm³ **ES** Capacidad del depósito 25 cm³_15 cm³ **HR** Zapremina spremnika 25 cm³_15 cm³ **HU** Tartályok befogadóképessége 25 cm³_15 cm³ **RO** Capacitate rezervoare 25 cm³_15 cm³ **BG** Капацитетът на резервоарите 25 cm³_15 cm³



DE Drehzahlwähler EN Rotation switch **FR** Sélecteur de vitesse **ES** Selector de velocidad **HR** Regulator okretaja **HU** Sebességválasztó kapcsoló **RO** Comutator de viteză **BG** Превключвател за въртене



DE Luftanschluss 1/2" EN 1/2 inch air connection **FR** Entrée d'air 1/2 pouce **ES** Conexión de aire de 1/2 pulgada **HR** Zračni priključak 1/2 inča **HU** Levegőcsatlakozás 1/2 hüvelyk **RO** Conexiune de aer 1/2 inch **BG** 1_2 инчова въздушна връзка



DE Luftanschluss 1/4" EN 1/4 inch air connection **FR** Entrée d'air 1/4 pouce **ES** Conexión de aire 1/4 pulgada **HR** Zračni priključak 1/4 inča **HU** Levegőcsatlakozás 1/4 hüvelyk **RO** Conexiune de aer 1/4 inch **BG** 1_4 инчова въздушна връзка



DE Luftanschluss 3/8" EN 3/8 inch air connection **FR** Entrée d'air 3/8 pouce **ES** Conexión de aire 3/8 pulgada **HR** Zračni priključak 3/8 inča **HU** Levegőcsatlakozás 3/8 hüvelyk **RO** Conexiune de aer 3/8 inch **BG** 3_8 инчова въздушна връзка



DE Drehzahl 10500 U/Min. **EN** Rotation speed 10500 RPM **FR** Vitesse 10500 RPM **ES** Velocidad 10500 RPM **HR** Okretna brzina 10500 RPM **HU** Fordulatszám 10500 RPM **RO** Viteză de rotație 10500 RPM **BG** Скорост на въртене 10500 RPM



DE Adaptergrößen F 1/2 Zoll_x_M 3/4 Zoll **EN** Sizes adapter F 1/2 inch_x_M 3/4 inch **FR** Tailles de l'adaptateur F 1/2 pouce_x_M 3/4 pouce **ES** Tamaños de adaptador F 1/2 pulgadas_x_M 3/4 pulgadas **HR** Dimenzije adaptera F 1/2 inča_x_M 3/4 inča **HU** Adapter méretek F 1/2 hüvelyk_x_M 3/4 hüvelyk **RO** Dimensiuni adaptor F 1/2 inča_x_M 3/4 inča **BG** Размери на адаптера F 1_2 инча_x_M 3_4 инча



DE Adaptergrößen F 3_4 Zoll_x_M 1 Zoll **EN** Sizes adapter F 3_4 inch_x_M 1 inch **FR** Tailles de l'adaptateur F 3_4 pouces_x_M 1 pouce **ES** Medidas del adaptador F 3_4 pulgadas_x_M 1 pulgadas **HR** Dimenzije adaptera F 3_4 inča_x_M 1 cal **HU** Adapter méretek F 3_4 hüvelyk_x_M 1 hüvelyk **RO** Dimensiuni adaptor F 3_4 inča_x_M 1 inča **BG** Размери на адаптера F 3_4 инча_x_M 1 инч



DE 2 Bremsen **EN** 2 brakes **FR** 2 freins **ES** 2 frenos **HR** 2 kočnice **HU** 2 fék **RO** 2 frâne **BG** 2 спирачки



DE 2 gefräste Kanten **EN** 2 milled edges **FR** 2 bords fraisés **ES** 2 bordes fresados **HR** 2 glodana ruba **HU** 2 maratott él **RO** 2 margini frezate **BG** 2 фреззовани ръба



DE Übersichtliches LCD-Display **EN** Clear LCD display **FR** Affichage LCD lisible **ES** Pantalla LCD clara **HR** Pregledan LCD zaslon **HU** Jól olvasható LCD kijelző **RO** Afişaj LCD lizibil **BG** Ясен LCD дисплей



DE Messgenauigkeit ± 2 mm **EN** Doktađnošć pomiaru ± 2 mm **FR** Précision de la mesure ± 2 mm **ES** Precisión de medición ± 2 mm **HR** Točnost mjerenja ± 2 mm **HU** Mérési pontosság ± 2 mm **RO** Precizia de măsurare ± 2 mm **BG** Точност на измерване ± 2 mm



DE Messgenauigkeit ± 0,01 mm **EN** Measurement accuracy ± 0,01 mm **FR** Précision de la mesure ± 0,01 mm **ES** Precisión de medición ± 0,01 mm **HR** Točnost mjerenja ± 0,01 mm **HU** Mérési pontosság ± 0,01 mm **RO** Precizia de măsurare ± 0,01 mm **BG** Точност на измерване ± 0,01 mm



DE Messgenauigkeit ± 0,02 mm **EN** Measurement accuracy ± 0,02 mm **FR** Précision de la mesure ± 0,02 mm **ES** Precisión de medición ± 0,02 mm **HR** Točnost mjerenja ± 0,02 mm **HU** Mérési pontosság ± 0,02 mm **RO** Precizia de măsurare ± 0,02 mm **BG** Точност на измерване ± 0,02 mm



DE Messgenauigkeit ± 0,5 mm pro 1 m **EN** Measurement accuracy ± 0,5 mm at 1m **FR** Précision de mesure ± 0,5 mm na 1m **ES** Precisión de medición ± 0,5 mm por 1m **HR** Točnost mjerenja ± 0,5 mm na 1m **HU** Mérési pontosság ± 0,5 mm 1 méterenként **RO** Precizia de măsurare ± 0,5 mm per 1m **BG** Точност на измерване ± 0,5 mm на 1 м



DE Messgenauigkeit ± 0,5 mm pro 1m_1 **EN** Measurement accuracy ± 0,5 mm at 1m_1 **FR** Précision de mesure ± 0,5 mm na 1m_1 **ES** Precisión de medición ± 0,5 mm por 1m_1 **HR** Točnost mjerenja ± 0,5 mm na 1m_1 **HU** Mérési pontosság ± 0,5 mm 1 méterenként_1 **RO** Precizia de măsurare ± 0,5 mm per 1m_1 **BG** Точност на измерване ± 0,5 mm при 1m_1



DE Messgenauigkeit ± 1 mm pro 1 m **EN** Measurement accuracy ± 1mm at 1 m **FR** Précision de mesure ± 1 mm na 1 m **ES** Precisión de medición ± 1mm por 1 m **HR** Točnost mjerenja ± 1 mm na 1m **HU** Mérési pontosság ± 1 mm 1 méterenként **RO** Precizia de măsurare ± 1 mm per 1m **BG** Точност на измерване ± 1 mm на 1 м



DE Dicke des Profils 3 mm **EN** Thickness of profile 3 mm **FR** Épaisseur du profilé 3 mm **ES** Espesor del perfil 3 mm **HR** Debljina profila 3 mm **HU** Profilvastagság 3 mm **RO** Grosimea profilului 3 mm **BG** Дебелина на профила 3 мм



DE Dicke des Wasserwaagenprofils 1,2 mm **EN** Profile thickness of spirit level 1,2 mm **FR** Épaisseur du profilé du niveau à bulle 1,2 mm **ES** Espesor del perfil del nivel de burbuja 1,2 mm **HR** Debljina profila libele 1,2 mm **HU** Vizmértékprofil vastagság 1,2 mm **RO** Grosimea profilului nivelei cu bulă de aer 1,2 mm **BG** Нивото на нивелира е с дебелина 1,2 мм



DE Dicke des Wasserwaagenprofils 1,3 mm **EN** Profile thickness of spirit level 1,3 mm **FR** Épaisseur du profilé du niveau à bulle 1,3 mm **ES** Espesor del perfil del nivel de burbuja 1,3 mm **HR** Debljina profila libele 1,3 mm **HU** Vizmértékprofil vastagság 1,3 mm **RO** Grosimea profilului nivelei cu bulă de aer 1,3 mm **BG** Профилът на нивелира е с дебелина 1,3 мм



DE Dicke des Bandes 0,11 mm **EN** Tape thickness 0.11 mm **FR** Épaisseur du ruban 0,11mm **ES** Espesor de la cinta 0,11 mm **HR** Debljina trake 0.11 mm **HU** Szalagvastagság 0.11 mm **RO** Grosimea benzii 0,11 mm **BG** Дебелина на лентата 0,11 mm



DE Maßeinheiten m Zoll ft (2) **EN** Units of measurement m inch ft (2) **FR** Unités de mesure m inch ft (2) **ES** Unidades de medida m pulgadas pies (2) **HR** Jedinice mjerenja m inč ft (2) **HU** Mértési mértékegységek m inch ft (2) **RO** Unități de măsură m inch ft (2) **BG** Мерни единици m inch ft (2)



DE Maßeinheiten m Zoll **EN** Units of measurement m inch **FR** Unités de mesure m inch **ES** Unidades de medida m pulgadas **HR** Jedinice mjerenja m inč **HU** Mértési mértékegységek m inch **RO** Unități de măsură m inch **BG** Мерни единици m inch ft



DE Maßeinheiten mm Zoll **EN** Units of measurement mm inch **FR** Unités de mesure mm inch **ES** Unidades de medida mm pulgadas **HR** Jedinice mjerenja mm inč **HU** Mértési mértékegységek mm inch **RO** Unități de măsură mm inch **BG** Мерни единици mm инч



DE Isolationsklasse des Messchiebers **EN** Insulation class of the calliper **FR** Catégorie d'isolation du pied à coulisse **ES** Clase de aislamiento del calibrador **HR** Klasa izolacije sublera **HU** A tolmérő szigetelési osztálya **RO** Clasa de izolare a etrierului **BG** Клас на изолация на шублера



DE Selbstverriegelndes Bandmaß **EN** Self-locking measure **FR** Mesure autobloquante **ES** Instrumento de medición con autobloqueo **HR** Metar s auto-blokadom **HU** Önzáró tolmérő **RO** Ruletă de măsură cu autoblocare **BG** Самозаклучваща се мярка



DE Gliedermaßstab mit 10 Segmenten **EN** Measure folding on 10 segments **FR** Mesure pliable 10 segments **ES** Medida de plegado de 10 segmentos **HR** Sklopivi metar 10 segmenta **HU** 10 részes összehajtható mérőlécz **RO** Metru pliant 10 segmente **BG** Ролетка сгваема на 10 сегмента



DE Gliedermaßstab mit 6 Segmenten **EN** Measure folding on 6 segments **FR** Mesure pliable 6 segments **ES** Medida de plegado de 6 segmentos **HR** Sklopivi metar 6 segmenta **HU** 6 részes összehajtható mérőlécz **RO** Metru pliant 6 segmente **BG** Ролетка сгваема на 6 сегмента



DE Stoßfest **EN** Impact resistant **FR** Résistant aux chocs **ES** Resistente a los impactos **HR** Otporan na udarce **HU** Útésálló **RO** Rezistentă la impact **BG** Устойчив на удар



DE Speicher für 30 Messungen **EN** Memory for 30 measurements **FR** Mémoire de 30 mesures **ES** Memoria para 30 mediciones **HR** Memorija 30 mjerenja **HU** 30 mérés memória **RO** Memorie pentru 30 de măsurători **BG** Памет на 30 измервания



DE Messung von Länge, Volumen und Oberfläche **EN** Measurement of volume, length and surface **FR** Mesure de la longueur, du volume et de la surface **ES** Medición de la longitud del volumen y de la superficie **HR** Mjerenje dužine volumena i površine **HU** Térfogat, felület és hosszúság mérése **RO** Măsurarea lungimii volumului și a suprafeței **BG** Измерване на обем и дължина на повърхността



DE Messung unter einem Winkel von 45-90° **EN** Measurement at an angle 45-90° **FR** Mesure à un angle de 45-90° **ES** Medición en un ángulo de 45-90° **HR** Mjerenje pod kutom 45-90° **HU** 45-90°-os szögben történő mérés **RO** Măsurare la un unghi de 45-90° **BG** Измерване под ъгъл 45-90°



DE Messung unter einem Winkel von 90° **EN** Measurement at an angle 0-90° **FR** Mesure à un angle de 90° **ES** Medición en un ángulo de 90° **HR** Mjerenje pod kutom 90° **HU** Mérsés 90°-os szögben **RO** Măsurare la un unghi de 90° **BG** Измерване под ъгъл 90°



DE Füllstandsmessung in einem Winkel von 0-45-90° **EN** Measurement of level at an angle of 0-45-90° **FR** Mesure du niveau à un angle de 0-45-90° **ES** Medición del nivel en un ángulo de 0-45-90° **HR** Mjerenje razine pod kutom 0-45-90° **HU** Szintmérés 0-45-90°-os szögben **RO** Măsurarea nivelului la un unghi de 0-45-90° **BG** Измерване на нивото под ъгъл 0-45-90°



DE Füllstandsmessung in einem Winkel von 0-90° **EN** Measurement of level at an angle of 0-90° **FR** Mesure du niveau à un angle de 0-90° **ES** Medición del nivel en un ángulo de 0-90° **HR** Mjerenje razine pod kutom 0-90° **HU** Szintmérés 0-90°-os szögben **RO** Măsurarea nivelului la un unghi de 0-90° **BG** Измерване на нивото под ъгъл 0-90°



DE Gefräste Seitenkante der Wasserwaage **EN** Milled side edge of the spirit level **FR** Bord latéral fraisé du niveau à bulle **ES** Borde fresado del nivel de burbuja **HR** Glodani bočni rub libele **HU** Hornyolt szintmérő oldalsó él **RO** Margine laterală frezată a nivelei cu bulă de aer **BG** Фрезоз страничен ръб на нивелира



DE Bandspulengetriebe 1-3 **EN** Transmission for winding of tape 1-3 **FR** Engrenage d'enroulement du ruban 1-3 **ES** Engranaje de bobina a bobina 1-3 **HR** Zupčanik za namotavanje trake 1-3 **HU** Szalagsérvelő sebességváltó 1-3 **RO** Angrenaj pentru înfășurare bandă 1-3 **BG** Колан за навиване на колана 1-3



DE Zweiseitige Skala **EN** Two-sided scale **FR** Échelle double face **ES** Balanza de dos caras **HR** Dvostrana ljestvica **HU** Kétoldalas skála **RO** Scară pe două fețe **BG** Двустранична скала



DE Klebeband mit Magneten **EN** Tape with magnets **FR** Ruban avec aimants **ES** Cinta con imanes **HR** Traka s magnetima **HU** Szalag mágnesekkel **RO** Bandă cu magneti **BG** Лента с магнити



DE Gürtelhalter **EN** Handle for belt **FR** Crochet de ceinture **ES** Clip para el cinturón **HR** Kopčica za remen **HU** Övtartó **RO** Suport pentru centură **BG** Щипка за колан



DE Eingebaute Magnete **EN** Built-in magnets **FR** Aimants intégrés **ES** Imanes incorporados **HR** Ugrađeni magneti **HU** Beépített mágnesek **RO** Magnetii încorporați **BG** Вградени магнити



DE Vertikale Ansicht **EN** Vertical view **FR** Vue verticale **ES** Vista vertical **HR** Vertikalni pogled **HU** Függőleges nézet **RO** Vedere verticală **BG** Вертикален изглед



DE Cu-Erkennung bis zu einer Tiefe von 50 mm **EN** Detection of Cu up to a depth of 50 mm **FR** Détection Cu jusqu'à une profondeur de 50 mm **ES** Detección de Cu hasta una profundidad de 50 mm **HR** Detekcija Cu do dubine 50 mm **HU** Cu érzékelés 50 mm mélységig **RO** Detectarea Cu până la o adâncime de 50 mm **BG** Откриване на Cu до дълбочина 50 mm



DE Cu-Erkennung bis zu einer Tiefe von 80 mm **EN** Detection of Cu up to a depth of 80 mm **FR** Détection Cu jusqu'à une profondeur de 80 mm **ES** Detección de Cu hasta una profundidad de 80 mm **HR** Detekcija Cu do dubine 80 mm **HU** Cu érzékelés 80 mm mélységig **RO** Detectarea Cu până la o adâncime de 80 mm **BG** Откриване на Cu до дълбочина 80 mm



DE Holzkerennung bis zu einer Tiefe von 38 mm **EN** Detection of wood up to a depth of 38 mm **FR** Détection du bois jusqu'à une profondeur de 38 mm **ES** Detección de madera hasta una profundidad de 38 mm **HR** Detekcija drveta do dubine 38 mm **HU** Fa érzékelés 38 mm mélységig **RO** Detectarea lemnului până la o adâncime de 38 mm **BG** Откриване на дърво до дълбочина 38 mm



DE Erkennung von Leitungen unter Spannung 50 mm **EN** Detection of live-wires 50 mm **FR** Détection de câbles sous la tension 50 mm **ES** Detección de cables en tensión 50 mm **HR** Detekcija vodova pod naponom 50 mm **HU** Feszültség alatt álló kábelek érzékelése 50 mm **RO** Detectarea cablurilor sub tensiune 50 mm **BG** Откриване на проводници под напрежение 50 mm



DE Berechnung der Maße nach dem Satz des Pythagoras **EN** Calculating of dimension according to the Pythagorean **FR** Calcul de la dimension selon le principe de Pythagore **ES** Cálculo de la dimensión según el principio pitagórico **HR** Izračunavanje dimenzije prema pitagorejskom principu **HU** A méret kiszámítása a Pitagorasz-élv szerint **RO** Calcularea dimensiunii conform principiului lui Pitagora **BG** Изчисляване на измерението според питагорейския принцип



DE Taschenformat **EN** Pocket dimension **FR** Dimension de poche **ES** Dimensión de bolsillo **HR** Džepna veličina **HU** Zsebméret **RO** Dimensiune de buzunar **BG** Джебен размер



DE Stromversorgung über eine CR2032-Batterie **EN** Powered by CR2032 battery **FR** Alimenté par une pile CR2032 **ES** Alimentación Bateria CR2032 **HR** Napajanje baterija CR2032 **HU** CR2032 elemmel működik **RO** Alimentat de o baterie CR2032 **BG** Захранва се от батерия CR2032



DE Erhöhte Aufrollgeschwindigkeit **EN** Increased winding speed **FR** Vitesse d'enroulement accrue **ES** Mayor velocidad de bobinado **HR** Povećana brzina namotavanja **HU** Megnövelt felcsévlési sebesség **RO** Viteză de înfășurare crescută **BG** Повишена скорост на навиване



DE Erhöhte Lebensdauer **EN** Increased endurance **FR** Durabilité accrue **ES** Mayor durabilidad **HR** Povećana čvrstoća **HU** Megnövelt tartósság **RO** Durabilitate crescută **BG** Повишена издръжливост



DE 2 Organizer **EN** 2 organizers **FR** 2 compartiments **ES** 2 organizadores **HR** 2 organizatora **HU** 2 szervező **RO** 2 organizatori **BG** 2 организатора



DE 3 Module **EN** 3 modules **FR** 3 modules **ES** 3 módulos **HR** 3 modula **HU** 3 modul **RO** 3 module **BG** 3 модула



DE 5 Teile **EN** five-piece **FR** 5 parties **ES** 5 partes **HR** 5 -dijelna **HU** 5 részes **RO** 5 părți **BG** 5 части



DE ABS-Taschenlampe **EN** ABS flashlight **FR** Torche ABS **ES** Antorcha ABS **HR** ABS ručna svjetiljka **HU** ABS zseblámpa **RO** Lanternă ABS **BG** Фенерче ABS



DE Einstellbare Trennwände **EN** Adjustable dividers **FR** Compartiments réglables **ES** Separadores ajustables **HR** Podesive pregrade **HU** Állítható elválasztók **RO** Separatoare reglabile **BG** Регулируеми разделители



DE Anzahl der Trennwände 15 **EN** Q-ty of dividers 15 **FR** Nombre de compartiments 15 **ES** Número de compartimentos 15 **HR** Količina pregrada 15 **HU** A rekeszek száma 15 **RO** Număr de partiții 15 **BG** Брой дялове 15



DE Maximales Gewicht 12 kg **EN** Maximum weight 12 kg **FR** Poids maximale 12 kg **ES** Masa máxima 12 kg **HR** Maksimalna težina 12 kg **HU** Maximális súly 12 kg **RO** Greutate maximă 12 kg **BG** Максимално тегло 12 кг



DE Tragfähigkeit des unteren Segments 15 kg **EN** Load capacity of the bottom section 15 kg **FR** Capacité de charge du segment inférieur 15 kg **ES** Capacidad de carga del segmento inferior 15 kg **HR** Nosivost donjeg segmenta 15 kg **HU** Az alsó szegmens teherbírása 15 kg **RO** Capacitatea de încărcare a segmentului inferior 15 kg **BG** Товароносимостта на долната част е 15 кг



DE Tragfähigkeit des oberen Segments 20 kg **EN** Load capacity of the top section 20 kg **FR** Capacité de charge du segment supérieur 20 kg **ES** Capacidad de carga del segmento superior 20 kg **HR** Nosivost gornjeg segmenta 20 kg **HU** A felső szegmens teherbírása 20 kg **RO** Capacitatea de încărcare a segmentului superior 20 kg **BG** Товароносимостта на горния сегмент 20 кг



DE Tragfähigkeit des mittleren Segments 2x5 kg **EN** Load capacity of the middle section is 2x5 kg **FR** Capacité de charge du segment central 2x5 kg **ES** Capacidad de carga del segmento central 2x5 kg **HR** Nosivost srednjeg segmenta 2x5 kg **HU** A középső szegmens teherbírása 2x5 kg **RO** Capacitatea de încărcare a segmentului central 2x5 kg **BG** Товароносимостта на средната част 2x5 кг



DE Einstellbare Trennwände bis zu 20 Stück **EN** Adjustable dividers q-ty up to 20 **FR** Compartiments réglables jusqu'à 20 **ES** Cantidad de divisores ajustables hasta 20 **HR** Podesive pregrade broj do 20 **HU** Akár 20 állítható elválasztó **RO** Compartimente reglabile cu număr de până la 20 **BG** Регулируеми отделения до 20



DE Einstellbare Trennwände bis zu 22 Stück **EN** Adjustable dividers q-ty up to 22 **FR** Compartiments réglables jusqu'à 22 **ES** Separadores ajustables hasta 22 **HR** Podesive pregrade broj do 22 **HU** Akár 22 állítható elválasztó **RO** Compartimente reglabile cu număr de până la 22 **BG** Регулируеми отделения до 22



DE Einstellbare Trennwände bis zu 30 Stück **EN** Adjustable dividers q-ty up to 30 **FR** Compartiments réglables jusqu'à 30 **ES** Separadores ajustables hasta 30 **HR** Podesive pregrade broj do 30 **HU** Akár 30 állítható elválasztó **RO** Compartimente reglabile cu număr de până la 30 **BG** Регулируеми отделения до 30



DE Abnehmbares Tablett **EN** Removable tray **FR** Plateau amovible **ES** Bandeja extraíble **HR** Izmenjiva tacna **HU** Kivehető tálcá **RO** Tavă detașabilă **BG** Подвижна тавă



DE Herausnehmbare Organizer **EN** Removable organizers **FR** Organiseurs amovibles **ES** Organizadores extraíbles **HR** Izmenjivi organizatori **HU** Kivehető szervezők **RO** Organizatoare detașabile **BG** Подвижни организатори



DE Schutzvorrichtung **EN** Safeguards **FR** Protection **ES** Seguridad **HR** Zaštita **HU** Védelem **RO** Protecție **BG** Зашитение



DE 1 Schublade 130 mm **EN** 1 drawer 130 mm **FR** 1 tiroir 130 mm **ES** 1 cajón 130 mm **HR** 1 ladica 130 mm **HU** 1 fiók 130 mm **RO** 1 sertar 130 mm **BG** 1 чекмедже 130 mm



DE 1 Schublade 154 mm **EN** 1 drawer 154 mm **FR** 1 tiroir 154 mm **ES** 1 cajón 154 mm **HR** 1 ladica 154 mm **HU** 1 fiók 154 mm **RO** 1 sertar 154 mm **BG** 1 чекмедже 154 mm



DE 1 Schublade 233 mm **EN** 1 drawer 233 mm **FR** 1 tiroir 233 mm **ES** 1 cajón 233 mm **HR** 1 ladica 233 mm **HU** 1 fiók 233 mm **RO** 1 sertar 233 mm **BG** 1 чекмедже 233 mm



DE 12-eckig **EN** twelve angular **FR** dodécagonal **ES** 12 ángulos **HR** 12-kutni **HU** 12 szögű **RO** 12 unghiuri **BG** 12 -ъглен



DE 2 Lenkrollen mit Feststellern **EN** 2 steering wheels with brakes **FR** 2 roulettes pivotantes avec frein **ES** 2 ruedas giratorias con freno **HR** 2 okretna kotačica s kočnicama **HU** 2 kanyarodó kerék fékkel **RO** 2 roti pivotante cu frâne **BG** 2 колела усуквачи със спирачки



DE 2 Trennwände **EN** 2 dividers **FR** 2 compartiments **ES** 2 tabiques **HR** 2 pregrade **HU** 2 rekesz **RO** 2 compartimente **BG** 2 отделения



DE 2 Schubladen 154 mm **EN** 2 drawers 154 mm **FR** 2 tiroirs 154 mm **ES** 2 Cajones de 154 mm **HR** 2 ladice 154 mm **HU** 2 fiók 154 mm **RO** 2 sertare de 154 mm **BG** 2 чекмеджета 154 mm



DE 4 Räder 5 x 1,25 **EN** 4 wheels 5 x 1,25 **FR** 4 roulettes 5 x 1,25 **ES** 4 ruedas 5 x 1,25 **HR** 4 kotača 5 x 1,25 **HU** 4 kerék 5 x 1,25 **RO** 4 roți 5 x 1,25 **BG** 4 колела 5 x 1,25



DE 4 Schubladen 75 mm **EN** 4 drawers 75 mm **FR** 4 tiroirs 75 mm **ES** 4 cajones 75 mm **HR** 4 kotača 75 mm **HU** 4 fiók 75 mm **RO** 4 sertare de 75 mm **BG** 4 чекмеджета 75 mm



DE 5 Trennwände **EN** 5 dividers **FR** 5 compartiments **ES** 5 compartimentos **HR** 5 pregrada **HU** 5 elválasztó **RO** 5 compartimente **BG** 5 отделения



DE 5 Schubladen 75 mm **EN** 5 drawers 75 mm **FR** 5 tiroirs 75 mm **ES** 5 cajones 75 mm **HR** 5 ladica 75 mm **HU** 5 fiók 75 mm **RO** 5 sertare de 75 mm **BG** 5 чекмеджета 75 mm



DE 6 Trennwände **EN** 6 dividers **FR** 6 compartiments **ES** 6 compartimentos **HR** 6 pregrada **HU** 6 elválasztó **RO** 6 compartimente **BG** 6 отделения



DE 6 Schubladen 50 mm **EN** 6 drawers 50 mm **FR** 6 tiroirs 50 mm **ES** 6 cajones 50 mm **HR** 6 ladica 50 mm **HU** 6 fiók 50 mm **RO** 6 sertare de 50 mm **BG** 6 чекмеджета 50 mm



DE 6 Schubladen 75 mm **EN** 6 drawers 75 mm **FR** 6 tiroirs 75 mm **ES** 6 cajones 75 mm **HR** 6 ladica 75 mm **HU** 6 fiók 75 mm **RO** 6 sertare de 75 mm **BG** 6 чекмеджета 75 mm



DE 72 Zähne **EN** 72 teeth **FR** 72 dents **ES** Púas 72 **HR** 72 zuba **HU** 72 fog **RO** 72 de dinți **BG** 72 зъба



DE Seitliche Türen **EN** Side door **FR** Porte latérale **ES** Puertas laterales **HR** Bočna vrata **HU** Oldalsó ajtó **RO** Uși laterale **BG** Странична врата



DE Dicke 0,6 mm **EN** Thickness 0,6 mm **FR** Épaisseur 0,6 mm **ES** Espesor 0,6 mm **HR** Debljina 0,6 mm **HU** Vastagság 0,6 mm **RO** Grosime 0,6 mm **BG** Дебелина 0,6 mm



DE Dicke 0,8 mm **EN** Thickness 0,8 mm **FR** Épaisseur 0,8 mm **ES** Espesor 0,8 mm **HR** Debljina 0,8 mm **HU** Vastagság 0,8 mm **RO** Grosime 0,8 mm **BG** Дебелина 0,8 mm



DE Dicke 2 mm **EN** Thickness 2 mm **FR** Épaisseur 2 mm **ES** Espesor 2 mm **HR** Debljina 2 mm **HU** Vastagság 2 mm **RO** Grosime 2 mm **BG** Дебелина 2 mm



DE Oberes Staufach **EN** Top cabinet **FR** Compartiment de rangement supérieur **ES** Compartimento superior **HR** Gornje spremište **HU** Felső tárolórekesz **RO** Compartiment de depozitare superior **BG** Горна кутия



DE изоляция до 1000V



DE HEX-Tipp **EN** End cap HEX **FR** Embout HEX **ES** HEX pieza final **HR** HEX nastavak **HU** HEX hegy **RO** Vârf HEX **BG** HEX Накрайник



DE PH-Tipp **EN** End cap PH **FR** Embout PH **ES** Punta PH **HR** PH nastavak **HU** PH hegy **RO** Vârf PH **BG** PH Накрайник



DE PZ-Tipp **EN** End cap **PZ** FR Embout PZ **ES** Punta PZ **HR** PZ nastavak **HU** PZ hegy **RO** Vârf PZ **BG** PZ Накрайник



DE Flache Spitze **SL** **EN** End cap flat **SL** **FR** Embout plat **SL** **ES** Punta plana **SL** **HR** Ravni nastavak **SL** **HU** Lapos **SL** hegy **RO** Vârf plat **BG** Плосък Накрайник **SL**



DE Torx-Spitze **EN** End cap torx **FR** Embout torx **ES** Punta Torx **HR** Torx nastavak **HU** Torx hegy **RO** Vârf Torx **BG** Накрайник Torx



DE PH x PZ Spitzen **EN** End cap PH x PZ **FR** Embout PH x PZ **ES** Puntas PH x PZ bits **HR** Nastavci PH x PZ **HU** PH x PZ hegyek **RO** Vârf PH x PZ **BG** PH x PZ Накрайник



DE winkel 15 Grad **EN** Angle 15 degrees **FR** angle de 15 degrés **ES** ángulo 15 grados **HR** Kut 15 st **HU** 15 fokos szög **RO** unghi de 15 grade **BG** ъгъл 15 градуса



DE Vorhängeschloss **EN** Padlock **FR** Cadenas **ES** Candado **HR** Lokot **HU** Lakat **RO** Lacăt **BG** Катарп



DE Sechskantantrieb HEX 10 mm **EN** 10 mm hexagonal drive **FR** Entraînement hexagonal HEX 10 mm **ES** Accionamiento hexagonal HEX 10 mm **HR** Šesterokutni pogon HEX 10 mm **HU** Hatszögletű szár HEX 10 mm **RO** Dispozitiv de acționare hexagonal HEX 10 mm **BG** HEX 10 mm Шестоъгълно задвижване



DE Sechskantantrieb HEX 1_4 Zoll **EN** 1_4 inch hexagonal drive **FR** Entraînement hexagonal HEX 1_4 pouce **ES** Accionamiento hexagonal HEX 1_4 pulgada **HR** Šesterokutni pogon HEX 1_4 inča **HU** Hatszögletű szár HEX 1_4 hüvelyk **RO** Dispozitiv de acționare hexagonal HEX 1_4 inch **BG** 1_4 инчов Шестоъгълно задвижване



DE Langer Aufsatz **EN** Long cap **FR** Embout long **ES** Toma larga **HR** Dugi nasadni ključ **HU** Hosszú szár **RO** Cap lung **BG** Дълъг накрайник



DE Tragfähigkeit der unteren Schubladen 15 kg **EN** Load capacity of low drawers 15 kg **FR** Capacité de charge des tiroirs bas 15 kg **ES** Capacidad de carga de los cajones bajos 15 kg **HR** Nosivost niskih ladicca 15 kg **HU** Az alacsony fiókok terhelhetősége 15 kg **RO** Capacitatea de încărcare a sertarelor joase 15 kg **BG** Товароносимост на ниски чекмеджета 15 кг



DE Tragfähigkeit der hohen Schubladen 25 kg **EN** Load capacity of high drawers 25 kg **FR** Capacité de charge des tiroirs hauts 25 kg **ES** Capacidad de carga de los cajones de alto nivel 25 kg **HR** Nosivost visokih ladicca 25 kg **HU** A magas fiókok terhelhetősége 25 kg **RO** Capacitatea de încărcare a sertarelor înalte 25 kg **BG** Товароносимост на високи чекмеджета 25 кг



DE Schutz gegen Selbstöffnung **EN** Protection against self-opening **FR** Protection contre l'auto-ouverture **ES** Protección contra la autoapertura **HR** Zaštita od samootvaranja **HU** Önkinnyílás elleni védelem **RO** Protecție împotriva deschiderii automate **BG** Защита срещу самоотваряне



DE Rollenführungen mit Schließmechanismus **EN** Ball bearing guides with closing **FR** Glissières à rouleaux avec mécanisme de fermeture **ES** Corredoras de bolas con cierre **HR** Kuglične vodilice s mekim zatvaranjem **HU** Görgős vezetők behúzással **RO** Ghidaje cu role cu mecanism de închidere **BG** Затварящи се ролкови водачи



DE Rollenführungen **EN** Ball bearing guides **FR** Glissières à rouleaux **ES** Guías de rodillos **HR** Kuglične vodilice **HU** Görgős vezetők **RO** Ghidaje cu role **BG** Ролкови водачи



DE Gelenk **EN** Flexible head **FR** Joint **ES** Bisagra **HR** Zglob **HU** Csukló **RO** Articulație **BG** Сгъва



DE Einstellbare Trennwände **EN** Adjustable dividers **FR** Compartiments réglables **ES** Separadores ajustables **HR** Podesive pre-grade **HU** Allítható elválasztók **RO** Separatoare reglabile **BG** Регулируеми разделители



DE Typ E **EN** Type E **FR** Type E **ES** Tipo E **HR** Tip E **HU** E típus **RO** Tip E **BG** Тип E



DE In Würfel geschnittener Schwammsatz **EN** Sponge insole cut into cubes **FR** Insert éponge coupé en cubes **ES** Esponja cortada en cubos **HR** Spužvasti umetak narezan na kocke **HU** Kockákra vágott szivacsbetét **RO** Inserție de burete tăiată în cuburi **BG** Вложка EVA, нарязана на кубчета



DE EVA-Einlagen **EN** EVA insoles **FR** Semelles en EVA **ES** Plantillas de EVA **HR** EVA umeci **HU** EVA betétek **RO** Inserție EVA **BG** EVA вложка



DE Gefertigt nach der Norm DIN 3110 **EN** Made in accordance with DIN 3110 **FR** Conforme à la norme DIN 3110 **ES** Fabricado según la norma DIN 3110 **HR** Izrađen u skladu sa standardom DIN 3110 **HU** A DIN 3110 norma szerint gyártva **RO** Realizat conform standardului DIN 3110 **BG** Произведено в съответствие с DIN 3110



DE Schubladenschloss **EN** Lock for drawer **FR** Serrure de tiroir **ES** Cerradura de cajón **HR** Brava ladice **HU** Fiókszár **RO** Încuietoarea sertarului **BG** Ключалка за чекмеджета



DE Schloss mit 2 Schlüsseln **EN** Lock with 2 keys **FR** Serrure avec 2 clés **ES** Cerradura con 2 llaves **HR** Brava s 2 ključa **HU** Zár 2 kulccsal **RO** Încuietoare cu 2 chei **BG** Заключалка с 2 ключа



DE 3-Punkt-Scharnier **EN** 3-point hinge **FR** Charnière à 3 points **ES** Bisagra de 3 puntos **HR** Šarke s 3 točke **HU** 3 pontos zsanér **RO** Balama în 3 puncte **BG** 3-точкова панта



DE 4-Punkt-Scharnier **EN** 4-point hinge **FR** Charnière à 4 points **ES** Bisagra de 4 puntos **HR** Šarke s 4 točke **HU** 4 pontos zsanér **RO** Balama în 4 puncte **BG** 4-точкова панта



DE Dekompressionsventil **EN** Decompression valve **FR** Soupape de décompression **ES** Válvula de descompresión **HR** Dekomprisijski ventil **HU** Dekompriziós szelep **RO** Supapă de decompresie **BG** Декомпресионен вентил



DE Leuchtzeit 2,5 h **EN** Lighting time 2.5 hours **FR** Durée d'éclairage 2,5 h **ES** Tiempo de combustión 2,5 h **HR** Vrijeme svijetljenja 2,5 h **HU** Világítási idő 2,5 óra **RO** Timp de iluminare 2,5 h **BG** време реме на осветяване 2,5 часа



DE LED-Beleuchtung 3 W **EN** LED lighting 3 W **FR** Éclairage LED 3 W **ES** Iluminación LED de 3W **HR** LED rasvjeta 3 W **HU** LED világítás 3 W **RO** Iluminare cu LED-uri 3 W **BG** 3 W LED осветление



DE Armabstand 40 mm **EN** Arm spacing 40 mm **FR** Distance entre les bras 40 mm **ES** Distancia del brazo 40 mm **HR** Razmak krakova 40 mm **HU** Karok közötti távolság 40 mm **RO** Distanța dintre brațe 40 mm **BG** Разстояние на раменета 40 мм



DE Halterung für 4 Aufsätze **EN** Handle for 4 caps **FR** Support pour 4 embouts **ES** Soporte para 4 adaptadores **HR** Držac za 4 nasadna ključa **HU** Tartó 4 dugókulcshoz **RO** Suport pentru 4 adaptoare **BG** Поставка за 4 приставки



DE Druckluftschlüssel-Halter **EN** Handle for pneumatic wrench **FR** Support pour la clé pneumatique **ES** Soporte para llaves neumáticas **HR** Držac za pneumatski ključ **HU** Pneumatikus csavarkulcs tartó **RO** Suport pentru cheie pneumatică **BG** Поставка за пневматични ключове



DE Beleuchtungsreichweite 16 m **EN** Lighting range 16 m **FR** Portée de l'éclairage 16 m **ES** Alcance de la iluminación 16 m **HR** Domet svjetla 16 m **HU** Megvilágítási tartomány 16 m **RO** Raza de iluminare 16 m **BG** Обхват на осветление 16 м



DE Beleuchtungsreichweite 18 m **EN** Lighting range 18 m **FR** Portée de l'éclairage 18 m **ES** Alcance de la iluminación 18 m **HR** Domet svjetla 18 m **HU** Megvilágítási tartomány 18 m **RO** Raza de iluminare 18 m **BG** Обхват на осветление 18 м



DE Beleuchtungsreichweite 20 m **EN** Lighting range 20 m **FR** Portée de l'éclairage 20 m **ES** Alcance de la iluminación 20 m **HR** Domet svjetla 20 m **HU** Megvilágítási tartomány 20 m **RO** Raza de iluminare 20 m **BG** Обхват на осветление 20 м



DE Länge 80 mm **EN** Length 80 mm **FR** Longueur 80 mm **ES** Longitud 80 mm **HR** Dužina 80 mm **HU** Hosszúság 80 mm **RO** Lungime 80 mm **BG** Дължина 80 мм



DE Gesamtlänge 10 cm **EN** Total length 10 cm **FR** Longueur totale 10 cm **ES** Longitud total 10 cm **HR** Ukupna duljina 10 cm **HU** Teljes hosszúság 10 cm **RO** Lungime totală 10 cm **BG** Обща дължина 10 см



DE Elastisch **EN** Flexible **FR** Flexible **ES** Flexible **HR** Fleksibilan **HU** Rugalmas **RO** Flexibil **BG** Гъвкав



DE Ratsche 24 Zähne **EN** Ratchet 24 teeth **FR** Cliquet 24 dents **ES** Carraca 24 dientes **HR** Čegrtaljka 24 zuba **HU** 24 fogas racsni **RO** Clichet 24 dinți **BG** Тресчочка с 24 зъба



DE Sehr langer Schlüssel **EN** Wrench very long **FR** Clé très longue **ES** Tecla muy larga **HR** Vrlo dugi ključ **HU** Nagyon hosszú kulcs **RO** Cheie foarte lungă **BG** Много дълъг ключ



DE Langer Schlüssel **EN** Wrench long **FR** Clé longue **ES** Tecla larga **HR** Dugi ključ **HU** Hosszú kulcs **RO** Cheie lungă **BG** Дълъг ключ



DE Kurzer Schlüssel **EN** Wrench short **FR** Clé courte **ES** Llave corta **HR** Kratki ključ **HU** Rövid kulcs **RO** Cheie scurtă **BG** Къс ключ



DE 15° Winkel **EN** 15° angle **FR** angle de 15° **ES** ángulo 15° **HR** kut 15° **HU** 15°-os szög **RO** unghi de 15° **BG** ъгъл 15°



DE 6-Kant-Aufsatz **EN** Hex socket **FR** Douille hexagonale **ES** Toma hexagonal **HR** 6-Kutni nasadni ključ **HU** Hatszögletű dugókulcs **RO** Cap hexagonal **BG** Шестоъгълен накрайник



DE 180-Grad-Drehung **EN** 180 degree rotation **FR** Rotation de 180 degrés **ES** Rotación de 180 grados **HR** Rotacija za 180 stupnjeva **HU** 180 fokos elfordulás **RO** Rotatie de 180 de grade **BG** Въртене на 180 градуса



DE Innerer Absetzring **EN** Inner snap ring **FR** Baquet intérieure **ES** Anillo interior **HR** Unutarnji sigurnosni prsten **HU** Belső rögzítőgyűrű **RO** Inel interior **BG** Въртешен шракващ пръстен



DE Skala in mm **EN** Graduation in mm **FR** Graduation en mm **ES** Paso en mm **HR** Mjerilo u mm **HU** Beosztás mm-ben **RO** Gradatie în mm **BG** Градуиране в мм



DE PTFE-Antihaftbeschichtung **EN** PTFE non-stick coating **FR** Revêtement antiadhésif en PTFE **ES** Revestimiento antiadherente de PTFE **HR** PTFE neprijanjajući premaz **HU** PTFE tapadásmentes bevonat **RO** Înveliș antiaderent PTFE **BG** PTFE незлепящо покритие



DE Gerade EN **Straight** **FR** Droit **ES** Simple **HR** Ravan **HU** Egyenes **RO** Drept **BG** Прав



DE Einstellbare Länge 300x450 mm EN Adjustable length of 300x450 mm **FR** Longueur réglable 300x450 mm **ES** Longitud ajustable 300x450 mm **HR** Podesiva duljina 300x450 mm **HU** Állítható hosszúság 300x450 mm **RO** Lungime reglabilă 300x450 mm **BG** Регулируема дължина 300x450 мм



DE ASS Drive System EN ASS Drive System **FR** Système ASS Drive **ES** Sistema de accionamiento **HR** Sustav ASS Drive **HU** ASS Drive rendszer **RO** Sistem de acționare ASS **BG** Система ASS Drive



DE Selbststellende Backen EN Self-adjusting brake shoes **FR** Mâchoires auto-ajustables **ES** Mordazas autoajustables **HR** Samopodešavajuće celjusti **HU** Önbeállító pófák **RO** Falci cu reglare automată **BG** Саморегулиращи се стяги



DE Härte 58-60 HRC EN Hardness 58-60 HRC **FR** Dureté 58-60 HRC **ES** Dureza 58-60 HRC **HR** Tvrdóća 58-60 HRC **HU** Keménység 58-60 HRC **RO** Duritate 58-60 HRC; **BG** Твърдост 58-60 HRC



DE Verlängerter Griff EN Extended handle **FR** Manche prolongée **ES** Asa extendida **HR** Produžena ručka **HU** Hosszabbított fogantyú **RO** Măner extins **BG** Удължена дръжка



DE Erhöhte Spannkraft EN Increased clamping force **FR** Force de pression accrue **ES** Mayor fuerza de sujeción **HR** Povećana sila pritiska **HU** Megnövelt szorítóerő **RO** Forță de strângere crescută **BG** Повишена сила на затягане



DE Steckertyp RJ 10 EN RJ 10 connector **FR** Type de raccord RJ 10 **ES** Tipo de conector RJ 10 **HR** Konektor RJ 10 **HU** RJ 10 típusú csatlakozó **RO** Conector de tip RJ 10 **BG** RJ 10 конектор



DE Steckertyp RJ11 RJ12 EN RJ11 RJ12 connector **FR** Type de raccord RJ11 RJ12 **ES** Tipo de conector RJ11 RJ12 **HR** RJ11 RJ12 konektor **HU** RJ11 RJ12 típusú csatlakozó **RO** Conector de tip RJ11 RJ12 **BG** RJ11 RJ12 конектор



DE Steckertyp RJ45 EN RJ45 connector **FR** Type de raccord RJ45 **ES** Tipo de conector RJ45 **HR** RJ45 konektor **HU** RJ45 típusú csatlakozó **RO** Conector de tip RJ45 **BG** RJ45 конектор



DE 12 Arten von Clips EN 12 types of clips **FR** 12 types de clips **ES** 12 tipos de clips **HR** 12 vrsta klipova **HU** 12 féle gomb **RO** 12 tipuri de agrafe **BG** 12 вида клипове



DE 18 Arten von Clips EN 18 types of clips **FR** 18 types de clips **ES** 18 tipos de clips **HR** 18 vrsta klipova **HU** 18 féle gomb **RO** 18 tipuri de agrafe **BG** 18 вида клипове



DE 2 Lenkrollen EN 2 swivel wheels **FR** 2 roulettes pivotantes **ES** 2 ruedas giratorias **HR** 2 okretna kotača **HU** 2 kanyarodó kerék **RO** 2 roți pivotante **BG** 2 въртящи се колела



DE 2 feste Rollen EN 2 fixed wheels **FR** 2 roulettes fixes **ES** 2 ruedas fijas **HR** 2 fiksna kotača **HU** 2 fix kerék **RO** 2 roți fixe **BG** 2 фиксирани колела



DE 3 Schraubenlängen 95, 75, 45 mm EN 3 screw lengths 95, 75, 45 mm **FR** 3 longueurs des vis 95, 75, 45 mm **ES** 3 longitudes de tornillo 95, 75, 45 mm **HR** 3 dužine vijka 95, 75, 45 mm **HU** 3 csavarhosszúság 95, 75, 45 mm **RO** 3 lungimi de șuruburi 95, 75, 45 mm **BG** 3 дължини на винта 95, 75, 45 мм



DE 3 Arme mit Aufsätzen 17, 19 und 21 mm EN 3 arms with 17, 19 and 21 mm sockets **FR** 3 bras avec douilles 17, 19 et 21 mm **ES** 3 brazos con toma de 17, 19 y 21 mm **HR** 3 kraka s nastavcima od 17, 19 i 21 mm **HU** 3 kar 17, 19 és 21 mm-es dugókulccsal **RO** 3 brațe cu capuri de 17, 19 și 21 mm **BG** 3 рамена с битове 17, 19 и 21 мм



DE 6 Arten von Clips EN 6 types of clips **FR** 6 types de clips **ES** 6 tipos de clips **HR** 6 vrsta klipova **HU** 6 féle gomb **RO** 6 tipuri de agrafe **BG** 6 вида клипове



DE 6-kant 22mm EN Hex 22mm **FR** hexagonal 22mm **ES** 6-ángulo 22mm **HR** Hex 22 mm **HU** 6-szög 22mm **RO** 6 unghiuri 22mm **BG** Шестостен 22 мм



DE 8 Arten von Clips EN 8 types of clips **FR** 8 types de clips **ES** 8 tipos de clips **HR** 8 vrsta klipova **HU** 8 féle gomb **RO** 8 tipuri de agrafe **BG** 8 вида клипове



DE 9-Stufen-Programm EN 9-step program **FR** Programme à 9 niveaux **ES** Programa de 9 pasos **HR** Program od 9 koraka **HU** 9 fokozatú program **RO** Program în 9 etape **BG** Програма с 9 стъпки



DE Stromstärke 100 A EN 100 A amperage **FR** Ampérage 100 A **ES** Amperaje 100 A **HR** Amperaža 100 A **HU** Áramerősség 100 A **RO** Amperaj 100 A **BG** 100 A ток



DE Stromstärke 2, 8, 15 A EN 2, 8, 15 A amperage **FR** Ampérage 2, 8, 15 A **ES** Amperaje 2, 8, 15 A **HR** Amperaža 2, 8, 15 A **HU** Áramerősség 2, 8, 15 A **RO** Amperaj 2, 8, 15 A **BG** Сила на тока 2, 8, 15 A.



DE Automatische Betriebsmoduswahl EN Automatic operating mode selection **FR** Sélection automatique du mode de fonctionnement **ES** Selección de modo automático **HR** Automatski odabir načina rada **HU** Automatikus üzemmód kiválasztás **RO** Selectarea automată a modului de funcționare **BG** Автоматичен избор на режим на работа



DE Betriebsdruck 1015 PSI EN Working pressure 1015 PSI **FR** Pression de service 1015 PSI **ES** Presión de funcionamiento 1015 PSI **HR** Radni pritisak 1015 PSI **HU** Üzemnyomás 1015 PSI **RO** Presiunea de funcționare 1015 PSI **BG** Работно налягане 1015 PSI



DE Für M14-Buchsen EN For M14 sockets **FR** Pour les douilles M14 **ES** Para tomas M14 **HR** Za utičnice M14 **HU** M14-es aljzatokhoz **RO** Pentru prize M14 **BG** За контакти M14



DE Für M18-Buchsen EN For M18 sockets **FR** Pour les douilles M18 **ES** Para tomas M18 **HR** Za utičnice M18 **HU** M18-as aljzatokhoz **RO** Pentru prize M18 **BG** За контакти M18



DE Für Trommelbremsen EN For drum brakes **FR** Pour les freins à tambour **ES** Para frenos de tambor **HR** Za bubanj kočnice **HU** Dobfékekhez **RO** Pentru frânele cu tambur **BG** За барабани спирачки



DE Für den Einbau und Ausbau von Halogenen EN For assembly and disassembly of halogen lamps **FR** Pour l'installation et le retrait des halogènes **ES** Para montar y desmontar halógenos **HR** Za montažu i demontažu halogena **HU** Halogének beszereléséhez és eltávolításához **RO** Pentru instalarea și îndepărtarea halogenilor **BG** За монтаж и демонтаж на халогени



DE Für den Einbau und Ausbau von Zündkerzen und Leitungen EN For assembly and disassembly of wires and spark plugs **FR** Pour l'installation et le retrait des bougies d'allumage et des câbles **ES** Para el montaje y desmontaje de bujías y cables **HR** Za montažu i demontažu žica i svećica **HU** Gyújtógyertyák és kábelek beszereléséhez és eltávolításához **RO** Pentru instalarea și demontarea bujiilor și a cablurilor **BG** За монтаж и демонтаж на проводници и свещи



DE Für Fahrzeuge der Marken Opel, Rover, VW, Citroen, Ford, Fiat, Peugeot, Isuzu EN For Opel, Rover, VW, Citroen, Ford, Fiat, Peugeot, Isuzu vehicles **FR** Pour les véhicules Opel, Rover, VW, Citroen, Ford, Fiat, Peugeot, Isuzu **ES** Para vehículos de las marcas: Opel, Rover, VW, Citroen, Ford, Fiat, Peugeot, Isuzu **HR** Za vozila Opel, Rover, VW, Citroen, Ford, Fiat, Peugeot, Isuzu **HU** A következő márkájú járművekhez: Opel, Rover, VW, Citroen, Ford, Fiat, Peugeot, Isuzu **RO** Pentru vehicule marca - Opel, Rover, VW, Citroen, Ford, Fiat, Peugeot, Isuzu **BG** За автомобили Opel, Rover, VW, Citroen, Ford, Fiat, Peugeot, Isuzu



DE Für Fahrzeuge VW, BMW, Audi, Ford, Skoda, SEAT EN For VW, BMW, Audi, Ford, Skoda, SEAT vehicles **FR** Pour les véhicules VW, BMW, Audi, Ford, Skoda, SEAT **ES** Para vehículos de las marcas: VW, BMW, Audi, Ford, Skoda, SEAT **HR** Za vozila VW, BMW, Audi, Ford, Skoda, SEAT **HU** A következő márkájú járművekhez: VW, BMW, Audi, Ford, Skoda, SEAT **RO** Pentru vehicule marca - VW, BMW, Audi, Ford, Skoda, SEAT **BG** За автомобили VW, BMW, Audi, Ford, Skoda, SEAT



DE Für Audi-Fahrzeuge EN For Audi vehicles **FR** Pour les véhicules Audi **ES** Para los vehículos Audi **HR** Za vozila Audi **HU** Audi márkájú járművekhez **RO** Pentru vehicule marca Audi **BG** За автомобили на Audi



DE Für BMW-Fahrzeuge EN For BMW vehicles **FR** Pour les véhicules BMW **ES** Para vehículos BMW **HR** Za vozila BMW **HU** BMW márkájú járművekhez **RO** Pentru vehicule marca BMW **BG** За автомобили BMW



DE Für Fiat-Fahrzeuge EN For Fiat vehicles **FR** Pour les véhicules Fiat **ES** Para vehículos Fiat **HR** Za vozila Fiat **HU** Fiat márkájú járművekhez **RO** Pentru vehicule marca Fiat **BG** За автомобили Fiat



DE Für FORD-Fahrzeuge EN For FORD vehicles **FR** Pour les véhicules Ford **ES** Para vehículos FORD **HR** Za vozila FORD **HU** FORD márkájú járművekhez **RO** Pentru vehicule marca FORD **BG** За автомобили FORD



DE Für Honda-Fahrzeuge EN For Honda vehicles **FR** Pour les véhicules Honda **ES** Para vehículos Honda **HR** Za vozila Honda **HU** Honda márkájú járművekhez **RO** Pentru vehicule marca Honda **BG** За автомобили Honda



DE Für Mazda-Fahrzeuge EN For Mazda vehicles **FR** Pour les véhicules Mazda **ES** Para vehículos Mazda **HR** Za vozila Mazda **HU** Mazda márkájú járművekhez **RO** Pentru vehicule marca Mazda **BG** За автомобили Mazda



DE Für Opel-Fahrzeuge EN For Opel vehicles **FR** Pour les véhicules Opel **ES** Para vehículos Opel **HR** Za vozila Opel **HU** Opel márkájú járművekhez **RO** Pentru vehicule marca Opel **BG** За автомобили на Opel



DE Für Peugeot-Fahrzeuge EN For Peugeot vehicles **FR** Pour les véhicules Peugeot **ES** Para los vehículos Peugeot **HR** Za vozila Peugeot **HU** Peugeot márkájú járművekhez **RO** Pentru vehicule marca Peugeot **BG** За автомобили Peugeot



DE Für Renault-Fahrzeuge EN For Renault vehicles **FR** Pour les véhicules Renault **ES** Para los vehículos Renault **HR** Za vozila Renault **HU** Renault márkájú járművekhez **RO** Pentru vehicule marca Renault **BG** За автомобили Renault



DE Für Volkswagen-Fahrzeuge EN For Volkswagen vehicles **FR** Pour les véhicules Volkswagen **ES** Para vehículos Volkswagen **HR** Za vozila Volkswagen **HU** Volkswagen márkájú járművekhez **RO** Pentru vehicule marca Volkswagen **BG** За автомобили Volkswagen



DE Für Volvo und Lexus Fahrzeuge EN For Volvo and Lexus vehicles **FR** Pour les véhicules Volvo et Lexus **ES** Para vehículos Volvo y Lexus **HR** Za vozila Volvo i Lexus **HU** Volvo és Lexus márkájú járművekhez **RO** Pentru vehicule marca Volvo și Lexus **BG** За превозни средства Volvo и Lexus



DE Für Volvo-Fahrzeuge **EN** For Volvo vehicles **FR** Pour les véhicules Volvo **ES** Para vehículos Volvo **HR** Za vozila Volvo **HU** Volvo márkájú járművekhez **RO** Pentru vehicule marca Volvo **BG** За автомобили на Volvo



DE Für VW- und Audi-Fahrzeuge **EN** For VW and Audi vehicles **FR** Pour les véhicules VW et Audi **ES** Para vehículos VW y Audi **HR** Za vozila VW i Audi **HU** VW és Audi márkájú járművekhez **RO** Pentru vehicule marca VW și Audi **BG** За автомобили VW и Audi



DE Für Kupfer- und Aluminiumrohre **EN** For copper and aluminium tubes **FR** Pour les tubes en cuivre et en aluminium **ES** Para tubos de cobre y aluminio **HR** Za bakrene i aluminijске cijevi **HU** Réz- és alumíniumcsövekhez **RO** Pentru țevi de cupru și aluminiu **BG** За медни и алуминиеви тръби



DE Für Motor - BOSCH Einspritzung **EN** For the engine - BOSCH injection **FR** Pour le moteur - injection BOSCH **ES** Al motor - inyección BOSCH **HR** Za motor - BOSCH ubrizgavanje **HU** Motorhoz - BOSCH befecskendezés **RO** Pentru motor - injectie BOSCH **BG** За двигателя - инжектиране BOSCH



DE Für Motor - DELPHI Einspritzung **EN** For the engine - DELPHI injection **FR** Pour le moteur - injection DELPHI **ES** Al motor - inyección DELPHI **HR** Za motor - DELPHI ubrizgavanje **HU** Motorhoz - DELPHI befecskendezés **RO** Pentru motor - injectie DELPHI **BG** За двигателя - инжекция DELPHI



DE Für Motor - DENSO Einspritzung **EN** For the engine - DENSO injection **FR** Pour le moteur - injection DENSO **ES** Al motor - inyección DENSO **HR** Za motor - DENSO ubrizgavanje **HU** Motorhoz - DENSO befecskendezés **RO** Pentru motor - injectie DENSO **BG** За двигателя - инжектиране DENSO



DE Für Motor - SIEMENS Einspritzung **EN** For the engine - SIEMENS injection **FR** Pour le moteur - injection SIEMENS **ES** Al motor - inyección SIEMENS **HR** Za motor - SIEMENS ubrizgavanje **HU** Motorhoz - SIEMENS befecskendezés **RO** Pentru motor - injectie SIEMENS **BG** За двигателя - инжектиране SIEMENS



DE Für DIESEL-Motor **EN** For DISLA engine **FR** Pour le moteur DISLA **ES** Para el motor DISLA **HR** Za DISLA motor **HU** DIESEL motorhoz **RO** Pentru motor DIESEL **BG** За двигателя DISLA



DE Für Sechszylinder-Motor **EN** For the six cylinder engine **FR** Pour le moteur à six cylindres **ES** Para motor de seis cilindros **HR** Za šestocilindrični motor **HU** Hathengeres motorhoz **RO** Pentru motor cu șase cilindri **BG** За шестцилиндровия двигател



DE Für OHV-, OHC- und CHV-Motoren **EN** For OHV, OHC, CHV engines **FR** Pour les moteurs OHV, OHC, CHV **ES** Para motores OHV, OHC, CHV **HR** Za OHV, OHC, CHV motore **HU** OHV, OHC, CHV motorokhoz **RO** Pentru motoare OHV, OHC, CHV **BG** За двигатели OHV, OHC, CHV



DE Für Ventile an Reifen und Schläuchen des Typs Schredder **EN** For Schredder tire valves and tubes **FR** Pour les valves de pneumatiques et de chambres à air de type Schredder **ES** Para válvulas de neumáticos y cámaras de aire del tipo Schredder **HR** Za ventile vanjskih guma i unutarnjih Schredder guma **HU** Schredder típusú gumiabroncsok és belső szelepeikhez **RO** Pentru valvele de la anvelope și camere de aer de tip Schredder **BG** За клапани на гуми и тръби Schredder



DE Für Serviceventile in der Kälte- und Klimatechnik **EN** For service valves in refrigeration and air conditioning **FR** Pour les vannes de service dans la réfrigération et la climatisation **ES** Para válvulas de servicio en refrigeración y aire acondicionado **HR** Za servisne ventile u rashladnim i klima uređajima **HU** Hűtő- és légkondicionáló berendezések szerviszszelepeikhez **RO** Pentru supape de serviciu în refrigerare și aer condiționat **BG** За сервисни клапани в хладилни и климатични инсталации



DE Für Zündkerzen **EN** For spark plugs **FR** Pour les bougies d'allumage **ES** Para las bujías **HR** Za svjećice **HU** Gyújtógyertyákhoz **RO** Pentru buji **BG** За свещи



DE Genauigkeit +/- 2% **EN** Accuracy +/- 2 percent **FR** Précision +/- 2 pour cent **ES** Precisión +/- 2 por ciento **HR** Točnost +/- 2 posto **HU** Pontosság +/- 2 százalék **RO** Precizie +/- 2 procente **BG** Точност +/- 2 процента



DE Einstellung der Genauigkeit 2 Schritte **EN** Setting accuracy 2-step **FR** Réglage de la précision 2 niveaux **ES** Precisión de ajuste 2 grados **HR** Točnost podešavanja 2 stupnja **HU** Pontosság beállítás 2 fokozat **RO** Setarea acurateței 2 pași **BG** Точност на настройка 2 градуса



DE Lange Bits mit Gelenk - 160 mm **EN** Long articulated sockets - 160 mm **FR** Douilles longues avec articulation - 160 mm **ES** Enchufe largo con articulación - 160 mm **HR** Duge zglobne nastavke - 160 mm **HU** Hosszú aljzat csuklóval - 160 mm **RO** Capuri lungi cu articulație - 160 mm **BG** Дълги крайници с фуга - 160 mm



DE Länge 175 mm **EN** Length 175 mm **FR** Longueur 175 mm **ES** Longitud 175 mm **HR** Dužina 175 mm **HU** Hosszúság 175 mm **RO** Lungime 175 mm **BG** Дължина 175 mm



DE Länge des Metallkopfes 150 mm **EN** Metal head length 150 mm **FR** Longueur de la tête métallique 150 mm **ES** Longitud del cabezal metálico 150 mm **HR** Dužina metalne glave 150 mm **HU** A fém fej hossza 150 mm **RO** Lungimea capului metalic 150 mm **BG** Дължината на металната глава е 150 mm



DE Kabellänge 2 m **EN** Total length 2 m **FR** Longueur du câble 2m **ES** Longitud del cable 2 m **HR** Dužina kabla 2 m **HU** Kábel hosszúság 2 m **RO** Lungime cablu 2 m **BG** Дължина на кабела 2 m



DE Elektronische Handbremse **EN** Electronic handbrake **FR** Frein à main électronique **ES** Freno de mano electrónico **HR** Elektonska ručna kočnica **HU** Elektronikus kézifék **RO** Frână de mână electronică **BG** Електронна ръчна спирачка



DE Trapezförmiges Gewinde **EN** Trapezoidal thread **FR** Filet trapezoidal **ES** Rosca trapezoidal **HR** Trapezni navoj **HU** Trapéz menet **RO** Filet trapezoidal **BG** Трапецвидна нишка



DE Anschlussgewinde metrisch M10 x 1 **EN** Metric connecting threads M10 x 1 **FR** Filets de raccordement métriques M10 x 1 **ES** Rosca de conexión métrica M10 x 1 **HR** Metrički spojni navoj M10 x 1 **HU** Csatlakozómenetek metrikus M10 x 1 **RO** Filet de conectare metric M10 x 1 **BG** Метрични рези за свързване M10 x 1



DE Tiefe 43 mm **EN** Depth 43 mm **FR** Profondeur 43 mm **ES** Profundidad 43 mm **HR** Dubina 43 mm **HU** Mélység 43 mm **RO** Adâncime 43 mm **BG** 43 mm дълбочина



DE Aluminium-Kopf **EN** Aluminium head **FR** Tête en aluminium **ES** Cabezal de aluminio **HR** Aluminijaska glava **HU** Alumínium fej **RO** Cap din aluminiu **BG** Алюминиев крайник



DE Kopf aus Zinkdruckguss **EN** Die-cast zinc head **FR** Tête en zinc moulé sous pression **ES** Cabeza de fundición de zinc **HR** Glava od cinkovog odjevka **HU** Öntött cink fej **RO** Cap din zinc turnat sub presiune **BG** Цинков крайник от лее на под налягане



DE Haupt-Spreizbolzen 127 mm **EN** Main expansion bolt 127 mm **FR** Boulon d'écartement principal 127 mm **ES** Perno de separación principal 127 mm **HR** Glavni ekspanzivni vijak 127 mm **HU** Fő szét húzócsavar 127 mm **RO** Șurub principal de expansiune 127 mm **BG** Основен разширителен болт 127 mm



DE Häkchen **EN** Hooks **FR** Crochets **ES** Ganchos **HR** Kuke **HU** Horgok **RO** Cârlige **BG** Куки



DE Anzahl der Arme_8 **EN** Number of arms_2,4 **FR** Nombre de bras_8 **ES** Número de brazos_8 **HR** Broj krakova_8 **HU** Karok száma_8 **RO** Număr de brațe_8 **BG** Брой рамена_8



DE Einmaliges Fördervolumen 1,2 cm³ **EN** One-time flow volume 1,2 cm³ **FR** Volume de pompage unique de 1,2 cm³ **ES** Volumen de descarga 1,2 cm³ **HR** Jednokratni volumen tlačenja 1,2 cm³ **HU** Egyszeri kiürítési térfogat 1,2 cm³ **RO** Volumul de descărcare unică 1,2 cm³ **BG** Еднократен обем на щамповане от 1,2 cm³



DE Einmaliges Fördervolumen 2,4 cm³ **EN** One-time flow volume 2,4 cm³ **FR** Volume de pompage unique de 2,4 cm³ **ES** Volumen de descarga 2,4 cm³ **HR** Jednokratni volumen tlačenja 2,4 cm³ **HU** Kiürítési térfogat 2,4 cm³ **RO** Volumul de descărcare unică 2,4 cm³ **BG** Еднократен обем на щамповане на 2,4 cm³



DE Einmalige Fördermenge 0,25 l **EN** One-time flow portion 0,25 l **FR** Portion de pompage unique 0,25 l **ES** Porción de prensado de 0,25 l cada vez **HR** Jednokratna porcija tlačenja 0,25 l **HU** Egyszeri kinyomott porció 0,25 l **RO** Porțiune de descărcare unică de 0,25 l **BG** Еднократно щамповане от 0,25 l



DE Einheiten und Messbereich 0 - 80 Meilen **EN** Units and measurement range 0 - 80 mil **FR** Unités et plage de mesure 0 - 80 mil **ES** Unidades y rango de medición 0 - 80 millas **HR** Jedinice i raspon mjerenja 0 - 80 milja **HU** Egységek és mérési tartomány 0 - 80 mérföld **RO** Unități și interval de măsurare 0 - 80 mile **BG** Единици и обхват на измерване 0 - 80 мили



DE Einheiten und Messbereich 0-2 mm **EN** Units and measurement range 0-2 mm **FR** Unités et plage de mesure 0-2 mm **ES** Unidades y rango de medición 0-2 mm **HR** Jedinice i mjerni raspon 0-2 mm **HU** Egységek és mérési tartomány 0-2 mm **RO** Unități și interval de măsurare 0-2 mm **BG** Единици и обхват на измерване 0-2 mm



DE Clip x2 **EN** Clip x2 **FR** Clip x2 **ES** Clip x2 **HR** Isječci x2 **HU** Gomb x2 **RO** Agrafă x2 **BG** Клип x2



DE Sechskantschlüssel **EN** Hex key **FR** Clé hexagonale **ES** Llave hexagonal **HR** Hex ključ **HU** Hatszögletű csavar kulcs **RO** Cheie hexagonală **BG** Шестостенен ключ



DE 4-Backen-Sperbolzen mit Innengewinde M10 x 1 **EN** 4-jaw tip with female thread M10 x 1 **FR** Embout à 4 mâchoires avec filetage femelle M10 x 1 **ES** Pasador de bloqueo de 4 mordazas con rosca interior M10 x 1 **HR** Stezni nastavak s 4-čeljusti s unutrašnjim navojem M10 x 1 **HU** 4-pofájú vég M10 x 1 belső menettel **RO** Cap cu 4 știfturi de blocare cu filet interior M10 x 1 **BG** 4 върха на стяга с вътрешна реза M10 x 1



DE Runde Spitze 12 mm mit 4 mm Kerbe mit Verriegelung **EN** 12 mm round tip with a 4 mm groove cut with a locking device **FR** Embout rond 12 mm avec encoche de 4 mm et verrouillage **ES** Cabeza redonda de 12 mm con corte de 4 mm con dispositivo de bloqueo **HR** Okrugli nastavak 12 mm s porezom od 4 mm s blokadom **HU** 12 mm-es kerek vég, 4 mm-es bemetszés, blokkolással **RO** Cap rotund de 12 mm cu tăiere de 4 mm cu dispozitiv de blocare **BG** Кръгъл връх 12 mm с разрез 4 mm със заключващо устройство



DE Runde Spitze 12 mm **EN** Round tip 12 mm **FR** Embout rond 12 mm **ES** Cabeza redonda 12 mm **HR** Okrugli nastavak 12 mm **HU** Kerek vég 12 mm **RO** Cap rotund 12 mm **BG** Кръгъл връх 12 mm



DE Maximaler Druck 4 bar **EN** Maximum pressure 4 bar **FR** Pression max. 4 bars **ES** Presión máxima 4 bar **HR** Maksimalni pritisak 4 bara **HU** Maximális nyomás 4 bar **RO** Presiune maximă 4 bar **BG** Налягане 4 бара



DE Maximaler Druck 700 bar **EN** Maximum pressure 700 bar **FR** Pression maximale 700 bars **ES** Presión máxima 700 bar **HR** Maksimalni pritisak 700 bara **HU** Maximális nyomás 700 bar **RO** Presiune maximă 700 bar **BG** Максимално налягане 700 бара

MAX
-1 Bar

DE Maximales Vakuum -1 bar **EN** Maximum underpressure -1 bar **FR** Vide maximum -1 bar **ES** Vacío máximo -1 bar **HR** Maksimalni podtlak -1 bar **HU** Maximális vákuum -1 bar **RO** Presiune maximă -1 bar **BG** Максимално под налягане -1 бар

HDPE

DE HDPE-Material **EN** Material HDPE **FR** Matériau HDPE **ES** Material HDPE **HR** Materijal HDPE **HU** HDPE anyag **RO** Material HDPE **BG** HDPE материал

NYLON

DE NYLON-Material **EN** Material NYLON **FR** Matériau NYLON **ES** Material NYLON **HR** Materijal NYLON **HU** NYLON anyag **RO** Material NYLON **BG** NYLON материал

STEEL

DE STEEL-Material **EN** Material STEEL **FR** Matériau STEEL **ES** Material ACERO **HR** Materijal STEEL **HU** STEEL anyag **RO** Material STEEL **BG** Стоманен материал

1.1 l

DE Fassungsvermögen 1,1 l **EN** Capacity 1.1 l **FR** Capacité 1,1 l **ES** Capacidad 1,1 l **HR** Zapremina 1,1 l **HU** Űrtartalom: 1,1 l **RO** Volum 1,1 l **BG** Вместимост 1,1 л

D:S
=12:1

DE Messbereich 12x1 **EN** Measurement field 12x1 **FR** Zone de mesure 12x1 **ES** Campo de medición 12x1 **HR** Mjerno polje 12x1 **HU** Mérési terület 12x1 **RO** Câmp de măsurare 12x1 **BG** 12x1 измервателно поле

45-90
cm

DE Einstellbare Pumpenlänge 45-90 cm **EN** Adjustable pump length 45-90 cm **FR** Longueur de la pompe réglable de 45 à 90 cm **ES** Longitud de la bomba ajustable 45-90 cm **HR** Podesiva duljina pumpe 45-90 cm **HU** Állítható pumpahossz 45-90 cm **RO** Lungime reglabilă a pompei 45-90 cm **BG** Регулируема дължина на помпата 45-90 см

9V

DE Batterie Typ 9 V **EN** Battery type 9V **FR** Type de pile 9 V **ES** Tipo de batería 9 V **HR** Tip baterije 9V **HU** 9 V-os elem **RO** Tipul bateriei 9 V **BG** Вид батерия 9V

CR
2032
3V

DE Batterie Typ CR2032 3 V **EN** Battery type CR2032 3 V **FR** Type de pile CR2032 3 V **ES** Tipo de pila CR2032 3 V **HR** Tip baterije CR2032 3V **HU** Az elem típusa CR2032 3 V **RO** Tipul bateriei CR2032 3 V **BG** Вид батерия CR2032 3V

ADBLUE

DE Flüssigkeitstyp ADBLUE **EN** Fluid type ADBLUE **FR** Type de fluide ADBLUE **ES** Fluido tipo ADBLUE **HR** Tip tekućine ADBLUE **HU** Folyadék típus ADBLUE **RO** Tipul de fluid ADBLUE **BG** ADBLUE вид течност

DIESEL

DE Flüssigkeitstyp DIESEL **EN** Fluid type DIESEL **FR** Type de fluide DIESEL **ES** Fluido tipo DIESEL **HR** Vrsta tekućine DIESEL **HU** Folyadék típus DIESEL **RO** Tipul de fluid DIESEL **BG** Вид течност за дизел

DOT
3/4/5

DE Bremsflüssigkeitstyp DOT 3, 4, 5 **EN** Type of brake fluid DOT 3, 4, 5 **FR** Type de liquide de frein DOT 3, 4, 5 **ES** Líquido de frenos tipo DOT 3, 4, 5 **HR** Vrsta kočione tekućine DOT 3, 4, 5 **HU** Fékfolyadék típus DOT 3, 4, 5 **RO** Lichid de frână tip DOT 3, 4, 5 **BG** Вид течност DOT 3, 4, 5

OIL

DE Flüssigkeitstyp OLEJ **EN** Fluid type OIL **FR** Type de fluide HUILE **ES** Fluido tipo ACEITE **HR** Vrsta tekućine ULJE **HU** Folyadék típus OLAJ **RO** Tipul de fluid OLEJ **BG** Вид течност МАСЛО

WATER

DE Flüssigkeitstyp WODA **EN** Fluid type WATER **FR** Type de fluide EAU **ES** Fluido tipo AGUA **HR** Vrsta tekućine VODA **HU** Folyadék típus VÍZ **RO** Tipul de fluid WODA **BG** Вид течност ВОДА

PETROL

DE Motortyp Benzin **EN** Engine type Gasoline **FR** Type de combustible Essence **ES** Tipo de motor Gasolina **HR** Tip motora Benzin **HU** Motor típus Benzin **RO** Tipul motorului Benzină **BG** Вид двигател Бензин

DIESEL

DE Motortyp DIESEL **EN** Engine type DIESEL **FR** Type de combustible DIESEL **ES** Tipo de motor DIESEL **HR** Tip motora DIESEL **HU** Motor típus DIESEL **RO** Tipul motorului DIESEL **BG** Вид двигател DIESEL

TYPE E

DE Splinttyp Type E **EN** Pin type Type E **FR** Type de bouchon Type E **ES** Tipo de clavija Tipo E **HR** Tip osigurača E **HU** E-típusú sasszeg **RO** Tip pin E **BG** Щипка тип E от тип E

BARREL
SIZE
50,60,
200 l

DE Gebindegrößen 50, 60, 200 l **EN** Barrel sizes 50, 60, 200 l **FR** Taille des fûts 50, 60, 200 l **ES** Tamaños de bidón 50, 60, 200 l **HR** Veličina bubnja 50, 60, 200 l **HU** 50, 60, 200 l-es hordóméreték **RO** Dimensiunea butoaielor 50, 60, 200 l **BG** Размери на барабана 50, 60, 200 l

M10
x1.0

DE Gewindegröße M10 x 1,0 **EN** Thread size M10 x 1.0 **FR** Taille du filetage M10 x 1,0 **ES** Tamaño de la rosca M10 x 1,0 **HR** Veličina navoja M10 x 1,0 **HU** Menetméret M10 x 1,0 **RO** Dimensiunea filetelui M10 x 1,0 **BG** Размер на резбата M10 x 1,0

M10
-M18

DE Gewindegröße M10-M18 **EN** Thread size M10-M18 **FR** Taille du filetage M10-M18 **ES** Tamaño de la rosca M10-M18 **HR** Veličina navoja M10-M18 **HU** Menetméret M10-M18 **RO** Dimensiunea filetelui M10-M18 **BG** Размер на резбата M10-M18

M12
x1.25

DE Gewindegröße M12 x 1,25 **EN** Thread size M12 x 1.25 **FR** Taille du filetage M12 x 1,25 **ES** Tamaño de la rosca M12 x 1,25 **HR** Veličina navoja M12 x 1,25 **HU** Menetméret M12 x 1,25 **RO** Dimensiunea filetelui M12 x 1,25 **BG** Размер на резбата M12 x 1,25

M12
-M18

DE Gewindegröße M12-M18 **EN** Thread size M12-M18 **FR** Taille du filetage M12-M18 **ES** Tamaño de rosca M12-M18 **HR** Veličina navoja M12-M18 **HU** Menetméret M12-M18 **RO** Dimensiunea filetelui M12-M18 **BG** Размер на резбата M12-M18

M14
x1.5

DE Gewindegröße M14 x 1,5 **EN** Thread size M14 x 1.5 **FR** Taille du filetage M14 x 1,5 **ES** Tamaño de la rosca M14 x 1,5 **HR** Veličina navoja M14 x 1,5 **HU** Menetméret M14 x 1,5 **RO** Dimensiunea filetelui M14 x 1,5 **BG** Размер на резбата M14 x 1,5

M18
x1.5

DE Gewindegröße M18 x 1,5 **EN** Thread size M18 x 1.5 **FR** Taille du filetage M18 x 1,5 **ES** Tamaño de la rosca M18 x 1,5 **HR** Veličina navoja M18 x 1,5 **HU** Menetméret M18 x 1,5 **RO** Dimensiunea filetelui M18 x 1,5 **BG** Размер на резбата M18 x 1,5

10x1
mm

DE Größe des Bandes 10x1 mm **EN** Belt size 10x1 **FR** Taille du ruban 10x1 mm **ES** Tamaño de la cinta 10x1 mm **HR** Veličina trake 10x1 mm **HU** Szalag méret 10x1 mm **RO** Dimensiunea benzii 10x1 mm **BG** Размер на лента 10x1 mm

10 mm
x2

DE Steckergöße 10 mm x 2 **EN** Plug size 10 mm x 2 **FR** Taille du bouchon 10 mm x 2 **ES** Tamaño del tapón 10 mm x 2 **HR** Veličina čepa 10 mm x 2 **HU** Dugó méret 10 mm x 2 **RO** Dimensiunea fișei 10 mm x 2 **BG** Размер на щепсела 10 mm x 2

13 mm
x2

DE Steckergöße 13 mm x 2 **EN** Plug size 13 mm x 2 **FR** Taille du bouchon 13 mm x 2 **ES** Tamaño del tapón 13 mm x 2 **HR** Veličina čepa 13 mm x 2 **HU** Dugó méret 13 mm x 2 **RO** Dimensiunea fișei 13 mm x 2 **BG** Размер на щепсела 13 mm x 2

8 mm
x2

DE Steckergöße 8 mm x 2 **EN** Plug size 8 mm x 2 **FR** Taille du bouchon 8 mm x 2 **ES** Tamaño del enchufe 8 mm x 2 **HR** Veličina čepa 8 mm x 2 **HU** Dugó méret 8 mm x 2 **RO** Dimensiunea fișei 8 mm x 2 **BG** Размер на щепсела 8 mm x 2

16mm
24mm

DE Schraubengrößen 16 und 24 mm **EN** Screw size 16 and 24 mm **FR** Taille des vis 16 et 24 mm **ES** Tamaños de tornillos 16 y 24 mm **HR** Veličina vijaka 16 i 24 mm **HU** Csavar méret 16 és 24 mm **RO** Dimensiunea șuruburilor 16 și 24 mm **BG** Размер на болта 16 и 24 mm

BRUSHLESS

DE Bürstenloser Motor **EN** Brushless motor **FR** Moteur sans balais **ES** Motor sin escobillas **HR** Motor bez četkica **HU** Kefe nélküli motor **RO** Motor fără perii **BG** Бесщетков двигател

VAG

DE VAG-Motoren **EN** VAG engines **FR** Moteurs VAG **ES** Motores VAG **HR** VAG motori **HU** VAG motorok **RO** Motoare VAG **BG** Двигатели VAG

scrapers
260 mm
225 mm

DE Abstreifer **EN** Scraper **FR** Raclours **ES** Rascadores **HR** Strugalice **HU** Kaparók **RO** Răzuitoare **BG** Скрепер

124
SIZES

DE Zugfedern 124 Größen **EN** Extension springs 124 sizes **FR** Ressorts de traction 124 tailles **ES** Muelles de expansión 124 tamaños **HR** Tlačne opruge 124 veličine **HU** Hosszabbító rugók 124 méret **RO** Arcuri de extensie 124 dimensiuni **BG** Дължителни пружини 124 размера

76
SIZES

DE Druckfedern 76 Größen **EN** Compression springs 76 sizes **FR** Ressorts de compression 76 tailles **ES** Muelles de compresión 76 tamaños **HR** Tlačne opruge 76 veličine **HU** Nyomórugók 76 méret **RO** Arcuri de compresie 76 dimensiuni **BG** Компресионни пружини 76 размера

K-KE-
JETRONIC
SIS

DE K-KEJETRONIC Einspritzsysteme **EN** K-KEJETRONIC injection systems **FR** Systèmes d'injection K-KEJETRONIC **ES** Sistemas de inyección K-KEJETRONIC **HR** K-KEJETRONIC sustavi ubrizgavanja **HU** K-KEJETRONIC befecskendező rendszerek **RO** Sisteme de injecție K-KEJETRONIC **BG** K-KEJETRONIC инжекционни системи

KE-
JETRONIC
KIC

DE KEJETRONIC KIC SIS Einspritzsysteme **EN** KEJETRONIC KIC SIS injection systems **FR** Systèmes d'injection KEJETRONIC KIC SIS **ES** Sistemas de inyección K-KEJETRONIC KIC SIS **HR** KEJETRONIC KIC SIS sustavi ubrizgavanja **HU** KEJETRONIC KIC SIS befecskendező rendszerek **RO** Sisteme de injecție KEJETRONIC KIC SIS **BG** KEJETRONIC KIC SIS инжекционни системи

L-
JETRONIC
LIW

DE LJETRONIC LIW Einspritzsysteme **EN** LJETRONIC LIW injection systems **FR** Systèmes d'injection LJETRONIC LIW **ES** LJETRONIC Sistemas de inyección LJETRONIC LIW **HR** LJETRONIC LIW sustavi ubrizgavanja **HU** LJETRONIC LIW befecskendező rendszerek **RO** Sisteme de injecție LJETRONIC LIW **BG** LJETRONIC LIW инжекционни системи

8 mm

DE Spalt 8 mm **EN** 8 mm gap **FR** Jeu de 8 mm **ES** 8 mm de separación **HR** Razmak od 8 mm **HU** 8 mm hézag **RO** Decalaj de 8 mm **BG** Пролука 8 mm

35-42
mm

DE Unterstützter Größenbereich 35 - 42 mm **EN** Range of supported sizes 35 - 42 mm **FR** Gamme de tailles prises en charge 35 - 42 mm **ES** Gama de tamaños 35 - 42 mm **HR** Raspon podržanih veličina 35 - 42 mm **HU** Támogatott mérettartomány 35 - 42 mm **RO** Gama de dimensiuni acceptate 35 - 42 mm **BG** Обхват на поддържаните размери 35 - 42 mm

13 mm

DE Breite der Blätter 13 mm **EN** Flap width 13 mm **FR** Largeur des feuilles 13 mm **ES** Anchura de la hoja 13 mm **HR** Širina lištica 13 mm **HU** Lapszélesség 13 mm **RO** Lățimea foilor 13 mm **BG** Ширина на острието 13 mm

19/22/
25/38 mm

DE Meißelbreiten 19, 22, 25, 38 mm **EN** Chisel widths 19, 22, 25, 38 mm **FR** Largeur du ciseau 19, 22, 25, 38 mm **ES** Anchos de cincel 19, 22, 25, 38 mm **HR** Širina dljeteta 19, 22, 25, 38 mm **HU** Vésőszélesség 19, 22, 25, 38 mm **RO** Lățimea daltei 19, 22, 25, 38 mm **BG** Ширина на длето 19, 22, 25, 38 mm

needle
210
mm

DE Spieß **EN** Spike **FR** Brochette **ES** Espiga **HR** Iгла s drškom **HU** Nyárs **RO** Ac trasat **BG** Шпир

WET/
GEL/
AGM/
Ca-Ca

DE Batterietyp WET, GEL, AGM, Ca-Ca **EN** Battery type WET, GEL, AGM, Ca-Ca **FR** Type de batterie WET, GEL, AGM, Ca-Ca **ES** Tipo de batería WET, GEL, AGM, Ca-Ca **HR** Tip baterije WET, GEL, AGM, Ca-Ca **HU** Akkumulátor típus WET, GEL, AGM, Ca-Ca **RO** Tip de baterie WET, GEL, AGM, Ca-Ca **BG** Тип батерия WET, GEL, AGM, Ca-Ca



DE Batterietyp WET **EN** Battery type WET **FR** Type de batterie WET **ES** Tipo de batería WET **HR** Tip baterije WET **HU** Akkumulátor típus WET **RO** Tip de baterie WET **BG** WET тип батерия



DE AV-Lüftung **EN** AV valve **FR** Évén AV **ES** Ventilador AV **HR** Ventil AV **HU** AV szelep **RO** Supapă AV **BG** AV клапан



DE Ausgang Maulschlüssel 17 mm **EN** Flat wrench outlet 17 mm **FR** Sortie pour la clé plate 17 mm **ES** Llave de salida 17 mm **HR** Izlaz pljosnati ključ od 17 mm **HU** Kímenet lapos kulcs 17 mm **RO** Ieșire cheie plată 17 mm **BG** Излезте с плосък ключ 17 мм



DE Ausgang Maulschlüssel 22 mm **EN** Flat wrench outlet 22 mm **FR** Sortie pour la clé plate 22 mm **ES** Llave de salida 22 mm **HR** Izlaz pljosnati ključ od 22 mm **HU** Kímenet lapos kulcs 22 mm **RO** Ieșire cheie plată 22 mm **BG** 22 мм плосък гаечен ключ



DE Ausgang für 1,2 Zoll Quadrat **EN** Square outlet 1,2 inch **FR** Sortie pour un carré de 1,2 pouce **ES** Salida para cuadrado de 1,2 pulgadas **HR** Kvadratni izlaz 1,2 inča **HU** 1,2 hüvelyk négyzet kímenet **RO** Ieșire pătrată 1,2 inch **BG** 1,2 инчов квадратен изход



DE Ausgang für 3,8 Zoll Quadrat **EN** Square outlet 3,8 inch **FR** Sortie pour un carré de 3,8 pouce **ES** Salida cuadrada de 3,8 pulgadas **HR** Kvadratni izlaz 3,8 inča **HU** 3,8 hüvelyk négyzet kímenet **RO** Ieșire pătrată 3,8 inch **BG** 3,8 инчов квадратен изход



DE LED-Anzeige **EN** LED display **FR** Affichage LED **ES** Pantalla LED **HR** LED zaston **HU** LED kijelző **RO** Afişaj LED **BG** LED дисплей



DE Schlauch 300 mm **EN** 300 mm hose **FR** Tuyau 300 mm **ES** Manguera 300 mm **HR** Crijevo 300 mm **HU** Tömlő 300 mm **RO** Furtun 300 mm **BG** 300 мм маркуч



DE Nadschlauch 280 mm **EN** Igelit hose 280 mm **FR** Tuyau en plastique 280 mm **ES** Manguera de agujas 280 mm **HR** Plastično crijevo 280 mm **HU** Műanyag tömlő 280 mm **RO** Furtun cu ac 280 mm **BG** 280 мм пластмасова тръба



DE Arbeitsbereich 10 - 180 mm **EN** Operating range 10-180 mm **FR** Plages de travail 10 - 180 mm **ES** Rango de trabajo 10-180 mm **HR** Radni raspon 10-180 mm **HU** Munkatartomány 10-180 mm **RO** Intervalul de lucru 10-180 mm **BG** Работен диапазон 10-180 мм



DE Arbeitsbereich 305 mm; **EN** Operating range 305 mm **FR** Plages de travail 305 mm **ES** Rango de trabajo 305 mm **HR** Radni raspon 305 mm **HU** Munkatartomány 305 mm **RO** Interval de lucru 305 mm **BG** Работен диапазон 305 мм



DE Arbeitsbereich 355 mm; **EN** Operating range 355 mm **FR** Plages de travail 355 mm **ES** Rango de trabajo 355 mm **HR** Radni raspon 355 mm **HU** Munkatartomány 355 mm **RO** Interval de lucru 355 mm **BG** Работен диапазон 355 мм



DE Arbeitsbereich der Spitze 18 - 54 mm; **EN** Operating range of the tip 18-54 mm **FR** Plage de travail de l'embout 18-54 mm **ES** Rango de trabajo de la punta 18-54 mm **HR** Radni raspon nastavka 18-54 mm **HU** A hegy munkatartománya 18-54 mm **RO** Intervalul de lucru al vârfului 18-54 mm **BG** Работният диапазон на върха 18-54 мм



DE Temperaturbereich -50 bis 125°C **EN** Temperature range -50 to 125°C **FR** Plage de température de -50 à 125°C **ES** Rango de temperatura -50 a 125°C **HR** Raspon temperatura -50 do 125°C **HU** Hőmérséklet-tartomány -50 és 125°C között **RO** Interval de temperatură -50 până la 125°C **BG** Температурен диапазон -50 до 125 °C



DE Innendurchmesser 30,5 mm **EN** Inner diameter 30.5 mm **FR** Diamètre intérieur 30,5 mm **ES** Diámetro interior 30,5 mm **HR** Unutarji promjer 30,5 mm **HU** Belső átmérő 30,5 mm **RO** Diametrul intern 30,5 mm **BG** Вътрешен диаметър 30,5 mm



DE Innendurchmesser 32,5 mm **EN** Outer diameter 32.5 mm **FR** Diamètre intérieur 32,5 mm **ES** Diámetro interior 32,5 mm **HR** Unutarji promjer 32,5 mm **HU** Belső átmérő 32,5 mm **RO** Diametrul intern 32,5 mm **BG** Вътрешен диаметър 32,5 mm



DE Schlauchdurchmesser 8 mm **EN** Hose diameter 8 mm **FR** Diamètre du tuyau 8 mm **ES** Diámetro de la manguera 8 mm **HR** Promjer crijeva 8 mm **HU** Tömlő átmérő 8 mm **RO** Diametrul furtunului 8 mm **BG** Диаметър на тръбата 8 мм



DE Stangendurchmesser 30-35mm 35-40mm 40-45mm **EN** Bar diameters 30-35mm 35-40mm 40-45mm **FR** Diamètre des tiges 30-35mm 35-40mm 40-45mm **ES** Diámetros de varilla 30-35mm 35-40mm 40-45mm **HR** Promjer drške 30-35mm 35-40mm 40-45mm **HU** Rúdátmérők 30-35mm 35-40mm 40-45mm **RO** Diametrul tijelor 30-35mm 35-40mm 40-45mm **BG** Диаметри на пръта 30-35mm_35-40mm_40-45mm



DE Automatische Verriegelung **EN** Automatic lock **FR** Verrouillage automatique **ES** Bloqueo automático **HR** Automatsko zaključavanje **HU** Automatikus blokkolás **RO** Blocare automată **BG** Автоматично заключаване



DE 4-Schneider-Bohrer **EN** 4-blade drill bit **FR** Foret à 4 tranchants **ES** Broca de cuatro cortes **HR** Svrđlo s 4 oštrice **HU** 4 élű fúró **RO** Burghiu cu 4 tăişuri **BG** Средло с 4 остриета



DE Bohrerlänge 120 **EN** Drill length 120 **FR** Longueur du foret 120 **ES** Longitud de la broca 120 **HR** Duljina svrdla 120 **HU** Fúrófej hosszúság 120 **RO** Lungime burghiu 120 **BG** Дължина на свердлото 120



DE Bohrerlänge 130 **EN** Drill length 130 **FR** Longueur du foret 130 **ES** Longitud de la broca 130 **HR** Duljina svrdla 130 **HU** Fúrófej hosszúság 130 **RO** Lungime burghiu 130 **BG** Дължина на свердлото 130



DE Lochsägertiefe 50 mm **EN** Keyhole depth 50 mm **FR** Profondeur de la scie cloche 50 mm **ES** Profundidad de la sierra 50 mm **HR** Dubina krune za bušenje otvora 50 mm **HU** Lyukfúrész mélység 50 mm **RO** Adâncimea ferăstrăului de găurit 50 mm **BG** 50 мм дълбочина на триона



DE Bohrtiefe 38 mm **EN** Drilling depth 38 mm **FR** Profondeur de perçage 38 mm **ES** Profundidad de perforación 38 mm **HR** Dubina bušenja 38 mm **HU** Fúrás mélység 38 mm **RO** Adâncimea de găurire 38 mm **BG** Дълбочина на пробиване 38 мм



DE HEX 7_16 Zoll **EN** HEX 7_16 inch **FR** HEX 7_16 pouce **ES** HEX 7_16 pulgadas **HR** HEX 7_16 ka **HU** HEX 7_16 hüvelyk **RO** HEX 7_16 inch **BG** HEX 7_16 инча



DE Anzahl der Klingen x4 **EN** Number of blades x4 **FR** Nombre de lames x4 **ES** Número de cuchillas x4 **HR** Broj oštrice x4 **HU** Élek száma x4 **RO** Număr de lame x4 **BG** Брой остриета x4



DE Anzahl der Zähne 10 TPI **EN** Number of teeth 10 TPI **FR** Nombre de dents 10 TPI **ES** Número de dientes 10 TPI **HR** Broj zuba 10 TPI **HU** Fogak száma 10 TPI **RO** Număr de dinți 10 TPI **BG** Брой зъби 10 TPI



DE Zahnform gefräst variabel **EN** Tooth shape milled variable **FR** Forme des dents fraisées variables **ES** Forma del diente fresado variable **HR** Oblik zuba glodani promjenjivi **HU** A fog alakja változó marású **RO** Forma dinților frezați, variabilă **BG** Формата на фрезеваните зъби, променлива



DE Zahnform geschliffen offen **EN** Tooth shape ground open **FR** Forme des dents meulées ouvertes **ES** Forma de los dientes rectificadas **HR** Oblik zuba brušeni tupi **HU** A fogak alakja csiszolt nyitott **RO** Forma dinților șlefuită, obtuză **BG** Формата на зъбите е смляна, отворени



DE Zahnform geschliffen konvergent **EN** Tooth shape ground convergent **FR** Forme des dents meulées convergentes **ES** Forma de los dientes convergentes molidos **HR** Oblik zuba brušeni konvergentni **HU** A fogak alakja csiszolt konvergens **RO** Forma dinților șlefuită, convergentă **BG** Формата на зъбите е шлифована, конвергентна



DE Laser-geschliffene Klinge **EN** Laser sharpened blade **FR** Lame affûtée au laser **ES** Cuchilla afilada por láser **HR** Laserski naoštrena oštrica **HU** Lézerrel élezett penge **RO** Lamă ascuțită cu laser **BG** Лазерно заточено острие



DE Werkstoff HCS 65Mn **EN** Material HCS 65Mn **FR** Matériau HCS 65Mn **ES** Material HCS 65Mn **HR** HCS 65Mn materijal **HU** Anyag HCS 65Mn **RO** Material HCS 65Mn **BG** HCS 65Mn материал



DE HSS-Material **EN** Material HSS **FR** Matériau HSS **ES** Material HSS **HR** Materijal HSS **HU** Anyag HSS **RO** Material HSS **BG** HSS материал



DE ABS + TPR Gehäuse-Material **EN** Body material ABS + TPR **FR** Matériau du corps ABS + TPR **ES** Material del cuerpo ABS + TPR **HR** Materijal tijela ABS TPR **HU** Ház anyag ABS + TPR **RO** Material corp ABS + TPR **BG** Материал на корпуса ABS + TPR



DE ABS-Gehäusematerial **EN** Body material ABS **FR** Matériau du corps ABS **ES** Material del cuerpo ABS **HR** Materijal tijela ABS **HU** Ház anyag ABS **RO** Material corp ABS **BG** Материал на корпуса от ABS



DE ALU + ABS Gehäuse-Material **EN** Body material ALU + ABS **FR** Matériau du corps ALU + ABS **ES** Material de la carcasa ALU + ABS **HR** Materijal tijela ALU ABS **HU** Ház anyag ALU + ABS **RO** Material corp ALU + ABS **BG** Материал на корпуса ALU + ABS



DE ALU + TPR Gehäuse-Material **EN** Body material ALU + TPR **FR** Matériau du corps ALU + TPR **ES** Material del cuerpo ALU + TPR **HR** Materijal tijela ALU TPR **HU** Ház anyag ALU + TPR **RO** Material corp ALU + TPR **BG** Материал на корпуса ALU + TPR



DE ALU-Gehäusematerial **EN** Body material ALU **FR** Matériau du corps ALU **ES** Material de la carcasa ALU **HR** Materijal tijela ALU **HU** Ház anyag ALU **RO** Material corp ALU **BG** Материал на корпуса ALU



DE PS + TPR Gehäuse-Material **EN** Body material PS + TPR **FR** Matériau du corps PS + TPR **ES** Material del cuerpo PS + TPR **HR** Materijal tijela PS TPR **HU** Ház anyag PS + TPR **RO** Material corp PS + TPR **BG** Материал на корпуса PS + TPR



DE Material der Klinge SK2H **EN** Blade material SK2H **FR** Matériau de la lame SK2H **ES** Material de la hoja SK2H **HR** Materijal oštrice SK2H **HU** Penge anyag SK2H **RO** Material lamă SK2H **BG** Материал на острието SK2H



DE Material der Klinge SK5 **EN** Blade material SK5 **FR** Matériau de la lame SK5 **ES** Material de la hoja SK5 **HR** Materijal oštrice SK5 **HU** Penge anyag SK5 **RO** Material lamă SK5 **BG** Материал на острието SK5



DE Führungsschienenmaterial Metall **EN** Guide bar material metal **FR** Matériau du guidage : métal **ES** Material de la guía metal **HR** Materijal vodilice metal **HU** Vezetőcsín anyag fém **RO** Material ghidaj - metal **BG** Метален направляващ материал

MAX
12 500
RPM

DE Max. Drehzahl 12 500 U/min **EN** Max. 12 500 RPM **FR** Vitesse max 12 500 RPM **ES** Velocidad máxima 12 500 RPM **HR** Maksimalni broj okretaja 12 500 RPM **HU** Maximális fordulatszám 12 500 RPM **RO** Viteza maximă 12 500 RPM **BG** Максимални обороти 12 500 RPM

MAX
4500
RPM

DE Max. Drehzahl 4 500 U/min **EN** Max. 4500 RPM **FR** Vitesse max 4500 RPM **ES** Velocidad máxima 4500 RPM **HR** Maksimalni broj okretaja 4500 RPM **HU** Maximális fordulatszám 4500 RPM **RO** Viteza maximă 4500 RPM **BG** Максимални обороти 4500 RPM

MAX
8500
RPM

DE Max. Drehzahl 8 500 U/min **EN** Max. 8500 RPM **FR** Vitesse max 8500 RPM **ES** Velocidad máxima 8500 RPM **HR** Maksimalni broj okretaja 8500 RPM **HU** Maximális fordulatszám 8500 RPM **RO** Viteza maximă 8500 RPM **BG** Максимални обороти 8500 RPM

BELT
CUT

DE Gurt-Seitenschneider **EN** Side belt cutter **FR** Coupe-ceinture latérale **ES** Cortadora de cinta lateral **HR** Bočni rezač remena **HU** Szalagvágó oldalsó olló **RO** Cuțit de tăiat lateral bandă **BG** Фреза за страничен колан

ANTI-RUST
BLADE

DE Korrosionsschutz Klinge **EN** Anti-corrosion blade **FR** Lame anti-corrosive **ES** Hoja anticorrosiva **HR** Antikoroziivna oštrica **HU** Korrózióálló penge **RO** Lamă anticorozivă **BG** Антикорозионно острие

CAN
OPENER

DE Dosenöffner **EN** Can opener **FR**ouvre-boîtes **ES** Abrelatas **HR** Otvarač limenki **HU** Konzervnyitó **RO** Deschizător de cutii metalice **BG** Оtvарачка за консерви

PLASTIC

DE Kunststoff Klinge **EN** Plastic saw blade **FR** Lame en plastique **ES** Hoja de plástico **HR** Plastični list pile **HU** Műanyag penge **RO** Pânză de ferăstrău din plastic **BG** Пластмасов трион

MULTI
STOP

DE Positionen der Klinge **EN** Blade positions **FR** Positions de la lame **ES** Posiciones de las cuchillas **HR** Položaji oštrica **HU** Penge pozíciói **RO** Poziții ale lamei **BG** Позиции на острието

LOCK-
BUTTON

DE Sperrtaste **EN** Locking button **FR** Bouton de verrouillage **ES** Botón de bloqueo **HR** Gumb za zaključavanje **HU** Blokkoló gomb **RO** Buton de blocare **BG** Бутон за заключване

XTREME
SHARP
EDGE

DE Klinge Typ XSE **EN** Blade type XSE **FR** Type de lame XSE **ES** Cuchilla tipo XSE **HR** Tip oštrice XSE **HU** Penge típus XSE **RO** Tipul de lamă XSE **BG** Острие тип XSE

FOLDABLE

DE Zusammenklappbar **EN** Folded **FR** Pliable **ES** Plegable **HR** Sklopjivi **HU** Összecsukható **RO** Pliabilă **BG** Сгъване

M16

DE Halterung M16 **EN** Handle M16 **FR** Support M16 **ES** M16 mango **HR** Držač M16 **HU** Tokmány M16 **RO** Suport M16 **BG** Държач M16

DE Zylindrisches Spannfutter mit Fase **EN** Cylindrical handle with chamfer **FR** Poignée cylindrique avec chanfrein **ES** Mandril cilíndrico con chaflán **HR** Upuštač **HU** Hengeres tokmány fázisolt **RO** Suport cilindric cu șanfenare **BG** Цилиндрична дръжка с фаска

T-type

DE T-Griff **EN** Handle type T **FR** Poignée en T **ES** Mango en T **HR** T-ručka **HU** T-fogantyú; **RO** Suport de tip T **BG** T-дръжка

SL

DE Schraubendreher SL **EN** Screwdriver SL **FR** Tournevis SL **ES** Destornillador SL **HR** SL odvijač **HU** SL csavarhúzó **RO** Șurubelniță SL **BG** SL отвертка

EASY
CHANGE

DE Klingenwechsel - einfach **EN** Blade replacement - easy **FR** Remplacement de la lame - facile **ES** Sustitución de la cuchilla - fácil **HR** Zamjena oštrice - jednostavna **HU** Pengecsere - egyszerű **RO** Înlocuirea lamei - ușoară **BG** Смяна на острието - лесно

VHM

DE Hartmetall **EN** Sintered carbide **FR** Carbone cémenté **ES** Carburo **HR** Sintetirani karbid **HU** Karbid **RO** Carbură **BG** Волфрамов карбид печен

20 KG
PULLFORCE
RESISTANCE

DE Klingenauswurfschutz 20 kg **EN** Protection against blade ejection 20 kg **FR** Protection contre l'éjection de la lame 20 kg **ES** Protección contra la expulsión de la hoja 20 kg **HR** Zaštita od izbacivanja oštrice 20 kg **HU** Pengekibodás elleni védelem 20 kg **RO** Protecție împotriva ejectării lamei 20 kg **BG** Защита срещу изхвърляне на острието 20 кг

60 KG
PULLFORCE
RESISTANCE

DE Klingenauswurfschutz 60 kg **EN** Protection against blade ejection 60 kg **FR** Protection contre l'éjection de la lame 60 kg **ES** Protección contra la expulsión de la hoja 60 kg **HR** Zaštita od izbacivanja oštrice 60 kg **HU** Pengekibodás elleni védelem 60 kg **RO** Protecție împotriva ejectării lamei 60 kg **BG** Защита срещу удължаване на острието 60 кг

DE Siebfänger innen **EN** Mesh inside **FR** Tamis à l'intérieur **ES** Tamiz interior **HR** Sito unutra **HU** Szita belül **RO** Sita în interior **BG** Цедка отвътре

DE Adapter für Steckschlüssel und Schraubendrehereinsätze **EN** Adapter for sockets and screwdriver tips **FR** Adaptateur pour douilles et embouts de tournevis **ES** Adaptador para llaves de vaso y puntas de destornillador **HR** Adapter za nastavke i vrhove za odvijanje **HU** Adapter dugókulcsokhoz és csavarhúzó bitekhez **RO** Adaptor pentru prize și biți de șurubelniță **BG** Адаптор за вложки, бормашина

VELCRO

DE Klettverschluss **EN** Velcro **FR** Velcro **ES** Velcro **HR** Čičak **HU** Tépőzár **RO** Scai **BG** Велкро лента

BELT
HANGER

DE Gürtelclip **EN** Belt clip **FR** Clip de ceinture **ES** Clip para el cinturón **HR** Korpa za remen **HU** Övcsipes **RO** Clemă pentru curea **BG** Щипка за колан

1x140
mm

DE 1 Schublade Höhe 140 mm **EN** 1 drawer 140 mm high **FR** 1 tiroir hauteur de 140 mm **ES** 1 cajón altura 140 mm **HR** 1 ladi-ca visine 140 mm **HU** 1 db 140 mm magas fiók **RO** 1 sertar înălțime 140 mm **BG** Височина на 1 çekмедже 140 мм

2
modules

DE 2 Module **EN** 2 modules **FR** 2 modules **ES** 2 módulos **HR** 2 modula **HU** 2 modul **RO** 2 module **BG** 2 модула

AUTO
LOCK

DE Selbstnivellierendes Schloss **EN** Self-leveling lock **FR** Verrouillage d'autonivellement **ES** Cerradura autonivelante **HR** Blokada samoniveliranja **HU** Önszintezés blokád **RO** Blocaj cu auto-nivelare **BG** Блокировка самонивелираща

max 10 h

DE Arbeitszeit 10h **EN** Working time 10h **FR** Temps de travail 10h **ES** Tiempo de funcionamiento 10h **HR** Vrijeme rada 10h **HU** Működési idő 10h **RO** Timp de lucru 10h **BG** Работно време 10h

±0,3
mm/m

DE Genauigkeit 0,3 mm/m **EN** Accuracy 0,3 mm/m **FR** Précision 0,3 mm/m **ES** Precisión 0,3 mm/m **HR** Preciznost 0,3 mm/m **HU** Pontosság 0,3 mm/m **RO** Precizie 0,3 mm/m **BG** Точност 0,3 mm/m

WOODEN
WORKTOP
10 mm

DE Arbeitsplatte aus Holz mit 10 mm Dicke **EN** Wooden worktop 10 mm thick **FR** Plan de travail en bois de 10 mm d'épaisseur **ES** Encimera de madera de 10 mm de grosor **HR** Drvena radna ploha debljine 10 mm **HU** 10 mm vastag fa munkalap **RO** Blat de lucru din lemn, grosime 10 mm **BG** Дървен работен плот с дебелина 10 мм

505-520
Nm

DE Wellenlänge 505-520 Nm **EN** Wavelength 505-520 Nm **FR** Longueur d'onde 505-520 Nm **ES** Longitud de onda 505-520 Nm **HR** Valne duljine 505-520 Nm **HU** Hullámhossz 505-520 Nm **RO** Lungime de undă 505-520 Nm **BG** Дължина на вълната 505-520 Nm

FLEXIBLE
HEAD

DE Flexibles Gelenk **EN** Flexible head **FR** Joint flexible **ES** Junta flexible **HR** Fleksibilan zglobov **HU** Rugalmas csukló **RO** Articulație flexibilă **BG** Гъвкаво съединение

THICKNESS
1,0 mm

DE Dicke des Metallprofils 1 mm **EN** Thickness of metal profiles - 1mm **FR** Épaisseur de profilés métalliques 1 mm **ES** Espesor del perfil metálico 1 mm **HR** Debljina metalnih profila 1 mm **HU** A fém profilok vastagsága 1 mm **RO** Grosime profiluri din metal 1 mm **BG** Дебелина на металния профил 1 mm

20

DE Anzahl der Drähte 20 **EN** Wire quantity 20 **FR** Quantité de fil 20 **ES** Cantidad de alambre 20 **HR** Količina žice 20 **HU** Drótok száma 20 **RO** Cantitate de sârmă 20 **BG** Брой жици 20

GREEN
LASER

DE Grünes Laserlicht **EN** Green laser light **FR** Lumière laser verte **ES** Luz láser verde **HR** Zeleno svjetlo lasera **HU** Zöld lézerfény **RO** Lumină laser verde **BG** Зелена лазерна светлина

RED
LASER

DE Rotes Laserlicht **EN** Red laser light **FR** Lumière laser rouge **ES** Luz láser roja **HR** Crveno svjetlo lasera **HU** Vörös lézerfény **RO** Lumină laser roșie **BG** Червена лазерна светлина

max
15 kg

DE Maximale Belastung 15 kg **EN** Maximum load 15 kg **FR** Capacité de charge maximale 15 kg **ES** Carga máxima de 15 kg **HR** Maksimalno opterećenje 15 kg **HU** Maximális terhelés 15 kg **RO** Sarcină maximă 15 kg **BG** Максимално натоварване 15 kg

MAX 25 kg

DE Maximale Tragfähigkeit der Schubladen 25 kg **EN** Maximum load capacity of drawers 25 kg **FR** Capacité de charge maximale des tiroirs 25 kg **ES** Capacidad de carga máxima de los cajones 25 kg **HR** Maksimalna nosivost ladica 25 kg **HU** A fiókok maximális terhelhetősége 25 kg **RO** Capacitate maximă de încărcare a sertarelor 25 kg **BG** Максимална товароносимост на çekмеджетата 25 кг

ABS
ELASTOMER

DE Starke Verschlüsse - ABS Elastomer **EN** Strong locks - ABS Elastomer **FR** Fixations solides - Elastomère **ES** Sujetadores resistentes - Elastómero **HR** Jako zakopčavanje - ABS Elastomer **HU** Erős záróelemek - ABS elasztomer **RO** Elemente de fixare puternice - ABS Elastomer **BG** Здрави крепелни елементи - ABS еластомер

Side vertical

DE Seitliche Lot-Messung **EN** Side vertical measurement **FR** Mesure latérale de la verticale **ES** Medición vertical lateral **HR** Bočno mjerenje vertikalne **HU** Oldalirányú függőleges mérés **RO** Măsurare laterală verticală **BG** Странично вертикално измерване

Cross &
Side vertical

DE Kreuz- und seitliche Lot-Messung **EN** Cross and side vertical measurement **FR** Mesure transversale et latérale de la verticale **ES** Medición de la plomada transversal y lateral **HR** Krizno i bočno mjerenje vertikalne **HU** Keresztirányú és oldalirányú függőleges mérés **RO** Măsurare transversală și laterală pe verticală **BG** Измерване на напречен и страничен отвес

Cross

DE Kreuzmessung **EN** Cross measurement **FR** Mesure croisée **ES** Medición cruzada **HR** Krizno mjerenje **HU** Keresztmérés **RO** Măsurare transversală **BG** Кръстосано измерване

Vertical

DE Lot-Messung **EN** Vertical measurement **FR** Mesure de la verticale **ES** Medición de la plomada **HR** Mjerenje vertikalne **HU** Fügőleges mérés **RO** Măsurare pe verticală **BG** Вертикално измерване



DE 360°-Geraden- und seitliche Lot-Messung **EN** 360° horizontal and side vertical measurement **FR** Mesure du plan horizontal 360° et mesure latérale de la verticale **ES** Nivel de 360° y medición de la plomada lateral **HR** Mjerenje horizontale 360° i bočno vertikalne **HU** 360°-os szintesés és oldalsó függőleges mérés **RO** Măsurarea nivelului de 360° și măsurare laterală pe verticală **BG** Измерване на ниво и страничен щраг на 360°



DE Die solide Dichtung bietet Schutz vor Staub und Wasser **EN** Solid gasket ensures dust and water resistance **FR** Le joint solide assure une résistance à la poussière et à l'eau **ES** La junta sólida proporciona resistencia al polvo y al agua **HR** Čvrsta brtva jamči zaštitu od prašine te zaštitu od utjecaja vode **HU** Por- és vízállóságot biztosít tömör tömítés **RO** Garnitura solidă asigură rezistență la praf și apă **BG** Твърдото уплътнение осигурява устойчивост на прах и вода



DE 360°-Geraden-Messung **EN** 360° horizontal measurement **FR** Mesure du plan horizontal 360° **ES** Medición de nivel en 360° **HR** Mjerenje horizontale 360° **HU** 360°-os szintesés **RO** Măsurarea nivelului de 360° **BG** 360° измерване на нивото



DE Kann für den Transport abgebaut werden **EN** Possibility of disassembling for transport **FR** Peut être démonté pour le transport **ES** Puede desmontarse para su transporte **HR** Mogućnost rastavljanja za potrebe transporta **HU** Szállításhoz szétszerelhető **RO** Poate fi dezamblat pentru transport **BG** Може да се разглобява за транспортиране



DE Geraden-Messung **EN** Horizontal measurement **FR** Mesure du plan horizontal **ES** Medición del nivel **HR** Mjerenje horizontale 360° **HU** Vízszint mérés **RO** Măsurarea nivelului **BG** Измерване на нивото



DE Langlebige ABS-Verschlüsse **EN** Durable ABS locks **FR** Fixations durables en ABS **ES** Cierres de ABS duraderos **HR** Izdržljivo kopčanje s ABS **HU** Tartós ABS záróelemek **RO** Dispozitive de fixare durabile din ABS **BG** Издръжливи ABS крепежни елементи



DE Langsames Schließen der Schubladen **EN** Slow close of drawers **FR** Fermeture lente des tiroirs **ES** Cierre lento de los cajones **HR** Usporeno zatvaranje ladica **HU** Lassan záródó fiókok **RO** Închiderea lentă a sertarelor **BG** Бавно затваряне на чекмеджетата



DE Verstärkte Wandkonstruktion **EN** Reinforced wall structure **FR** Construction de murs renforcés **ES** Construcción de paredes reforzadas **HR** Pojačana konstrukcija zidova **HU** Megerősített falszerkezet **RO** Construcție de pereți ranforșați **BG** Конструкция на подсилена стена



DE Höhenverstellung des Stativs **EN** Tripod height adjustment **FR** Réglage de la hauteur du trépied **ES** Ajuste de la altura del trípode **HR** Podešavanje visine stativa **HU** Beállítható állványmagasság **RO** Reglarea înălțimii tripodului **BG** Регулиране на височината на статива



DE Innerer Absetzring **EN** Inner Seeger ring **FR** Bague intérieure **ES** Anillo interior **HR** Unutarnji sigurnosni prsten **HU** Belső rögzítőgyűrű **RO** Inel interior **BG** Вътрешен фиксиращ пръстен



DE Selbstnivellierung +/-4 **EN** Self-leveling +/-4 **FR** Auto-nivellement +/-4 **ES** Autonivelación +/-4 **HR** Samoniveliranje +/-4 **HU** Önszintesés +/-4 **RO** Auto-nivelare +/-4 **BG** Самонивелиране +/-4



DE Äußerer Absetzring **EN** Outer Seeger ring **FR** Bague extérieure **ES** Anillo exterior **HR** Unutarnji sigurnosni prsten **HU** Belső rögzítőgyűrű **RO** Inel exterior **BG** Външен фиксиращ пръстен



DE Magnetische Halterung **EN** Magnetic handle **FR** Support magnétique **ES** Soporte magnético **HR** Magnetska drška **HU** Mágneses tartóelem **RO** Suport magnetic **BG** Магнитен държач



DE Adapter für Schraubendreherbits 1/4" x 19 mm **EN** 1/4" x 19 mm screwdriver bits adapters **FR** Adaptateurs pour embouts de tournevis 1/4" x 19 mm **ES** Adaptador para puntas de destornillador 1/4" x 19 mm **HR** Adapter za bitove 1/4" x 19 mm **HU** Bithegy tartó adapter 1/4" x 19 mm **RO** Adaptoare pentru biți de șurubelniță de 1/4" x 19 mm **BG** 1/4" x 19 mm адаптери за отвертка



DE Nettogewicht des Schrankes 65 kg **EN** Net weight of the cabinet 65 kg **FR** Poids net de l'armoire 65 kg **ES** Peso neto del armario 65 kg **HR** Neto težina ormarića 65 kg **HU** A fiók nettó súlya 65 kg **RO** Greutatea netă a dulapului 65 kg **BG** Нетно тегло на шкафа 65 kg



DE Adapter für Aufsätze 1/2" x 19 mm **EN** 1/2" x 19 mm sockets adapters **FR** Adaptateur pour douille 1/2" x 19 mm **ES** Adaptador para toma de corriente de 1/2" x 19 mm **HR** Adapter za nastavke 1/2" x 19 mm **HU** Adapter 1/2" x 19 mm-es aljzathoz **RO** Adaptor pentru biți 1/2" x 19 mm **BG** Адаптер за гнездо 1/2" x 19 mm



DE Robuste Abdeckung **EN** Durable cover **FR** Couverture robuste **ES** Cubierta robusta **HR** Izdržljiv poklopac **HU** Strapabíró borítás **RO** Capac robust **BG** Издръжлив капак



DE Stromversorgung 2 x 1Ah AA Ni-Mh **EN** 2 x 1Ah AA Ni-Mh battery **FR** Alimentation électrique 2 x 1Ah AA Ni-Mh **ES** Alimentación 2 x 1Ah AA Ni-Mh **HR** Napajanje 2 x 1Ah AA Ni-Mh **HU** Áramellátás 2 x 1Ah AA Ni-Mh **RO** Sursă de alimentare 2 x 1Ah AA Ni-Mh **BG** Захранване 2 x 1Ah AA Ni-Mh



DE Kalt gesintert **EN** Cold pressed sintered **FR** Fritté à froid **ES** Sinterizado en frío **HR** Hladno prešanje **HU** Hidegen szinterezett **RO** Sinterizat la rece **BG** Студено синтеровани



DE Heiß gesintert **EN** Hot press sintered **FR** Fritté à chaud **ES** Sinterizado en caliente **HR** Vruće prešanje **HU** Melegen szinterezett **RO** Sinterizat la cald **BG** Горещо синтеровани



DE Große, gummibeschichtete Räder **EN** Large, rubber coated wheels **FR** Grandes roues recouvertes de caoutchouc **ES** Ruedas grandes con revestimiento de goma **HR** Veliki kotači prekriveni gumom **HU** Nagyméretű, gumborítású kerekek **RO** Roți mari, acoperite cu cauciuc **BG** Големи колела с гумено покритие



DE Dieser Produktkatalog wurde von GTV Polen, dem exklusiven Vertriebspartner von Högert Technik in Polen, erstellt und stellt kein Angebot im Sinne des Zivilgesetzbuches dar. GTV Poland ist ständig bestrebt, sein Angebot zu verbessern und an die sich ändernden Marktbedürfnisse anzupassen. Daher behält sich GTV Poland das Recht vor, Änderungen im präsentierten Sortiment vorzunehmen und ist nicht verantwortlich für die mangelnde Verfügbarkeit der in dieser Publikation vorgestellten Produkte. GTV Poland behält sich das Recht vor, (ohne Vorankündigung) Änderungen am präsentierten Sortiment in Bezug auf technische Parameter und Produktspezifikationen vorzunehmen. Die in diesem Katalog vorgestellten Artikel können in der Tat von der auf den Fotos gezeigten Ausführung abweichen (insbesondere in Bezug auf äußere Merkmale, d. h. Größe, Farbe, Art der Verpackung, Anzahl der Artikel in einer Packung) und sich auch in Bezug auf technische Parameter unterscheiden. Aufgrund der verwendeten Drucktechnik kann die Farbe des vorliegenden Produkts vom Original abweichen. GTV Poland haftet nicht für Druckfehler oder Schäden, die sich aus der Verwendung der in dieser Publikation enthaltenen Informationen ergeben. Diese Veröffentlichung ist für die Geschäftspartner von GTV Polen bestimmt.

EN This product catalogue has been prepared by GTV Poland which is the exclusive distributor of Högert Technik products in Poland and it does not constitute an offer within the meaning of the Civil Code. GTV Poland is constantly striving to improve its offer by adapting it to the changing market needs, therefore it reserves the right to introduce changes in the presented assortment and waives liability for lack of the products presented in this publication. GTV Poland reserves the right to introduce (without notice) changes to the presented assortment in terms of technical parameters and product specifications. The articles presented in this catalogue may in fact differ from the design shown in the photographs (especially as regards external features, i.e. size, colour, packaging, number of items in a package) and also in terms of technical parameters. Variations from the colours represented here can occur, subject to printing techniques. GTV Poland waives any liability for printing errors or any damages resulting from the use of the information contained in this publication. This publication is intended for GTV Poland business partners.

FR Le catalogue de produits que vous obtenez, a été préparé par la GTV Poland, qui est le distributeur exclusif des produits Högert Technik en Pologne et il ne constitue pas une offre au sens du Code civil. La GTV Poland s'efforce constamment d'améliorer son offre, en l'adaptant aux besoins changeants du marché, en conséquence elle se réserve le droit d'apporter des modifications à l'assortiment de produits présentée et n'est pas tenue responsable du manque de disponibilité des produits inclus dans la présente publication. La GTV Poland se réserve le droit d'apporter (sans préavis) des modifications à l'assortiment de produits présenté en termes de paramètres techniques et de spécifications de produits. Les produits présentés dans le présent catalogue peuvent en effet différer du motif indiqué sur les photos (notamment en ce qui concerne les caractéristiques extérieures, c'est-à-dire la taille, la couleur, le mode d'emballage, le nombre de produits dans l'emballage) et également différer du point de vue de paramètres techniques. Vue la technique d'impression utilisée, la couleur du produit présenté peut différer de l'original. La GTV Poland n'est pas tenue responsable ni des erreurs d'impression, ni des dommages résultant de l'utilisation des informations contenues dans cette publication. La présente publication est adressée aux partenaires commerciaux de la GTV Poland.

ES Este catálogo de productos ha sido preparado por GTV Poland, el distribuidor exclusivo de los productos Högert Technik en Polonia y no constituye una oferta en el sentido del Código Civil. GTV Poland se esfuerza constantemente por mejorar su oferta adaptándola a las necesidades cambiantes del mercado, por lo que se reserva el derecho de introducir cambios en la oferta presentada y no se hace responsable de la falta de disponibilidad de los productos presentados en esta publicación. GTV Poland se reserva el derecho de introducir (sin previo aviso) cambios en la oferta presentada dentro de parámetros técnicos y especificaciones de los productos. De hecho, los artículos presentados en este catálogo pueden diferir del diseño mostrado en las fotografías (en particular en lo que respecta a las características externas, es decir, el tamaño, el color, el método de embalaje, el número de artículos en un paquete) y también difieren en términos de parámetros técnicos. Debido a la técnica de impresión utilizada, el color del producto presentado puede diferir del original. GTV Poland no se responsabiliza de los errores de impresión ni de los daños derivados del uso de la información contenida en esta publicación. Esta publicación está destinada a los socios comerciales de GTV Poland y todas las empresas del grupo.

HR Ovaj katalog proizvoda pripremila je GTV Poland, koja je ekskluzivni distributer proizvoda Högert Technik u Poljskoj i ne predstavlja ponudu u smislu gradanskog zakonika. GTV Poland neprestano radi na usavršavanju svoje ponude, prilagodavajući je promjenjivim potrebama tržišta, stoga zadržava pravo na izmjene prezentiranog asortimana i ne snosi odgovornost za nedovoljnu dostupnost proizvoda iz ove publikacije. GTV Poland zadržava pravo unošenja (bez prethodne najave) promjena prikazanog asortimana u smislu tehničkih parametara i specifikacija proizvoda. Proizvodi prikazani u ovom katalogu mogu se u stvari razlikovati u odnosu na uzorke navedene na fotografijama (osobito kada su u pitanju vanjske značajke, tj. veličina, boja, način pakiranja, broj artikala u pakiranju), a također se razlikuju i po tehničkim parametrima. Obzirom na tehniku tiska, boja predstavljenog proizvoda može se razlikovati u odnosu na original. GTV Poland nije odgovorna za tiskarske greške, kao ni za bilo kakvu štetu nastalu korištenjem podataka sadržanih u ovoj publikaciji. Ova publikacija namijenjena je komercijalnim partnerima GTV -a u Poljskoj.

HU Ezt a termékkatalógust a GTV Poland cég készítette, amely a Högert Technik termékek kizárólagos forgalmazója Lengyelországban, és nem minősül a Polgári Törvénykönyv rendelkezéseinek értelmében vett ajánlatnak. A GTV Poland folyamatosan arra törekszik, hogy a változó piaci igényekhez igazítsa kínálatát, ezért fenntartja a jogot a bemutatott termékvalaszték módosítására, és nem vállal felelősséget a kiadványban szereplő termékek elérhetőségének hiányáért. A GTV Poland fenntartja a jogot, hogy a bemutatott termékvalasztékban előzetes értesítés nélkül változtatásokat vezessen be a műszaki paraméterek és a termékleírások tekintetében. A katalógusban bemutatott árucikkek a valóságban eltérhetnek a fényképeken feltüntetett mintáktól (különösen a külső jellemzők, azaz a méret, a szín, a csomagolás módja, a csomagolásban lévő tételek száma tekintetében), és azoktól műszaki paraméterek tekintetében is különbözhetnek. Az alkalmazott nyomtatási technikára való tekintettel a bemutatott termék színe eltérhet az eredetitől. A GTV Poland nem vállal felelősséget a nyomtatási hibákért, valamint a jelen kiadványban szereplő információk felhasználásából eredő esetleges károkért. A kiadvány a GTV Poland kereskedelmi partnereinek készült.

RO Acest catalog de produse a fost pregătit de GTV Poland, care este distribuitorul exclusiv al produselor Högert Technik în Polonia și nu constituie o ofertă în sensul Codului Civil. GTV Poland se străduiește în mod constant să își îmbunătățească oferta prin adaptarea acesteia la nevoile în schimbare ale pieței, de aceea își rezervă dreptul de a introduce modificări în sortimentul prezentat și nu este responsabilă pentru lipsa de disponibilitate a produselor prezentate în această publicație. GTV Poland își rezervă dreptul de a introduce (fără preaviz) modificări în gama prezentată în ceea ce privește parametrii tehnici și specificațiile produselor. Articolele prezentate în acest catalog pot să difere în realitate de modelul prezentat în fotografii (în special în ceea ce privește caracteristicile exterioare, de exemplu, dimensiunea, culoarea, modul de ambalare, numărul de articole dintr-un ambalaj) și, de asemenea, pot fi diferite în ceea ce privește parametrii tehnici. Din cauza tehnicii de imprimare utilizate, culoarea produsului prezentat poate varia față de cea a originalului. GTV Poland nu este responsabil pentru erorile de tipar sau pentru orice daune rezultate din utilizarea informațiilor conținute în această publicație. Această publicație este destinată partenerilor de afaceri ai GTV Poland.

BG Този продуктов каталог е изготвен от GTV Poland, който е изключителен дистрибутор на продуктите на Högert Technik в Полша и не представлява oferta по смисъла на Гражданския кодекс. GTV Poland непрекъснато се стреми да подобрява своята oferta, като я адаптира към променящите се нужди на пазара, поради което си запазва правото да прави промени в представената oferta и не носи отговорност за липсата на наличност на продуктите, включени в тази публикация. GTV Poland си запазва правото да въвежда (без предизвестие) промени в представения асортимент по отношение на технически параметри и спецификации на продукта. Артикулите, представени в този каталог, могат действително да се различават от модела, посочен на снимките (по-специално що се отнася до външни характеристики, т.е. размер, цвят, начин на опаковане, брой артикули в опаковката) и също така да се различават по отношение на техническите параметри. Поради използваната техника на печат, цветът на представения продукт може да се различава от оригинала. GTV Poland не носи отговорност за печатни грешки, както и за всякакви щети, произтичащи от използването на информацията, съдържаща се в тази публикация. Тази публикация е предназначена за търговски партньори на GTV Poland.



Hөгert Technik GmbH

Pariser Platz 6a, 10117 Berlin, Germany

Distribution in Poland GTV, Przejazdowa Street 21, 05-800 Pruszków, Poland



GTV Poland sp. z o.o. sp.k.
Przejazdowa 21, 05-800 Pruszków, Poland
+48 22 44 47 500



140073, Московская область, город Люберцы, рабочий поселок
Томилино, микрорайон Птицефабрика, литер 7А
+7 495 640 15 88



GTV Croatia d.o.o.
Kovinska 4s, 10000 Zagreb, Hrvatska
+385 1 798 8089



GTV Czech Distribution s.r.o.
CTPark Ostrava, Na Rovince 879, 720 00 Ostrava Hrabová
+420 591 160 091



GTV España Herrajes, E Iluminación, S.L.,
Avenida Aragón 308, 46021 Valencia, Spain
+34 960 468 666

www.hoegert.com

Follow us on:

