

(DE) / (EN) / (FR) / (ES) / (HR) / (HU) / (RO) / (BG)

2022/2023





## Werkzeuge für Anspruchsvolle

Wir bieten wertvolle Lösungen, die Langlebigkeit und Funktionalität miteinander verbinden. Unsere Produkte sind für anspruchsvolle Anwender und intensive Nutzung konzipiert. Die Marke Högert Technik richtet sich an Profis, die bei ihrer täglichen Arbeit Handwerkzeuge einsetzen.

### Kundenzufriedenheit ist unsere Priorität. Wir garantieren:

- Hilfe bei der Produktauswahl;
- Schnelle Ausführung von Bestellungen;
- Effiziente Logistik;
- Umfassende Marketingunterstützung.



### ERWEITERTE GARANTIE

Wir bieten eine lebenslange oder 25-jährige Garantie für ausgewählte Werkzeugsets und Produkte von Högert Technik. Die Garantie gilt innerhalb der Europäischen Union und bezieht sich auf die während der Garantiezeit offenbaren Fertigungs- und Materialfehler.

### QUALITÄTSKONTROLLE

Högert Technik Produkte erfüllen die wichtigsten Qualitätsstandards.

Qualität ist das höchste Maß der Marke Högert Technik. Unsere Produkte werden vor dem Verkauf einer Reihe von Tests und externen Audits unterzogen. Wir sind ständig auf der Suche nach neuen Lösungen, die unseren Kunden die Arbeit erleichtern – und um die Messlatte nicht nur für uns, sondern auch für unsere Wettbewerber höher zu legen.



### DER MOBILE DEMO-WAGEN

Die multifunktionale Markenplattform bietet kostenlose Präsentationen und Schulungen zum Werkzeugsortiment von Högert Technik: Shows, Produkttests, Wettbewerbe mit Preisen.

### B2B PLATTFORM FÜR VERTRIEBSHÄNDLER

Bietet schnelles und intuitives Einkaufen und vollen Zugriff auf das Produktangebot 24 Stunden am Tag, 7 Tage die Woche, ohne geographische Einschränkungen.

Über die B2B-Plattform bieten wir Zugang zu: aktuelle Preise und Lagerbestände, Produktfotos, Datenblätter und detaillierte Produktinformationen, Status der Auftragsabwicklung und Handelsunterlagen.

### API - AUTOMATISIERTER DATENAUSTAUSCH

Um die Arbeit unserer Geschäftspartner effizienter zu gestalten, bieten wir die Integration von Shops und Websites mit der zentralen Högert Technik Produktdatenbank an.

### Social Media – Bleiben Sie auf dem Laufenden!

Unsere Aktivität auf den Plattformen Facebook und YouTube umfasst aktuelle Informationen über das Leben der Marke sowie Produktneuheiten, Tipps und Präsentationen ausgewählter Produkte aus dem Angebot.



### INFLUENCER MARKETING und SPORT-MARKETING

Wir arbeiten daran, die Marke Högert Technik im In- und Ausland bekannt zu machen, unter anderem durch die Zusammenarbeit mit Influencern oder Sponsoring von Sportwettbewerben.

### SOZIALE VERANTWORTUNG

Seit dem Beginn unserer Tätigkeit haben wir die Notwendigkeit erkannt, technische Berufe zu fördern und lokale Organisationen zu unterstützen. Deshalb beteiligen wir uns an Veranstaltungen, die profilierte Schulen fördern und über den Stellenmarkt für spezialisierte Branchen informieren. Wir unterstützen Organisationen, indem wir Werkzeuge bereitstellen, die ihre tägliche Arbeit erleichtern.

### PRODUKTKATEGORIEN

Das Portfolio der Marke wird ständig erweitert. Als Reaktion auf die Marktnachfrage und die Bedürfnisse unserer Kunden legen wir besonderen Wert auf die Entwicklung von allen Produktkategorien.

- MECHANISCHE WERKZEUGE
- DRUCKLUFT-WERKZEUGE
- KFZ-WERKZEUGE
- WERKSTATTWERKZEUGE
- WERKZEUGE FÜR ELEKTRIKER
- WERKZEUGE FÜR KLEMPNER
- BAUWERKZEUGE
- MESSGERÄTE
- ZUBEHÖR FÜR ELEKTROGERÄTE
- ANSCHLUSSWERKZEUGE
- ELEKTROWERKZEUGE
- ZUBEHÖR FÜR WERKZEUGKASTEN

Wir laden Sie ein, sich mit dem HÖGERT WORKWEAR Sortiment vertraut zu machen. Die Kollektionen für Arbeitsschutz- und Sicherheitskleidung, Schuhe und Zubehör sind Produkte, die sich gegenseitig ergänzen und für einen angemessenen Körperschutz unerlässlich sind.



## Hand tools of the most demanding users

We provide valuable solutions, combining durability and functionality. Our products are created for demanding users and intensive use. The Högert Technik brand offer is addressed to professionals who use hand tools in their daily work.

### Customer satisfaction is our priority. We guarantee:

- Assistance in choosing an assortment;
- Fast execution of orders;
- Efficient logistics;
- Full marketing support.



### EXTENDED WARRANTY

We provide a 25-year or lifetime warranty for selected Högert Technik tool kits and products. The warranty is valid in the European Union and covers manufacturing and material defects revealed during the warranty period.

### QUALITY CONTROL

Högert Technik products meet the most important quality standards.

Quality is the superior value of the Högert Technik brand. Our products go through a series of tests and external audits before they go on sale. We are constantly looking for new solutions that make work easier for users – raising the bar for ourselves and the competition.



### DEMO-CAR – A MOBILE SHOWROOM

The multifunctional brand platform provides free presentations and training on the Högert Technik tool range: shows, product tests, tips, contests with prizes.

### B2B PLATFORM FOR DISTRIBUTORS

Allows fast and intuitive shopping and full access to the product offer 24 hours a day, 7 days a week, without geographical restrictions.

Through the B2B platform, we provide access to current prices and inventory, product photos, data sheets and detailed information about the products, order fulfilment status and commercial documents.

### API - automated data exchange

In order to improve the work of our business partners, we provide the integration of stores and websites with the central database of Högert Technik products.

### Social Media - Always be up to date!

Our activity on Facebook and YouTube includes current information about the brand's life, as well as about new products, advice and presentations of selected products from the product range.



### INFLUENCER MARKETING and SPORTS MARKETING

We strive to make the Högert Technik brand recognizable on the domestic and international markets, e.g. through the cooperation with influencers or sports games sponsorship.

### SOCIAL RESPONSIBILITY

From the beginning of our activity, we assume the need to promote technical competitions and support local organizations.

This is why we are involved in events that promote specialized schools, the purpose of which is to inform about the labour market for specialized industries. We support leading nationwide competitions for young professionals and numerous educational fairs. We support organizations that work for the benefit of society, by providing tools that make their daily functioning easier.

### PRODUCT CATEGORIES

The brand's portfolio is constantly expanding every year. In response to the market needs and our clients, we put special emphasis on the development of each category.

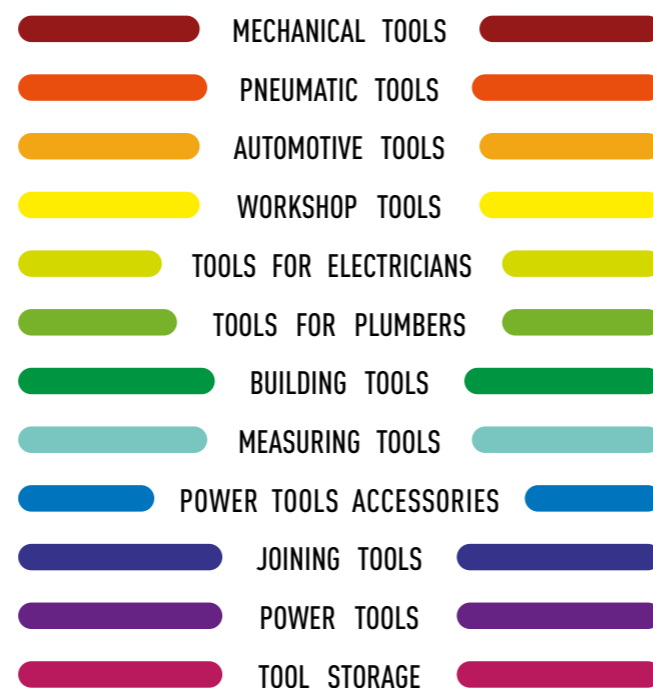

We encourage you to look at the HÖGERT WORKWEAR offer. Collections of footwear and OHS accessories are complementary products that are necessary for the proper protection of the body.



## Hand tools of the most demanding users

Nous fournissons des solutions à valeur ajoutée alliant durabilité et fonctionnalité. Nos produits sont conçus pour des utilisateurs exigeants et un usage intensif. L'offre de la marque Högert Technik est principalement adressée aux professionnels, aux personnes qui utilisent professionnellement l'outillage à main dans leur travail quotidien.

### La satisfaction client est une priorité pour nous. Nous garantissons:

- Assistance pour le choix des assortiments de produits;
- Réalisation rapide des commandes;
- Logistique efficace;
- Support marketing complet.



### ALLONGEMENT DE LA PÉRIODE DE GARANTIE

Nous offrons une garantie à vie ou de 25 ans sur certains ensembles d'outils et produits Högert Technik. La garantie est valable dans l'Union européenne et couvre les défauts de fabrication et de matériaux révélés pendant la période de garantie.

### CONTRÔLE DE LA QUALITÉ

Les produits Högert Technik répondent aux normes de qualité les plus importantes.

La qualité est une valeur fondamentale de la marque Högert Technik. Nos produits subissent une série de tests et de contrôles externes avant leur mise en vente. Nous sommes constamment à la recherche de nouvelles solutions pour faciliter le travail des utilisateurs de nos outils – ce qui nous permet de nous surpasser nous-mêmes ainsi que nos concurrents.



### PLATE-FORME D'EXPOSITION MOBILE

La plate-forme de marque multifonctionnelle propose des présentations et des formations gratuites sur l'offre d'outils Högert Technik: présentations, tests de produits, conseils, concours avec prix.

### PLATEFORME B2B POUR LES DISTRIBUTEURS

Il permet des achats rapides et intuitifs ainsi qu'un accès complet à l'offre des produits 24 h / 24 h, 7 j / 7 j, sans aucune restriction géographique.

A travers la plateforme B2B nous assurons l'accès aux: prix courants et inventaires, photos des produits, fiches de catalogue et informations détaillées sur les produits, état d'exécution des commandes et documents commerciaux.

### API - échange de données automatisé

Afin d'améliorer le travail de nos partenaires commerciaux, nous assurons l'intégration des magasins et des sites Internet avec la base de données centrale des produits Högert Technik.

### SOCIAL MEDIA – Soyez toujours au courant!

Notre activité dans les réseaux sociaux Facebook et YouTube comprend des informations actuelles sur la vie de la marque, sur les nouveaux produits, ainsi que des conseils et des présentations de produits sélectionnés dans l'offre.



### INFLUENCER MARKETING et MARKETING SPORTIF

Nous travaillons à rendre la marque Högert Technik reconnaissable sur le marché national et à l'étranger, en coopérant entre autres avec des suiveurs ou sponsorisant des jeux sportifs.

### RESPONSABILITÉ SOCIALE

Dès le début de notre activité nous voyons la nécessité de promouvoir les professions techniques et de supporter les organisations locales.

C'est pourquoi nous voyons engagés dans des événements qui promeuvent les écoles professionnelles et qui mettent au courant le public sur le marché de travail pour les secteurs spécialisés. Nous supportons les concours nationaux pour les jeunes techniciens et menuisiers en de technologie de bois ainsi que de nombreux autres événements éducatifs. Nous soutenons aussi les organisations qui travaillent pour le bien de la société, en leur fournissant des outils qui facilitent leur travail quotidien.

### CATÉGORIES DE PRODUITS

Le portfolio de la marque est constamment élargie. En répondant aux besoins du marché et de nos clients, nous accordons une importance particulière au développement constant au sein de chaque catégorie.



Nous vous invitons à découvrir l'offre de HÖGERT WORKWEAR. Les collections de vêtements et d'accessoires de santé et de sécurité ce sont des produits complémentaires nécessaires pour assurer une bonne protection du corps.



## Hand tools of the most demanding users

Aportamos soluciones valiosas que combinan durabilidad y funcionalidad. Nuestros productos están diseñados para usuarios exigentes y un uso intensivo. La oferta de la marca Högert Technik se dirige a profesionales que utilizan herramientas manuales en su trabajo diario.

### Satisfacción de los clientes es nuestra prioridad. Garantizamos:

- Asistencia en la elección de productos;
- Rapidez en la ejecución de los pedidos;
- Logística eficaz;
- Completo apoyo comercial.



### GARANTÍA AMPLIADA

Ofrecemos una garantía de 25 años o de por vida para los juegos de herramientas y productos seleccionados de Högert Technik. La garantía es válida dentro de la Unión Europea y cubre los defectos de fabricación y de los materiales revelados durante el periodo de garantía.

### CONTROL DE CALIDAD

Los productos de Högert Technik cumplen las más importantes normas de calidad. La calidad es el valor más destacado de nuestra marca. Nuestros productos pasan por una serie de pruebas e inspecciones externas antes de salir a la venta. Buscamos constantemente nuevas soluciones para facilitar el trabajo de los usuarios de las herramientas, elevando el listón para nosotros mismos y para la competencia.



### DEMO-CAR COCHE DE DEMOSTRACIÓN

La plataforma multifuncional de la marca ofrece presentaciones y formación gratuitas sobre la gama de herramientas de Högert Technik: demostraciones, pruebas de productos, asesoramiento, concursos con premios.

### PLATAFORMA B2B PARA DISTRIBUIDORES

Proporciona una experiencia de compra rápida e intuitiva y un acceso completo a la oferta de productos 24 horas al día, 7 días a la semana y sin limitaciones geográficas.

A través de la plataforma B2B proporcionamos acceso a precios e inventarios actuales, fotos de productos, fichas técnicas e información detallada sobre los mismos, estado de realización de pedidos y documentos comerciales.

### API - INTERCAMBIO DE DATOS AUTOMATIZADO

Para hacer más eficaz el trabajo de nuestros socios comerciales, ofrecemos la integración de tiendas y páginas web con la base de datos central de productos de Högert Technik.

### REDES SOCIALES – mantente siempre al día!

Nuestra actividad en las plataformas de Facebook e YouTube incluye información actualizada sobre la vida de la marca, así como noticias de productos, consejos y presentaciones de productos seleccionados de la gama.



### MARKETING DE INFLUENCER Y MARKETING DEPORTIVO

Trabajamos para que la marca Högert Technik sea reconocible tanto en el mercado nacional como en el extranjero, entre otras cosas, colaborando con influencers o patrocinando competiciones deportivas.

### RESPONSABILIDAD SOCIAL

Desde el inicio de nuestra actividad hemos reconocido la necesidad de promover las profesiones técnicas y de apoyar a las organizaciones locales.

Por ello, participamos en eventos que promueven las escuelas técnicas especializadas e informan sobre el mercado laboral de las industrias especializadas. Apoyamos grandes concursos nacionales para jóvenes profesionales y numerosas ferias educativas. Apoyamos a las organizaciones que prestan sus servicios a la comunidad obsequiándoles con herramientas que facilitan sus tareas diarias.

### CATEGORÍAS DE PRODUCTOS

La oferta de productos se amplía constantemente de año en año. En respuesta a las demandas del mercado y a las necesidades de nuestros clientes, ponemos especial énfasis en el desarrollo constante dentro de cada categoría.



Échale un vistazo a la oferta de HÖGERT WORKWEAR. Las colecciones de ropa, calzado y accesorios EPI son productos complementarios e imprescindibles para una correcta protección corporal.



## Hand tools of the most demanding users

Pružamo vrijedna rješenja, kombinirajući trajnost i funkcionalnost. Naši proizvodi izrađeni su s mišlju o zahtjevnim korisnicima i za intenzivnu upotrebu. Ponuda robne marke Högert Technik upućena je profesionalcima, ljudima koji koriste ručne alate u svakodnevnom radu.

### Zadovoljstvo kupaca je naš prioritet. Jamčimo:

- Pomoć u odabiru asortimana;
- Brzu realizaciju narudžbi;
- Učinkovitu logistiku;
- Potpunu marketinška podršku.



### PRODULJENO JAMSTVO

Dajemo 25 godina ili doživotno jamstvo za odabrane Högert Technik alate i proizvode. Jamstvo vrijedi na teritoriju Europske unije i pokriva proizvodne i materijalne nedostatke otkrivene tijekom jamstvenog razdoblja.

### KONTROLA KVALITETE

Proizvodi Högert Technik odgovaraju najvažnijim standardima kvalitete.

Kvaliteta je glavna vrijednost naše marke. Naši proizvodi prolaze kroz niz vanjskih ispitivanja i kontrola prije nego što se stave u ponudu. Stalno tražimo nova rješenja koja će olakšati rad korisnicima alata - podižući ljestvicu za sebe i konkurenciju.



### DEMO-CAR MOBILNI SHOWROOM

Multifunkcionalna platforma marke nudi besplatne prezentacije i edukacije o ponudi alata Högert Technik: prezentacije, tesiranje proizvoda, savjeti, nagradne igre.

### B2B PLATFORMA ZA DISTRIBUTERE

Omogućuje brzu i intuitivnu kupnju i puni pristup ponudi proizvoda 24 sata dnevno, 7 dana u tjednu, bez ograničenja. Putem B2B platforme pružamo pristup trenutnim cijenama i zalihama, fotografijama proizvoda, kataloškim karticama i detaljnim informacijama o proizvodima, statusu realizacije narudžbe i prodajnim dokumentima.

### API - AUTOMATSKA RAZMJENA PODATAKA

Kako bismo poboljšali rad naših poslovnih partnera, pružamo integraciju trgovina i web stranica s centralnom bazom podataka o proizvodima Högert Technik.

### SOCIAL MEDIA - Uvijek budite u toku!

Naše aktivnosti na Facebook i YouTube platformama uključuju trenutne informacije iz života marke, kao i vijesti o proizvodima, savjete i prezentacije odabranih proizvoda iz ponude.



### INFLUENCER MARKETING I SPORTSKI MARKETING

Radimo na tome da marka Högert Technik postane prepoznatljiva na domaćem tržištu i u inozemstvu. Suradujemo s influencerima, sponzoriramo sportske igre.

### SOCIJALNA ODGOVORNOST

Od početka naše djelatnosti vidimo potrebu promicanja tehničkih zanata i podrške lokalnim organizacijama.

Zbog toga smo uključeni u događaje koji promoviraju specijalizirane škole i informiraju o tržištu rada za specijalizirane industrije. Podržavamo vodeća državna natjecanja za mlade stručnjake i brojne edukativne sajmove. Podržavamo organizacije koje rade na dobrobit društva dajući njima na korištenje alate koji olakšavaju njihov svakodnevni rad.

### KATEGORIJE PROIZVODA

Portfelj marke se neprestano proširuje iz godine u godinu. Kao odgovor na potražnju na tržištu i potrebe naših kupaca, poseban naglasak stavljamo na stalni razvoj unutar svake kategorije.



Molimo upoznajte se s ponudom HÖGERT WORKWEAR. Kolekcije odjeće, obuće i dodatka za zaštitu na radu – proizvodi se međusobno nadopunjuju i neophodni su za pravilnu zaštitu tijela na radu.



## Hand tools of the most demanding users

Értékes, tartósságot és funkcionalitást ötvöző megoldásokat biztosítunk. Termékeinket a legigényesebb felhasználók számára, intenzív használatot szem előtt tartva tervezzük. A Högert Technik márka termékei a mindennapi munkájuk során kézi szerszámokat használó szakembereknek készültek.

### A mi prioritásunk az elégedett ügyfél. Garantáljuk:

- Termék kiválasztásában nyújtott segítség;
- Megrendelések gyors megvalósítása;
- Hatékony logisztika;
- Teljes körű marketingtámogatás.

### MEGHOSSZABBÍTOTT GARANCIA

Élettartam vagy 25 év garanciát biztosítunk az egyes szerszámkészletekre és Högert Technik termékekre. A garancia az egész Európai Unió területén érvényes és a garancia időtartama alatt jelentkező gyártási hibákra és anyaghibákra vonatkozik.



### MINŐSÉGELENŐRZÉS

A Högert Technik termékek a legmagasabb minőségi elvárásoknak felelnek meg.

A minőség a Högert Technik márka egyik alapértéke. Termékeink számos vizsgálaton és külső ellenőrzésen esnek át azelőtt, hogy értékesítésre kerüljenek. Szüntelenül olyan új megoldásokat keresünk, melyek megkönnyítik a szerszám felhasználójának munkáját - ezáltal magasabbra helyezve a léccet számunkra és a konkurencia számára.



### DEMO-CAR – MOBIL SHOWROOM

Multifunkciós platform ingyenes prezentációt és oktatást tesz lehetővé a Högert Technik kínálatával kapcsolatban: prezentációk, termékeszettek, tippek, nyereményjátékok.

### B2B DISZTRIBÚTORI PLATFORM

Lehetővé teszi termékeink gyors és intuitív megvásárlását és teljes hozzáférést biztosít a kínálatunkhoz a nap 24 órájában, földrajzi korlátozások nélkül.

A B2B platformon keresztül a következő információkhoz biztosítunk hozzáférést: aktuális árak és raktárkészlet, termékfotók, termékadatok és részletes termékinformációk, a megrendelés teljesítésének státusza és kereskedelmi dokumentumok.

### API - automatizált adatcsere

Üzleti partnereink munkájának javítása érdekében hozzáférést biztosítunk a webáruházak és weboldalak részére a Högert Technik cég központi termékadatbázisához.

### KÖZÖSSÉGI MÉDIA - Legyél naprakész!

A márkával kapcsolatos naprakész információkkal, valamint az új termékeinkkel és egyes termékekkel kapcsolatos tanácsokkal és bemutatókkal szolgálunk a Facebook és YouTube platformokon.



### INFLUENCER MARKETING és SPORT MARKETING

Jelentős erőfeszítéseket teszünk azért, hogy a hazai piacon és külföldön is felismerhetővé tegyük a Högert Technik márkát, többek között influencerekkel együttműködve vagy sportversenyek szponzorálásával.

### TÁRSADALMI FELELŐSÉGVÁLLALÁS

Üzleti tevékenységünk kezdete óta tisztában vagyunk a műszaki szakmák népszerűsítésének és a helyi szervezetek támogatásának fontosságával. Ezért számos olyan rendezvényen részt veszünk, amelyek népszerűsítik a szakpariskolákat, és tájékoztatnak a szakosodott iparágak munkaerőpiacáról. Támogatjuk azokat a legfontosabb országos versenyeket amelyeket fiatal szakemberek számára rendeznek, valamint egyéb oktatási eseményeket. Segítünk számos önkéntes szervezetet, mint például az Önkéntes Tűzoltókat, ezzel is megkönnyítve a mindennapi működésüket.

### TERMÉKKATEGÓRIÁK

A márka kínálata évről évre bővül. Vásárlóink és a piac igényeire reagálva különös hangsúlyt fektetünk az egyes kategóriákon belüli folyamatos fejlődés érdekében.



Szíves figyelmükbe ajánljuk a HÖGERT WORKWEAR termékkínálatát. A munkavédelmi ruházat, lábbeli- és tartozék kollektívák olyan kiegészítő termékek, amelyek elengedhetetlenek a test megfelelő védelméhez.



## Hand tools of the most demanding users

Oferim soluții valoroase, combinând durabilitatea și funcționalitatea. Produsele noastre sunt create pentru utilizatorii exigenți și folosință intensă. Oferta mărcii Högert Technik se adresează profesioniștilor, persoanelor care folosesc în munca lor profesională de zi cu zi unelte de mână.

### Prioritatea noastră este satisfacția clientului. Garantăm:

- Asistență în selectarea sortimentului;
- Realizare rapidă a comenzilor;
- Logistică eficientă;
- Suport complet de marketing.



### GARANȚIE PRELUNGITĂ

Oferim o garanție pe viață sau de 25 de ani pentru trusele și produsele Högert Technik selectate. Garanția este valabilă în Uniunea Europeană și acoperă defectele de fabricație și a materialelor detectate în perioada de garanție.

### CONTROLUL CALITĂȚII

Produsele Högert Technik îndeplinesc cele mai importante standarde de calitate. Calitatea reprezintă valoarea superioară a brandului Högert Technik. Produsele noastre trec printr-o serie de teste și controale externe înainte de a intra în vânzare. Căutăm în mod constant soluții noi care să ușureze munca utilizatorilor - ridicând ștacheta atât pentru noi înșine cât și pentru concurență.



### DEMO CAR - UN SHOWROOM MOBIL

Platforma de brand multifuncțională oferă prezentări gratuite și instruire cu privire la oferta de unelte Högert Technik: prezențații, teste de produs, sfaturi, concursuri cu premii.

### PLATAFORMA B2B PENTRU DISTRIBUITORI

Oferă comenzi rapide și intuitive, acces complet la oferta de produse 24/24, 7 zile pe săptămână, fără restricții geografice.

Prin intermediul platformei B2B, oferim acces la: prețuri curente și stocuri; fotografii de produse, fișe tehnice și informații detaliate despre produse; statutul de implementare a comenzilor și documente comerciale.

### API - schimb automat de date

Pentru a îmbunătăți activitatea partenerilor noștri de afaceri, oferim integrarea magazinelor și a site-urilor web cu baza de date centrală a produselor Högert Technik.

### REȚELE SOCIALE - Fii mereu la curent!

Activitatea noastră pe platformele Facebook și YouTube includ informații actuale despre viața mărcii, precum și despre produse noi, precum și sfaturi și prezentări ale produselor selectate din ofertă.



### INFLUENCER MARKETING și MARKETING SPORTIV

Lucrăm pentru ca marca Högert Technik să fie recunoscută pe piața internă și în străinătate, printru altele, cooperând cu influențatori sau sponsorizând jocuri sportive.

### RESPONSABILITATE SOCIALĂ

De la începutul activității noastre, vedem necesitatea de a promova competițiile tehnice și a sprijini organizațiile locale. De aceea, ne angajăm în evenimente care promovează școlile de profil și informează despre piața muncii pentru industriile specializate. Susținem competiții la nivel național pentru tineri tehnicieni în tehnologia lemnelui și tâmplari și numeroase târguri educaționale. Susținem organizațiile care lucrează în beneficiul societății oferind instrumente care le ușurează funcționarea zilnică.

### CATEGORII DE PRODUSE

Portofoliul brandului este în mod constant extins din an în an. Ca răspuns la nevoile pieței și ale clienților noștri, punem un accent deosebit pentru dezvoltare constantă în cadrul fiecărei categorii.

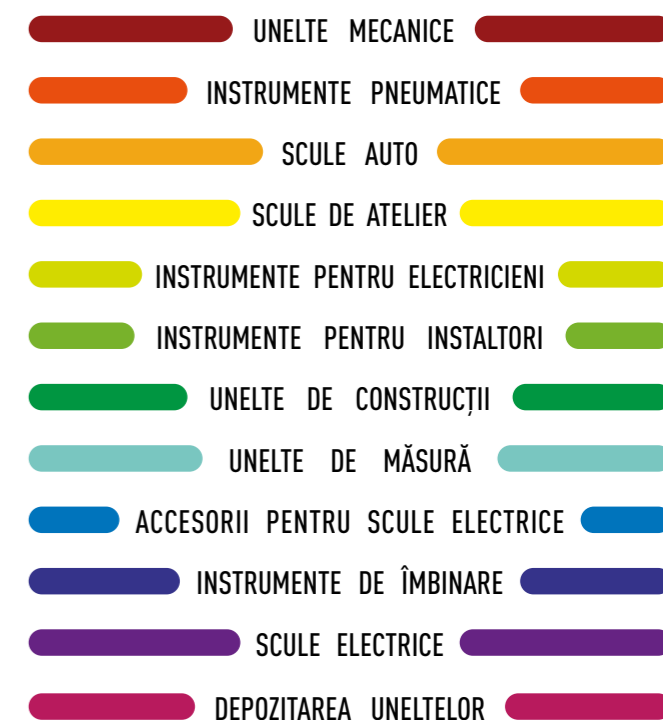

Vă încurajăm să vă familiarizați cu oferta HÖGERT WORKWEAR. Colecțiile de îmbrăcăminte, încălțăminte și accesorii pentru securitate și sănătate în muncă - SSM sunt produse complementare care sunt esențiale pentru o protecție adecvată a corpului.





**Hand tools of the most demanding users**

Ние предлагаме ценни решения, съчетаващи издръжливост и функционалност.

Нашите продукти са проектирани за вискателни потребители и интензивна употреба. Офертата на марката Högert Technik е адресирана до професионалисти, хора, които професионално използват ръчни инструменти в ежедневноста си работа.

**Удовлетворението на клиентите е наш приоритет. Гарантираме:**

- Помощ при избора на асортимент;
- Бързо изпълнение на поръчки;
- Ефективна логистика;
- Пълна маркетингова поддръжка.



### РАЗШИРЕНА ГАРАНЦИЯ

Ние предоставяме 25-годишна или доживотна гаранция за избрани комплекти инструменти и продукти на Högert Technik. Гаранцията е валидна в Европейския съюз и обхваща производствени и материални дефекти, разкрити по време на гаранционния период.

### КОНТРОЛ НА КАЧЕСТВОТО

Продуктите на Högert Technik отговарят на най-важните стандарти за качество.

Качеството е най-важната стойност на нашата марка. Нашите продукти преминават поредица от външни тестове и проверки, преди да бъдат продадени. Ние непрекъснато търсим нови решения, които да улеснят работата на потребителите на инструменти - повдигане на летвата за нас и конкуренцията.

### АВТОМОБИЛЕН SHOWROOM

Мултифункционалната платформа на марката предлага безплатни презентации и обучения относно предлаганите инструменти на Högert Technik: шоу, тестове на продукти, съвети, състезания с награди.

### В2В ПЛАТФОРМА ЗА ДИСТРИБУТОРИ

Тя осигурява бързо и интуитивно пазаруване и пълен достъп до продуктова оферта 24 часа в денонощието, 7 дни в седмицата, без географски ограничения.

Чрез В2В платформата ние предоставяме достъп до текущи цени и инвентар, снимки на продукти, каталожни карти и подробна информация за продуктите, както и състоянието на изпълнение на поръчките и търговски документи.

### API - автоматизиран обмен на данни

За да подобрим работата на нашите бизнес партньори, ние осигуряваме интегрирането на магазини и уебсайтове с централната база данни с продуктите на Högert Technik.

### SOCIAL MEDIA - БЪДЕТЕ В ЧАС

Нашата дейност във Facebook и YouTube платформи включва актуална информация за марката, нови продукти, както и съвети и презентации на избрани продукти от офертата.



### INFLUENCER МАРКЕТИНГ и СПОРТЕН МАРКЕТИНГ

Работим, за да направим марката Högert Technik разпознаваема на вътрешния пазар и в чужбина, затова сътрудничим с влиятелни лица или сме спонсор на спортни игри.

### СОЦИАЛНА ОТГОВОРНОСТ

От началото на нашата дейност виждаме необходимостта от насърчаване на техническите професии и подкрепа на местните организации. Защото участваме в събития, които популяризират технически училища и подкрепяме пазара на труда. Спонсорираме водещи национални състезания за млади специалисти и множество образователни панаири. Ние подкрепяме организациите, работещи в полза на обществото, като предоставяме инструменти, които улесняват ежедневно им функциониране.

### ПРОДУКТОВИ КАТЕГОРИИ

Портфолиото на марката постоянно се разширява. В отговор на нужди на пазара и нашите клиенти, ние поставяме особен акцент върху постоянното развитие във всяка категория.

- МЕХАНИЧНИ ИНСТРУМЕНТИ
- ПНЕВМАТИЧНИ ИНСТРУМЕНТИ
- АВТОМОБИЛНИ ИНСТРУМЕНТИ
- РАБОТНИ ИНСТРУМЕНТИ
- ИНСТРУМЕНТИ ЗА ЕЛЕКТРОТЕХНИЦИ
- ИНСТРУМЕНТИ ЗА ВОДОПРОВОДЧИК
- СТРОИТЕЛНИ ИНСТРУМЕНТИ
- ИЗМЕРВАЩИ ИНСТРУМЕНТИ
- АКСЕСОАРИ ЗА ЕЛЕКТРОИНСТРУМЕНТИ
- СВЪРЗВАЩИ ИНСТРУМЕНТИ
- ЕЛЕКТРИЧЕСКИ ИНСТРУМЕНТИ
- СЪХРАЯВАНЕ НА ИНСТРУМЕНТИ

Препоръчваме Ви да се запознаете с офертата на HÖGERT WORKWEAR. Предлагаме дрехи и обувки за работа и защита на тялото. В нашата оферта предлагаме аксесоари, които са част и необходимост за защита на тялото и безопасността на работното Ви място.



**DE** Mechanische Werkzeuge **EN** Mechanical Tools **FR** Outils Mécaniques **ES** Herramientas Mecánicas **HR** Mehanički Alati  
**HU** Mechanikus Szerszámok **RO** Unelte Mecanice **BG** Механични Инструменти

 HT1R490 48	 HT1R478 48	 HT1R492 48	 HT1R410 49	 HT1R480 49
 HT1R464 49	 HT1R491 50	 HT1R465 50	 HT1R466 50	 HT1R462 51
 HT1S405 51	 HT1S404 51	 HT1R439 53	 HT1R416 54	 HT1R485 54
 HT1R470 55	 HT1R486 55	 HT1R425 56	 HT1R424 56	 HT1R426 57
 HT1R432 57	 HT1R440 58	 HT1R444 59	 HT1R332 60	 HT1R334 60
 HT1R382 60	 HT1R395 60	 HT1R374 60	 HT1R304 60	 HT1R324 60

 HT1R354 60	 HT1R342 62	 HT1R391 62	 HT1W701 62	 HT1W710 62
 HT1W879 62	 HT1S203 62	 HT1A701 62	 HT1A714 62	 HT1A724 63
 HT1A740 63	 HT1A792 63	 HT1A745 63	 HT1A763 63	 HT1A755 63
 HT1A770 63	 HT1A002 63	 HT1A156 64	 HT1A208 64	 HT1A258 64
 HT1A408 64	 HT1A779 65	 HT1A783 65	 HT1A886 65	 HT1A888 65
 HT1A884 65	 HT1A880 65	 HT1A752 65	 HT1S601 65	 HT1S606 66
 HT1S623 66	 HT1S640 66	 HT1S670 66	 HT1S724 66	 HT1S746 66







HT1S272 76



HT1S270 76



HT1S271 76



HT1S094 76



HT1S095 77

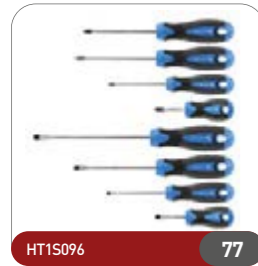

HT1S096 77



HT1S097 77



HT1S098 77



HT1S100 77



HT1S101 77



HT1S215 77



HT1S216 77



HT1S105 78



HT1S099 78



HT1S214 80



HT1S201 80



HT1S001 80



HT1S020 80



HT1S040 80



HT1S051 80



HT1S064 80

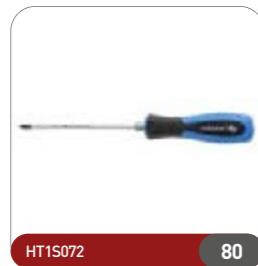

HT1S072 80



HT1S077 81



HT1S986 81

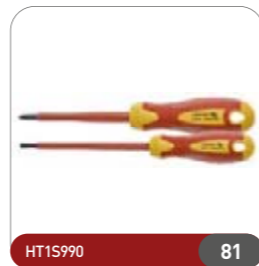

HT1S990 81

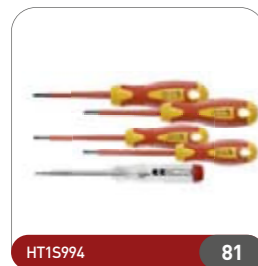

HT1S994 81

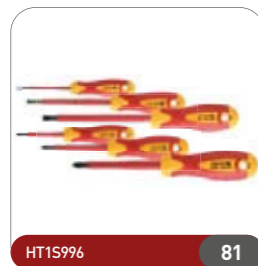

HT1S996 81

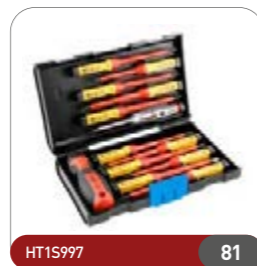

HT1S997 81

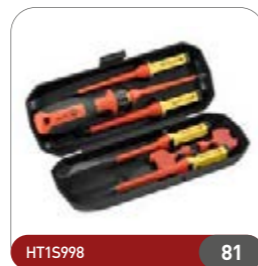

HT1S998 81



HT1S902 81



HT1S960 82



HT1S920 82

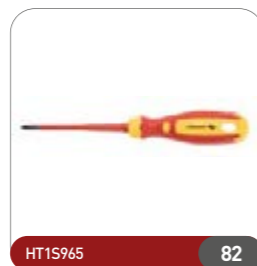

HT1S965 82



HT1S940 82



HT1S968 82



HT1S973 82



HT1W730 82



HT1W590 82



HT1W599 83

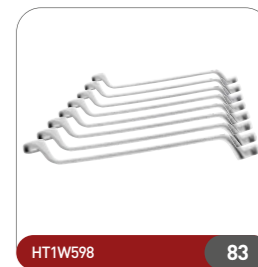

HT1W598 83



HT1W492 83



HT1W496 83



HT1W406 83

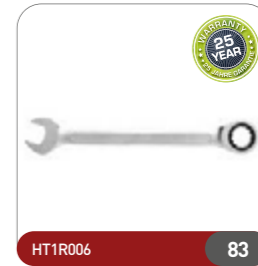

HT1R006 83



HT1R048 85

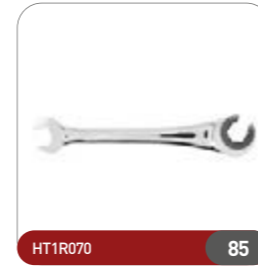

HT1R070 85

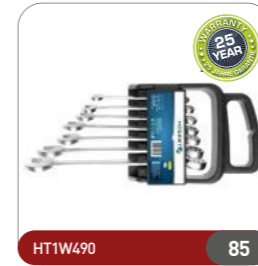

HT1W490 85

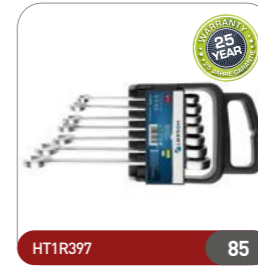

HT1R397 85



HT1P006 85



HT1P010 85



HT1P016 85



HT1P022 86



HT1P026 86



HT1P050 86



HT1P052 86



HT1P054 86



HT1P056 86



HT1P058 86

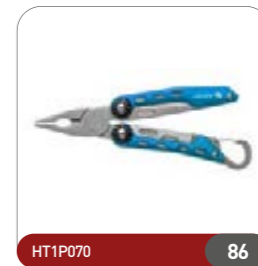

HT1P070 86

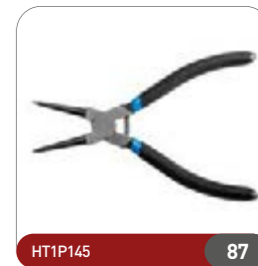

HT1P145 87

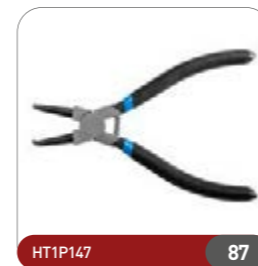

HT1P147 87



HT1P146 87



HT1P148 87

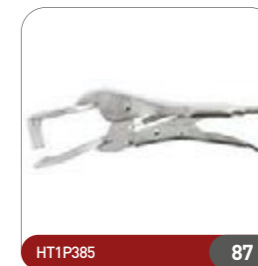

HT1P385 87



HT1P386 87

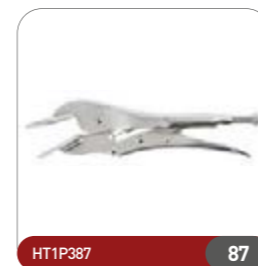

HT1P387 87



HT3B617 87

**DE** Druckluft-Werkzeuge **EN** Pneumatic Tools **FR** Outils Pneumatiques **ES** Herramientas Neumáticas **HR** Pneumatski Alati  
**HU** Pneumatikus Szerszámok **RO** Instrumente Pneumatice **BG** Пневматични Инструменти

 HT4R621 90	 HT4R622 90	 HT4R623 90	 HT4R625 90	 HT4R626 90
 HT4R630 90	 HT4R650 90	 HT4R635 90	 HT4R651 91	 HT4R652 91
 HT4R060 91	 HT4R010 91	 HT4R006 91	 HT4R104 91	 HT4R049 91
 HT4R141 91	 HT4R111 92	 HT4R211 92	 HT4R302 92	 HT4R315 92
 HT4R320 92	 HT4R324 92	 HT4R326 92	 HT4R328 92	 HT6R002 93
 HT6R004 93	 HT6R006 93	 HT4R712 93	 HT4R718 93	 HT4R716 93

 HT4R746 93	 HT4R748 93	 HT4R750 94	 HT4R751 94	 HT4R755 94
 HT4R757 94	 HT4R758 94	 HT4R801 94	 HT4R810 94	 HT4R820 94
 HT4R821 95	 HT4R870 95	 HT4R871 95	 HT4R873 95	 HT4R874 95
 HT4R875 95	 HT4R876 95	 HT4R890 95		

**DE** KFZ-Werkzeuge **EN** Automotive Tools **FR** Outils Automobiles **ES** Herramientas De Automoción **HR** Alati Za Automobile  
**HU** Járműipari Szerszámok **RO** Scule Auto **BG** Автомобилни Инструменти

 HT8G004 98	 HT8G006 98	 HT8G022 98	 HT8G052 98	 HT8G100 98
 HT8G310 98	 HT8G311 98	 HT8G314 98	 HT8G317 99	 HT8G318 99



HT8G315 99

HT8G348 99

HT8G372 99

HT8G374 99

HT4R780 99

HT8G323 104

HT8G324 104

HT8G325 104

HT8G326 106

HT8G301 106

HT8G376 99

HT8G373 100

HT8G371 100

HT8G375 100

HT8G370 100

HT8G305 106

HT8G321 106

HT8G306 106

HT8G307 106

HT8G328 107

HT8G433 100

HT8G434 100

HT8G245 100

HT8G246 100

HT8G247 102

HT8G329 107

HT8G360 107

HT8G361 107

HT8G362 107

HT8G364 107

HT8G248 102

HT8G200 102

HT8G215 102

HT8G210 102

HT8G205 102

HT8G363 107

HT8G420 107

HT8G252 108

HT8G432 108

HT8G327 108

HT8G254 102

HT8G257 102

HT8G218 103

HT8G251 103

HT4R781 103

HT8G330 108

HT8G423 108

HT8G320 108

HT2E200 108

HT8G430 108

HT8G225 103

HT8G231 103

HT8G230 103

HT8G240 103

HT8G250 103

HT8G410 109

HT8G411 109

HT8G412 109

HT8G413 109

HT8G414 109

HT8G258 104

HT8G253 104

HT8G322 104

HT8G227 104

HT8G229 104

HT8G415 109

HT8G416 109

HT8G418 109

HT8G421 110

HT8G400 110



HT8G401 110



HT8G402 110



HT8G403 110



HT8G404 110



HT8G405 110



HT8G406 110



HT8G407 111



HT8G408 111



HT8G409 111



HT8G394 111



HT8G393 111



HT8G390 111



HT8G391 111



HT8G392 111

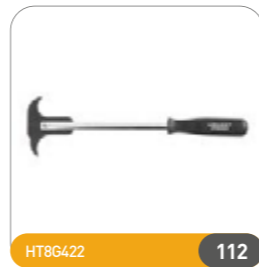

HT8G422 112



HT8G427 112



HT8G440 112



HT8G426 112



HT8G428 112



HT8G436 112

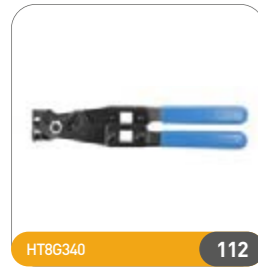

HT8G340 112

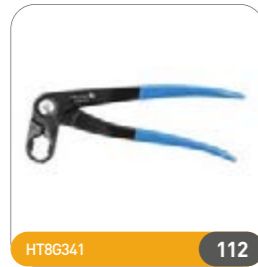

HT8G341 112

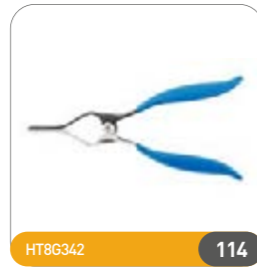

HT8G342 114



HT8G343 114



HT8G344 114

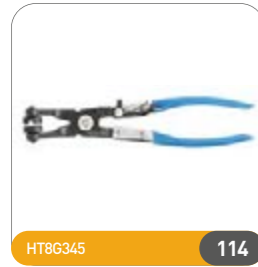

HT8G345 114

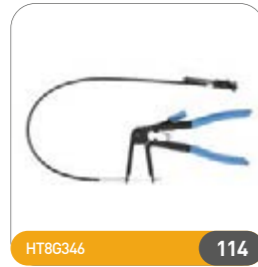

HT8G346 114



HT8G347 114



HT8G349 114



HT8G419 114



HT8G620 115



HT8G435 115

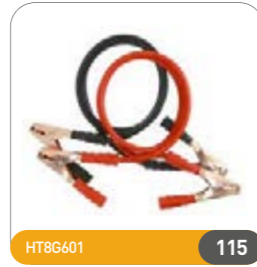

HT8G601 115



HT8G610 115



HT8G611 115



HT8G613 115



HT8G614 115



HT8G616 115



HT8G904 117



HT8G905 117



HT8G907 117



HT8G908 117



HT8G912 117



HT8G913 117



HT4R790 117



HT4R795 117



HT8G915 118

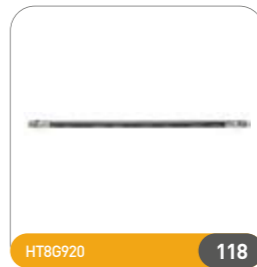

HT8G920 118



HT8G925 118



HT8G930 118



HT8G935 118



HT8G936 118



HT8G937 118

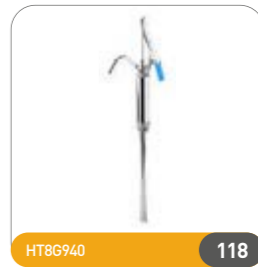

HT8G940 118



HT8G945 119



HT8G946 119



HT8G947 119



HT8G500 119



HT8G501 119



HT8G502 119



HT8G503 119



HT8G504 119

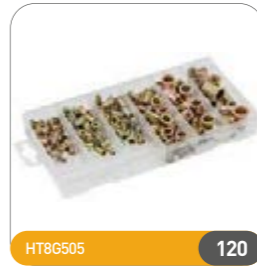

HT8G505 120



HT8G506 120



HT8G507 120



HT8G508 120



HT8G509 120



HT8G510 120



HT8G511 120



HT8G512 120

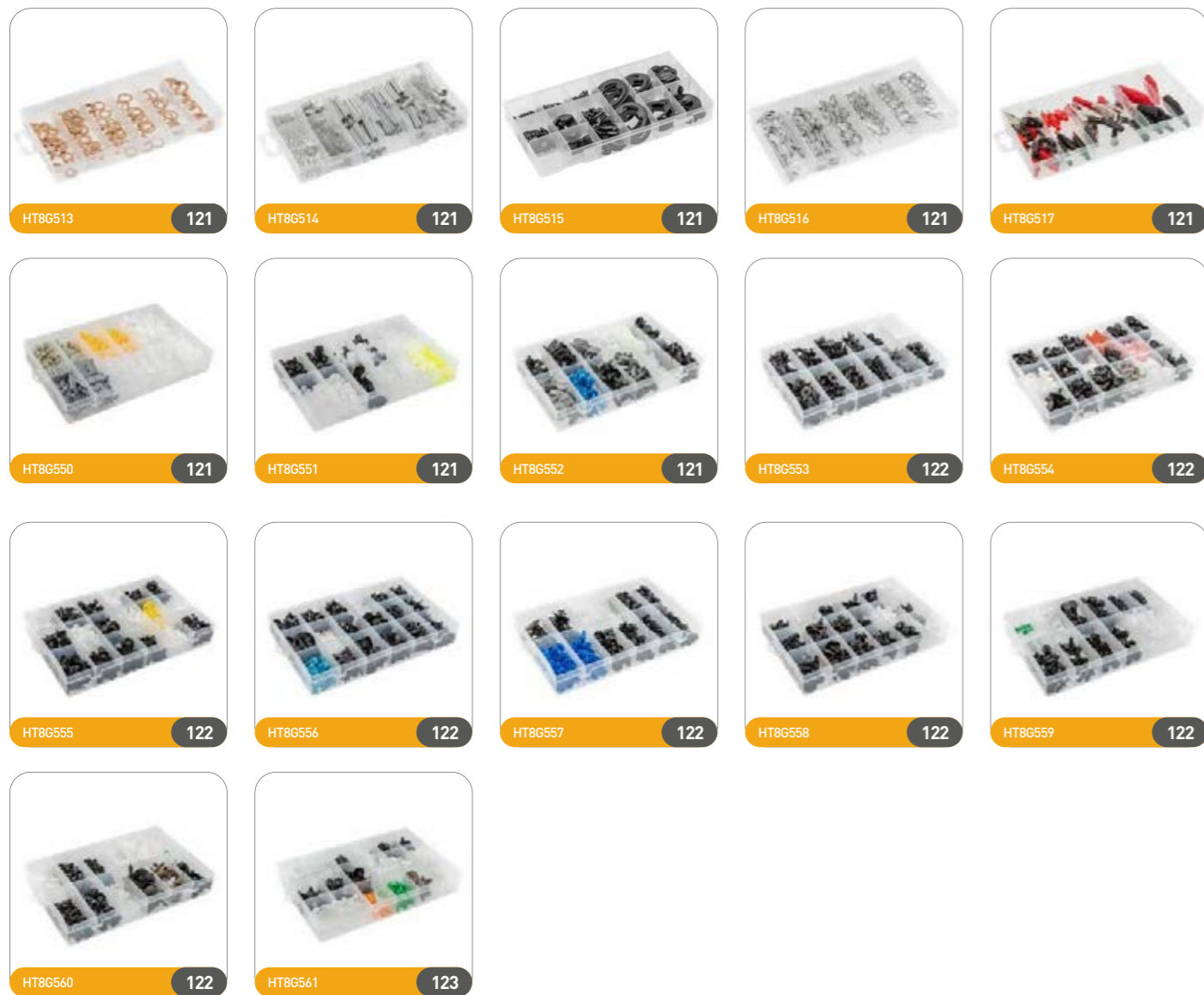

**DE** Werkstattwerkzeuge **EN** Workshop Tools **FR** Outillage D'Atelier **ES** Herramientas De Taller **HR** Alati Za Radionice  
**HU** Műhelyszerszámok **RO** Scule De Atelier **BG** Работни Инструменти



**DE** Werkzeuge Für Elektriker **EN** Tools For Electricians **FR** Outils Pour Electriciens **ES** Herramientas Para Electricistas  
**HR** Alati Za Električare **HU** Villanoszerelési Szerszámok **RO** Instrumente Pentru Electricieni **BG** Инструменти За Електротехници

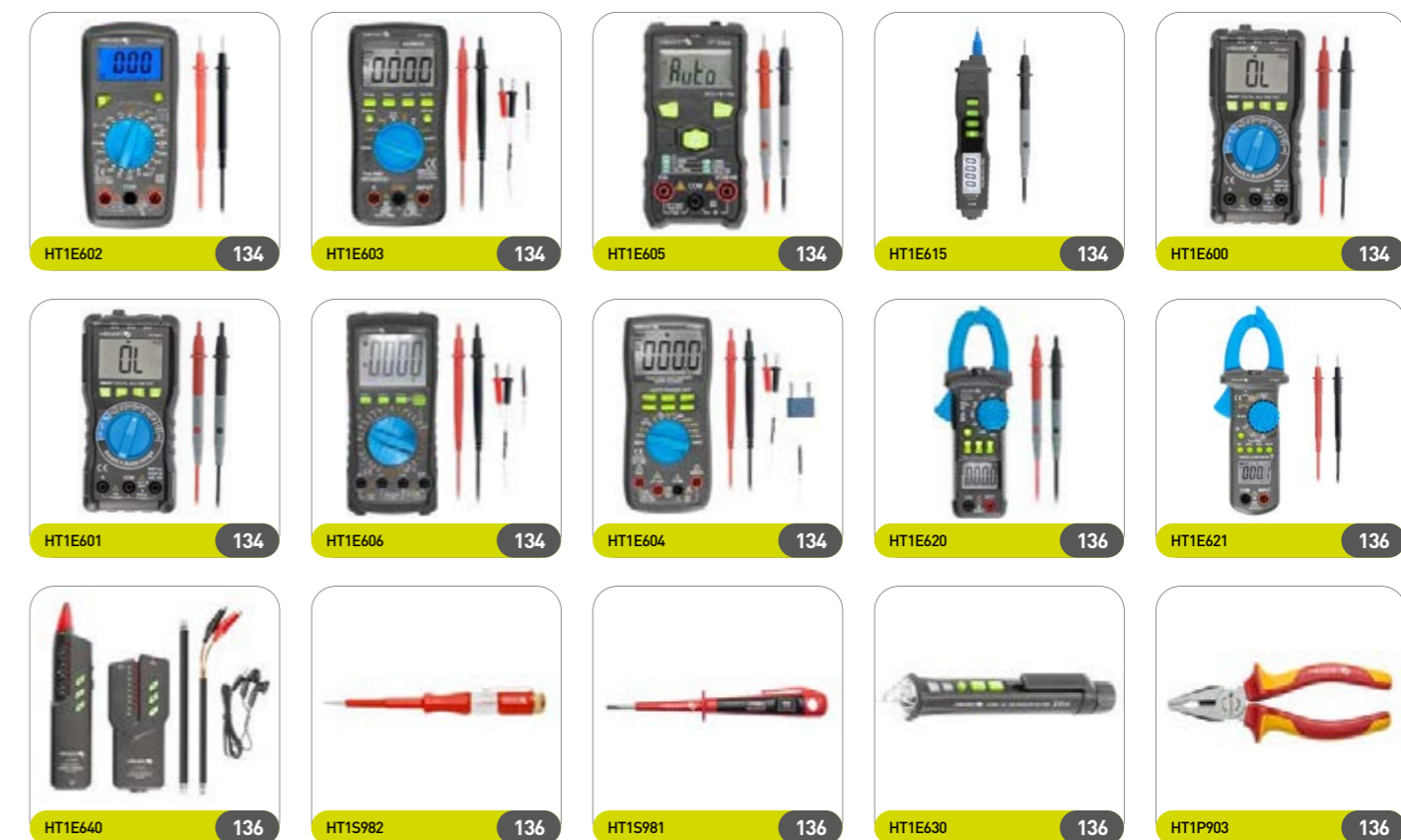

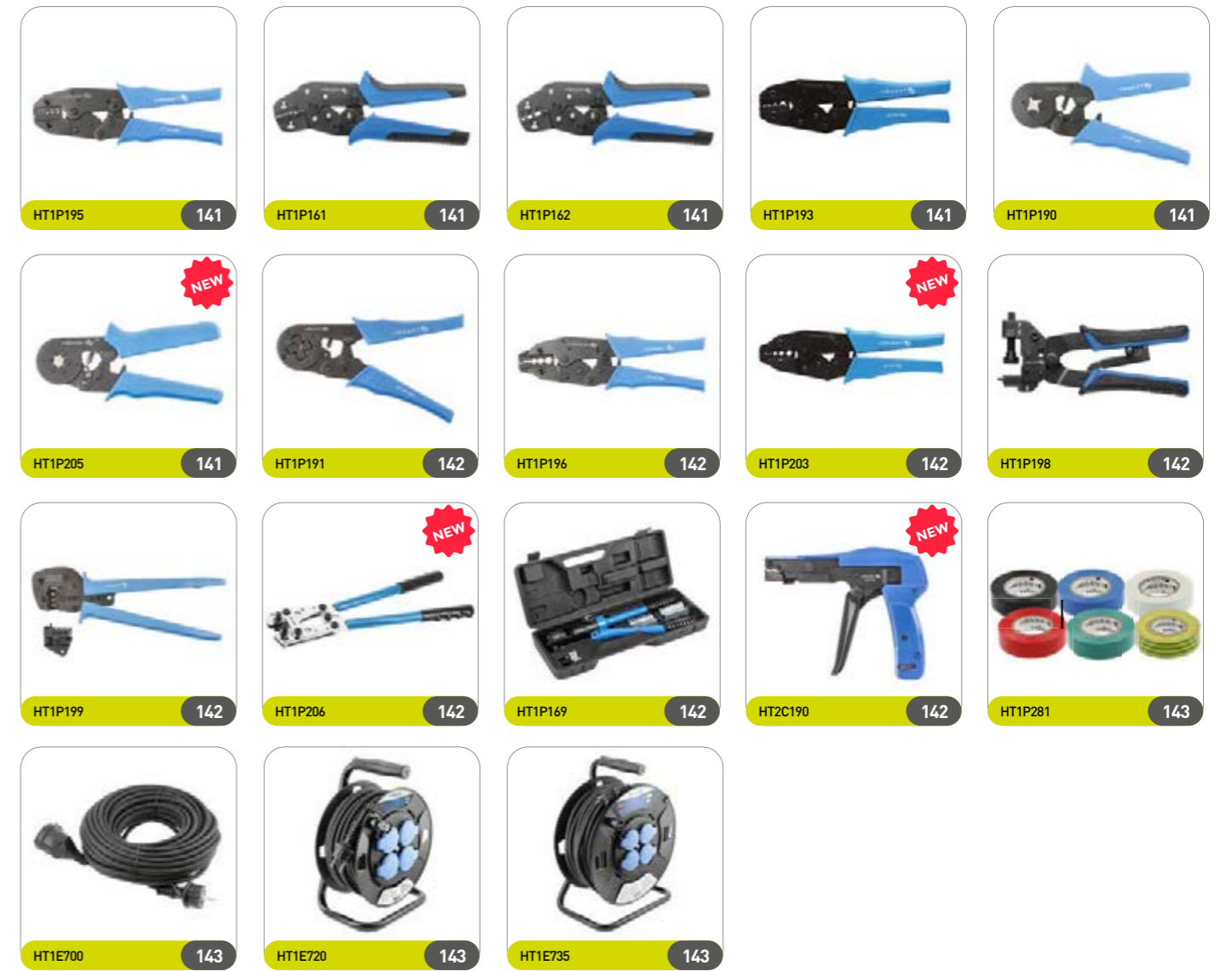

DE Werkzeuge Für Klempner EN Tools For Plumbers FR Outils Hydrauliques ES Herramientas Para Fontaneros HR Alati Za Vodoinstalatore HU Gépészeti Szerszámok RO Instrumente Pentru Instalatori BG Инструменти За Водопроводчик





DE Bauwerkzeuge EN Building Tools FR Outils De Construction ES Herramientas De Construcción HR Građevinski Alati  
HU Építőipari Szerszámok RO Unelte De Construcții BG Строителни Инструменти



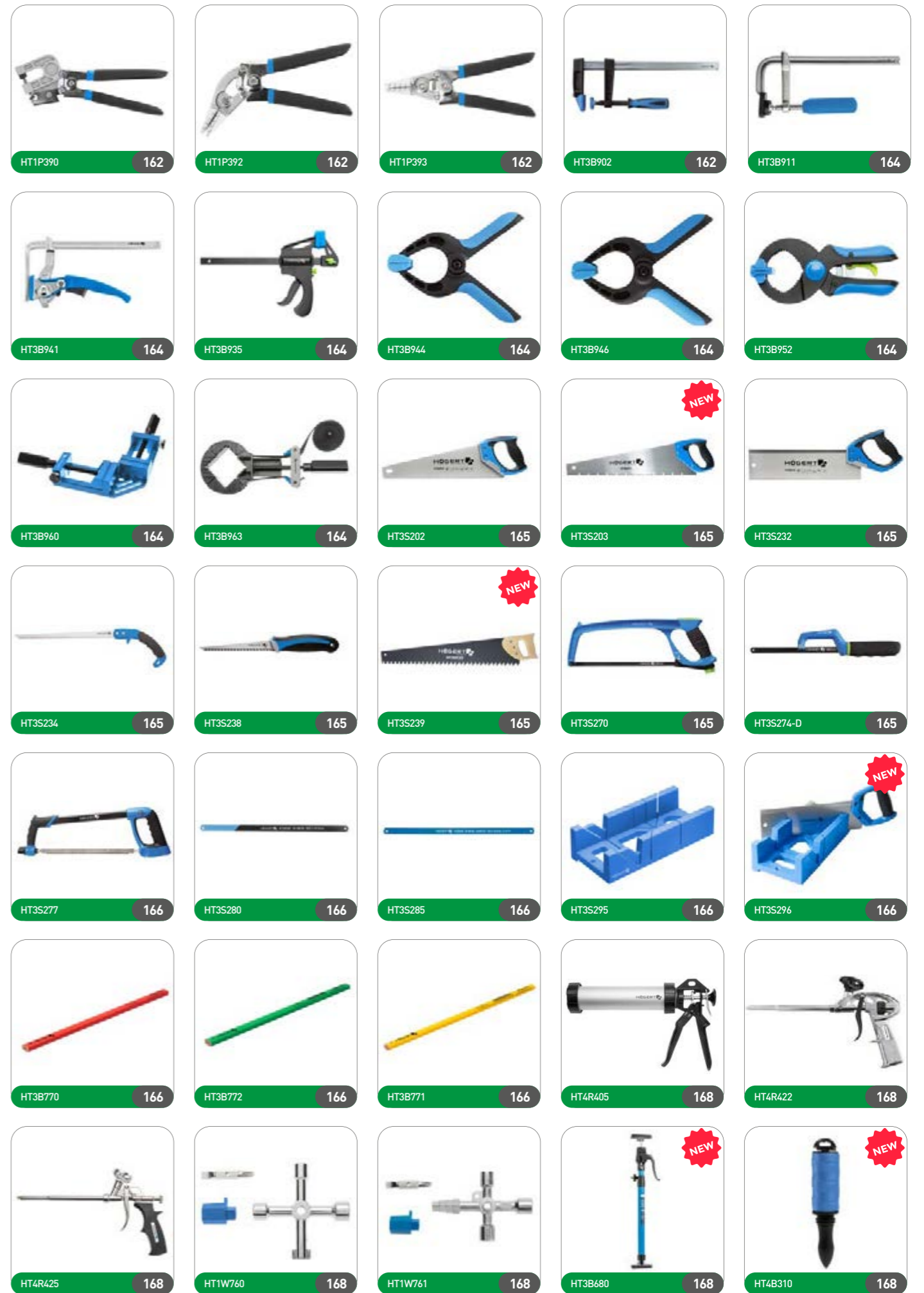



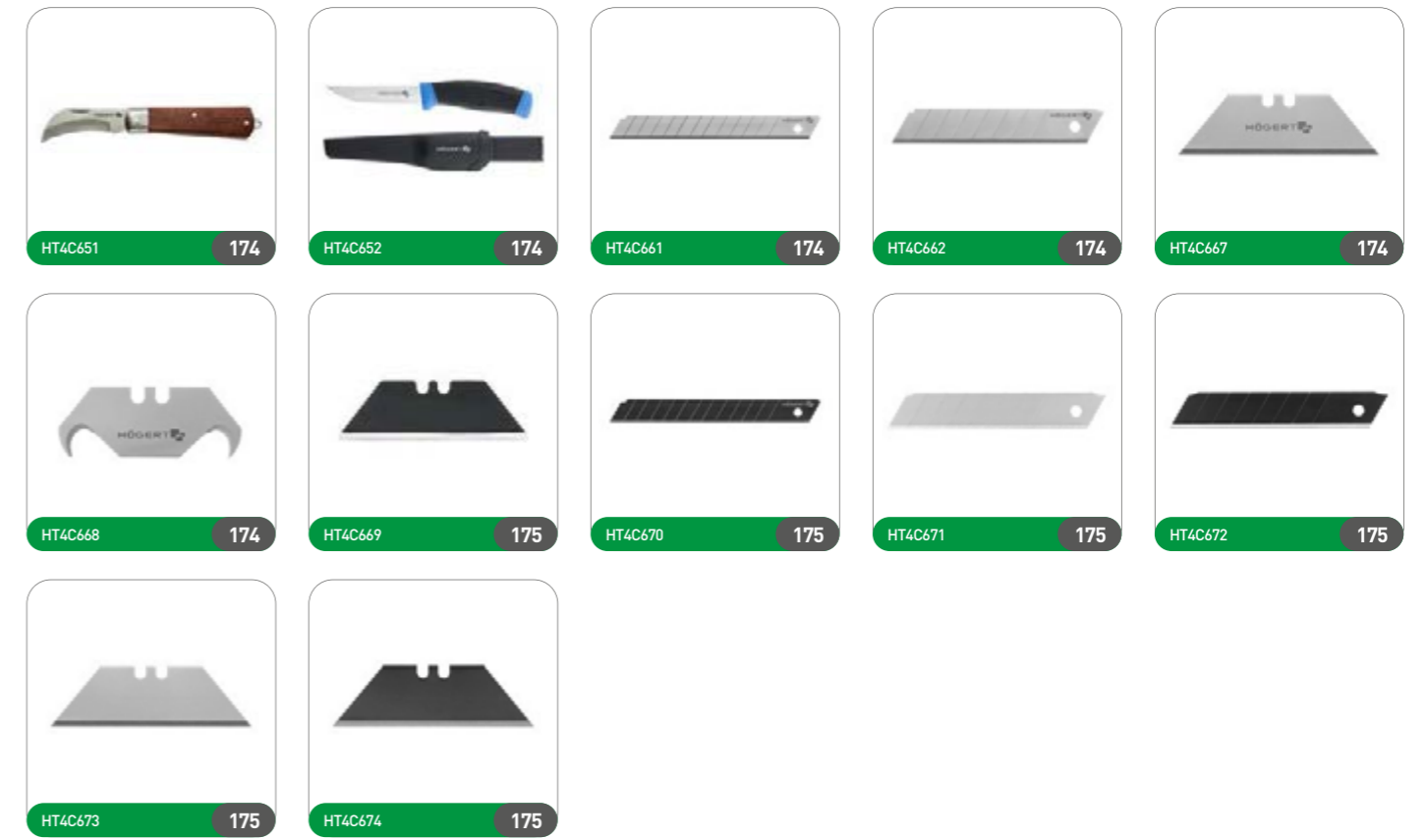

DE Messgeräte EN Measuring Tools FR Outils De Mesure ES Herramientas De Medición HR Mjerni Alati  
HU Mérőszerszámok RO Unelte De Măsură BG Измерващи Инструменти

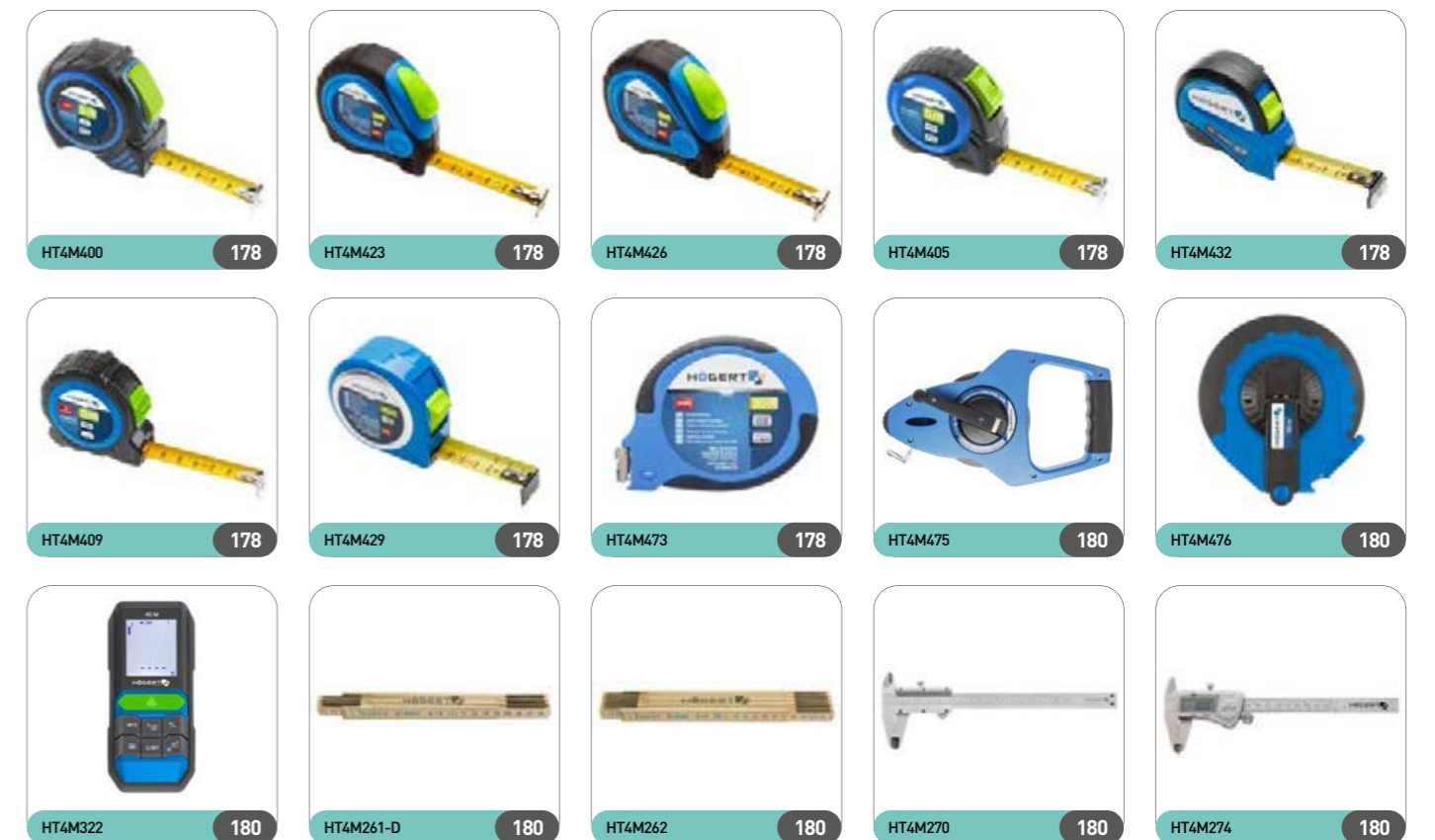



DE Zubehör für Elektrogeräte EN Power tools accessories FR Accessoires pour outils électriques  
 ES Accesorios para electro-herramientas HR Pribor za električne alate HU Elektromos szerszám tartozékok  
 RO Accesorii pentru scule electrice BG Аксесоари за електроинструменти



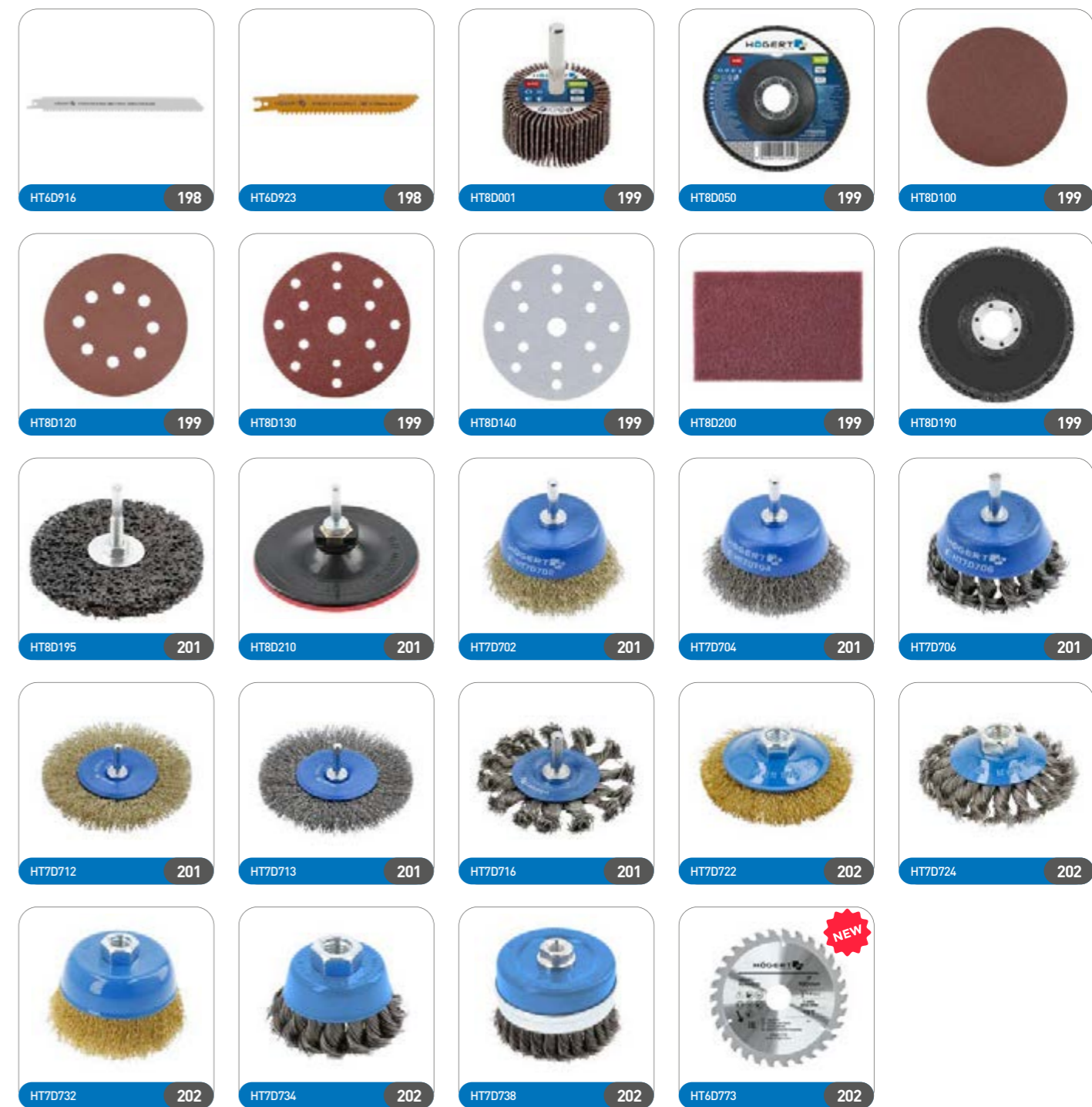

DE Anschlusswerkzeuge EN Joining Tools FR Outils De Connexion ES Herramientas De Unión HR Alati Za Spajanje  
HU Rögzítő Eszközök RO Instrumente De Îmbinare BG Свързващи Инструменти



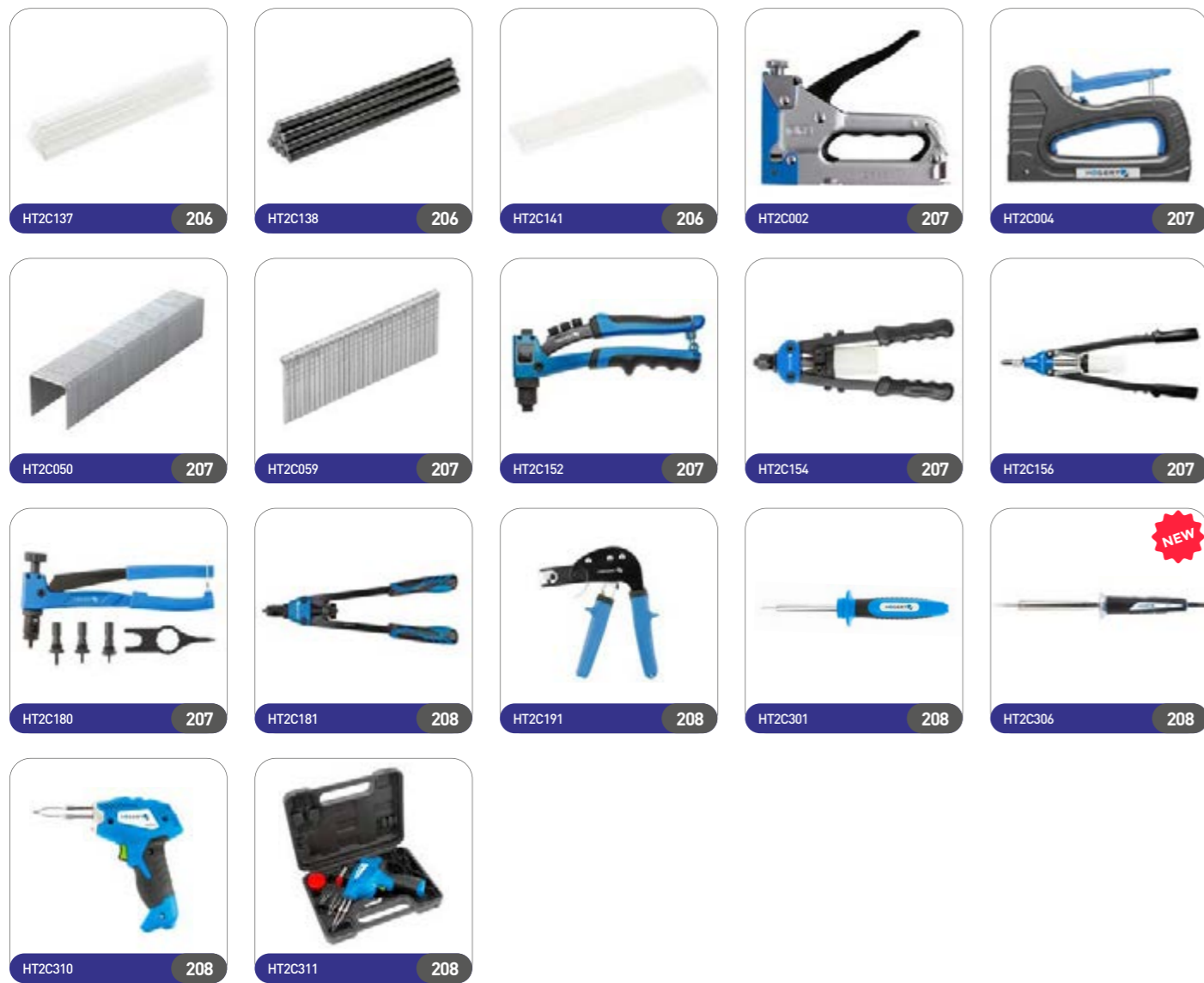

**DE** Elektrowerkzeuge **EN** Power Tools **FR** Outils Électroportatifs **ES** Herramientas Eléctricas **HR** Električni Alati  
**HU** Szerszámgépek **RO** Scule Electrice **BG** Електрически Инструменти



**DE** Zubehör Für Werkzeugkasten **EN** Tool Storage **FR** Stockage Des Outils **ES** Almacenamiento De Herramientas  
**HR** Pohrana Alata **HU** Szerszámtárolók **RO** Depozitarea Uneltelor **BG** Съхраняване На Инструменти



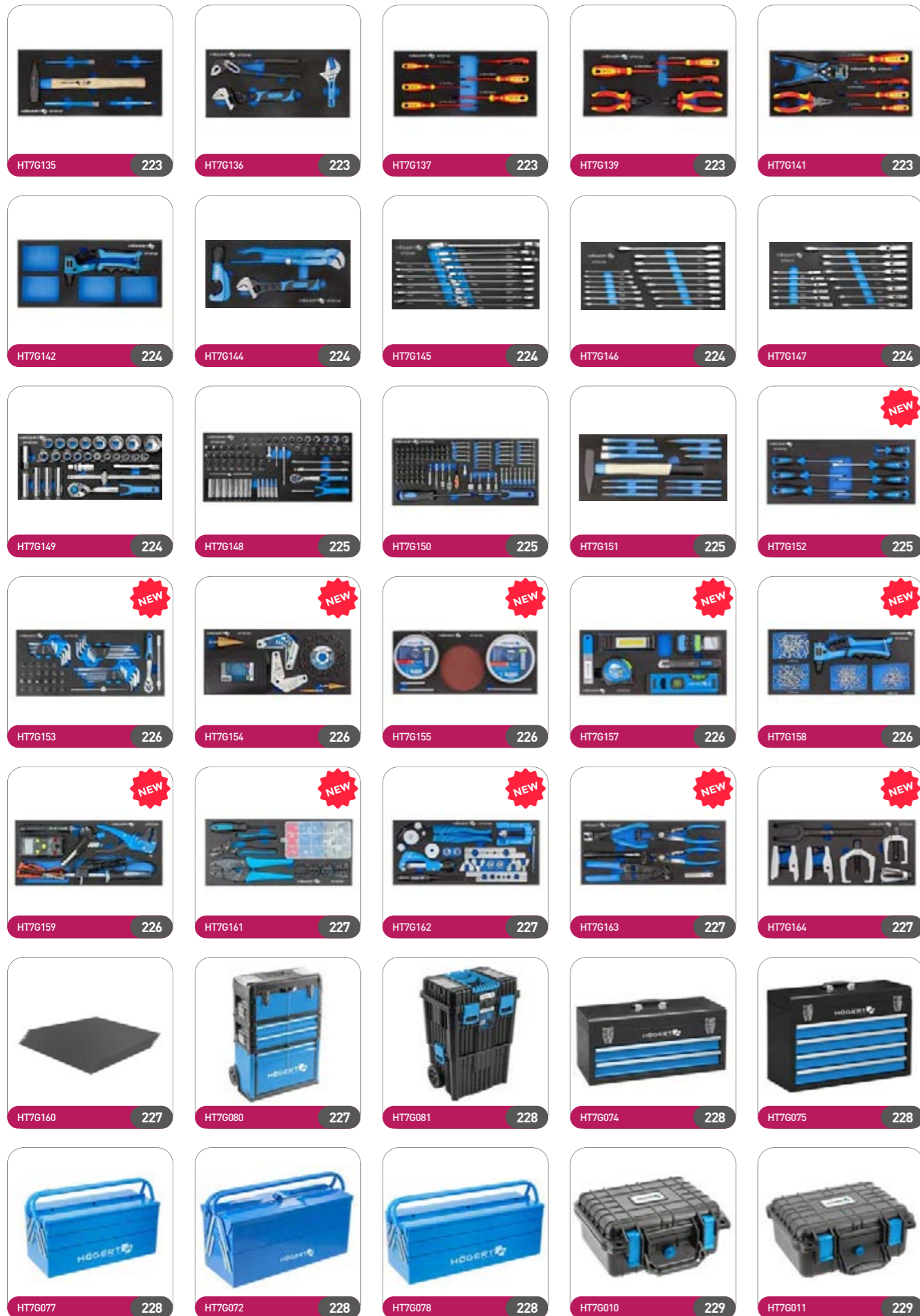

**HT1**

HT1A002 ..... 63	HT1A271 ..... 64	HT1E425 ..... 128	HT1P182 ..... 139	HT1P534 ..... 147	HT1P923 ..... 137	HT1R444 ..... 59	HT1S135 ..... 72	HT1S331 ..... 69	HT1S553 ..... 67
HT1A003 ..... 63	HT1A272 ..... 64	HT1E430 ..... 128	HT1P184 ..... 139	HT1P535 ..... 147	HT1P931 ..... 137	HT1R460 ..... 67	HT1S136 ..... 72	HT1S332 ..... 69	HT1S554 ..... 67
HT1A004 ..... 63	HT1A273 ..... 64	HT1E600 ..... 134	HT1P185 ..... 139	HT1P536 ..... 147	HT1R006 ..... 83	HT1R461 ..... 67	HT1S137 ..... 72	HT1S334 ..... 70	HT1S555 ..... 67
HT1A005 ..... 63	HT1A274 ..... 64	HT1E601 ..... 134	HT1P186 ..... 138	HT1P537 ..... 147	HT1R007 ..... 83	HT1R462 ..... 51	HT1S138 ..... 72	HT1S335 ..... 70	HT1S585 ..... 67
HT1A006 ..... 63	HT1A277 ..... 64	HT1E602 ..... 134	HT1P187 ..... 139	HT1P539 ..... 147	HT1R008 ..... 83	HT1R464 ..... 49	HT1S139 ..... 72	HT1S336 ..... 70	HT1S586 ..... 67
HT1A007 ..... 63	HT1A280 ..... 64	HT1E603 ..... 134	HT1P188 ..... 139	HT1P541 ..... 147	HT1R009 ..... 83	HT1R465 ..... 50	HT1S140 ..... 72	HT1S337 ..... 70	HT1S588 ..... 67
HT1A008 ..... 63	HT1A282 ..... 64	HT1E604 ..... 134	HT1P189 ..... 137	HT1P542 ..... 147	HT1R010 ..... 83	HT1R466 ..... 50	HT1S141 ..... 72	HT1S338 ..... 70	HT1S590 ..... 67
HT1A009 ..... 63	HT1A408 ..... 64	HT1E605 ..... 134	HT1P190 ..... 141	HT1P543 ..... 147	HT1R011 ..... 83	HT1R470 ..... 55	HT1S142 ..... 72	HT1S339 ..... 70	HT1S592 ..... 67
HT1A010 ..... 63	HT1A409 ..... 64	HT1E606 ..... 134	HT1P191 ..... 142	HT1P545 ..... 147	HT1R012 ..... 83	HT1R478 ..... 48	HT1S145 ..... 72	HT1S340 ..... 70	HT1S594 ..... 67
HT1A011 ..... 63	HT1A410 ..... 64	HT1E615 ..... 134	HT1P192 ..... 140	HT1P546 ..... 147	HT1R013 ..... 83	HT1R480 ..... 49	HT1S146 ..... 72	HT1S341 ..... 70	HT1S596 ..... 67
HT1A012 ..... 63	HT1A411 ..... 64	HT1E620 ..... 136	HT1P193 ..... 141	HT1P547 ..... 147	HT1R014 ..... 83	HT1R485 ..... 54	HT1S147 ..... 72	HT1S342 ..... 70	HT1S597 ..... 67
HT1A013 ..... 63	HT1A412 ..... 64	HT1E621 ..... 136	HT1P194 ..... 140	HT1P548 ..... 147	HT1R015 ..... 83	HT1R486 ..... 55	HT1S148 ..... 72	HT1S343 ..... 70	HT1S601 ..... 65
HT1A014 ..... 63	HT1A413 ..... 64	HT1E630 ..... 136	HT1P195 ..... 141	HT1P552 ..... 147	HT1R016 ..... 83	HT1R490 ..... 48	HT1S150 ..... 72	HT1S344 ..... 70	HT1S602 ..... 65
HT1A156 ..... 64	HT1A414 ..... 64	HT1E640 ..... 136	HT1P196 ..... 142	HT1P554 ..... 147	HT1R017 ..... 83	HT1R491 ..... 50	HT1S151 ..... 72	HT1S345 ..... 70	HT1S603 ..... 65
HT1A157 ..... 64	HT1A415 ..... 64	HT1E700 ..... 143	HT1P198 ..... 142	HT1P556 ..... 147	HT1R018 ..... 83	HT1R492 ..... 48	HT1S152 ..... 72	HT1S346 ..... 70	HT1S606 ..... 66
HT1A158 ..... 64	HT1A416 ..... 64	HT1E701 ..... 143	HT1P199 ..... 142	HT1P560 ..... 147	HT1R019 ..... 83	HT1S001 ..... 80	HT1S153 ..... 72	HT1S347 ..... 70	HT1S607 ..... 66
HT1A159 ..... 64	HT1A417 ..... 64	HT1E702 ..... 143	HT1P200 ..... 140	HT1P561 ..... 148	HT1R020 ..... 83	HT1S002 ..... 80	HT1S155 ..... 72	HT1S348 ..... 70	HT1S608 ..... 66
HT1A160 ..... 64	HT1A418 ..... 64	HT1E720 ..... 143	HT1P201 ..... 141	HT1P562 ..... 148	HT1R021 ..... 83	HT1S004 ..... 80	HT1S156 ..... 72	HT1S349 ..... 70	HT1S623 ..... 66
HT1A161 ..... 64	HT1A419 ..... 64	HT1E721 ..... 143	HT1P202 ..... 141	HT1P563 ..... 148	HT1R022 ..... 83	HT1S008 ..... 80	HT1S157 ..... 72	HT1S350 ..... 70	HT1S624 ..... 66
HT1A162 ..... 64	HT1A420 ..... 64	HT1E735 ..... 143	HT1P203 ..... 142	HT1P564 ..... 148	HT1R024 ..... 83	HT1S010 ..... 80	HT1S158 ..... 72	HT1S359 ..... 70	HT1S625 ..... 66
HT1A163 ..... 64	HT1A421 ..... 64	HT1P006 ..... 85	HT1P204 ..... 142	HT1P595 ..... 148	HT1R027 ..... 83	HT1S012 ..... 80	HT1S160 ..... 72	HT1S361 ..... 70	HT1S626 ..... 66
HT1A164 ..... 64	HT1A422 ..... 64	HT1P008 ..... 85	HT1P205 ..... 141	HT1P600 ..... 148	HT1R030 ..... 83	HT1S014 ..... 80	HT1S161 ..... 72	HT1S362 ..... 70	HT1S627 ..... 66
HT1A165 ..... 64	HT1A423 ..... 64	HT1P010 ..... 85	HT1P206 ..... 142	HT1P603 ..... 148	HT1R032 ..... 83	HT1S015 ..... 80	HT1S162 ..... 72	HT1S363 ..... 70	HT1S628 ..... 66
HT1A166 ..... 64	HT1A424 ..... 64	HT1P012 ..... 85	HT1P215 ..... 140	HT1P605 ..... 148	HT1R048 ..... 85	HT1S020 ..... 80	HT1S165 ..... 72	HT1S364 ..... 70	HT1S640 ..... 66
HT1A167 ..... 64	HT1A427 ..... 64	HT1P016 ..... 85	HT1P220 ..... 138	HT1P606 ..... 149	HT1R050 ..... 85	HT1S023 ..... 80	HT1S166 ..... 72	HT1S366 ..... 70	HT1S642 ..... 66
HT1A168 ..... 64	HT1A430 ..... 64	HT1P020 ..... 85	HT1P281 ..... 143	HT1P611 ..... 149	HT1R051 ..... 85	HT1S024 ..... 80	HT1S167 ..... 72	HT1S367 ..... 70	HT1S643 ..... 66
HT1A169 ..... 64	HT1A432 ..... 64	HT1P022 ..... 86	HT1P282 ..... 143	HT1P612 ..... 149	HT1R052 ..... 85	HT1S028 ..... 80	HT1S168 ..... 72	HT1S382 ..... 69	HT1S644 ..... 66
HT1A170 ..... 64	HT1A701 ..... 62	HT1P024 ..... 86	HT1P283 ..... 143	HT1P614 ..... 149	HT1R053 ..... 85	HT1S029 ..... 80	HT1S169 ..... 72	HT1S384 ..... 69	HT1S645 ..... 66
HT1A171 ..... 64	HT1A702 ..... 62	HT1P026 ..... 86	HT1P284 ..... 143	HT1P617 ..... 148	HT1R054 ..... 85	HT1S032 ..... 80	HT1S170 ..... 72	HT1S385 ..... 69	HT1S646 ..... 66
HT1A172 ..... 64	HT1A703 ..... 62	HT1P040 ..... 137	HT1P285 ..... 143	HT1P620 ..... 149	HT1R055 ..... 85	HT1S040 ..... 80	HT1S171 ..... 72	HT1S386 ..... 69	HT1S647 ..... 66
HT1A173 ..... 64	HT1A705 ..... 62	HT1P041 ..... 137	HT1P286 ..... 143	HT1P623 ..... 149	HT1R056 ..... 85	HT1S041 ..... 80	HT1S172 ..... 72	HT1S392 ..... 70	HT1S648 ..... 66
HT1A174 ..... 64	HT1A714 ..... 62	HT1P042 ..... 138	HT1P350 ..... 162	HT1P624 ..... 149	HT1R057 ..... 85	HT1S042 ..... 80	HT1S175 ..... 72	HT1S395 ..... 71	HT1S649 ..... 66
HT1A175 ..... 64	HT1A724 ..... 63	HT1P044 ..... 138	HT1P356 ..... 162	HT1P625 ..... 149	HT1R058 ..... 85	HT1S051 ..... 80	HT1S176 ..... 72	HT1S400 ..... 67	HT1S670 ..... 66
HT1A176 ..... 64	HT1A727 ..... 63	HT1P045 ..... 137	HT1P358 ..... 162	HT1P626 ..... 149	HT1R059 ..... 85	HT1S053 ..... 80	HT1S177 ..... 72	HT1S401 ..... 67	HT1S671 ..... 66
HT1A177 ..... 64	HT1A740 ..... 63	HT1P046 ..... 138	HT1P372 ..... 146	HT1P627 ..... 149	HT1R061 ..... 85	HT1S054 ..... 80	HT1S178 ..... 72	HT1S402 ..... 67	HT1S672 ..... 66
HT1A178 ..... 64	HT1A745 ..... 63	HT1P047 ..... 137	HT1P375 ..... 146	HT1P628 ..... 150	HT1R070 ..... 85	HT1S055 ..... 80	HT1S201 ..... 80	HT1S404 ..... 51	HT1S673 ..... 66
HT1A179 ..... 64	HT1A747 ..... 63	HT1P048 ..... 138	HT1P376 ..... 146	HT1P630 ..... 149	HT1R071 ..... 85	HT1S056 ..... 80	HT1S203 ..... 62	HT1S405 ..... 51	HT1S674 ..... 66
HT1A180 ..... 64	HT1A752 ..... 65	HT1P049 ..... 138	HT1P377 ..... 146	HT1P635 ..... 150	HT1R072 ..... 85	HT1S057 ..... 80	HT1S214 ..... 80	HT1S432 ..... 68	HT1S675 ..... 66
HT1A181 ..... 64	HT1A755 ..... 63	HT1P050 ..... 86	HT1P378 ..... 146	HT1P636 ..... 150	HT1R073 ..... 85	HT1S058 ..... 80	HT1S215 ..... 77	HT1S438 ..... 67	HT1S676 ..... 66
HT1A182 ..... 64	HT1A756 ..... 63	HT1P052 ..... 86	HT1P379 ..... 146	HT1P637 ..... 150	HT1R074 ..... 85	HT1S059 ..... 80	HT1S216 ..... 77	HT1S439 ..... 68	HT1S677 ..... 66
HT1A183 ..... 64	HT1A757 ..... 63	HT1P054 ..... 86	HT1P380 ..... 146	HT1P638 ..... 150	HT1R302 ..... 60	HT1S064 ..... 80	HT1S220 ..... 76	HT1S440 ..... 68	HT1S678 ..... 66
HT1A184 ..... 64	HT1A759 ..... 63	HT1P056 ..... 86	HT1P382 ..... 146	HT1P639 ..... 150	HT1R304 ..... 60	HT1S066 ..... 80	HT1S271 ..... 76	HT1S441 ..... 68	HT1S679 ..... 66
HT1A185 ..... 64	HT1A763 ..... 63	HT1P058 ..... 86	HT1P384 ..... 146	HT1P640 ..... 150	HT1R308 ..... 60	HT1S068 ..... 80	HT1S272 ..... 76	HT1S442 ..... 68	HT1S680 ..... 66
HT1A186 ..... 64	HT1A764 ..... 63	HT1P070 ..... 86	HT1P385 ..... 87	HT1P641 ..... 150	HT1R322 ..... 60	HT1S072 ..... 80	HT1S300 ..... 69	HT1S445 ..... 68	HT1S724 ..... 66
HT1A187 ..... 64	HT1A771 ..... 63	HT1P102 ..... 138	HT1P386 ..... 87	HT1P642 ..... 150	HT1R324 ..... 60	HT1S077 ..... 81	HT1S301 ..... 69	HT1S446 ..... 68	HT1S725 ..... 66
HT1A188 ..... 64	HT1A772 ..... 63	HT1P103 ..... 138	HT1P387 ..... 87	HT1P643 ..... 150	HT1R328 ..... 60	HT1S094 ..... 76	HT1S302 ..... 69	HT1S457 ..... 68	HT1S726 ..... 66
HT1A189 ..... 64	HT1A773 ..... 63	HT1P104 ..... 138	HT1P390 ..... 162	HT1P644 ..... 150	HT1R332 ..... 60	HT1S095 ..... 77	HT1S303 ..... 69	HT1S458 ..... 68	HT1S727 ..... 66
HT1A190 ..... 64	HT1A774 ..... 63	HT1P141 ..... 87	HT1P392 ..... 162	HT1P645 ..... 150	HT1R334 ..... 60	HT1S096 ..... 77	HT1S304 ..... 69	HT1S459 ..... 68	HT1S728 ..... 66
HT1A191 ..... 64	HT1A775 ..... 63	HT1P142 ..... 87	HT1P393 ..... 162	HT1P650 ..... 150	HT1R342 ..... 62	HT1S097 ..... 77	HT1S305 ..... 69	HT1S460 ..... 68	HT1S729 ..... 66
HT1A192 ..... 64	HT1A779 ..... 65	HT1P143 ..... 87	HT1P394 ..... 162	HT1P651 ..... 150	HT1R352 ..... 60	HT1S098 ..... 77	HT1S307 ..... 69	HT1S466 ..... 66	HT1S730 ..... 66
HT1A193 ..... 64	HT1A783 ..... 65	HT1P144 ..... 87	HT1P501 ..... 146	HT1P652 ..... 150	HT1R354 ..... 60	HT1S099 ..... 78	HT1S310 ..... 70	HT1S467 ..... 66	HT1S731 ..... 66
HT1A194 ..... 64	HT1A785 ..... 65	HT1P145 ..... 87	HT1P502 ..... 146	HT1P653 ..... 150	HT1R372 ..... 60	HT1S100 ..... 77	HT1S311 ..... 70	HT1S468 ..... 66	HT1S732 ..... 66
HT1A195 ..... 64	HT1A792 ..... 63	HT1P146 ..... 87	HT1P503 ..... 146	HT1P654 ..... 150	HT1R374 ..... 60	HT1S101 ..... 77	HT1S312 ..... 70	HT1S469 ..... 66	HT1S733 ..... 66
HT1A196 ..... 64	HT1A880 ..... 65	HT1P147 ..... 87	HT1P506 ..... 146	HT1P655 ..... 150	HT1R382 ..... 60	HT1S105 ..... 78	HT1S313 ..... 70	HT1S470 ..... 66	HT1S734 ..... 66
HT1A197 ..... 64	HT1A884 ..... 65	HT1P148 ..... 87	HT1P507 ..... 146	HT1P656 ..... 150	HT1R391 ..... 62	HT1S120 ..... 71	HT1S314 ..... 69	HT1S471 ..... 66	HT1S735 ..... 66
HT1A198 ..... 64	HT1A886 ..... 65	HT1P160 ..... 140	HT1P508 ..... 146	HT1P657 ..... 150	HT1R395 ..... 60	HT1S121 ..... 71	HT1S315 ..... 69	HT1S472 ..... 66	HT1S736 ..... 66
HT1A199 ..... 64	HT1A888 ..... 65	HT1P161 ..... 141	HT1P519 ..... 147	HT1P680 ..... 150	HT1R397 ..... 85	HT1S122 ..... 71	HT1S316 ..... 69	HT1S473 ..... 66	HT1S737 ..... 66
HT1A200 ..... 64	HT1E402 ..... 126	HT1P162 ..... 141	HT1P520 ..... 147	HT1P903 ..... 136	HT1R410 ..... 49	HT1S123 ..... 71	HT1S317 ..... 69	HT1S474 ..... 66	HT1S738 ..... 66
HT1A201 ..... 64	HT1E406 ..... 126	HT1P169 ..... 142	HT1P522 ..... 147	HT1P905 ..... 136	HT1R416 ..... 54	HT1S125 ..... 71	HT1S318 ..... 71	HT1S475 ..... 66	HT1S739 ..... 66
HT1A202 ..... 64	HT1E407 ..... 126	HT1P170 ..... 139	HT1P524 ..... 147	HT1P907 ..... 136	HT1R424 ..... 56	HT1S126 ..... 71	HT1S319 ..... 71	HT1S476 ..... 66	HT1S740 ..... 66
HT1A203 ..... 64	HT1E408 ..... 126	HT1P171 ..... 139	HT1P526 ..... 147	HT1P909 ..... 136	HT1R425 ..... 56	HT1S127 ..... 71	HT1S321 ..... 71	HT1S477 ..... 66	HT1S741 ..... 66
HT1A204 ..... 64	HT1E409 ..... 126	HT1P172 ..... 140	HT1P530 ..... 147	HT1P911 ..... 136	HT1R426 ..... 57	HT1S128 ..... 71	HT1S322 ..... 71	HT1S478 ..... 66	HT1S742 ..... 66
HT1A205 ..... 64	HT1E410 ..... 128	HT1P176 ..... 140	HT1P531 ..... 147	HT1P913 ..... 137	HT1R432 ..... 57	HT1S130 ..... 71	HT1S323 ..... 70	HT1S479 ..... 66	HT1S743 ..... 66
HT1A206 ..... 64	HT1E420 ..... 128	HT1P177 ..... 140	HT1P532 ..... 147	HT1P917 ..... 137	HT1R439 ..... 53	HT1S131 ..... 71	HT1S324 ..... 71	HT1S480 ..... 66	HT1S744 ..... 66
HT1A207 ..... 64	HT1E424 ..... 126	HT1P181 ..... 139	HT1P533 ..... 147	HT1P919 ..... 137	HT1R440 ..... 58	HT1S132 ..... 71	HT1S330 ..... 69	HT1S481 ..... 66	HT1S745 ..... 66

HT1S790.....66	HT1W426.....83	HT2C137.....206	HT3B062.....156	HT3B724.....160	HT3S203.....165	HT4M005.....181	HT4R016.....91	HT4R315.....92	HT4R876.....95
HT1S792.....66	HT1W427.....83	HT2C138.....206	HT3B064.....156	HT3B725.....160	HT3S204.....165	HT4M006.....182	HT4R017.....91	HT4R316.....92	HT4R890.....95
HT1S794.....66	HT1W428.....83	HT2C141.....206	HT3B066.....156	HT3B726.....160	HT3S205.....165	HT4M007.....181	HT4R018.....91	HT4R320.....92	HT4R891.....95
HT1S796.....66	HT1W430.....83	HT2C152.....207	HT3B069.....156	HT3B727.....160	HT3S206.....165	HT4M008.....182	HT4R019.....91	HT4R324.....92	HT4R892.....95
HT1S797.....66	HT1W432.....83	HT2C154.....207	HT3B070.....156	HT3B728.....160	HT3S207.....165	HT4M009.....181	HT4R020.....91	HT4R326.....92	HT4R894.....95
HT1S846.....71	HT1W436.....83	HT2C156.....207	HT3B071.....156	HT3B729.....160	HT3S232.....165	HT4M010.....182	HT4R021.....91	HT4R328.....92	
HT1S847.....71	HT1W441.....83	HT2C180.....207	HT3B072.....156	HT3B770.....166	HT3S234.....165	HT4M011.....181	HT4R022.....91	HT4R402.....170	
HT1S848.....71	HT1W446.....83	HT2C181.....208	HT3B073.....156	HT3B771.....166	HT3S238.....165	HT4M012.....182	HT4R023.....91	HT4R405.....168	
HT1S849.....71	HT1W450.....83	HT2C190.....142	HT3B076.....156	HT3B772.....166	HT3S239.....165	HT4M013.....181	HT4R024.....91	HT4R422.....168	
HT1S850.....71	HT1W455.....83	HT2C191.....208	HT3B091.....156	HT3B774.....170	HT3S240.....165	HT4M015.....182	HT4R027.....91	HT4R425.....168	
HT1S851.....71	HT1W490.....85	HT2C301.....208	HT3B094.....156	HT3B775.....170	HT3S270.....165	HT4M016.....181	HT4R030.....91	HT4R502.....128	
HT1S852.....71	HT1W492.....83	HT2C303.....208	HT3B095.....157	HT3B776.....170	HT3S274-D.....165	HT4M020.....182	HT4R032.....91	HT4R504.....128	
HT1S853.....71	HT1W496.....83	HT2C306.....208	HT3B097.....157	HT3B777.....170	HT3S277.....166	HT4M021.....181	HT4R049.....91	HT4R506.....128	
HT1S885.....71	HT1W590.....82	HT2C308.....208		HT3B778.....170	HT3S280.....166	HT4M040.....181	HT4R060.....91	HT4R507.....129	
HT1S886.....71	HT1W598.....83	HT2C310.....208		HT3B800.....161	HT3S285.....166	HT4M070.....182	HT4R061.....91	HT4R508.....128	
HT1S888.....71	HT1W599.....83	HT2C311.....208		HT3B801.....161	HT3S286.....166	HT4M071.....182	HT4R062.....91	HT4R509.....129	
HT1S890.....71	HT1W701.....62	HT2C401.....150		HT3B802.....161	HT3S295.....166	HT4M072.....182	HT4R063.....91	HT4R510.....129	
HT1S902.....81	HT1W706.....62	HT2C500.....151		HT3B804.....161	HT3S296.....166	HT4M074.....182	HT4R064.....91	HT4R512.....129	
HT1S903.....81	HT1W707.....62	HT2C501.....151		HT3B808.....161		HT4M079.....182	HT4R065.....91	HT4R518.....130	
HT1S904.....81	HT1W708.....62	HT2C502.....151		HT3B809.....161		HT4M202.....180	HT4R066.....91	HT4R519.....129	
HT1S905.....81	HT1W710.....62	HT2C503.....151		HT3B810.....161		HT4M203.....180	HT4R067.....91	HT4R520.....129	
HT1S920.....82	HT1W711.....62	HT2C504.....151		HT3B811.....161		HT4M206.....180	HT4R068.....91	HT4R521.....129	
HT1S922.....82	HT1W712.....62	HT2C505.....151		HT3B841.....162		HT4M214.....181	HT4R069.....91	HT4R522.....129	
HT1S924.....82	HT1W713.....62	HT2C509.....151		HT3B842.....162		HT4M215.....181	HT4R070.....91	HT4R621.....90	
HT1S940.....82	HT1W714.....62	HT2C550.....212		HT3B843.....162		HT4M216.....181	HT4R071.....91	HT4R622.....90	
HT1S941.....82	HT1W730.....82	HT2C551.....212		HT3B845.....162		HT4M217.....181	HT4R072.....91	HT4R623.....90	
HT1S944.....82	HT1W760.....168	HT2C552.....212		HT3B848.....162		HT4M218.....170	HT4R074.....91	HT4R625.....90	
HT1S960.....82	HT1W761.....168	HT2E100.....214		HT3B850.....162		HT4M261-D.....180	HT4R077.....91	HT4R626.....90	
HT1S961.....82	HT1W800.....73	HT2E101.....214		HT3B852.....162		HT4M262.....180	HT4R080.....91	HT4R630.....90	
HT1S962.....82	HT1W801.....73	HT2E105.....214		HT3B880.....162		HT4M270.....180	HT4R081.....91	HT4R635.....90	
HT1S965.....82	HT1W802.....72	HT2E106.....214		HT3B881.....162		HT4M274.....180	HT4R104.....91	HT4R650.....90	
HT1S966.....82	HT1W803.....73	HT2E115.....214		HT3B882.....162		HT4M322.....180	HT4R111.....92	HT4R651.....91	
HT1S968.....82	HT1W804.....73	HT2E116.....215		HT3B902.....162		HT4M323.....180	HT4R112.....92	HT4R652.....91	
HT1S969.....82	HT1W806.....76	HT2E130.....215		HT3B904.....162		HT4M324.....180	HT4R113.....92	HT4R712.....93	
HT1S973.....82	HT1W807.....73	HT2E200.....212		HT3B906.....162		HT4M340.....182	HT4R114.....92	HT4R716.....93	
HT1S974.....82	HT1W808.....73	HT2E210.....212		HT3B908.....162		HT4M341.....182	HT4R115.....92	HT4R718.....93	
HT1S976.....82	HT1W809.....75	HT2E211.....212		HT3B909.....162		HT4M342.....183	HT4R116.....92	HT4R746.....93	
HT1S977.....82	HT1W810.....75	HT3B001.....154		HT3B910.....162		HT4M400.....178	HT4R120.....92	HT4R747.....93	
HT1S981.....136	HT1W814.....73	HT3B003.....154		HT3B911.....164		HT4M401.....178	HT4R122.....92	HT4R748.....93	
HT1S982.....136	HT1W816.....76	HT3B005.....154		HT3B912.....164		HT4M402.....178	HT4R124.....92	HT4R749.....93	
HT1S986.....81	HT1W817.....76	HT3B008.....154		HT3B913.....164		HT4M405.....178	HT4R141.....91	HT4R750.....94	
HT1S990.....81	HT1W818.....73	HT3B010.....154		HT3B914.....164		HT4M406.....178	HT4R142.....91	HT4R751.....94	
HT1S994.....81	HT1W820.....75	HT3B015.....154		HT3B915.....164		HT4M407.....178	HT4R143.....91	HT4R755.....94	
HT1S996.....81	HT1W821.....75	HT3B020.....154		HT3B916.....164		HT4M409.....178	HT4R144.....91	HT4R757.....94	
HT1S997.....81	HT1W822.....75	HT3B021.....154		HT3B917.....164		HT4M410.....178	HT4R145.....91	HT4R758.....94	
HT1S998.....81	HT1W825.....75	HT3B023.....154		HT3B918.....164		HT4M411.....178	HT4R146.....91	HT4R780.....99	
HT1W406.....83	HT1W826.....75	HT3B025.....154		HT3B920.....162		HT4M423.....178	HT4R147.....91	HT4R781.....103	
HT1W407.....83	HT1W827.....75	HT3B028.....154		HT3B921.....162		HT4M425.....178	HT4R148.....91	HT4R790.....117	
HT1W408.....83	HT1W830.....75	HT3B029.....154		HT3B922.....162		HT4M426.....178	HT4R149.....91	HT4R795.....117	
HT1W409.....83	HT1W831.....76	HT3B030.....154		HT3B935.....164		HT4M428.....178	HT4R151.....91	HT4R801.....94	
HT1W410.....83	HT1W879.....62	HT3B031.....154		HT3B936.....164		HT4M429.....178	HT4R152.....91	HT4R802.....94	
HT1W411.....83		HT3B033.....154		HT3B937.....164		HT4M432.....178	HT4R153.....91	HT4R803.....94	
HT1W412.....83		HT3B034.....154		HT3B938.....164		HT4M433.....178	HT4R154.....91	HT4R804.....94	
HT1W413.....83		HT3B035.....154		HT3B939.....164		HT4M473.....178	HT4R155.....91	HT4R810.....94	
HT1W414.....83		HT3B036.....154		HT3B940.....164		HT4M475.....180	HT4R156.....91	HT4R811.....94	
HT1W415.....83		HT3B038.....154		HT3B941.....164		HT4M476.....180	HT4R157.....91	HT4R812.....94	
HT1W416.....83		HT3B039.....154		HT3B942.....164		HT4M477.....180	HT4R158.....91	HT4R813.....94	
HT1W417.....83		HT3B041.....156		HT3B943.....164		HT4M478.....180	HT4R159.....91	HT4R820.....94	
HT1W418.....83		HT3B043.....156		HT3B944.....164		HT4M479.....180	HT4R211.....92	HT4R821.....95	
HT1W419.....83		HT3B044.....156		HT3B946.....164		HT4R006.....91	HT4R212.....92	HT4R822.....95	
HT1W420.....83		HT3B045.....156		HT3B952.....164		HT4R010.....91	HT4R213.....92	HT4R870.....95	
HT1W421.....83		HT3B046.....156		HT3B954.....164		HT4R011.....91	HT4R214.....92	HT4R871.....95	
HT1W422.....83		HT3B048.....156		HT3B960.....164		HT4R012.....91	HT4R217.....92	HT4R872.....95	
HT1W424.....83		HT3B052.....156		HT3B963.....164		HT4R013.....91	HT4R302.....92	HT4R873.....95	
HT1W425.....83		HT3B060.....156		HT3S202.....165		HT4R014.....91	HT4R304.....92	HT4R874.....95	
						HT4R015.....91	HT4R306.....92	HT4R875.....95	

**HT6**

HT6D084.....189	HT6D085.....189	HT6D086.....189	HT6D088.....189	HT6D090.....189	HT6D103.....188	HT6D104.....188	HT6D105.....188	HT6D108.....188	HT6D109.....188	HT6D111.....188	HT6D112.....188	HT6D114.....188	HT6D117.....188	HT6D119.....188	HT6D122.....188	HT6D123.....188	HT6D126.....188	HT6D127.....188	HT6D129.....188	HT6D132.....188	HT6D134.....188	HT6D137.....188	HT6D141.....188	HT6D148.....189	HT6D186.....189	HT6D201.....186	HT6D203.....186	HT6D204.....186	HT6D205.....186	HT6D206.....186	HT6D207.....186	HT6D210.....186	HT6D213.....186	HT6D214.....186	HT6D215.....186	HT6D218.....186	HT6D220.....186	HT6D224.....186	HT6D226.....186	HT6D231.....186	HT6D233.....186	HT6D236.....186	HT6D237.....186	HT6D240.....186	HT6D242.....186	HT6D248.....186	HT6D280.....186	HT6D281.....186	HT6D282.....186	HT6D284.....186	HT6D290.....187	HT6D291.....187	HT6D292.....187	HT6D310.....190
-----------------	-----------------	-----------------	-----------------	-----------------	-----------------	-----------------	-----------------	-----------------	-----------------	-----------------	-----------------	-----------------	-----------------	-----------------	-----------------	-----------------	-----------------	-----------------	-----------------	-----------------	-----------------	-----------------	-----------------	-----------------	-----------------	-----------------	-----------------	-----------------	-----------------	-----------------	-----------------	-----------------	-----------------	-----------------	-----------------	-----------------	-----------------	-----------------	-----------------	-----------------	-----------------	-----------------	-----------------	-----------------	-----------------	-----------------	-----------------	-----------------	-----------------	-----------------	-----------------	-----------------	-----------------	-----------------

HT6D312	190
HT6D314	190
HT6D316	190
HT6D317	190
HT6D320	190
HT6D321	189
HT6D322	189
HT6D323	189
HT6D324	189
HT6D325	189
HT6D326	190
HT6D330	189
HT6D336	189
HT6D344	190
HT6D345	190
HT6D346	190
HT6D348	190
HT6D370	186
HT6D378	188
HT6D380	188
HT6D382	188
HT6D383	188
HT6D384	188
HT6D385	188
HT6D388	188
HT6D389	188
HT6D392	188
HT6D404	192
HT6D406	192
HT6D408	192
HT6D410	192
HT6D412	192
HT6D414	192
HT6D416	192
HT6D417	192
HT6D420	192
HT6D424	192
HT6D426	192
HT6D429	192
HT6D431	192
HT6D433	192
HT6D435	192
HT6D436	192
HT6D437	192
HT6D439	192
HT6D440	192
HT6D441	192
HT6D442	192
HT6D445	192
HT6D447	192
HT6D448	192
HT6D450	192
HT6D452	192
HT6D453	192
HT6D455	192
HT6D462	192
HT6D463	192
HT6D466	192
HT6D470	187
HT6D476	187
HT6D478	187
HT6D484	187
HT6D486	187
HT6D487	187

HT6D489	187
HT6D490	187
HT6D492	187
HT6D504	192
HT6D505	192
HT6D523	190
HT6D524	190
HT6D525	190
HT6D526	190
HT6D527	190
HT6D528	190
HT6D530	190
HT6D541	190
HT6D543	190
HT6D544	190
HT6D545	190
HT6D546	190
HT6D547	190
HT6D548	190
HT6D549	190
HT6D550	190
HT6D551	190
HT6D552	190
HT6D553	190
HT6D554	190
HT6D555	190
HT6D556	190
HT6D557	190
HT6D558	190
HT6D601	193
HT6D602	193
HT6D604	193
HT6D606	194
HT6D616	193
HT6D630	194
HT6D631	194
HT6D632	194
HT6D633	194
HT6D634	194
HT6D635	194
HT6D636	194
HT6D638	194
HT6D640	194
HT6D650	197
HT6D650-2	194
HT6D651	196
HT6D653	196
HT6D654-2	196
HT6D656-2	196
HT6D657	196
HT6D659	196
HT6D660	197
HT6D660-2	196
HT6D661-2	196
HT6D663-2	197
HT6D665	197
HT6D666	197
HT6D667	197
HT6D668	197
HT6D668	197
HT6D670	197
HT6D671	197
HT6D672	198
HT6D673	198
HT6D674	197

HT6D680-2	198
HT6D682-2	197
HT6D690	197
HT6D701	192
HT6D702	192
HT6D703	192
HT6D706	192
HT6D711	192
HT6D712	192
HT6D716	192
HT6D721	193
HT6D722	193
HT6D742	193
HT6D746	193
HT6D748	193
HT6D750	193
HT6D751	193
HT6D752	193
HT6D753	193
HT6D754	193
HT6D755	193
HT6D756	193
HT6D757	193
HT6D758	193
HT6D773	202
HT6D774	202
HT6D775	202
HT6D776	202
HT6D777	202
HT6D778	202
HT6D779	202
HT6D780	202
HT6D781	202
HT6D782	202
HT6D783	202
HT6D784	202
HT6D785	202
HT6D786	202
HT6D787	202
HT6D788	202
HT6D789	202
HT6D790	202
HT6D800	188
HT6D802	188
HT6D807	188
HT6D812	188
HT6D817	188
HT6D822	188
HT6D824	188
HT6D825	188
HT6D827	188
HT6D832	188
HT6D834	188
HT6D837	188
HT6D840	188
HT6D842	188
HT6D844	188
HT6D847	188
HT6D852	188
HT6D854	188
HT6D857	188
HT6D862	188
HT6D867	188
HT6D872	188
HT6D874	188

HT6D877	188
HT6D882	188
HT6D887	188
HT6D892	188
HT6D893	188
HT6D894	188
HT6D895	188
HT6D896	188
HT6D897	188
HT6D898	188
HT6D899	188
HT6D900	188
HT6D901	198
HT6D902	198
HT6D904	198
HT6D916	198
HT6D923	198
HT6D992	193
HT6R002	93
HT6R004	93
HT6R006	93

**HT7**

HT7D110	190
HT7D112	190
HT7D114	190
HT7D116	190
HT7D118	190
HT7D120	190
HT7D122	190
HT7D124	190
HT7D125	190
HT7D128	190
HT7D130	190
HT7D132	190
HT7D135	190
HT7D138	190
HT7D140	190
HT7D158	190
HT7D270	192
HT7D272	192
HT7D274	192
HT7D276	192
HT7D278	192
HT7D280	192
HT7D282	192
HT7D284	192
HT7D285	192
HT7D286	192
HT7D290	192
HT7D294	192
HT7D296	192
HT7D306	192
HT7D308	192
HT7D310	192
HT7D312	192
HT7D314	192
HT7D318	192
HT7D322	192
HT7D325	192
HT7D332	192
HT7D335	192
HT7D338	192
HT7D340	192
HT7D344	192

HT7D350	192
HT7D353	192
HT7D360	192
HT7D365	192
HT7D367	192
HT7D373	192
HT7D383	192
HT7D702	201
HT7D704	201
HT7D706	201
HT7D712	201
HT7D713	201
HT7D716	201
HT7D722	202
HT7D724	202
HT7D732	202
HT7D734	202
HT7D738	202
HT7D915	186
HT7D916	186
HT7D917	186
HT7D918	186
HT7D923	186
HT7D924	186
HT7D925	186
HT7D929	186
HT7D930	186
HT7D931	186
HT7D933	186
HT7D934	186
HT7D937	186
HT7D938	186
HT7D941	186
HT7D942	186
HT7D945	186
HT7D950	186
HT7D955	186
HT7D956	186
HT7D960	186
HT7D961	186
HT7D964	186
HT7D965	186
HT7D973	186
HT7G010	229
HT7G011	229
HT7G012	229
HT7G018	229
HT7G022	231
HT7G024	231
HT7G026	231
HT7G033	231
HT7G034	231
HT7G045	218
HT7G046	218
HT7G047	218
HT7G048	218
HT7G049	218
HT7G050	218
HT7G052	220
HT7G055	220
HT7G056	220
HT7G058	220
HT7G059	220
HT7G061	229
HT7G063	229

HT7G066	231
HT7G072	228
HT7G074	228
HT7G075	228
HT7G077	228
HT7G078	228
HT7G080	227
HT7G081	228
HT7G120	220
HT7G121	221
HT7G122	221
HT7G123	221
HT7G124	221
HT7G126	221
HT7G127	221
HT7G128	222
HT7G129	222
HT7G130	222
HT7G131	222
HT7G132	222
HT7G133	222
HT7G134	223
HT7G135	223
HT7G136	223
HT7G137	223
HT7G139	223
HT7G141	223
HT7G142	224
HT7G144	224
HT7G145	224
HT7G146	224
HT7G147	224
HT7G148	225
HT7G149	224
HT7G150	225
HT7G151	225
HT7G152	225
HT7G153	226
HT7G154	226
HT7G155	226
HT7G157	226
HT7G158	226
HT7G159	226
HT7G160	227
HT7G161	227
HT7G162	227
HT7G163	227
HT7G164	227

**HT8**

HT8B230	194
HT8B235	194
HT8D001	199
HT8D002	199
HT8D003	199
HT8D004	199
HT8D005	199
HT8D006	199
HT8D010	199
HT8D011	199
HT8D012	199
HT8D013	199
HT8D014	199
HT8D015	199
HT8D020	199

HT8D021	199
HT8D022	199
HT8D023	199
HT8D024	199
HT8D025	199
HT8D050	199
HT8D051	199
HT8D052	199
HT8D053	199
HT8D054	199
HT8D055	199
HT8D100	199
HT8D101	199
HT8D102	199
HT8D103	199
HT8D104	199
HT8D105	199
HT8D106	199
HT8D107	199
HT8D108	199
HT8D120	199
HT8D121	199
HT8D122	199
HT8D123	199
HT8D124	199
HT8D125	199
HT8D126	199
HT8D127	199
HT8D130	199
HT8D131	199
HT8D132	199
HT8D133	199
HT8D134	199
HT8D135	199
HT8D136	199
HT8D137	199
HT8D138	199
HT8D140	199
HT8D141	199
HT8D142	199
HT8D143	199
HT8D144	199
HT8D145	199
HT8D146	199
HT8D147	199
HT8D148	199
HT8D149	199
HT8D150	199
HT8D190	201
HT8D200	199
HT8D210	201
HT8G004	98
HT8G006	98
HT8G022	98
HT8G024	98
HT8G052	98
HT8G053	98
HT8G056	98
HT8G100	98
HT8G200	102
HT8G201	102
HT8G202	102
HT8G203	102
HT8G205	102

HT8G206	102
HT8G207	102
HT8G208	102
HT8G210	102
HT8G211	102
HT8G212	102
HT8G213	102
HT8G215	102
HT8G216	102
HT8G217	102
HT8G218	103
HT8G225	103
HT8G226	103
HT8G227	104
HT8G228	104
HT8G229	104
HT8G230	103
HT8G231	103
HT8G232	103
HT8G240	103
HT8G241	103
HT8G242	103
HT8G245	100
HT8G246	100
HT8G247	102
HT8G248	102
HT8G250	103
HT8G251	103
HT8G252	108
HT8G253	104
HT8G254	102
HT8G255	102
HT8G256	102
HT8G257	102
HT8G258	104
HT8G301	106
HT8G302	106
HT8G303	106
HT8G304	106
HT8G305	106
HT8G307	106
HT8G310	98
HT8G311	98
HT8G314	98
HT8G315	99
HT8G316	99
HT8G	



**HÖGERT**  
technik

DE Mechanische Werkzeuge  
EN Mechanical Tools  
FR Outils Mécaniques  
ES Herramientas Mecánicas  
HR Mehanički Alati  
HU Mechanikus Szerszámok  
RO Unelte Mecanice  
BG Механични Инструменти



DE Doppelring Ratschen Steckschlüssel mit Ersatzteilen EN Double ratchet wrench with sockets FR Clé à cliquet double réversibles avec jeux de douilles ES Llave de tubo de trinquete de doble cabezal HR Okasti ključ s čegrtaljkom s nastavcima HU Racsnis kulcskészlet RO Set chei cu clichet BG Ключ звездогаечен с тресчотка



- 8, 9, 10, 11, 12, 13, 15, 16, 17, 18 mm
- 14, 19 mm



x11 72T CrV

HT1R490	14 x 19 mm	5	20
---------	------------	---	----

DE Werkzeugsatz EN Tool set FR Kit d'outils ES Set de herramientas HR Garnitura alata HU Szerszámkészlet RO Trusa de scule BG Комплект инструменти



- 1/4": 10, 11, 12, 13, 14, 15, 16, 17, 18, 19, 21, 22, 24 mm
- 19 mm
- 1/4", 3/8"
- 80, 150 mm



mm	10	11	12	13	14	15	16	18	19	21	22	24
inch	3/8	7/16	15/32	1/2		19/32	5/8		3/4	13/16	7/8	15/16
star	E12	E14	E16		E18		E20	E22	E24			

x18 19 mm SPLINE GO-THROUGH 60T CrV CrMo ERGO TRAY

HT1R478	19 mm	1	8
---------	-------	---	---

DE Doppelring Ratschen Steckschlüssel mit Ersatzteilen EN Double ratchet wrench with sockets FR Clé à cliquet double réversibles avec jeux de douilles ES Llave de tubo de trinquete de doble cabezal HR Okasti ključ s čegrtaljkom s nastavcima HU Racsnis kulcskészlet RO Set chei cu clichet BG Ключ звездогаечен с тресчотка и вложки



- 8, 9, 10, 11, 12, 13, 15, 16, 17, 18 mm
- E8, E10, E11, E12, E14, E16, E18, E20, E22 mm
- 14, 19 mm



x20 72T CrV

HT1R492	14 x 19 mm	5	20
---------	------------	---	----

DE Werkzeugsatz EN Tool set FR Kit d'outils ES Set de herramientas HR Garnitura alata HU Szerszámkészlet RO Trusa de scule BG Комплект инструменти



- 1/2": 8, 10, 11, 12, 13, 14, 15, 16, 17, 18, 19, 21, 22, 24, 27, 30, 32 mm
- Universal joint
- 3 way Adapter
- 75, 254 mm
- 72T
- 16/21 mm



x24 1/2" AS SYSTEM 72T CrMo CrV

HT1R410	1/2"	1	4
---------	------	---	---

DE Werkzeugsatz EN Tool set FR Kit d'outils ES Set de herramientas HR Garnitura alata HU Szerszámkészlet RO Trusa de scule BG Комплект инструменти



- 1/2": 8, 9, 10, 11, 12, 13, 14, 15, 16, 17, 18, 19, 20, 22, 24, 27, 30, 32, 36 mm
- 15, 17, 19 mm
- 16, 21 mm
- 125, 250 mm
- Universal joint
- 3 way Adapter
- 1/2"



x29 1/2" AS SYSTEM 6 PT 72T CrMo ERGO TRAY

HT1R480	1/2"	1	4
---------	------	---	---

DE Werkzeugsatz EN Tool set FR Kit d'outils ES Set de herramientas HR Garnitura alata HU Szerszámkészlet RO Trusa de scule BG Комплект инструменти



- 1/4": 4, 4.5, 5, 5.5, 6, 7, 8, 9, 10, 11, 12, 13 mm
- SL4, SL5.5, SL7 mm
- PH1, PH2, PH3, PZ1, PZ2, PZ3
- T15, T20, T25
- H3, H4, H5, H6, H7, H8 mm;
- 150 mm
- 72T
- 75 mm
- Universal joint



x34 1/4" AS SYSTEM 6 PT 72T CrV S2 ERGO TRAY

HT1R464	1/4"	1	8
---------	------	---	---

DE Doppel Ratschenringschlüssel mit Gelenk mit Ersatzteilen EN Flexible double ratchet wrench with sockets FR Clés à douille et cliquets double réversibles avec jeux de douilles ES Llave combinada de trinquete flexible HR Okasti ključ s čegrtaljkom i zglobom s nastavcima HU Csukslós fejú kombinált racsnis kulcs RO Cheie combinata cu clichet, articulata BG Ключ звездогаечен с тресчотка с подвижна глава и вложки



- SL3, SL5, SL7 mm
  - ⊕ PH1, PH2, PH3
  - ⊕ PZ1, PZ2, PZ3
  - H2, H3, H4, H5, H6 mm
  - T15, T20, T25, T30, T40
  - ▲ 2, 3
  - ⊖ 4, 6, 8
- 1/4"
  - 8, 9, 10, 11, 12, 13, 15, 16, 17, 18 mm
  - 14, 19 mm



x36 FLEXIBLE HEAD 72T CrV

HT1R491	14 x 19 mm	5	20
---------	------------	---	----

DE Werkzeugsatz EN Tool set FR Kit d'outils ES Set de herramientas HR Garnitura alata HU Szerszámkészlet RO Trusa de scule BG Комплект инструменти



- 3/8": 6, 7, 8, 9, 10, 11, 12, 13, 14, 15, 16, 17, 18, 19, 20, 21, 22, 24 mm
- 8, 9, 10, 11, 12, 13, 14, 15, 16, 17, 18, 19 mm
- 72T
- 43, 100, 200 mm
- Universal joint
- Sliding adapter



x36 3/8" AS SYSTEM 6 PT 72T CrV S2 CrMo ERGO TRAY

HT1R465	3/8"	1	4
---------	------	---	---

DE Werkzeugsatz EN Tool set FR Kit d'outils ES Set de herramientas HR Garnitura alata HU Szerszámkészlet RO Trusa de scule BG Комплект инструменти



- Bits 10 mm
- length 30 mm:
  - ⊕ PH2, PH3
  - T20, T25, T30, T40, T45, T50, T55, T60
  - M5, M6, M8, M10, M12
  - H4, H5, H6, H8, H10, H12 mm
- length 75 mm:
  - T25, T27, T30, T40, T45, T50, T55
  - H5, H6, H7, H8, H10 mm
- length 120 mm:
  - T45, T50, T55
- 10 mm bits



x37 72T CrMo S2 PH SPLINE TORX HEX

HT1R466	10 mm	1	8
---------	-------	---	---

DE Werkzeugsatz EN Tool set FR Kit d'outils ES Set de herramientas HR Garnitura alata HU Szerszámkészlet RO Trusa de scule BG Комплект инструменти



- 1/4": 5, 5, 6, 7, 8, 9, 10, 11, 12, 13, 14 mm
- SL3, SL4, SL5, SL6 mm
- ⊕ PH1, PH2 x 2, PH3
- ⊕ PZ1, PZ2, PZ3
- ⊕ TT10, TT15, TT20, TT25, TT27, TT30, TT40
- H3, H4, H5, H6 mm
- 150 mm
- 72T
- 50, 100 mm
- Universal joint
- 1/4"



x38 1/4" AS SYSTEM 72T CrMo S2 CrV ERGO TRAY

HT1R462	1/4"	5	20
---------	------	---	----

DE Schraubenzieherspitzen im Set EN Screwdriver bits set FR Coffret d'embouts ES Set de puntas de atornillar, caja de metal HR Garnitura bitova odvijača HU Szerszámkészlet RO Trusa de scule BG Комплект битове



- 3/8": 30 mm: T20, T25, T30, T40, T45, T50, T55
- 75 mm: T20, T25, T30, T40, T45, T50, T55
- 30 mm: M5, M6, M8, M10, M12
- 75 mm: M5, M6, M8, M10, M12
- 30 mm: H4, H5, H6, H7, H8, H10, H12
- 75 mm: H4, H5, H6, H7, H8, H10, H12
- 10 mm, 3/8"
- 10 mm, 1/2"



x40 S2 3/8" 1/2" TORX SPLINE HEX

HT1S405	3/8", 1/2"	1	10
---------	------------	---	----

DE Schraubenzieherspitzen im Set EN Screwdriver bits set FR Coffret d'embouts ES Set de puntas de atornillar, caja de metal HR Garnitura bitova odvijača HU Szerszámkészlet RO Trusa de scule BG Комплект битове



- 3/8": 30 mm: T20, T25, T30, T40, T45, T50, T55
- 75 mm: T20, T25, T30, T40, T45, T50, T55
- 30 mm: M5, M6, M8, M10, M12
- 75 mm: M5, M6, M8, M10, M12
- 30 mm: H4, H5, H6, H7, H8, H10, H12
- 75 mm: H4, H5, H6, H7, H8, H10, H12
- 10 mm, 3/8"
- 10 mm, 1/2"



x40 CrV 3/8" 1/2" TORX SPLINE HEX

HT1S404	3/8", 1/2"	1	10
---------	------------	---	----

DE Werkzeugsatz EN Tool set FR Kit d'outils ES Set de herramientas HR Garnitura alata HU Szerszámkészlet RO Trusa de scule BG Комплект инструменти

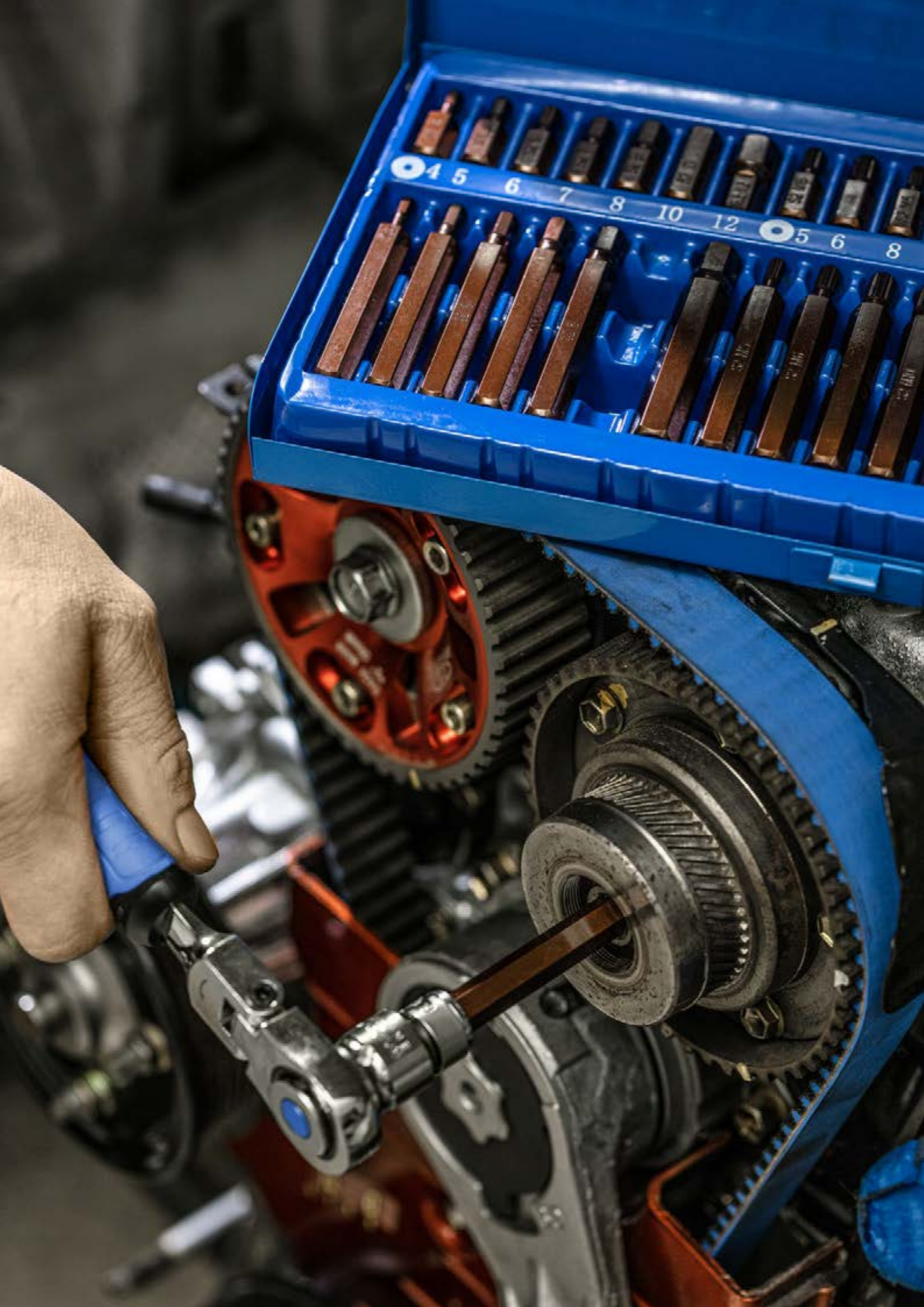

- 1/4":**
- 4, 4.5, 5, 5.5, 6, 7, 8, 9, 10, 11, 12, 13, 14 mm
  - 6, 7, 8, 9, 10, 11, 12, 13 mm
  - E4, E5, E6, E7, E8
  - 1/4" x 1/4"
  - 1/4" 75 mm
  - 150 mm
  - 1/4", 115 mm
  - 150 mm
  - 150 mm
  - Universal Joint:
  - SL3; SL4, SL4.5; SL5; SL5.5; SL6; SL7
  - PH0, PH1, PH2, PH3, PH4
  - P20, PZ1, PZ2, PZ3, PZ4
  - H1.5; H2; H2.5; H3, H4, H5, H6
  - T10; T15, T20; T25; T27; T30
  - 72T

- 3/8":**
- 13, 14, 15, 16, 17, 18, 19 mm
  - 13, 14, 15 mm
  - E10, E11, E12, E14, E16, E18
  - 3/8 F x 1/4 M
  - 150 mm
  - Universal Joint
  - 72T

- 1/2":**
- 20, 21, 22, 24, 27, 30, 32 mm
  - 15, 17, 19 mm
  - E20, E22, E24
  - 16, 21 mm
  - 127, 254 mm
  - 3 way Adapter
  - Universal Joint
  - 72T

- 180 mm
- 160 mm
- 300 g
- Combination spanner: 8, 9, 10, 11, 12, 13, 14, 15, 16, 17, 18, 19 mm
- HEX keys: 1.5, 2, 2.5, 3, 4, 5, 6, 8, 10 mm
- Adjustable wrench: 250 mm
- Voltage tester: 110-250V
- Screwdrivers 2 pcs.: PH2 x 100 mm, SL6 x 100 mm
- Cutter: 175 mm
- Utility knife: 18 mm
- Magnetic holder

x131 1/4" 3/8" 1/2" AS SYSTEM 72T CrMo CrV

HT1R439	10 mm	1	8

DE Werkzeugsatz EN Tool set FR Kit d'outils ES Set de herramientas HR Garnitura alata HU Szerszámkészlet RO Trusa de scule BG Комплект инструменти

DE Werkzeugsatz EN Tool set FR Kit d'outils ES Set de herramientas HR Garnitura alata HU Szerszámkészlet RO Trusa de scule BG Комплект инструменти

DE Werkzeugsatz EN Tool set FR Kit d'outils ES Set de herramientas HR Garnitura alata HU Szerszámkészlet RO Trusa de scule BG Комплект инструменти

DE Werkzeugsatz EN Tool set FR Kit d'outils ES Set de herramientas HR Garnitura alata HU Szerszámkészlet RO Trusa de scule BG Комплект инструменти



- 1/4":
- SL4, SL5.5, SL7
  - PH1, PH2, PH3
  - PZ1, PZ2, PZ3
  - T10, T15, T20, T25, T27, T30, T40
  - H3, H4, H5, H6, H7, H8
  - 4, 4.5, 5, 5.5, 6, 7, 8, 9, 10, 11, 12, 13, 14 mm
  - 72T
  - 50/100 mm
  - 150 mm
  - 30 mm
  - 150 mm
  - 1/4"
  - Universal joint
  - 1.27, 1.5, 2, 2.5 mm

- 1/4":
- 4, 4.5, 5, 5.5, 6.7, 8, 9, 10, 11, 12, 13 mm
  - 1/4"
  - 72T
  - 150 mm
  - 100 mm
  - Universal joint
  - PH1, 2 x PH2, PH3
  - PZ1, PZ2, PZ3
  - SL3, SL4, SL5, SL5.5 mm
  - H3, H4, H5, H6, H8
  - TT8, TT10, TT15, TT20, TT25, TT27, TT30, TT40
  - M5, M6, M8
  - 1, 2, 3
  - 6, 8, 10
  - 1.5, 2.0, 2.5 mm

- 1/4":
- 5, 5.5, 6, 7, 8, 9, 10, 11, 12, 13 mm
  - Universal joint
  - 75 mm
  - 1/4"
  - 150 mm
  - 110 mm
  - 1/4"
  - 1/4"
  - PH1, PH2, PH3
  - SL4.5 SL6.5 SL8
  - H3, H4, H5, H6
  - T10, T15, T20, T25, T27, T30, T40
- 1/2":
- 8, 9, 10, 11, 12, 13, 14, 15, 16, 17, 18, 19, 21, 22, 24, 27, 30, 32 mm
  - 16, 21 mm
  - Universal joint
  - 125, 250 mm
  - 1/2", 250 mm
  - 72T

- 1/4":
- 4, 4.5, 5, 5.5, 6, 7, 8, 9, 10, 11, 12, 13, 14 mm
  - 4, 4.5, 5, 5.5, 6, 7, 8, 9, 10, 11, 12, 13, 14 mm
  - E4, E5, E6, E7, E8, E10
  - 50, 100, 150 mm
  - 140 mm
  - 110 mm
  - Universal joint
  - 150 mm
  - 72T
  - 1/4"
  - SL4, SL5.5, SL7
  - PZ1, PZ2, PZ3
  - PH1, PH2, PH3
  - T8, T10, T15, T20, T25, T30, T40
  - H3, H4, H5, H6, H7, H8

mm	5,5	6	8	10	11	12	13	14	15	16	18	19	21	22	24	27	30	32
inch	7/32	5/16	3/8	7/16	15/32	1/2			19/32	5/8		3/4	13/16	7/8	15/16	1,1/16	1,1/8	1,1/4
star	E8	E10	E12	E14	E16	E18			E20	E22	E24							

x47 1/4" AS SYSTEM  
72T CrMo CrV

HT1R416 1/4" 1 10

x53 1/4" AS SYSTEM 72T  
CrV CrMo ERGO TRAY

HT1R485 1/4" 1 10

x60 SPLINE 1/4" 1/2" 72T  
CrV S2 ERGO TRAY

HT1R470 1/4", 1/2" 1 3

x63 1/4" AS SYSTEM  
72T CrMo CrV

HT1R486 1/4" 1 4

DE Werkzeugsatz EN Tool set FR Kit d'outils ES Set de herramientas HR Garnitura alata HU Szerszámkészlet RO Trusa de scule BG Комплект инструменти

DE Werkzeugsatz EN Tool set FR Kit d'outils ES Set de herramientas HR Garnitura alata HU Szerszámkészlet RO Trusa de scule BG Комплект инструменти

DE Werkzeugsatz EN Tool set FR Kit d'outils ES Set de herramientas HR Garnitura alata HU Szerszámkészlet RO Trusa de scule BG Комплект инструменти

DE Werkzeugsatz EN Tool set FR Kit d'outils ES Set de herramientas HR Garnitura alata HU Szerszámkészlet RO Trusa de scule BG Комплект инструменти



- 1/4":**
- 4, 4.5, 5, 5.5, 6, 7, 8, 9, 10, 11, 12, 13, 14 mm
  - 50, 100 mm
  - 150 mm
  - Universal Joint
  - 152 mm
  - 1/4" bits
  - 72T
  - 150 mm
  - SL 4, SL 5.5, SL 7
  - PH1, PH2
  - PZ1, PZ2
  - T8, T10, T15, T20, T25, T30
  - H3, H4, H5, H6
- 5/16":**
- SL 8, SL 10, SL 12
  - PH3, PH4
  - PZ3, PZ4
  - T40, T45, T50, T55
  - H8, H10, H12, H14
- 1/2":**
- 14, 15, 16, 17, 18, 19, 20, 22, 24, 27, 30, 32 mm
  - 125, 250 mm
  - 3 way adapter
  - Universal Joint
  - 16, 21 mm
  - 5/16"
  - 72T
  - 8, 10, 11, 12, 13, 14, 17, 19, 22 mm
  - 1.5, 2.0, 2.5 mm

- 1/4":**
- 4, 4.5, 5, 5.5, 6, 7, 8, 9, 10, 11, 12, 13, 14 mm
  - 150 mm
  - 115 mm
  - 50, 100 mm
  - 72T
  - SL4, SL5, SL5.5, SL6, SL8 mm
  - PH1, PH2
  - PZ1, PZ2
  - T8, T10, T15, T20x2, T25x2, T27, T30
  - TT8, TT10, TT15, TT20, TT25, TT27, TT30
  - H3, H4, H5, H6
  - TH3, TH4, TH5, TH6
  - 1, 2, 3
  - 6, 8, 10
  - M5, M6, M8
  - 1, 2
  - 1/4"
- 1/2":**
- 10, 11, 12, 13, 14, 15, 16, 17, 18, 19, 20, 21, 22, 24, 27, 30, 32, 36 mm
  - 3 way adapter
  - 254 mm
  - 72T
  - 1.27, 1.5, 2.0, 2.5, 3.0 mm

- 1/4":**
- 4, 5.5, 7 mm
  - PH1, PH2
  - PZ1, PZ2
  - T8, T10, T15, T20, T25, T30
  - H3, H4, H5, H6
  - 4, 4.5, 5, 5.5, 6, 7, 8, 9, 10, 11, 12, 13, 14 mm
  - 6, 7, 8, 9, 10, 11, 12, 13 mm
  - 72T
  - 50, 100 mm
  - 150 mm
  - 30 mm
  - 150 mm
  - 115 mm
  - Universal joint
- 5/16":**
- 8, 10, 12
  - PH3, PH4
  - PPZ3, PZ4
  - T40, T45, T50, T55
  - H8, H10, H12, H14
- 1/2":**
- 10, 11, 12, 13, 14, 15, 16, 17, 18, 19, 20, 21, 22, 24, 27, 30, 32 mm
  - 14, 15, 17, 19 mm
  - 72T
  - 125, 250 mm
  - 16, 21 mm
  - 3 Way Adapter
  - 5/16"
  - Universal Joint
  - 1.5, 2, 2.5, 3 mm

- 1/4":**
- 4, 5.5, 7
  - PH1, PH2
  - PZ1, PZ2
  - TT8, T10, T15, T20, T25, T27, T30
  - H3, H4, H5, H6
  - 4, 4.5, 5, 5.5, 6, 7, 8, 9, 10, 11, 12, 13, 14 mm
  - 6, 7, 8, 9, 10, 11, 12, 13 mm
  - E10, E11, E12, E14, E16, E18, E20, E24
  - 72T
  - 50, 100 mm
  - 150 mm
  - H30 mm
  - 150 mm
  - 115 mm
  - Universal joint
- 1/2":**
- 8, 10, 12
  - PH3, PH4
  - PZ3, PZ4
  - T40, T45, T50, T55, T60
  - H7, H8, H10, H12, H14
  - 10, 11, 12, 13, 14, 15, 16, 17, 18, 19, 20, 21, 22, 23, 24, 27, 30, 32 mm
  - 14, 15, 17, 19, 22 mm
  - E10, E11, E12, E14, E16, E18, E20, E24
  - 72T
  - 125, 250 mm
  - 16, 21 mm
  - 3 way adapter
  - Universal Joint
  - 1.27, 1.5, 2, 2.5 mm

x85 1/4" 1/2" AS SYSTEM  
72T CrMo CrV

HT1R425 1/4", 1/2" 1 4

x89 1/4" 1/2" AS SYSTEM  
72T CrMo CrV

HT1R424 1/4", 1/2" 1 4

x95 1/2" 5/16" 1/4" AS SYSTEM  
72T CrMo CrV

HT1R426 1/2", 5/16", 1/4" 1 4

x112 1/4" 1/2" AS SYSTEM  
72T CrMo CrV

HT1R432 1/4", 1/2" 1 4

DE Werkzeugsatz EN Tool set FR Kit d'outils ES Set de herramientas HR Garnitura alata HU Szerszámkészlet RO Trusa de scule BG Комплект инструменти

DE Werkzeugsatz EN Tool set FR Kit d'outils ES Set de herramientas HR Garnitura alata HU Szerszámkészlet RO Trusa de scule BG Комплект инструменти



- 1/4":**
- 4, 4.5, 5, 5.5, 6, 7, 8, 9, 10, 11, 12, 13, 14 mm
  - 6, 7, 8, 9, 10, 11, 12, 13 mm
  - SL4, SL5.5, SL7
  - PH1, PH2
  - PZ1, PZ2
  - T8, T10, T15, T20, T25, T30
  - H3, H4, H5, H6
  - 150 mm
  - 115 mm
  - 50, 100 mm
  - Universal Joint
  - 150 mm
  - Bit holder
  - 72T
  - Hex key: 1.27x2, 1.5x2, 2.0x2, 2.5, 3.0 mm

- SL4, SL5, SL5.5, SL6, SL8
  - PH1, PH2
  - PZ1, PZ2
  - T8, T10, T15, T20x2, T25x2, T27, T30
  - TT8, TT10, TT15, TT20, TT25, TT27, TT30
  - H3, H4, H5, H6
  - TH3, TH4, TH5, TH6
  - TRI-WING: 1, 2, 3
  - TORQ: 6, 8, 10
  - SPLINE: M5, M6, M8
  - SQUARE: 1, 2
  - Bit adapter: 1/4"
- 5/16":**
- 1/2" x 5/16"
  - SL8, SL10, SL12
  - PH3, PH4

- PZ3, PZ4
  - T40, T45, T50, T55
  - H8, H10, H12, H14
- 1/2":**
- 10, 11, 12, 13, 14, 15, 16, 17, 18, 19, 20, 21, 22, 24, 27, 30, 32, 36 mm
  - 14, 15, 17, 19 mm
  - 16/21 mm
  - Universal Joint
  - 3 way Adapter
  - 125, 245 mm
  - 72T

- 1/4":**
- 4, 4.5, 5, 5.5, 6, 7, 8, 9, 10, 11, 12, 13, 14 mm
  - D4, 5, 6, 7, 8, 9, 10 mm
  - 50, 100 mm
  - E4, E5, E6, E7, E8
  - Universal Joint
  - 115 mm
  - 72T
  - Hex Key Wrench: 1.27 mm x 2, 1.5 mm x 2, 2 mm x 2, 2.5 mm x 2, 3 mm x 2, 4 mm x 2, 5 mm
- 3/8":**
- 10, 11, 12, 13, 14, 15, 16, 17, 18, 19 mm
  - 10, 11, 12, 13, 14, 15 mm
  - E8, E10, E12, E14, E16
  - 18 mm
  - 125 mm
  - Universal Joint
  - 5/16"
  - 72T

- 1/2":**
- 10, 11, 12, 13, 14, 15, 17, 19, 20, 21, 22, 24, 27, 30, 32 mm
  - 16, 17, 18, 19, 22 mm
  - E18, E20, E22, E24
  - 16, 21 mm
  - 125, 250 mm
  - Universal Joint
  - 3 way Adapter
  - Bits Socket: T55, T60
  - 72T
  - 8, 9, 10, 11, 12, 13, 14, 15, 16, 17, 18, 19 mm
  - 5/16"
  - Bits holder
  - 150 mm
  - 150
  - SL4, SL5.5, SL6.5, SL7 mm
  - PH1, PH2, PH3
  - PZ1, PZ2, PZ3
  - T8, T9, T10, T15, T20, T25, T27, T30
  - TT8, TT9, TT10, TT15, TT20, TT25, TT27, TT30
  - H3, H4, H5, H6
  - Bits 30 mm:

- T25, T27x2, T30x2, T35x2, T40x3, T45x2, T50x2
- H5.5, H6 x2, H7, H8
- SL6, SL6.5, SL8
- PH3, PH4
- PZ3, PZ4
- M5, M6, M8, M10
- Bits 25 mm:
- H3, H4, H5, H6
- H3, H4, H5, H6 (with hole)
- PH1, PH2
- PZ1, PZ2
- T8, T10, T15, T20, T25, T30, T40
- TT8, TT10, TT15, TT20, TT25, TT30, TT40
- M5, M6, M8
- SL4, SL5, SL6, SL8
- TRI. WING: 1, 2, 3
- TORQ: 6, 8, 10
- SQUARE: 1, 2
- SERVICE: 4, 6, 8

x144	1/4" 1/2"	AS SYSTEM	72T	CrMo	CrV
------	--------------	-----------	-----	------	-----

HT1R440	1/4", 1/2"	1	3
---------	------------	---	---

x222	1/4" 3/8" 1/2"	AS SYSTEM	72T	CrMo	CrV
------	----------------------	-----------	-----	------	-----

HT1R444	1/4", 3/8", 1/2"	1	2
---------	------------------	---	---

DE Steckschlüsselsatz mit Umschaltknarre EN Sockets set with ratchet handle FR Jeu de douilles + cliquet ES Juego llaves de vasos + carraca HR Račna s nasadnim ključevima HU Racsnis behajtó kar dugókulcsokkal RO Clichet cu chei tubulare BG Комплект тресчотка и вложки



Ratchet 1/2"  
Sockets: 4, 5, 6, 7, 8, 9, 10,  
11, 12, 13 mm



x10 1/2" 72 T CrV CrMo

QUICK RELEASE ERGO GRIP

HT1R332	1/2"	5	10

DE Steckschlüsselsatz mit Umschaltknarre EN Sockets set with ratchet handle FR Jeu de douilles + cliquet ES Juego llaves de vasos + carraca HR Račna s nasadnim ključevima kodiranim bojom HU Racsnis behajtó kar színkódos dugókulcsokkal RO Clichete cu chei tubulare cu cod color BG Комплект тресчотка и вложки



Ratchet 1/2"  
Sockets: 10, 11, 12, 13, 14,  
15, 17, 19, 22, 24 mm



x10 1/2" 72 T CrV CrMo

QUICK RELEASE ERGO GRIP

HT1R382	1/2"	5	20

DE Umschaltknarre mit Gelenkkopf EN Swivel Ratchet handle FR Poignée à cliquet pivotant ES Llave de carraca con mango giratorio HR Račna s okretnom ručicom HU Forgókaros racsnis behajtó kar RO Clichet cu maner rotativ BG Реверсивна тресчотка

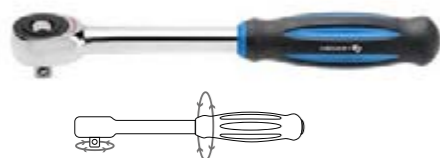

1/4" 60 T CrV CrMo

QUICK RELEASE ERGO GRIP

HT1R374	1/4"	10	50
HT1R372	1/2"	5	20

DE Umschaltknarre EN Ratchet handle FR Poignée à cliquet ES Llave de carraca HR Račna HU Racsnis behajtó kar RO Maner cu clichet BG Тресчотка



1/4" 3/8" 1/2" 72 T CrV

QUICK RELEASE ERGO GRIP

HT1R324	1/4"	10	50
HT1R328	3/8"	5	30
HT1R322	1/2"	5	25

DE Steckschlüsselsatz mit Umschaltknarre EN Sockets set with ratchet handle FR Jeu de douilles + cliquet ES Juego llaves de vasos + carraca HR Račna s nasadnim ključevima HU Racsnis behajtó kar dugókulcsokkal RO Clichet cu chei tubulare BG Комплект тресчотка и вложки



Ratchet 1/4"  
Sockets: 4, 5, 6, 7, 8, 9, 10,  
11, 12, 13 mm



x10 1/4" 72 T CrV CrMo

QUICK RELEASE ERGO GRIP

HT1R334	1/4"	5	20

DE Ring Ratschen Steckschlüssel Mit Teile EN Flexible head ratchet wrench with adapters FR Clé à douille à cliquet ES Llave De Trinquete HR Čegrtaljka s adapterima HU Ratchet csavarkulcs RO Cheie cu clichet BG Тресчотка с адаптори



x5 1/4" x19mm 3/8" x19mm 1/2" x19mm

72 T CrV FLEXIBLE HEAD

HT1R395	1/4", 3/8", 1/2"	8	48

DE Umschaltknarre EN Ratchet handle FR Poignée à cliquet ES Llave de carraca HR Račna HU Racsnis behajtó kar RO Maner cu clichet BG Тресчотка



1/4" 3/8" 1/2" 72 T CrV CrMo

QUICK RELEASE ERGO GRIP STRAIGHT

HT1R304	1/4"	10	100
HT1R308	3/8"	10	50
HT1R302	1/2"	10	30

DE Umschaltknarre EN Ratchet handle FR Poignée à cliquet ES Llave de carraca HR Račna HU Racsnis behajtó kar RO Maner cu clichet BG Тресчотка



1/4" 1/2" 72 T TPR CrMo

QUICK RELEASE ERGO GRIP

HT1R354	1/4"	12	72
HT1R352	1/2"	6	24





DE Teleskop-Umschaltknarre EN Telescopic ratchet handle FR Clé à Douille à Cliquet télescopique ES Llave de carraca telescópica HR Teleskopska račna HU Teleszkópos racsnis beható kar RO Clichet telescopic BG Телескопична тресчотка



25 YEAR WARRANTY

1/2" 72 T 300-450 mm CrV

CrMo QUICK RELEASE ERGO GRIP

HT1R342	1/2"	5	25
---------	------	---	----

DE Umschaltknarre EN Ratchet handle FR Poignée à cliquet ES Llave de carraca HR Račna HU Racsnis beható kar RO Maner cu clichet BG Тресчотка



25 YEAR WARRANTY

1/4" 72 T CrV CrMo ERGO GRIP

HT1R391	1/4"	10	100
---------	------	----	-----

DE Drehmomentschlüssel EN Torque wrench FR Clé dynamométrique ES Llave dinamométrica HR Momentni kluč HU Nyomaték kulcs RO Cheie dinamometrica BG Ключ динамометричен



24 T ±4% CrV

HT1W701	1/4"	5-25 Nm	1	12
HT1W706	1/2"	20-110 Nm	1	12
HT1W707	1/2"	40-210 Nm	1	12
HT1W708	1/2"	50-350 Nm	1	12

DE Drehmomentschlüssel EN Torque wrench FR Clé dynamométrique ES Llave dinamométrica HR Momentni kluč HU Nyomaték kulcs RO Cheie dinamometrica BG Ключ динамометричен



72 T ±3% CrMo

HT1W710	1/4"	5-25 Nm	255 mm	1	6
HT1W711	3/8"	10-60 Nm	320 mm	1	6
HT1W712	1/2"	20-120 Nm	435 mm	1	6
HT1W713	1/2"	40-220 Nm	515 mm	1	6
HT1W714	1/2"	60-330 Nm	595 mm	1	6

DE Drehgriff Typ „T“ für Steckschlüssel und Schrauber-bits EN Sliding T-handle for sockets and screwdriver bits FR Poignée en T coulissante pour douilles et embouts ES Llave "T" para llaves de vaso y puntas para atornillar HR T-drška za nasadne ključeve i bitove odvijača HU Csúsztható T-markolat dugókulcsokhoz RO Maner glisant tip T pentru chei tubulare BG Бит държач, T - образен, регулируем



1/4" 2 in 1 S2 STEEL ADJUSTABLE

HT1W879	1/4"	1	60
---------	------	---	----

DE Spinner Griff EN Spinner handle FR Rallonge avec manche ES Destornillador para llaves de vaso HR Okretna ručka za nasadne ključeve HU Dugókulcs beható kar RO Adapter pentru chei tubulare BG Отвертка за вложки



1/4" CrV ERGO GRIP

HT1S203	150 mm	10	100
---------	--------	----	-----

DE Verlängerung für Steckschlüssel EN Extension bar FR Rallonge de clé ES Alargador HR Produžetak za nasadne ključeve HU Hosszabbító kar RO Extensie BG Удължител за вложки



25 YEAR WARRANTY

1/4" CrV DIN 3123

HT1A701	50 mm	50	500
HT1A702	76 mm	40	400
HT1A703	100 mm	25	250
HT1A705	152 mm	20	200

DE Verlängerung für Steckschlüssel EN Extension bar FR Rallonge de clé ES Alargador HR Produžetak za nasadne ključeve HU Hosszabbító kar RO Extensie BG Удължител за вложки



25 YEAR WARRANTY

3/8" CrV DIN 3123

HT1A714	127 mm	20	80
---------	--------	----	----

DE Verlängerung für Steckschlüssel EN Extension bar FR Rallonge de clé ES Alargador HR Produžetak za nasadne ključeve HU Hosszabbító kar RO Extensie BG Удължител за вложки



25 YEAR WARRANTY

1/2" CrV DIN 3123

HT1A724	125 mm	20	100
HT1A727	250 mm	10	40

DE L-Knarre für Steckschlüssel EN Handle for wrench socket L-shape FR Cle Type L ES Llave tipo L HR Okretna ručka L-tipa HU L-alakú toldó markolat RO Chei tubulare cu maner de prelungire tip L BG Г-образен върток за вложки



25 YEAR WARRANTY

1/2" CrV DIN 3122

HT1A792	250 mm	10	40
---------	--------	----	----

DE Steckschlüssel-Hebel mit Gelenk EN Flexible handle FR Rallonge de clé Flexible ES Alargador de llave flexible HR Nagibna okretna ručka HU Rugalmas markolat RO Maner flexibil BG Върток за вложка с плъзгаща дръжка



25 YEAR WARRANTY

1/2" CrV DIN 3121

HT1A763	380 mm	5	200
HT1A764	457 mm	5	200

DE Elastische Verlängerung für Steckschlüssel EN Flexible extension bar FR Rallonge de clé ES Alargador flexible HR Produžetak za nasadne ključeve, fleksibilan HU Mechanikai szerszámok RO Extensie flexibilă BG Удължител за вложки, гъвкав



25 YEAR WARRANTY

1/4" FLEXIBLE CrV

HT1A740	150 mm	20	200
---------	--------	----	-----

DE Drehgriff Typ "T" EN Sliding T-bar FR Poignée coulissante en T ES Mango deslizante en T HR Okretna ručka T-tipa HU Csúsztható T-rúd RO Bara tip T glisant BG Върток за вложка тип T



25 YEAR WARRANTY

1/4" CrV DIN 3122

HT1A745	1/4"	152 mm	25	200
HT1A747	1/2"	255 mm	10	50

DE Verlängerung für Steckschlüssel EN Universal joint FR Joint universel ES Adaptador Vaso universal HR Univerzalni spoj za nasadne ključeve HU Univerzális csatlakozó elem dugókulcsokhoz RO Legatura universala pentru chei tubulare BG Кардан за вложка



25 YEAR WARRANTY

1/4" 3/8" 1/2" CrV DIN 3123

HT1A755	1/4"	25	500
HT1A756	3/8"	20	200
HT1A757	1/2"	25	200

DE Adapter EN Socket adapter FR Adaptateur douille ES Adaptador para vasos HR Adapter HU Adapter RO Adapter BG Адаптор



25 YEAR WARRANTY

CrV DIN 3121

HT1A770	F1/4" x M3/8"	50	500
HT1A771	F3/8" x M1/4"	25	250
HT1A772	F3/8" x M1/2"	25	250
HT1A773	F1/2" x M3/8"	20	200
HT1A774	F1/2" x M3/4"	10	100
HT1A775	F3/4" x M1/2"	10	100

DE Sechskantsteckschlüssel EN Socket, hexagon metric FR Douille hexagonales ES Llave de vaso hexagonal HR Šesterokutni nasadni ključ HU Hatszög dugókulcs RO Chei tubulare hexagonale BG Вложка шестостенна

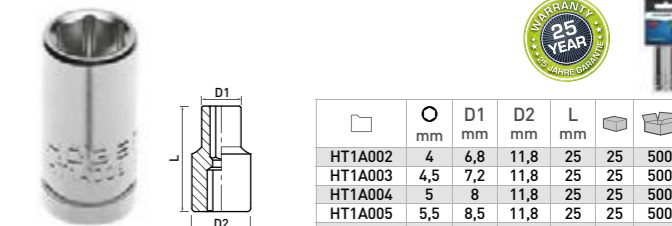

25 YEAR WARRANTY

1/4" 6 PT AS SYSTEM CrV DIN 3124

HT1A002	4	6,8	11,8	25	25	500
HT1A003	4,5	7,2	11,8	25	25	500
HT1A004	5	8	11,8	25	25	500
HT1A005	5,5	8,5	11,8	25	25	500
HT1A006	6	9,2	11,8	25	25	500
HT1A007	7	10,8	11,8	25	25	500
HT1A008	8	11,8	11,8	25	25	500
HT1A009	9	12,8	12,8	25	25	500
HT1A010	10	14,5	14,5	25	20	400
HT1A011	11	15,8	15,8	25	25	500
HT1A012	12	16,8	16,8	25	20	400
HT1A013	13	17,8	17,8	25	20	400
HT1A014	14	19,8	19,8	25	20	400

DE Sechskantsteckschlüssel lang EN Socket, hexagon metric, deep FR Douille Hexagonale allongée ES Llave de vaso hexagonal larga HR Šesterokutni nasadni ključ HU Hatszög dugókulcs RO Chei tubulare hexagonale BG Вложка шестостенна, дълга

DE Sechskantsteckschlüssel EN Socket, hexagon metric FR Douille 6 pans ES Llave de vaso hexagonal HR Šesterokutni nasadni ključ HU Hatszög dugókulcs RO Chei tubulare hexagonale BG Вложка шестостенна

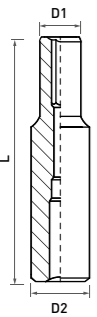

3/8" 6 PT DEEP  
AS SYSTEM CrV DIN 3124

Folder	Ø	D1	D2	L	Box	Box
HT1A156	6 mm	10,3 mm	16,8 mm	64 mm	30	240
HT1A157	7 mm	10,8 mm	16,8 mm	64 mm	30	240
HT1A158	8 mm	12 mm	16,8 mm	64 mm	30	240
HT1A159	9 mm	13,3 mm	16,8 mm	64 mm	30	240
HT1A160	10 mm	14,5 mm	16,8 mm	64 mm	30	240
HT1A161	11 mm	16,8 mm	16,8 mm	64 mm	30	240
HT1A162	12 mm	17,8 mm	17,8 mm	64 mm	30	240
HT1A163	13 mm	18,8 mm	18,8 mm	64 mm	30	240
HT1A164	14 mm	19,8 mm	19,8 mm	64 mm	25	200
HT1A165	15 mm	21,8 mm	21,8 mm	64 mm	20	160
HT1A166	16 mm	21,8 mm	21,8 mm	64 mm	20	160
HT1A167	17 mm	23,8 mm	23,8 mm	64 mm	15	120
HT1A168	18 mm	25,8 mm	25,8 mm	64 mm	15	120
HT1A169	19 mm	25,8 mm	25,8 mm	64 mm	15	120
HT1A170	20 mm	27,8 mm	27,8 mm	64 mm	10	80
HT1A171	21 mm	27,8 mm	27,8 mm	64 mm	10	80

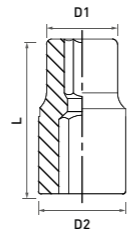

1/2" 6 PT AS SYSTEM  
CrV DIN 3124

Folder	Ø	D1	D2	L	Box	Box
HT1A208	8 mm	13,7 mm	21,8 mm	38 mm	20	200
HT1A209	9 mm	14,2 mm	21,8 mm	38 mm	20	200
HT1A210	10 mm	15,3 mm	21,8 mm	38 mm	20	200
HT1A211	11 mm	16,5 mm	21,8 mm	38 mm	20	200
HT1A212	12 mm	17,8 mm	21,8 mm	38 mm	20	200
HT1A213	13 mm	19,0 mm	21,8 mm	38 mm	20	200
HT1A214	14 mm	20,3 mm	21,8 mm	38 mm	20	200
HT1A215	15 mm	21,8 mm	20,5 mm	38 mm	20	200
HT1A216	16 mm	21,8 mm	20,5 mm	38 mm	20	200
HT1A217	17 mm	23,8 mm	21,8 mm	38 mm	20	200
HT1A218	18 mm	25,8 mm	22,8 mm	38 mm	10	200
HT1A219	19 mm	25,8 mm	22,8 mm	38 mm	10	100
HT1A220	20 mm	27,8 mm	23,8 mm	38 mm	10	100
HT1A221	21 mm	27,8 mm	23,8 mm	38 mm	20	200
HT1A222	22 mm	29,8 mm	26 mm	38 mm	10	100
HT1A223	23 mm	31,8 mm	28 mm	39 mm	20	200
HT1A224	24 mm	31,8 mm	28 mm	39 mm	10	100
HT1A227	27 mm	35,8 mm	30 mm	42 mm	5	50
HT1A230	30 mm	39,8 mm	34 mm	44 mm	5	50
HT1A232	32 mm	41,8 mm	36 mm	44 mm	5	50
HT1A236	36 mm	45,8 mm	48 mm	44 mm	5	50

DE Sechskantsteckschlüssel EN Socket, hexagon metric FR Douille 6 pans ES Llave de vaso HR Šesterokutni nasadni ključ HU Hatszög dugókulcs RO Chei tubulare hexagonale BG Вложка шестостенна

DE Steckschlüssel Spline EN Spline socket FR Douille spline 1/2", 8 mm, ES Llave de vaso Spline 1/2", 8 mm, CrV50BV30, DIN 3121 HR Nasadni ključ spline HU Spline dugókulcsok RO Chei tubulare spline BG Вложка тип Spline

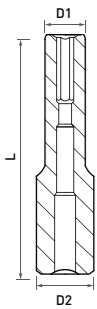

1/2" 6 PT DEEP  
AS SYSTEM CrV DIN 3124

Folder	Ø	D1	D2	L	Box	Box
HT1A258	8 mm	14,8 mm	21,8 mm	78 mm	20	160
HT1A259	9 mm	15,3 mm	21,8 mm	78 mm	20	160
HT1A260	10 mm	15,3 mm	21,8 mm	78 mm	20	160
HT1A261	11 mm	16,5 mm	21,8 mm	78 mm	20	160
HT1A262	12 mm	17,8 mm	21,8 mm	78 mm	20	160
HT1A263	13 mm	19,0 mm	21,8 mm	78 mm	15	120
HT1A264	14 mm	20,0 mm	21,8 mm	78 mm	15	120
HT1A265	15 mm	21,8 mm	21,8 mm	78 mm	15	120
HT1A266	16 mm	21,8 mm	21,8 mm	78 mm	15	120
HT1A267	17 mm	23,8 mm	23,8 mm	78 mm	15	120
HT1A268	18 mm	25,8 mm	25,8 mm	78 mm	15	120
HT1A269	19 mm	25,8 mm	25,8 mm	78 mm	15	120
HT1A270	20 mm	27,8 mm	27,8 mm	78 mm	10	80
HT1A271	21 mm	27,8 mm	27,8 mm	78 mm	10	80
HT1A272	22 mm	29,8 mm	29,8 mm	78 mm	10	80
HT1A273	23 mm	31,8 mm	31,8 mm	78 mm	10	80
HT1A274	24 mm	31,8 mm	31,8 mm	78 mm	10	80
HT1A277	27 mm	35,8 mm	35,8 mm	78 mm	8	64
HT1A280	30 mm	39,8 mm	39,8 mm	78 mm	6	48
HT1A282	32 mm	41,8 mm	41,8 mm	78 mm	6	48

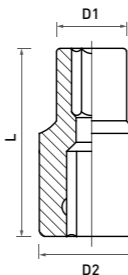

1/2" SPLINE CrV  
DIN 3124

Folder	Ø	D1	D2	L	Box	Box
HT1A408	8 mm	13,7 mm	21,8 mm	38 mm	20	200
HT1A409	9 mm	14,2 mm	21,8 mm	38 mm	20	200
HT1A410	10 mm	15,3 mm	21,8 mm	38 mm	20	200
HT1A411	11 mm	16,5 mm	21,8 mm	38 mm	20	200
HT1A412	12 mm	17,8 mm	21,8 mm	38 mm	20	200
HT1A413	13 mm	19,0 mm	21,8 mm	38 mm	20	200
HT1A414	14 mm	20,3 mm	21,8 mm	38 mm	20	200
HT1A415	15 mm	21,8 mm	20,5 mm	38 mm	20	200
HT1A416	16 mm	21,8 mm	20,5 mm	38 mm	20	200
HT1A417	17 mm	23,8 mm	21,8 mm	38 mm	20	200
HT1A418	18 mm	25,8 mm	22,8 mm	38 mm	10	100
HT1A419	19 mm	25,8 mm	22,8 mm	38 mm	10	100
HT1A420	20 mm	27,8 mm	23,8 mm	38 mm	10	100
HT1A421	21 mm	29,8 mm	26,0 mm	38 mm	10	100
HT1A422	22 mm	29,8 mm	26,0 mm	38 mm	10	100
HT1A423	23 mm	31,8 mm	28,0 mm	38 mm	10	100
HT1A424	24 mm	33,8 mm	28,5 mm	40 mm	10	100
HT1A427	27 mm	35,8 mm	30,0 mm	42 mm	5	50
HT1A430	30 mm	39,8 mm	34,0 mm	44 mm	5	50
HT1A432	32 mm	41,8 mm	36,0 mm	44 mm	5	50

DE Sechskant Zündkerzensteckschlüssel EN Hexagon spark plug socket FR Douille pour bougie ES Llave de vaso HR Nasadni ključ za svjećice HU Gyújtógyertya kulcs RO Chei pentru bujii BG Вложка шестостенна за свещи

DE Sechskant Zündkerzensteckschlüssel EN Hexagon spark plug socket FR Douille pour bougies d'allumage ES Vaso bujia HR Nasadni ključ za svjećice HU Gyújtógyertya kulcs RO Chei tubulare pentru bujii BG Вложка за свещи

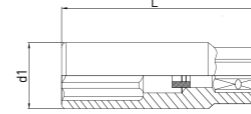

3/8" 6 PT CrV DIN 3120

Folder	Ø	D1	L	Box	Box
HT1A779	16 mm	21,8 mm	64 mm	20	160

DE Steckschlüsselsatz EN Deep socket set FR Jeu de douilles ES Llaves de vaso HR Komplet šesterokutnih nasadnih ključeva HU Hatszög dugókulcs készlet RO Set de chei tubulare hexagonale BG Комплект вложки



5,5, 6, 7, 8, 9, 10, 12, 13 mm

x8 1/4" 6 PT DEEP

AS SYSTEM CrV DIN 3124

Folder	Box	Box	Box
HT1A886	50 mm	5	40

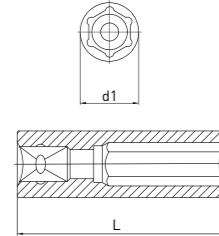

1/2" 6 PT CrV DIN 3120

Folder	Ø	D1	L	Box	Box
HT1A783	16 mm	21,8 mm	64 mm	20	200
HT1A785	21 mm	27,8 mm	65 mm	10	100

DE Steckschlüsselsatz EN Deep socket set FR Jeu de douilles ES Llaves de vaso HR Komplet šesterokutnih nasadnih ključeva HU Hatszög dugókulcs készlet RO Set de chei tubulare hexagonale BG Комплект вложки



10, 12, 13, 14, 15, 17, 19, 21, 22, 24 mm

x10 1/2" 6 PT DEEP

AS SYSTEM CrV DIN 3124

Folder	Box	Box	Box
HT1A888	76 mm	5	10

DE Sechskantsteckschlüssel EN Socket, hexagon metric FR Douille 6 pans ES Llave de vaso HR Šesterokutni nasadni ključ HU Hatszög dugókulcs RO Chei tubulare hexagonale BG Вложка шестостенна

DE Steckschlüssel Spline EN Spline socket FR Douille spline 1/2", 8 mm, ES Llave de vaso Spline 1/2", 8 mm, CrV50BV30, DIN 3121 HR Nasadni ključ spline HU Spline dugókulcsok RO Chei tubulare spline BG Вложка тип Spline

DE Spitzenset torx EN Torx bit socket set FR Kit de torx ES Juego de Llaves torx HR Komplet nasadnih ključeva torx HU Torx dugókulcs készlet RO Set de chei tubulare torx BG Комплект вложки тип torx

DE Spitzenset torx EN Torx bit socket set FR Kit de torx ES Juego de Llaves torx HR Komplet nasadnih ključeva torx HU Torx dugókulcs készlet RO Set de chei tubulare torx BG Комплект вложки тип torx



1/4": E5, E6, E7, E8  
3/8": E10, E12, E14, E16  
1/4" M x 3/8" F

x9 3/8" 1/4" TORX CrV

Folder	Box	Box	Box
HT1A884	E5-E16	5	20



1/2": E10, E11, E12, E14, E16, E18, E20, E22, E24

x9 1/2" TORX CrV

Folder	Box	Box	Box
HT1A880	E10-E24	5	20

DE Adapter für Bits EN Bit adapter FR Adaptateur de bit ES Adaptador de punta de HR Adapter za bitove HU Bitfej adapter RO Adapter pentru biti BG Адаптор за битове

DE PH Stiftschlüssel EN PH Impact bit socket FR Clef mâle PH ES Llave de vaso con punta PH HR Držac bitova PH HU PH pneumatikus bitfej készlet RO Biti de impact PH BG Бит вложка PH



1/4" CrV

Folder	Box	Box	Box
HT1A752	1/4"	25	500

PH 1/4" CrV  
S2 HRC 58-60 DIN 3120

Folder	Ø	L	Box	Box
HT1S601	PH1	37 mm	50	400
HT1S602	PH2	37 mm	50	400
HT1S603	PH3	37 mm	50	400

DE PZ Stiftschlüssel EN PH Impact bit socket FR Clef mâle PZ ES Llave de vaso con punta PZ HR Držac bitova PZ HU PZ pneumatikus bitfej készlet RO Biti de impact PZ BG Бит вложка PZ

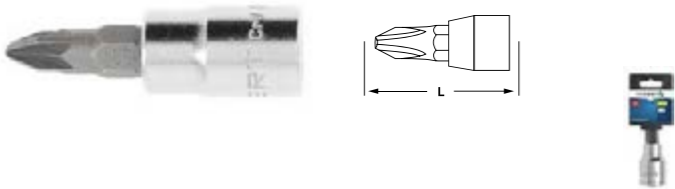

⊕ PZ 1/4" CrV  
S2 HRC 58-60 DIN 3120

Folder	Symbol	L	Hex	Box
HT1S606	PZ1	37 mm	50	400
HT1S607	PZ2	37 mm	50	400
HT1S608	PZ3	37 mm	50	400

DE Bit-Stecknüsse Hex EN Hex bit socket FR Embout de tournevis Hex ES Llave de vaso con punta hexagonal HR Držac bitova hex HU Hex bitfej kulcsok RO Biti hex BG Бит вложка HEX

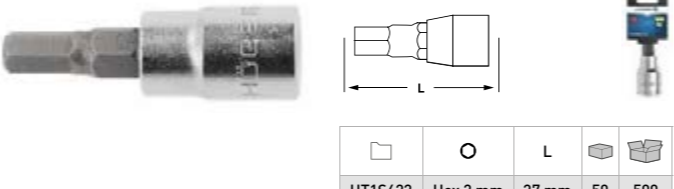

HEX 1/4" CrV S2  
HRC 58-60 DIN 3120

Folder	Symbol	L	Hex	Box
HT1S623	Hex 3 mm	37 mm	50	500
HT1S624	Hex 4 mm	37 mm	50	500
HT1S625	Hex 5 mm	37 mm	50	500
HT1S626	Hex 6 mm	37 mm	50	500
HT1S627	Hex 7 mm	37 mm	50	500
HT1S628	Hex 8 mm	37 mm	50	500

DE Torx-Stiftschlüssel EN Torx bit socket FR Clef mâle ES Llave de vaso con punta HR Držac bitova torx HU Torx bitfej dugókulcs RO Biti Torx BG Бит вложка torx

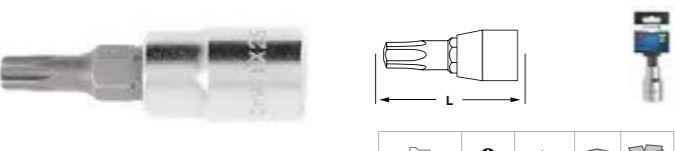

TORX 1/4" CrV S2  
HRC 58-60 DIN 3120

Folder	Symbol	L	Hex	Box
HT1S640	T8	37 mm	50	500
HT1S642	T10	37 mm	50	500
HT1S643	T15	37 mm	50	500
HT1S644	T20	37 mm	50	500
HT1S645	T25	37 mm	50	500
HT1S646	T27	37 mm	50	600
HT1S647	T30	37 mm	50	600
HT1S648	T40	37 mm	50	600
HT1S649	T45	37 mm	50	600

DE Bit-Stecknüsse Tamper-torx EN Torx security socket bit FR Embout de tournevis torx ES Llave de vaso con punta torx HR Držac bitova Tamper torx HU Tamper Torx bitfej dugókulcs RO Biti Tamper torx BG Бит вложка torx security



TAMPER TORX 1/4" CrV S2  
HRC 58-60 DIN 3120

Folder	Symbol	L	Hex	Box
HT1S670	TT6	37 mm	50	300
HT1S671	TT7	37 mm	50	300
HT1S672	TT8	37 mm	50	500
HT1S673	TT9	37 mm	50	300
HT1S674	TT10	37 mm	50	500
HT1S675	TT15	37 mm	50	500
HT1S676	TT20	37 mm	50	400
HT1S677	TT25	37 mm	50	400
HT1S678	TT27	37 mm	50	500
HT1S679	TT30	37 mm	50	400
HT1S680	TT40	37 mm	50	500

DE Sechskant-Stiftschlüssel EN Hex bit socket FR Clef mâle hex ES Llave de vaso con punta hex HR Držac bitova hex HU Hex bitfej dugókulcs RO Biti Hex BG Бит вложка HEX

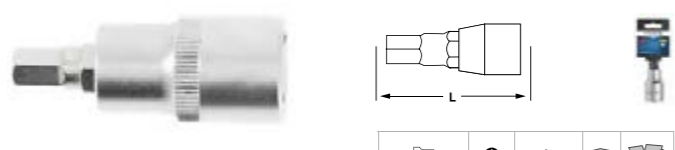

HEX 1/2" CrV S2  
HRC 58-60 DIN 3120

Folder	Symbol	L	Hex	Box
HT1S724	H4	55 mm	50	500
HT1S725	H5	55 mm	50	500
HT1S726	H6	55 mm	50	500
HT1S727	H7	55 mm	50	500
HT1S728	H8	55 mm	50	500
HT1S729	H10	55 mm	50	600
HT1S730	H12	55 mm	50	600
HT1S731	H14	55 mm	50	600
HT1S732	H17	55 mm	50	600

DE Torx-Stiftschlüssel EN Torx bit socket FR Clef mâle torx ES Llave de vaso con punta torx HR Držac bitova torx HU Torx bitfej dugókulcs RO Biti torx BG Бит вложка torx

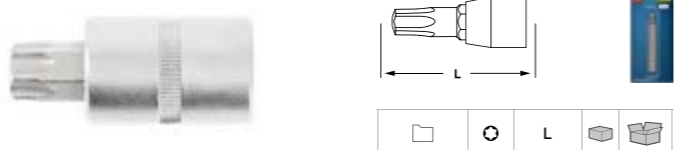

TORX 1/2" CrV S2  
HRC 58-60 DIN 3120

Folder	Symbol	L	Hex	Box
HT1S746	T20	55 mm	20	240
HT1S747	T25	55 mm	20	240
HT1S748	T27	55 mm	20	240
HT1S749	T30	55 mm	20	240
HT1S750	T40	55 mm	20	240
HT1S751	T45	55 mm	20	240
HT1S752	T50	55 mm	20	240
HT1S753	T55	55 mm	20	240
HT1S754	T60	55 mm	20	160
HT1S755	T70	55 mm	20	160

DE Spline-Stiftschlüssel EN Spline bit socket FR Clef mâle spline ES Llave de vaso con punta spline HR Držac bitova spline HU Spline bitfej dugókulcs RO Biti spline BG Бит вложка spline

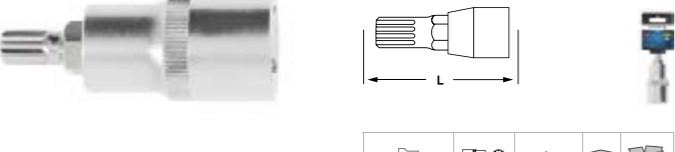

SPLINE 1/2" CrV S2  
HRC 58-60 DIN 3120

Folder	Symbol	L	Hex	Box
HT1S785	M5	55 mm	20	240
HT1S786	M6	55 mm	20	240
HT1S788	M8	55 mm	20	240
HT1S790	M10	55 mm	20	240
HT1S792	M12	55 mm	20	240
HT1S794	M14	55 mm	20	240
HT1S796	M16	55 mm	20	240
HT1S797	M17	55 mm	20	240

DE Sechskant-Stiftschlüssel EN Hex bit socket FR Clef mâle hex ES Llave de vaso con punta HR Držac bitova hex HU Hex bitfej dugókulcs RO Biti hex BG Бит вложка hex

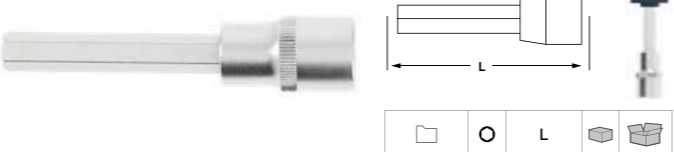

HEX 1/2" CrV S2  
HRC 58-60 DIN 3120

Folder	Symbol	L	Hex	Box
HT1S524	H4	100 mm	20	120
HT1S525	H5	100 mm	20	120
HT1S526	H6	100 mm	20	120
HT1S527	H7	100 mm	20	120
HT1S528	H8	100 mm	20	120
HT1S529	H10	100 mm	20	120
HT1S530	H12	100 mm	20	120
HT1S531	H14	100 mm	20	120
HT1S532	H17	100 mm	16	64

DE Torx-Stiftschlüssel EN Torx bit socket FR Clef mâle torx ES Llave de vaso con punta torx HR Držac bitova torx HU Torx bitfej dugókulcs RO Biti torx BG Бит вложка torx

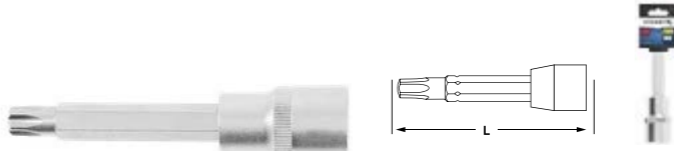

TORX 1/2" CrV S2  
HRC 58-60 DIN 3120

Folder	Symbol	L	Hex	Box
HT1S546	T20	100 mm	20	120
HT1S547	T25	100 mm	20	120
HT1S548	T27	100 mm	20	120
HT1S549	T30	100 mm	20	120
HT1S550	T40	100 mm	20	120
HT1S551	T45	100 mm	20	120
HT1S552	T50	100 mm	20	120
HT1S553	T55	100 mm	20	120
HT1S554	T60	100 mm	20	120
HT1S555	T70	100 mm	20	120

DE Spline-Stiftschlüssel EN Spline bit socket FR Clef mâle spline ES Llave de vaso con punta spline HR Držac bitova spline HU Spline bitfej dugókulcs RO Biti Spline BG Бит вложка spline

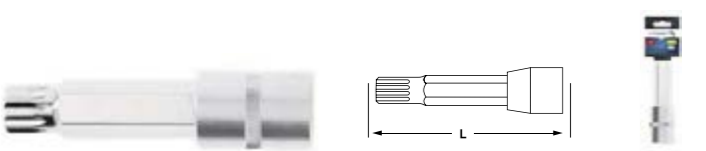

SPLINE 1/2" CrV S2  
HRC 58-60 DIN 3120

Folder	Symbol	L	Hex	Box
HT1S585	M5	100 mm	20	120
HT1S586	M6	100 mm	20	120
HT1S588	M8	100 mm	20	120
HT1S590	M10	100 mm	20	120
HT1S592	M12	100 mm	20	120
HT1S594	M14	100 mm	20	120
HT1S596	M16	100 mm	16	64
HT1S597	M17	100 mm	16	64

DE Schrauberbit-Satz EN Screwdriver bits set FR Coffret d'embouts ES Set puntas de atornillar HR Komplet bitova odvijaja HU Csavarhúzó bitfej készlet RO Set de biti surubelnita BG Комплект бит вложки



x17 1/4" S2  
HT1S401 1/4" 12 48

- ⊕ SL4, SL5, SL7 mm
- ⊕ PH0, PH1, PH2, PH3
- ⊕ PZ0, PZ1, PZ2, PZ3
- ⊙ T10, T15, T20, T25, T30
- Magnetic holder 1/4"

DE Schrauberbit-Satz EN Screwdriver bits set FR Coffret d'embouts ES Set puntas de atornillar HR Komplet bitova odvijaja HU Csavarhúzó bitfej készlet RO Set de biti surubelnita BG Комплект бит вложки



x32 1/4" SLIM S2  
HT1S400 1/4" 20 40

- ⊕ 3, 4, 5, 6
- ⊕ PH1, PH2, PH3, PH4
- ⊕ PZ1, PZ2, PZ3
- ⊙ H3, H4, H5, H6
- ⊙ T10, T15, T20, T25, T27, T30, T40
- ⊙ T10, T15, T20, T25, T27, T30, T40
- Adapter for sockets
- Magnetic handle

DE Schrauberbit-Satz EN Screwdriver bits set FR Coffret d'embouts ES Set puntas de atornillar HR Komplet bitova odvijaja HU Csavarhúzó bitfej készlet RO Set de biti surubelnita BG Комплект бит вложки



x33 1/4" SLIM S2  
HT1S402 1/4" 12 48

- ⊕ SL3, SL4, SL5, SL5.5, SL6.5 mm
- ⊕ PH1, PH2 x 2, PH3
- ⊕ PZ1, PZ2 x 2, PZ3
- ⊙ T8, T9, T10, T15 x 2, T20 x 2, T25 x 2, T30, T40
- ⊙ H2, H2.5, H3, H4, H5, H6
- Adapter for 1/4" sockets
- Magnetic holder 1/4"

DE Schrauberbit-Satz mit Ratsche EN Screwdriver bits set FR Set d'embouts de tournevis ES Juego de puntas de destornilladores HR Komplet bitova odvijaja HU Csavarhúzó bitfej készlet RO Set de biti surubelnita BG Комплект бит вложки с тресчотка



x33 1/4" SLIM S2 52T  
HT1R460 1/4" 5 50

- ⊕ 3, 4, 5, 6
- ⊕ PH1, PH2 x 2, PH3
- ⊕ PZ1, PZ2 x 2, PZ3
- ⊙ H3, H4, H5, H6
- ⊙ T10, T15, T20, T25, T27, T30, T40
- ⊙ T10, T15, T20, T25, T27, T30, T40
- Adapter for sockets
- Ratchet 1/4", 52T

DE Schrauberbit-Satz EN Screwdriver bits set FR Coffret d'embouts ES Set puntas de atornillar HR Komplet bitova odvijaja HU Csavarhúzó bitfej készlet RO Set de biti surubelnita BG Комплект бит вложки



x50 1/4" S2  
HT1R461 1/4" 5 50

- ⊕ PH0, PH1 x 2, PH2 x 2, PH3
- ⊕ PZ0, PZ1 x 3, PZ2 x 3, PZ3
- ⊕ SL3, SL4, SL5, SL6, SL7
- ⊙ T10, T15, T20, T25, T27, T30, T40
- ⊙ TT10, TT15, TT20, TT25, TT27, TT30, TT40
- ⊙ H2, H3, H4, H5, H6
- ⊙ M5, M6, M8
- Tri Wing: 1, 2, 3
- Square: S0, S1, S2, S3
- Service: 4, 6, 8

DE Bithalter EN Magnetic bit holder FR Porte-embout magnétique ES Adaptador magnético para puntas HR Magnetska ručka HU Mágneses markolat RO Maner magnetic BG Бит държач магнитен



1/4" CrV AI MAGNETIC  
HT1S438 60 mm 10 200

DE Bithalter EN Magnetic bit holder FR Porte-embout ES Adaptador para puntas HR Magnetska ručka HU Mágneses markolat RO Maner magnetic BG Бит държач магнитен



1/4" CrV MAGNETIC

Folder	Length	Width	Quantity
HT1S439	60 mm	5	250

DE Bithalter EN Magnetic bit holder FR Porte-embout ES Adaptador para puntas HR Magnetska ručka HU Mágneses markolat RO Maner magnetic BG Бит държач магнитен



1/4" CrV Al MAGNETIC

Folder	Length	Width	Quantity
HT1S440	60 mm	50	250

DE Aluminium Bithalter EN Aluminium bit holder FR Porte-embout Aluminium ES Soporte para puntas de destornillador HR SLIM Magnetska ručka HU SLIM mágneses markolat RO Maner magnetic SLIM BG Бит държач магнитен SLIM



1/4" SLIM 8.2 mm CrV Al MAGNETIC

Folder	Length	Width	Quantity
HT1S441	78 mm	10	200

DE Bohrfutter-Adapter für Nüsse EN Socket bit adapters FR Adaptateurs de douille ES Adaptador para llaves de vaso HR Ručka za nasadne ključeve HU Dugókulcs markolat RO Maner pentru biti tubulari BG Адаптор за вложки, бормашина



1/4" 1/4" 3/8" 1/2" 65 mm 75 mm CrV

Folder	Width	Length	Quantity
HT1S445	1/4" 1/4" 3/8" 1/4" 1/2"	65 mm 65 mm 75 mm	10 100



DE Aluminium Bithalter EN Aluminium bit holder FR Porte-embout ES Soporte para puntas de destornillador HR Magnetska ručka s pokretnim ovratnikom HU Mágneses adapter mozgatható peremmel RO Adapter magnetic cu flansa mobila BG Бит държач магнитен движим



1/4" CrV Al MAGNETIC

Folder	Length	Width	Quantity
HT1S442	76-118 mm	10	200



DE Adapter für Nüsse EN Socket bit adapters FR Adaptateurs de douille ES Adaptador para llaves de vaso HR Držac za nasadne ključeve HU Bithegy-tartó RO Adaptor pentru biți BG Адаптор за вложки

1/2" DRIVE END 1/4" CrV BALL-END ALU GRIP 360°

Folder	Length	Width	Quantity
HT1S446	100 mm	10	100

DE Steckschlüsseinsatz magnetisch EN Magnetic sockets FR Douilles magnétiques ES Llave de vaso imantada HR Magnetski nasadni ključ HU Mágneses dugókulcs RO Soclu magnetic BG Магнитна вложка

1/4" 48 mm x2 CrV MAGNETIC

Folder	Length	Width	Quantity
HT1S457	8 mm	10	100
HT1S458	10 mm	10	100
HT1S459	12 mm	10	100
HT1S460	13 mm	10	100

DE Gipskartonplatten Schraubendreher Spitzen PH EN Screwdriver bit, gypsum board FR Pack de embouts pour plâtre ES Pack de uds de Punta de atornillar HR Bitovi odvijača za G-K ploče HU PH2 csavarhúzó bitfejek gipszkartonhoz RO Biti surubelnita PH2 pentru gips carton BG Битове за гипскартон



PH2 1/4" x2 S2 DIN ISO 2351-2

Folder	Length	Width	Quantity
HT1S432	PH2	25 mm	10 100



DE Schraubersbits Philips PH EN Screwdriver bit FR Embouts tournevis PH ES Puntas de destornillador PH HR Bitovi odvijača PH HU PH csavarhúzó bitfejek RO Biti surubelnita PH BG Бит с магнитен държач



PH2 1/4" x2 S2 HRC 58-60 MAGNETIC DIN 3126

Folder	Length	Width	Quantity
HT1S305	PH2	65 mm	10 100



DE Schraubendreherspitzen PH EN PH screwdriver bit FR Embout PH ES Punta de atornillar PH HR Bitovi odvijača PH HU PH csavarhúzó bitfejek RO Biti surubelnita PH BG Бит накрайки PH

PH 1/4" x5 ARC anty-slip S2 HRC 58-60 DIN 3126

Folder	Length	Width	Quantity
HT1S300	PH0	25 mm	10 100
HT1S301	PH1	25 mm	10 100
HT1S302	PH2	25 mm	10 100
HT1S303	PH3	25 mm	10 100



DE Schraubendreherspitzen PH EN PH screwdriver bit FR Embout PH ES Punta de atornillar, PH HR Bitovi odvijača PH HU PH csavarhúzó bitfejek RO Biti surubelnita PH BG Бит накрайки PH

PH 1/4" x10 S2 HRC 58-60 DIN 3126

Folder	Length	Width	Quantity
HT1S304	PH2	25 mm	10 100



DE Schraubendreherspitzen PH EN PH screwdriver bit FR Embout PH ES Punta de atornillar PH HR Bitovi odvijača PH HU PH csavarhúzó bitfejek RO Biti surubelnita PH BG Битове накрайки PH

PH 1/4" x5 SLIM TIN COATED S2 DIN 3126

Folder	Length	Width	Quantity
HT1S382	PH2	25 mm	10 100



DE Schraubendreherspitzen PZ EN PZ screwdriver bit FR Embout PZ ES Punta de atornillar PZ HR Bitovi odvijača PZ HU PZ csavarhúzó bitfejek RO Biti surubelnita PZ BG Бит накрайки PZ

PZ 1/4" x5 ARC anty-slip S2 HRC 58-60 DIN 3126

Folder	Length	Width	Quantity
HT1S307	PZ0	25 mm	10 100
HT1S314	PZ1	25 mm	10 100
HT1S315	PZ2	25 mm	10 100
HT1S316	PZ3	25 mm	10 100



DE Schraubendreherspitzen PZ EN PZ screwdriver bit FR Embout PZ ES Punta de atornillar PZ HR Bitovi odvijača PZ HU PZ csavarhúzó bitfejek RO Biti surubelnita PZ BG Бит накрайки PZ

PZ 1/4" x10 S2 HRC 58-60 DIN 3126

Folder	Length	Width	Quantity
HT1S317	PH2	25 mm	10 100



DE Schraubendreherspitzen PZ EN PZ screwdriver bit FR Embout PZ ES Punta de atornillar PZ HR Bitovi odvijača PZ HU PZ csavarhúzó bitfejek RO Biti surubelnita PZ BG Битове накрайки PZ

PZ 1/4" x5 S2 SLIM TIN COATED DIN 3126

Folder	Length	Width	Quantity
HT1S384	PZ1	25 mm	10 100
HT1S385	PZ2	25 mm	10 100
HT1S386	PZ3	25 mm	10 100



DE Schraubendreherspitzen SL EN SL screwdriver bit FR Embout SL ES Punta de atornillar SL HR Bitovi odvijača SL HU SL csavarhúzó bitfejek RO Biti surubelnita SL BG Бит накрайки SL

SL 1/4" x5 ARC anty-slip S2 HRC 58-60 DIN 3126

Folder	Length	Width	Quantity
HT1S330	SL4	25 mm	10 100
HT1S331	SL5	25 mm	10 100
HT1S332	SL6	25 mm	10 100

DE Schraubendreherstippen tox SLIM EN Torx SLIM screwdriver bit FR Embout tox SLIM ES Punta de atornillar tox SLIM HR Bitovi odvijača tox SLIM HU Tox SLIM csavarhúzó bitfejek RO Biti surubelnita tox SLIM BG Бит накрайки tox SLIM

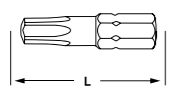





Folder	Symbol	L	mm	mm	mm
HT1S361	T10	25 mm	10	100	
HT1S362	T15	25 mm	10	100	
HT1S363	T20	25 mm	10	100	
HT1S364	T25	25 mm	10	100	
HT1S366	T30	25 mm	10	100	
HT1S367	T40	25 mm	10	100	

TORX 1/4" x2 SLIM

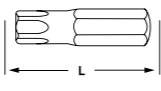
S2 HRC 58-60 DIN 3126

DE Schraubendreherstippen torx EN Torx screwdriver bit FR Embout torx ES Punta de atornillar torx HR Bitovi odvijača torx HU Torx csavarhúzó bitfejek RO Biti surubelnita torx BG Бит накрайки torx







Folder	Symbol	L	mm	mm	mm
HT1S334	T8	25 mm	10	100	
HT1S335	T9	25 mm	10	100	
HT1S336	T10	25 mm	10	100	
HT1S337	T15	25 mm	10	100	
HT1S338	T20	25 mm	10	100	
HT1S339	T25	25 mm	10	100	
HT1S340	T27	25 mm	10	100	
HT1S341	T30	25 mm	10	100	
HT1S342	T40	25 mm	10	100	

TORX 1/4" x5

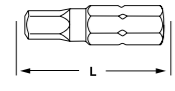
S2 HRC 58-60 DIN 3126

DE Schraubendreherstippen hex SLIM EN Hex SLIM screwdriver bit FR Embout hex SLIM ES Punta de atornillar hex SLIM HR Bitovi odvijača hex SLIM HU Hex SLIM csavarhúzó bitfejek RO Biti surubelnita hex SLIM BG Бит накрайки hex SLIM







Folder	Symbol	L	mm	mm	mm
HT1S343	H3	25 mm	10	100	
HT1S344	H4	25 mm	10	100	
HT1S345	H5	25 mm	10	100	
HT1S346	H6	25 mm	10	100	

HEX 1/4" x2 SLIM

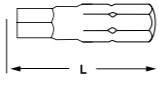
S2 HRC 58-60 DIN 3126

DE Schraubendreherstippen hex EN Hex screwdriver bit FR Embout hex ES Punta de atornillar hex HR Bitovi odvijača hex HU Hex csavarhúzó bitfejek RO Biti surubelnita hex BG Бит накрайки hex







Folder	Symbol	L	mm	mm	mm
HT1S347	H3	25 mm	10	100	
HT1S348	H4	25 mm	10	100	
HT1S349	H5	25 mm	10	100	
HT1S350	H6	25 mm	10	100	

HEX 1/4" x5

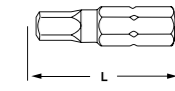
S2 HRC 58-60 DIN 3126

DE Schraubendreherstippen hex SLIM EN Hex SLIM screwdriver bit FR Embout hex SLIM ES Punta de atornillar hex SLIM HR Bitovi odvijača hex SLIM HU Hex SLIM csavarhúzó bitfejek RO Biti surubelnita hex SLIM BG Бит накрайки hex SLIM







Folder	Symbol	L	mm	mm	mm
HT1S359	H3, H4	25 mm	10	100	

HEX 1/4" x2 SLIM

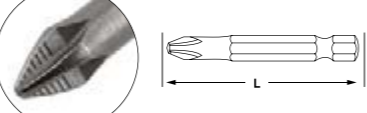
S2 HRC 58-60 DIN 3126

DE Schraubendreherstippen PH EN PH screwdriver bit FR Embout PH ES Punta de atornillar PH HR Bitovi odvijača PH HU PH csavarhúzó bitfejek RO Biti surubelnita PH BG Бит накрайки PH







Folder	Symbol	L	mm	mm	mm
HT1S323	PH0	50 mm	10	100	
HT1S310	PH1	50 mm	10	100	
HT1S311	PH2	50 mm	10	100	
HT1S312	PH3	50 mm	10	100	

PH 1/4" x2 ARC anty-slip

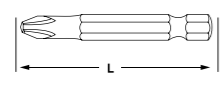
S2 HRC 58-60 DIN 3126

DE Schraubendreherstippen PH EN PH screwdriver bit FR Embout PH ES Punta de atornillar PH HR Bitovi odvijača PH HU PH csavarhúzó bitfejek RO Biti surubelnita PH BG Битове накрайници PH







Folder	Symbol	L	mm	mm	mm
HT1S392	PH2	50 mm	10	100	

PH 1/4" x2 S2

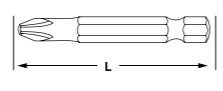
SLIM TIN COATED DIN 3126

DE Schraubendreherstippen PH EN PH screwdriver bit FR Embout PH ES Punta de atornillar PH HR Bitovi odvijača PH HU PH csavarhúzó bitfejek RO Biti surubelnita PH BG Бит накрайки PH







Folder	Symbol	L	mm	mm	mm
HT1S313	PH2	50 mm	10	100	

PH 1/4" x5

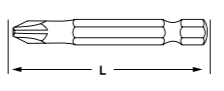
S2 HRC 58-60 DIN 3126

DE Schraubendreherstippen PZ EN PZ screwdriver bit FR Embout PZ ES Punta de atornillar PZ HR Bitovi odvijača PZ HU PZ csavarhúzó bitfejek RO Biti surubelnita PZ BG Бит накрайки PZ







Folder	Symbol	L	mm	mm	mm
HT1S324	PZ0	50 mm	10	100	
HT1S318	PZ1	50 mm	10	100	
HT1S319	PZ2	50 mm	10	100	
HT1S321	PZ3	50 mm	10	100	

PZ 1/4" x2 ARC anty-slip

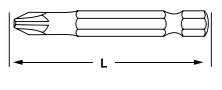
S2 HRC 58-60 DIN 3126

DE Schraubendreherstippen PZ EN PZ screwdriver bit FR Embout PZ ES Punta de atornillar PZ HR Bitovi odvijača PZ HU PZ csavarhúzó bitfejek RO Biti surubelnita PZ BG Бит накрайки PZ







Folder	Symbol	L	mm	mm	mm
HT1S322	PZ2	50 mm	10	100	

PZ 1/4" x5

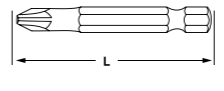
S2 HRC 58-60 DIN 3126

DE Schraubendreherstippen PZ EN PZ screwdriver bit FR Embout PZ ES Punta de atornillar PZ HR Bitovi odvijača PZ HU PZ csavarhúzó bitfejek RO Biti surubelnita PZ BG Битове накрайници PZ







Folder	Symbol	L	mm	mm	mm
HT1S395	PZ2	50 mm	10	100	

PZ 1/4" x2 S2

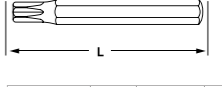
SLIM TIN COATED DIN 3126



DE Schraubendreher-Bit torx EN Torx screwdriver bit FR Embout torx ES Punta de atornillar torx HR Bitovi odvijača torx HU Torx csavarhúzó bitfejek RO Biti surubelnita torx BG Бит крайник torx

Folder	Symbol	L	mm	mm	mm
HT1S846	T20	75 mm	50	250	
HT1S847	T25	75 mm	50	250	
HT1S848	T27	75 mm	50	250	
HT1S849	T30	75 mm	50	250	
HT1S850	T40	75 mm	50	250	
HT1S851	T45	75 mm	50	250	
HT1S852	T50	75 mm	50	250	
HT1S853	T55	75 mm	50	250	

TORX S2 HRC 58-60

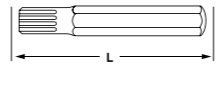

DE Schraubendreher-Bit spline EN SPLINE screwdriver bit FR Embout spline ES Punta de atornillar spline HR Bitovi odvijača spline HU Spline csavarhúzó bit RO Biti surubelnita spline BG Бит крайник SPLINE

Folder	Symbol	L	mm	mm	mm
HT1S885	M5	75 mm	50	250	
HT1S886	M6	75 mm	50	250	
HT1S888	M8	75 mm	50	250	
HT1S890	M10	75 mm	50	250	

SPLINE S2 HRC 58-60

DE Schraubendreher Schlag Bit PH EN PH screwdriver impact bit FR Ensemble de bits de tournevis PH ES Puntas Para Destornilladores PH HR Bitovi set PH HU PH bit készlet RO Set varfurii PH BG Бит крайник ударен PH

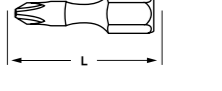





Folder	Symbol	L	mm	mm	mm
HT1S120	PH0	25 mm	10	100	
HT1S121	PH1	25 mm	10	100	
HT1S122	PH2	25 mm	10	100	
HT1S123	PH3	25 mm	10	100	

PH 1/4" x5 S2

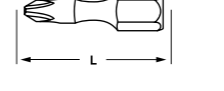
HRC 58-61 DIN 3126

DE Schraubendreher Schlag Bit PZ EN PZ screwdriver impact bit FR Ensemble de bits de tournevis PZ ES Puntas Para Destornilladores PZ HR Bitovi set PZ HU PZ bit készlet RO Set varfurii PZ BG Бит крайник ударен PZ







Folder	Symbol	L	mm	mm	mm
HT1S125	PZ0	25 mm	10	100	
HT1S126	PZ1	25 mm	10	100	
HT1S127	PZ2	25 mm	10	100	
HT1S128	PZ3	25 mm	10	100	

PZ 1/4" x5 S2

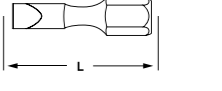
HRC 58-61 DIN 3126

DE Schraubendreher Schlag Bit SL EN SL screwdriver impact bit FR Ensemble de bits de tournevis SL ES Puntas Para Destornilladores SL HR Bitovi set SL HU SL bit készlet RO Set varfurii SL BG Бит крайник ударен SL







Folder	Symbol	L	mm	mm	mm
HT1S130	SL4	25 mm	10	100	
HT1S131	SL5	25 mm	10	100	
HT1S132	SL6	25 mm	10	100	

SL 1/4" x5 S2

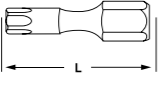
HRC 58-61 DIN 3126



DE Schraubendreher Schlag Bit torx security EN Torx security screwdriver impact bit FR Ensemble de bits de tournevis torx security ES Puntas Para Destornilladores torx security HR Bitovi set torx security HU Torx security Bit készlet RO Set varfuri torx security BG Бит крайник ударен torx security

HT1S135	TT10	25 mm	10	100
HT1S136	TT15	25 mm	10	100
HT1S137	TT20	25 mm	10	100
HT1S138	TT25	25 mm	10	100
HT1S139	TT27	25 mm	10	100
HT1S140	TT30	25 mm	10	100
HT1S141	TT35	25 mm	10	100
HT1S142	TT40	25 mm	10	100

TAMPER TORX 1/4" x5 S2 HRC 58-61 DIN 3126

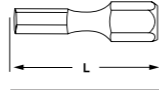

DE Schraubendreher Schlag Bit hex EN Hex screwdriver impact bit FR Ensemble de bits de tournevis hex ES Puntas Para Destornilladores hex HR Bitovi set hex HU Hex bit készlet RO Set varfuri hex BG Бит крайник ударен hex

HT1S145	H3	25 mm	10	100
HT1S146 <td>H4</td> <td>25 mm</td> <td>10</td> <td>100</td>	H4	25 mm	10	100
HT1S147 <td>H5</td> <td>25 mm</td> <td>10</td> <td>100</td>	H5	25 mm	10	100
HT1S148 <td>H6</td> <td>25 mm</td> <td>10</td> <td>100</td>	H6	25 mm	10	100

HEX 1/4" x5 S2 HRC 58-61 DIN 3126

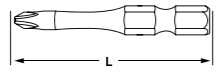

DE Schraubendreher Schlag Bit PH EN PH screwdriver impact bit FR Ensemble de bits de tournevis PH ES Puntas Para Destornilladores PH HR Bitovi set PH HU PH bit készlet RO Set varfuri PH BG Бит крайник ударен PH

HT1S150	PH0	50 mm	10	100
HT1S151	PH1	50 mm	10	100
HT1S152	PH2	50 mm	10	100
HT1S153	PH3	50 mm	10	100

PH 1/4" x2 S2 HRC 58-61 DIN 3126

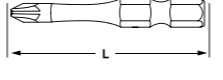

DE Schraubendreher Schlag Bit PZ EN PZ screwdriver impact bit FR Ensemble de bits de tournevis PZ ES Puntas Para Destornilladores PZ HR Bitovi set PZ HU PZ bit készlet RO Set varfuri PZ BG Бит крайник ударен PZ

HT1S155	PZ0	50 mm	10	100
HT1S156	PZ1	50 mm	10	100
HT1S157	PZ2	50 mm	10	100
HT1S158	PZ3	50 mm	10	100

PZ 1/4" x2 S2 HRC 58-61 DIN 3126

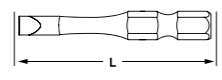

DE Schraubendreher Schlag Bit SL EN SL screwdriver impact bit FR Ensemble de bits de tournevis SL ES Puntas Para Destornilladores SL HR Bitovi set SL HU SL bit készlet RO Set varfuri SL BG Бит крайник ударен SL

HT1S160	SL4	50 mm	10	100
HT1S161	SL5	50 mm	10	100
HT1S162	SL6	50 mm	10	100

SL 1/4" x2 S2 HRC 58-61 DIN 3126

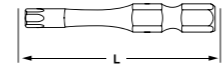

DE Schraubendreher Schlag Bit torx security EN Torx security screwdriver impact bit FR Ensemble de bits de tournevis torx security ES Puntas Para Destornilladores torx security HR Bitovi set torx security HU Torx security Bit készlet RO Set varfuri torx security BG Бит крайник ударен torx security

HT1S165	TT10	50 mm	10	100
HT1S166	TT15	50 mm	10	100
HT1S167	TT20	50 mm	10	100
HT1S168	TT25	50 mm	10	100
HT1S169	TT27	50 mm	10	100
HT1S170	TT30	50 mm	10	100
HT1S171	TT35	50 mm	10	100
HT1S172	TT40	50 mm	10	100

TAMPER TORX 1/4" x2 S2 HRC 58-61 DIN 3126

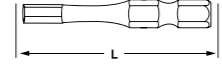

DE Schraubendreher Schlag Bit hex EN Hex screwdriver impact bit FR Ensemble de bits de tournevis hex ES Puntas Para Destornilladores hex HR Bitovi set hex HU Hex bit készlet RO Set varfuri hex BG Бит крайник ударен hex

HT1S175	H3	50 mm	10	100
HT1S176	H4	50 mm	10	100
HT1S177	H5	50 mm	10	100
HT1S178	H6	50 mm	10	100

HEX 1/4" x2 S2 HRC 58-61 DIN 3126

DE Sechskantschlüsselsatz kurz EN Hex key set FR Jeu de clés hexagonales ES Juego de llaves Allen HR Šesterokutni ključevi HU Hex kulcsok RO Chei hex BG Имбусни ключове къси

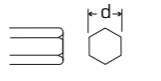





1,5; 2; 2,5; 3; 4; 5; 6; 8; 10

HT1W802	1,5-10 mm	12	72
---------	-----------	----	----

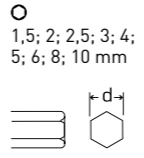
x9 HEX CrV DIN ISO 911 SHORT

DE Sechskantschlüsselsatz lang EN Hex key set, long arm FR Jeu de clés hexagonales ES Juego de llaves Allen HR Šesterokutni ključevi HU Hex kulcsok RO Chei hex BG Имбусни ключове удължени





1,5; 2; 2,5; 3; 4; 5; 6; 8; 10 mm

HT1W801	1,5-10 mm	12	48
---------	-----------	----	----

x9 HEX CrV LONG DIN ISO 911

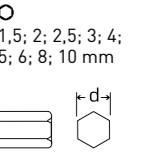
DE Sechskantschlüsselsatz extra lang EN Hex key set, extra long arm FR Jeu de clés hexagonales ES Juego de llaves Allen HR Šesterokutni ključevi HU Hex kulcsok RO Chei hex BG Имбусни ключове много дълги





1,5; 2; 2,5; 3; 4; 5; 6; 8; 10 mm

HT1W803	1,5-10 mm	10	40
---------	-----------	----	----

x9 HEX CrV EXTRA LONG DIN ISO 911

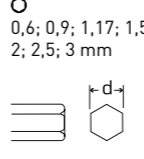
DE Sechskantschlüsselsatz für präzise Arbeiten EN Precision hex key set FR Jeu de clés hexagonales de précision ES Juego de llaves Allen de precisión HR Šesterokutni ključevi, precizni HU Precíziós hex kulcskészlet RO Set de chei hex de precizie BG Имбусни ключове точни





0,6; 0,9; 1,17; 1,5; 2; 2,5; 3 mm

HT1W800	0,71-3,0 mm	12	144
---------	-------------	----	-----

x7 HEX CrV

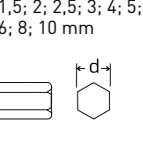
DE Sechskantschlüsselsatz, lange EN Hex key set, long arm FR Jeu de clés hexagonales extra-longues ES Juego de llaves Allen de brazo largo HR Šesterokutni ključevi, dugi, dijagonalni HU Hex kulcsok, hosszú, átlós RO Chei lungi hex, transversal BG Имбусни ключове дълги





1,5; 2; 2,5; 3; 4; 5; 6; 8; 10 mm

HT1W807	1,5-10 mm	6	24
---------	-----------	---	----

x9 HEX CrV EXTRA LONG

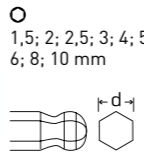
DE Sechskantschlüsselsatz mit Kugelkopf EN Pall-end hex key set, long arm FR Jeu de clés hexagonales à tête sphérique ES Juego de llaves Allen con punta bola, acero HR Šesterokutni ključevi HU Hex kulcsok RO Chei hex BG Имбусни удължени ключове със сферична глава, дълги





1,5; 2; 2,5; 3; 4; 5; 6; 8; 10 mm

HT1W804	1,5-10 mm	12	48
---------	-----------	----	----

x9 HEX CrV LONG

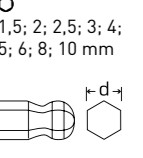
DE Sechskantschlüssel, lange EN Pall-end hex key set, extra long arm FR Jeu de clés hexagonales extra-longues ES Juego de llaves Allen de brazo largo HR Šesterokutni ključevi HU Hex kulcsok RO Chei hex BG Имбусни удължени ключове със сферична глава, много дълги

1,5; 2; 2,5; 3; 4; 5; 6; 8; 10 mm

HT1W808	1,5-10 mm	10	40
---------	-----------	----	----

x9 HEX CrV EXTRA LONG

DE Torx-Schlüsselsatz EN Torx key set, long arm FR Jeu de clés torx ES Juego de llaves torx HR Torx ključevi HU Torx kulcsok RO Chei torx BG Имбусни ключове torx дълги





T10, T15, T20, T25, T27, T30, T40, T45, T50

HT1W814	T10-T50	12	48
---------	---------	----	----

x9 TORX CrV LONG

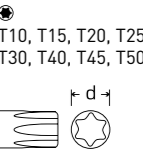
DE Torx-Schlüsselsatz, lang EN Torx key set, extra long arm FR Jeu de clés Torx colorés ES Juego de llaves Torx de brazo largo HR Torx ključevi HU Torx kulcsok RO Chei torx BG Имбусни ключове torx много дълги

T10, T15, T20, T25, T27, T30, T40, T45, T50

HT1W818	T10-T50	10	40
---------	---------	----	----

x9 TORX CrV EXTRA LONG



DE Torx security-Schlüsselsatz EN Torx security key set, long arm FR Jeu de clés torx security ES Juego de llaves torx security HR Torx security ključevi HU Torx security kulcsok RO Chei torx security BG Имбусни ключове torx security, дълги



⊕  
TT10, TT15, TT20, TT25,  
TT27, TT30, TT40, TT45,  
TT50

x9 TAMPER TORX CrV LONG

HT1W809	TT10-TT50	6	48
---------	-----------	---	----

DE Torx security-Schlüsselsatz EN Tamper torx key set, extra long arm FR Jeu de clés torx security ES Juego de llaves torx security HR Torx security ključevi HU Torx security kulcsok RO Chei torx security BG Имбусни ключове torx security, много дълги



⊕  
TT10, TT15, TT20, TT25,  
TT27, TT30, TT40, TT45,  
TT50

x9 TAMPER TORX CrV EXTRA LONG

HT1W810	TT10-TT50	6	340
---------	-----------	---	-----

DE Sechskantschlüsselsatz kurz EN Hex key set FR Jeu de clés hexagonales ES Juego de llaves Allen HR Šesterokutni ključevi HU Hex kulcsok RO Chei hex BG Имбусни ключове къси



○  
1,5; 2; 2,5; 3; 4; 5; 6; 8; 10 mm

x9 HEX S2 SHORT

HT1W820	1,5-10 mm	6	520
---------	-----------	---	-----

DE Sechskantschlüsselsatz lang EN Hex key set, long arm FR Jeu de clés hexagonales ES Juego de llaves Allen HR Šesterokutni ključevi HU Hex kulcsok RO Chei hex BG Имбусни ключове удължени



○  
1,5; 2; 2,5; 3; 4; 5; 6;  
8; 10 mm

x9 HEX S2 LONG

HT1W821	1,5-10 mm	6	500
---------	-----------	---	-----

DE Sechskantschlüsselsatz extra lang EN Hex key set, extra long arm FR Jeu de clés hexagonales ES Juego de llaves Allen HR Šesterokutni ključevi HU Hex kulcsok RO Chei hex BG Имбусни ключове много дълги



○  
1,5; 2; 2,5; 3; 4; 5; 6;  
8; 10 mm

x9 HEX S2 EXTRA LONG

HT1W822	1,5-10 mm	6	340
---------	-----------	---	-----

DE Sechskantschlüssel mit Kugel, lang EN Pall-end hex key set, long arm FR Clés hexagonales à bille, longues ES llaves hexagonales con bola, largas HR Ključevi šesterokutni s kuglicom, dugi HU Hatszögletű golyós kulcs, hosszú RO Chei hexagonale cu bilă, lungi BG Имбусни удължени ключове със сферична глава, дълги



○  
1,5; 2; 2,5; 3; 4; 5; 6;  
8; 10 mm

x9 HEX S2 LONG

HT1W825	1,5-10 mm	5	600
---------	-----------	---	-----

DE Sechskantschlüssel mit Kugel, extra lang EN Pall-end hex key set, extra long arm FR Clés hexagonales à boule, ultra longues ES llaves hexagonales con bola, extra largas HR Ključevi šesterokutni s kuglicom, ekstra dugi HU Hatszögletű kulcsok golyós, extra hosszú RO Chei hexagonale cu bilă, foarte lungi BG Имбусни удължени ключове със сферична глава, много дълги



○  
1,5; 2; 2,5; 3; 4; 5; 6;  
8; 10 mm

x9 HEX S2 EXTRA LONG

HT1W826	1,5-10 mm	6	340
---------	-----------	---	-----

DE Sicherheits-Torx-Schlüssel, lang EN Tamper torx key set FR Clés torx de sécurité, longues ES Llaves torx de seguridad, largas HR Torx sigurnosni ključevi, dugi HU Torx security kulcs, hosszú RO Chei torx security, lungi BG Имбусни ключове torx security, дълги



⊕  
TT10, TT15, TT20,  
TT25, TT27, TT30,  
TT40, TT45, TT50

x9 TAMPER TORX S2 LONG

HT1W830	TT10-TT50	6	500
---------	-----------	---	-----

DE Sicherheits-Torx-Schlüssel, extra lang EN Tamper torx key set, long arm FR Clés torx de sécurité, ultra longues ES Llaves torx de seguridad, extra largas HR Torx sigurnosni ključevi, ekstra dugi HU Torx security kulcs, extra hosszú RO Chei torx security, extra lungi BG Имбусни кључове torx security, много дълги



TT10, TT15, TT20, TT25, TT27, TT30, TT40, TT45, TT50

x9	TAMPER TORX	S2	EXTRA LONG	HT1W831	TT10-TT50	6	340
----	-------------	----	------------	---------	-----------	---	-----

DE Torx-Schlüsselsatz, lang EN Torx key set, long arm FR Jeu de clés Torx ES Juego de llaves torx HR Torx ključevi HU Torx kulcsok RO Chei torx дълги



T10, T15, T20, T25, T27, T30, T40, T45, T50

x9	TORX	S2	LONG	HT1W816	T10-T50	10	40
----	------	----	------	---------	---------	----	----

DE Sechskantschlüsselsatz, lang EN Hex key set FR Jeu de clés hexagonales colorées à tête sphérique ES Juego de llaves Allen de brazo largo HR Šesterokutni ključevi, kodirani bojom HU Hex kulcsok, színkódos RO Chei hex, cu cod de culoare BG Имбусни кључове



1,5; 2; 2,5; 3; 4; 5; 6; 8; 10 mm

x9	HEX	LONG	S2	DIN ISO 911	HT1W806	1,5-10 mm	6	48
----	-----	------	----	-------------	---------	-----------	---	----

DE Torx-Schlüsselsatz, lang, Multicolour EN Torx key set FR Jeu de clés torx colorés ES Juego de llaves Torx de brazo largo HR Torx ključevi, kodirani bojom HU Torx kulcsok, színkódos RO Chei torx, cu cod de culoare BG Имбусни кључове torx



TT10, TT15, TT20, TT25, TT27, TT30, TT40, TT45, TT50

x9	TAMPER TORX	S2	LONG	HT1W817	T10-T50	6	48
----	-------------	----	------	---------	---------	---	----

DE Präzisions-Schraubendreher-Satz EN Precision screwdriver set FR Coffret de tournevis de précision ES Caja destornilladores de precisión HR Set odvijača, precizni HU Precision Screwdriver Set RO Set de surubelnite de precizie BG Комплект прецизни отвертки



Ø 0,5 x 3,0 x 25 mm  
Ø 0,4 x 2,5 x 25 mm  
Ø 0,4 x 2,0 x 25 mm  
Ø 0,3 x 1,6 x 25 mm  
Ø 0 x 3,0 x 25 mm  
Ø 00 x 2,5 x 25 mm

x6	CrV	MAGNETIC	ERGO GRIP	HT1S272	12	72
----	-----	----------	-----------	---------	----	----

DE Präzisions-Schraubendreher-Satz EN Precision screwdriver set FR Coffret de tournevis de précision ES Caja destornilladores de precisión HR Komplet preciznih odvijača HU Precision screwdriver set RO Set de surubelnite de precizie BG Комплект прецизни отвертки



Ø 1,5 x 50 mm  
Ø 2 x 50 mm  
Ø PH00 - 50 mm  
Ø PH0 - 50 mm  
● T5 - 50 mm  
● T6 - 50 mm  
● T7 - 50 mm

x7	MAGNETIC	ERGO GRIP	HT1S270	6	36
----	----------	-----------	---------	---	----

DE Präzisions-Schraubendreher-Satz EN Precision screwdriver set FR Coffret de tournevis de précision ES Caja destornilladores de precisión HR Komplet preciznih odvijača za pametne telefone i prenosna računala HU Precíziós csavarhúzó készlet okostelefonokhoz és laptopokhoz RO Set de surubelnite de precizie, pentru smart-phone-uri si laptopuri BG Комплект прецизни отвертки



Ø 1,2 mm  
Ø 2,0 mm  
● 0,8 / 2,0 mm  
● PH00 / PH000  
● T4 / T5 / T6 / T7 / T8 / T10

x17	CrV	MAGNETIC	ERGO GRIP	HT1S271	6	24
-----	-----	----------	-----------	---------	---	----

DE Schraubendreher EN Screwdriver set FR Jeu de tournevis ES Juego de destornilladores HR Komplet odvijača HU Csavarhúzó készlet RO Set de surubelnite BG Комплект отвертки



Ø 3 x 75 mm  
Ø 5 x 100 mm  
● PH1 - 75 mm  
● PH2 - 100 mm

x4	S2	MAGNETIC	ERGO GRIP	HT1S094	6	24
----	----	----------	-----------	---------	---	----

DE Schraubendreher eingestellt EN Screwdriver set FR Jeu de tournevis ES Juego de destornilladores HR Komplet odvijača HU Csavarhúzó készlet RO Set de surubelnite BG Комплект отвертки



Ø 6 x 100 mm  
Ø 5 x 75 mm  
Ø 3 x 75 mm  
● PH2 x 100 mm  
● PH1 x 75  
● PH0 x 75

x6	S2	MAGNETIC	ERGO GRIP	HT1S095	6	36
----	----	----------	-----------	---------	---	----

DE Schraubendreher eingestellt EN Screwdriver set FR Jeu de tournevis ES Juego de destornilladores HR Komplet odvijača HU Csavarhúzó készlet RO Set de surubelnite BG Комплект отвертки



Ø 6 x 150 mm  
Ø 5 x 75 mm  
Ø 3 x 75 mm  
Ø 6 x 38 mm  
● PH2 x 150 mm  
● PH1 x 75  
● PH0 x 75  
● PH2 x 38

x8	S2	MAGNETIC	ERGO GRIP	HT1S096	6	24
----	----	----------	-----------	---------	---	----

DE Schraubendreher eingestellt EN Screwdriver set FR Jeu de tournevis ES Juego de destornilladores HR Set odvijača HU Csavarhúzó készlet RO Set de surubelnite BG Комплект отвертки



Ø 6 x 125 mm, 5 x 100 mm, 3 x 75 mm, 6 x 38 mm  
● PH2 x 125 mm, PH1 x 100 mm, PH0 x 75 mm, PH2 x 38 mm  
Ø 2,0 x 40 mm, 2,5 x 40 mm  
● PH0 x 40 mm, PH00 x 40 mm

x12	S2	CrV	MAGNETIC	ERGO GRIP	HT1S097	6	12
-----	----	-----	----------	-----------	---------	---	----

DE Schraubendreher EN Screwdriver set FR Jeu de tournevis ES Juego de destornilladores HR Komplet odvijača HU Csavarhúzó készlet RO Set de surubelnite BG Комплект отвертки



Ø 6 x 38 mm, 5 x 75 mm, 6 x 100 mm, 8 x 150 mm  
● PH1 x 75 mm, PH2 x 38 mm, PH2 x 100 mm, PH3 x 150 mm  
Ø 2,5 x 40 mm, 3,0 x 40 mm  
● PH00 x 40 mm, PH0 x 40 mm  
● T5 x 40 mm, T6 x 40 mm, T7 x 40 mm, T8 x 40 mm, T9 x 40 mm, T10 x 40 mm

x18	S2	MAGNETIC	ERGO GRIP	HT1S098	6	24
-----	----	----------	-----------	---------	---	----

DE Schraubendreher eingestellt EN Screwdriver with accessories FR Jeu de tournevis ES Juego de destornilladores HR Set odvijača HU Csavarhúzó készlet RO Set de surubelnite BG Комплект отвертки с аксесоари



Ø SL 3 mm, 4 mm, 5 mm, 6 mm  
● PH0, PH1, PH2, PH2, PH3  
● PZ0, PZ1, PZ2, PZ2, PZ3  
● T10, T15, T20, T25  
● TT10, TT15, TT20, TT25  
● H3, H4, H5, H6  
1/4" socket adapter  
1/4" sockets:  
4 mm, 5 mm, 6 mm, 7 mm, 8 mm, 9 mm

x34	S2	CrV	MAGNETIC	ERGO GRIP	HT1S100	6	24
-----	----	-----	----------	-----------	---------	---	----

DE Schraubendreher eingestellt EN Screwdriver with accessories FR Jeu de tournevis ES Juego de destornilladores HR Set odvijača HU Csavarhúzó készlet RO Set de surubelnite BG Комплект отвертки с аксесоари



Ø SL 3 mm, 4 mm, 5 mm, 6 mm, 7 mm  
● PH0, PH1, PH2, PH3  
● PZ0, PZ1, PZ2, PZ3  
● T10, T15, T20, T25  
● TT10, TT15, TT20, TT25  
● H3, H4, H5, H6  
1/4" socket adapter  
1/4" sockets:  
4 mm, 5 mm, 6 mm, 7 mm, 8 mm, 9 mm, 10 mm, 11 mm, 12 mm

x36	S2	CrV	MAGNETIC	RATCHED HANDLE	ERGO GRIP	HT1S101	6	24
-----	----	-----	----------	----------------	-----------	---------	---	----

DE Schraubendreher Set EN Screwdriver with 1:5 gear and accessories FR Jeu de tournevis ES Juego de destornilladores HR Odvijač s nastavcima HU Csavarhúzó készlet RO Set de surubelnite BG Отвертка с бит държач тресчотна 1:5 с аксесоари



Ø 3 mm, 4 mm, 5 mm, 6 mm  
● PH0, PH1, PH2, PH3  
● T10, T15, T20, T25

x13	360° 1:5	S2	MAGNETIC	ERGO GRIP	HT1S215	6	36
-----	----------	----	----------	-----------	---------	---	----

DE Schraubendreher Set EN Screwdriver with 1:5 gear and accessories FR Jeu de tournevis ES Juego de destornilladores HR Odvijač s nastavcima HU Csavarhúzó készlet RO Set de surubelnite BG Отвертка с бит държач тресчотна 1:5 и чупеца дръжка с аксесоари



Ø 3 mm, 4 mm, 5 mm, 6 mm  
● PH0, PH1, PH2, PH3  
● T10, T15, T20, T25

x13	360° 1:5	S2	MAGNETIC	RATCHED HANDLE	ERGO GRIP	HT1S216	6	36
-----	----------	----	----------	----------------	-----------	---------	---	----



DE Schraubendreher eingestellt EN Screwdrivers set FR Jeu de Tournevis ES Juego de destornilladores HR Set odvijača HU Csavarhúzó készlet RO Set de surubelnite BG Комплект отвертки



- ⊖ 6 x 125 mm, 5 x 100 mm, 3 x 75 mm
- ⊕ PH2 x 125 mm, PH2 x 100 mm, PH1 x 100 mm, PH0 x 75 mm
- Precision screwdrivers:
- ⊖ 2.0 x 50 mm, 2.5 x 50 mm
- T6 x 50 mm, T8 x 50 mm
- ⊕ PH00 x 50 mm, PH000 x 50 mm
- 1/4" socket adapter
- Magnetizer
- Magnetic handle
- 1/4" bit handle
- Off-set key:
- PH2 x SL 6 mm, PH1 x SL 5 mm
- 1/4" screwdriver bits:
- ⊖ SL 3 mm, 2 x 4 mm, 2 x 5 mm, 2 x 6 mm
- ⊕ PH0, 2 x PH1, 2 x PH2, 2 x PH3
- PZ0, 2 x PZ1, 2 x PZ2, PZ3
- T10, T15, T20, T25, T27, T30, T35
- H3, H4, H5, H6
- S0, S1, S2, S3
- 1/4" sockets:
- 4 mm, 5 mm, 6 mm, 7 mm, 8 mm, 9 mm, 10 mm, 11 mm, 12 mm

x64 S2 CrV MAGNETIC ERGO GRIP

HT1S105	6	12

DE Schraubendreher eingestellt EN Screwdrivers set FR Jeu de Tournevis ES Juego de destornilladores HR Set odvijača i bitova HU Csavarhúzó és bitfej készlet RO Set de surubelnite si biti BG Комплект отвертки



- 16 screwdrivers
- ⊖ Flat screwdrivers: 3 x 75 mm, 5 x 75 mm, 5 x 100 mm, 6 x 100 mm, 6 x 150 mm, 8 x 150 mm
- ⊕ Cross screwdrivers: PH0 x 75 mm, PH1 x 75 mm, PH1 x 100 mm, PH2 x 100 mm, PH2 x 150 mm
- Torx screwdrivers: T10 x 75 mm, T15 x 75 mm, T20 x 75 mm
- ⊙ Square screwdrivers: S1 x 75 mm, S2 x 100 mm
- Screwdriver bits on socket 1" (48 pieces)
- 3 mm, 3 mm, 4 mm, 4 mm, 5 mm, 5 mm, 6 mm, 6 mm
- ⊕ PH0, PH0, PH1, PH1, PH2, PH2, PH3, PH3
- T10, T10, T15, T15, T20, T20, T20, T25, T25, T27, T27, T30, T30
- H3, H3, H4, H4, H5, H5, H5, H6, H6, H6
- S0, S0, S1, S1, S2, S2, S3, S3
- Hexagonal screwdrivers (16 pieces)
- 1.5 mm, 2.0 mm, 2.5 mm, 3.0 mm, 4.0 mm, 5.0 mm, 5.5 mm, 6.0 mm
- 1/16", 5/64", 3/32", 1/8", 5/32", 3/16", 7/32", 1/4"
- Precision screwdriver bits (20 pieces)
- PH000, PH000, Y000, Y000
- 0.8 mm, 0.8 mm, 1.2 mm, and 1.2 mm
- T4, T4, T5, T5, T6, T6
- 1.0 mm, 1.0 mm, 1.5 mm, 1.5 mm, 2.0 mm, 2.0 mm
- Nut Drivers (6 pieces)
- 6 mm, 7 mm, 8 mm, 9 mm, 10 mm, 11 mm
- Precision screwdrivers (6 pieces)
- 2.0 x 40 mm, 2.5 x 40 mm, 3.0x40 mm,
- PH00 x 40 mm, PH0 x 40 mm, T10 x 40 mm
- Bit adapter
- Precision bit adapter
- Socket adapter



x114 S2 CrV MAGNETIC ERGO GRIP

HT1S099	3	6

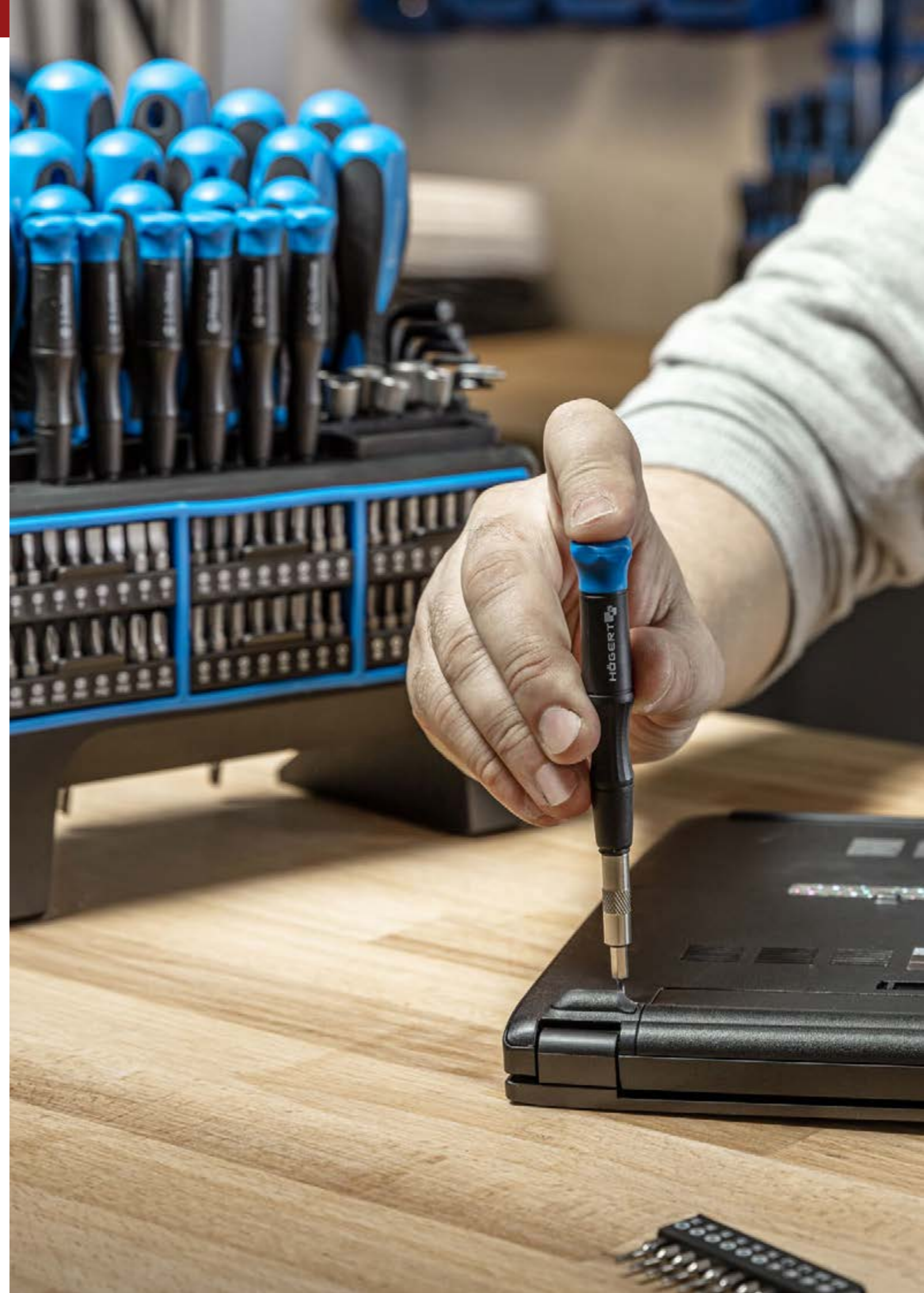

**DE** Bit-Schraubendreher, kurze Ausführung mit Ratsche **EN** Ratcheting multi-bit screwdriver **FR** Tournevis multi-embouts à cliquet **ES** Destornillador multipuntas de carraca **HR** Odvijač sa zamenljivim bitovima **HU** Multi-bitfej csavarhúzó **RO** Surubelnita multi-bit **BG** Отвертка с тресчотка и битове



3 mm, 6 mm  
 ⊕ PH1  
 ⊕ PH2  
 ⊕ PH3  
 ⊙ T15  
 ⊙ T20  
 ⊙ H4

x9	length 10cm	S2	MAGNETIC	ERGO GRIP
----	----------------	----	----------	-----------

HT1S214	10	100
---------	----	-----

**DE** Steckschlüssel-Schraubendreher **EN** Screwdriver bit holder **FR** Tournevis porte-embout **ES** Destornillador Portapuntas **HR** Ručka za bitove odvijajača **HU** Csavarhúzó bitfej adapter **RO** Maner biti tip surubelnita **BG** Отвертка с бит държач



100mm

1/4"	CrV	ERGO GRIP
------	-----	-----------

HT1S201	1/4"	100 mm	12	144
---------	------	--------	----	-----

**DE** Schlagschrauber **EN** Impact screwdriver **FR** Tournevis à percussion **ES** Destornillador de impacto **HR** Udarni odvijač **HU** Ütésescsavarhúzó **RO** Șurubelniță de impact **BG** Ударна отвертка



1/2" - 12.7 mm  
 5/16" - 7.9 mm  
 ⊖ 6 x 36 mm  
 ⊖ 8 x 36 mm  
 ⊖ 8 x 78 mm  
 ⊕ PH2 x 36 mm  
 ⊕ PH3 x 36 mm  
 ⊕ PH3 x 78 mm

CrV	1/2" 12.7 mm	5/16" 7.9 mm
-----	-----------------	-----------------

HT1S077	1	20
---------	---	----

**DE** Präzisions-Schraubendreher-Satz **EN** Insulated 1000 V precision screwdriver set **FR** Jeu de tournevis de précision isolé 1000 V **ES** Pack de destornilladores de precisión 1000 V **HR** Komplet preciznih odvijača 1000 V **HU** Precíziós szigetelt csavarhúzó készlet 1000 V **RO** Set de surubelnite izolate de precizie 1000 V **BG** Комплект отверки прецизни VDE 1000 V



⊖ 1,5 x 50 mm  
 ⊖ 2,0 x 50 mm  
 ⊖ 3,0 x 50 mm  
 ⊕ PH00 - 50 mm  
 ⊕ PH0 - 50 mm  
 ⊕ PH1 - 50 mm

x6	VDE 1000V	CrMo	MAGNETIC	ERGO GRIP
----	-----------	------	----------	-----------

HT1S986	12	72
---------	----	----

**DE** Schlitz-Schraubendreher **EN** Slotted screwdriver **FR** Tournevis plat **ES** Destornillador de punta plana **HR** Ravni odvijajači **HU** Lapos csavarhúzó **RO** Surubelnite dreapte **BG** Отвертка права SL



HT1S001	3	75 mm	163 mm	12	360
HT1S002	3	100 mm	188 mm	12	360
HT1S004	4	100 mm	188 mm	12	360
HT1S008	5	100 mm	198 mm	12	240
HT1S010	6,5	38 mm	104 mm	12	360
HT1S012	6	100 mm	208 mm	12	144
HT1S014	6	150 mm	258 mm	12	144
HT1S015	6,5	200 mm	308 mm	12	144

SL	S2	MAGNETIC	ERGO GRIP
----	----	----------	-----------

**DE** Kreuzschlitzschraubendreher **PH** **EN** PH screwdriver **FR** Tournevis **ES** Destornillador PH **HR** Križni odvijajači **PH** **HU** PH csavarhúzó **RO** Surubelnite PH **BG** Отвертка PH



HT1S020	PH0	75 mm	163 mm	12	360
HT1S023	PH1	75 mm	173 mm	12	240
HT1S024	PH1	100 mm	198 mm	12	240
HT1S028	PH2	38 mm	104 mm	12	360
HT1S029	PH2	100 mm	208 mm	12	144
HT1S032	PH2	200 mm	308 mm	12	144

PH	S2	MAGNETIC	ERGO GRIP
----	----	----------	-----------

**DE** Schraubendreher-Satz 1000 V **EN** Insulated 1000 V screwdriver set **FR** Pack de tournevis isolés 1000 V **ES** Pack de destornilladores aislados 1000 V **HR** Komplet odvijajača 1000 V **HU** Lapos csavarhúzó készlet 1000 V **RO** Set de surubelnite izolate dreapte **BG** Комплект отверки 1000 V



⊖ 5,5  
 ⊕ PH2

x2	VDE 1000V	SL	PH
----	-----------	----	----

S2	MAGNETIC	ERGO GRIP
----	----------	-----------

HT1S990	L1	L2	6	72
	125 mm	223 mm	12	72
	100 mm	210 mm		

**DE** Schraubendreher-Satz 1000 V **EN** Insulated 1000 V screwdriver set **FR** Pack de tournevis isolés 1000 V **ES** Pack de destornilladores aislados 1000 V **HR** Komplet odvijajača 1000 V **HU** Lapos csavarhúzó készlet 1000 V **RO** Set de surubelnite izolate dreapte **BG** Комплект отверки 1000 V



x5	VDE 1000V	100-250V	S2
----	-----------	----------	----

MAGNETIC	ERGO GRIP	EN 60900
----------	-----------	----------

HT1S994	⊖	L1	L2	6	24
	⊖ 3,5	100 mm	188 mm		
	⊖ 5,5	125 mm	223 mm		
	⊕ PH1	80 mm	178 mm		
	⊕ PH2	100 mm	210 mm		
	Voltage tester				

**DE** Kreuzschlitzschraubendreher **PZ** **EN** PZ screwdriver **FR** Tournevis Pozidriv **ES** Destornillador Pozidriv **PZ** **HR** Križni odvijajači **PZ** **HU** PZ csavarhúzó **RO** Surubelnite PZ **BG** Отвертка PZ



HT1S040	PZ0	75 mm	163	12	360
HT1S041	PZ1	100 mm	173	12	240
HT1S042	PZ2	100 mm	208	12	144

PZ	S2	MAGNETIC	ERGO GRIP
----	----	----------	-----------

**DE** Schraubendreher torx **EN** Torx Screwdriver **FR** Tournevis torx **ES** Destornillador torx **HR** Odvijajači torx **HU** Torx csavarhúzó **RO** Surubelnite torx **BG** Отвертка torx



HT1S051	T8	75 mm	163 mm	12	240
HT1S053	T10	100 mm	198 mm	12	240
HT1S054	T15	100 mm	198 mm	12	240
HT1S055	T20	100 mm	198 mm	12	240
HT1S056	T25	100 mm	208 mm	12	144
HT1S057	T27	100 mm	208 mm	12	144
HT1S058	T30	100 mm	208 mm	12	144
HT1S059	T40	150 mm	268 mm	6	96

TORX	S2	MAGNETIC	ERGO GRIP
------	----	----------	-----------

**DE** Schraubendreher-Satz 1000 V **EN** Insulated 1000 V screwdriver set **FR** Pack de tournevis isolés 1000 V **ES** Pack de destornilladores aislados 1000 V **HR** Komplet odvijajača 1000 V **HU** Lapos csavarhúzó készlet 1000 V **RO** Set de surubelnite izolate dreapte **BG** Комплект отверки 1000 V



x6	VDE 1000V	S2
----	-----------	----

MAGNETIC	ERGO GRIP	EN 60900
----------	-----------	----------

HT1S996	⊖	L1	L2	6	24
	⊖ 2,5	75 mm	163 mm		
	⊖ 4	100 mm	188 mm		
	⊖ 5,5	125 mm	223 mm		
	⊕ PH0	60 mm	148 mm		
	⊕ PH1	80 mm	178 mm		
	⊕ PH2	100 mm	208 mm		

**DE** Schraubendreher-Satz 1000 V **EN** Insulated 1000 V screwdriver set **FR** Pack de tournevis isolés 1000 V **ES** Pack de destornilladores aislados 1000 V **HR** Set odvijajača, izolirani 1000 V **HU** Csavarhúzó készlet 1000 V **RO** Set de surubelnite 1000 V **BG** Комплект отверки 1000 V



⊖ 1,2 x 6,5 x 100 mm,  
 1,0 x 5,5 x 100 mm,  
 0,8 x 4,0 x 100 mm,  
 0,5 x 3,0 x 100 mm  
 ⊕ PH2 x 100 mm,  
 PH1 x 80 mm,  
 PZ2 x 100 mm,  
 PZ1 x 80 mm  
 ⊙ T10 x 100 mm,  
 T15 x 100 mm,  
 T20 x 100 mm  
 Voltage tester 140 mm

x13	VDE 1000V	S2	MAGNETIC	ERGO GRIP
-----	-----------	----	----------	-----------

HT1S997	1	72
---------	---	----

**DE** Schraubendreher mit Schlagkappe **EN** Demolition SL screwdriver **FR** Tournevis plat à frapper **ES** Destornillador de impacto **HR** Ravni odvijajači za udaranje **HU** Lapos bontó csavarhúzó **RO** Surubelnite dreapte pentru demolare **BG** Отвертка SL задвижване



HT1S064	5,5	100 mm	200 mm	12	144
HT1S066	6	125 mm	233 mm	12	144
HT1S068	8	150 mm	266 mm	6	96

IMPACT CORE	EXTRA TORQUE	CrV	MAGNETIC	ERGO GRIP
-------------	--------------	-----	----------	-----------

**DE** Schraubendreher mit Schlagkappe **EN** Demolition PH screwdriver **FR** Tournevis à frapper **ES** Destornillador de impacto **HR** Križni odvijajači za udaranje **HU** Bontó csavarhúzó **RO** Surubelnite pentru demolare **BG** Отвертка PH задвижване



HT1S072	PH2	125 mm	233 mm	12	144
---------	-----	--------	--------	----	-----

IMPACT CORE	EXTRA TORQUE	CrV	MAGNETIC	ERGO GRIP
-------------	--------------	-----	----------	-----------

**DE** Schraubendreher-Satz 1000 V **EN** Insulated 1000 V screwdriver set **FR** Pack de tournevis isolés 1000 V **ES** Pack de destornilladores aislados 1000 V **HR** Set odvijajača, izolirani 1000 V **HU** Csavarhúzó készlet 1000 V **RO** Set de surubelnite 1000 V **BG** Комплект отверки 1000 V



⊖ 5,5 x 100 mm,  
 4,0 x 100 mm  
 ⊕ PZ2 x 100 mm  
 ⊕ PH2 x 100 mm,  
 PH1 x 80 mm  
 Keys for switch cabinets:  
 triangle  
 square

x8	VDE 1000V	S2	MAGNETIC	ERGO GRIP
----	-----------	----	----------	-----------

HT1S998	6	12
---------	---	----

**DE** Schlitz-Schraubendreher 1000 V **SL** **EN** Insulated 1000 V SL screwdriver **FR** Tournevis plat isolé 1000 V **SL** **ES** Destornillador aislado de punta plana 1000 V **SL** **HR** Ravni odvijajači 1000 V **HU** Szigetelt lapos csavarhúzó **RO** Surubelnite izolate dreapte **BG** Отвертка 1000 V SL

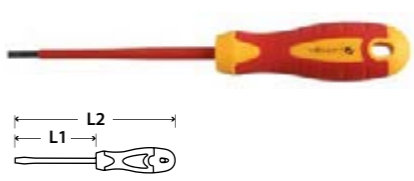

VDE 1000V	SL	S2
-----------	----	----

MAGNETIC	ERGO GRIP	EN 60900
----------	-----------	----------

HT1S902	2,5	75 mm	163 mm	12	360
HT1S903	3	100 mm	188 mm	12	360
HT1S904	4	100 mm	188 mm	12	360
HT1S905	5,5	100 mm	223 mm	12	240

DE Schlitz-Schraubendreher 1000 V SL SLIM EN Insulated 1000 V SLIM screwdriver  
FR Tournavis à fente isolé 1000 V SLSLIM ES Destornillador plano 1000 V SL SLIM  
HR Ravní odvijači 1000 V SL SLIM HU Szigetelt lapos csavarhűzők RO Surubelnite izolate drepte BG Отверка 1000 V SL SLIM

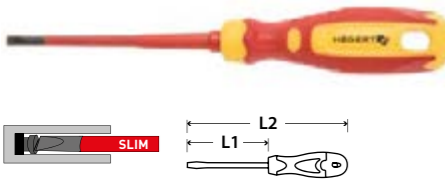

SLIM

VDE 1000V SL SLIM CrMo

HT1S960	3	100 mm	174 mm	24	480
HT1S961	4	100 mm	192 mm	12	240
HT1S962	5,5	125 mm	217 mm	12	240

MAGNETIC ERGO GRIP EN 60900

DE Kreuzschlitzschraubendreher 1000 V PH EN Insulated 1000 V PH screwdriver  
FR Tournavis isolé 1000 V PH ES Destornillador aislado de punta plana 1000 V PH  
HR Križni odvijači 1000 V PH HU Szigetelt PH csavarhűzők RO Surubelnita izolata PH  
BG Отверка 1000 V PH



PH

VDE 1000V PH S2

HT1S920	PH0	60 mm	148 mm	12	360
HT1S922	PH1	80 mm	178 mm	12	240
HT1S924	PH2	100 mm	208 mm	12	144

MAGNETIC ERGO GRIP EN 60900

DE Kreuzschlitzschraubendreher 1000 V PH SLIM EN Insulated 1000 V PH screwdriver  
FR Tournavis isolé 1000 V PH SLIM ES Destornillador philips 1000 V PH SLIM  
HR Križni odvijači 1000 V, SLIM HU Szigetelt PH csavarhűző RO Surubelnite izolate 1000 V PH SLIM BG Отверка 1000 V PH SLIM

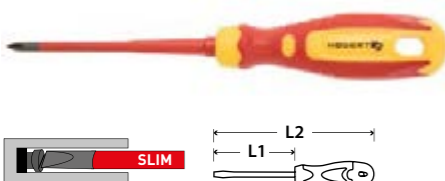

SLIM

VDE 1000V PH SLIM CrMo

HT1S965	PH1	100 mm	192 mm	12	240
HT1S966	PH2	100 mm <td>210 mm <td>12</td> <td>120</td> </td>	210 mm <td>12</td> <td>120</td>	12	120

MAGNETIC ERGO GRIP EN 60900

DE Kreuzschlitzschraubendreher 1000 V PZ EN Insulated 1000 V PZ screwdriver  
FR Tournavis Pozidriv isolé 1000 V PZ ES Destornillador aislado de punta plana Pozidriv  
PZ HR Križni odvijači 1000 V PZ HU Szigetelt PZ Pozidriv csavarhűző RO Surubelnita izolata PZ Pozidriv  
BG Отверка 1000 V PH PZ



PZ

VDE 1000V PZ S2

HT1S940	PZ0	60 mm	148 mm	12	360
HT1S941	PZ1	80 mm	178 mm	12	240
HT1S944	PZ2	100 mm	208 mm	12	144

MAGNETIC ERGO GRIP EN 60900

DE Kreuzschlitzschraubendreher 1000 V PZ SLIM EN Insulated PZ SLIM screwdriver  
FR Tournavis isolé 1000 V PZ SLIM ES Destornillador philips 1000 V PZ SLIM  
HR Križni odvijači 1000 V PZ SLIM HU Szigetelt PH csavarhűző RO Surubelnite izolate PH  
BG Отверка 1000 V PZ SLIM

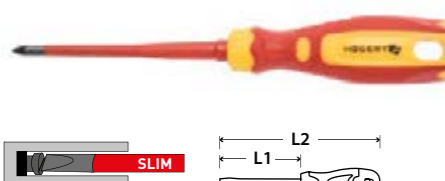

SLIM

VDE 1000V PZ SLIM CrMo

HT1S968	PZ1	100 mm	210 mm	12	240
HT1S969	PZ2	100 mm <th>210 mm</th> <th>12</th> <th>240</th>	210 mm	12	240

MAGNETIC ERGO GRIP EN 60900

DE Schraubendreher für Plus-Minus Klemmschrauben EN Insulated 1000 V SLIM screwdriver  
FR Tournavis à sertir 1000 V ES Destornillador para cuadros de la luz 1000 V, SLIM  
HR Odvijači 1000 V SLIM HU Szigetelt PH csavarhűzők RO Surubelnite izolate PH  
BG Отверка крест-плоска 1000 V SLIM



SLIM PH

VDE 1000V SLIM PH

HT1S973	PH1/SL5	100 mm	192 mm	12	240
HT1S974	PH2/SL6	100 mm	210 mm	12	120
HT1S976	PZ1/SL5	100 mm	192 mm	12	240
HT1S977	PZ2/SL6	100 mm	210 mm	12	120

MAGNETIC ERGO GRIP EN 60900

DE Ringschlüsselset, offen EN Double open-end spanner set FR Jeu de clés à double extrémités ES Juego de llaves fija HR Komplet poluotvorenih okastih ključeva  
HU Kétoldalú villáskulcs készlet RO Set de chei fixe duble BG Комплект гаечни ключове отворени



25 YEAR WARRANTY

8 x 10, 11 x 12, 13 x 14, 15 x 17 mm

x4 CrV DIN 838

HT1W730	8-17 mm	1	20
---------	---------	---	----

DE Torx Ringschlüssel-Set EN Torx ring spanner set FR Jeu de Clés à oeil torx ES Llaves planas cabezal torx HR Komplet okastih ključeva torx HU Kétoldalú torx kulcs RO Maner T glisant cu cheie torx BG Ключове звездогачени torx комплект



E6 x E8, E10 x E12, E14 x E18, E20 x E24

x4 TORX CrV

HT1W590	E6-E24	4	40
---------	--------	---	----

DE Ringschlüssel Typ "C" EN C-Type Ring Spanner Set FR Jeu de clés plates courbés en forme «C» ES Juego de llaves de estrella en C HR Set okastih "C" ključeva  
HU C-típusú csillagkulcs készlet RO Set de chei inelare duble tip C BG Комплект звездогачени ключове, извити, C - форма



25 YEAR WARRANTY

8 x 10, 11 x 13, 14 x 15, 16 x 17, 19 x 22 mm

x5 8-22 mm CrV

HT1W599	8-22 mm	6	24
---------	---------	---	----

DE Maul-Ring-Schlüsselset EN Combination spanners set FR Kit de Clés Mixtes à cliquet en acier ES Juego de llaves combinadas HR Komplet okasto-viličastih ključeva  
HU Kombinált villáskulcs készlet RO Set de chei combinate BG Комплект ключове гаечни плоски

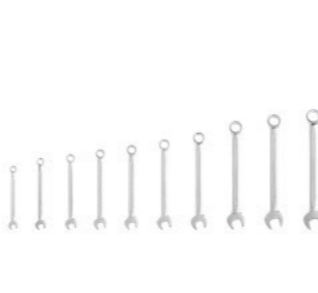

25 YEAR WARRANTY

6, 8, 10, 11, 12, 13, 14, 15, 17, 19, 22, 24 mm

x12 CrV 15° AS SYSTEM DIN 3113

HT1W492	6-24 mm	1	10
---------	---------	---	----

DE Schrauben-Ring-Schlüssel EN Combination spanner FR Clés Mixtes en acier ES Llave combinada HR Okasto-viljuškasti ključevi HU Kombinált villáskulcsok RO Chei combinate  
BG Ключ звездогачен



25 YEAR WARRANTY

HT1W406	6 mm	110	15	10,8	4	4,9	5	300
HT1W407	7 mm	116	17,2	11,8	4,2	5,2	5	300
HT1W408	8 mm	128	19,4	13,5	4,5	5,5	5	300
HT1W409	9 mm	137	21	14,6	4,8	6	5	250
HT1W410	10 mm	148	23,5	16,3	5,2	6,5	5	250
HT1W411	11 mm	157	25,2	17,3	5,5	7	5	250
HT1W412	12 mm	169	27,5	19	5,8	7,5	5	250
HT1W413	13 mm	176	29,4	20	6,1	7,9	5	250
HT1W414	14 mm	186	31,5	22	6,5	8,4	5	150
HT1W415	15 mm	196	33,1	23	6,8	8,8	5	150
HT1W416	16 mm	207	34,8	24,4	7	9,3	5	100
HT1W417	17 mm	219	37	25,6	7,2	9,8	5	100
HT1W418	18 mm	228	38,3	27	7,5	10,3	5	100
HT1W419	19 mm	238	40,8	28,6	7,8	10,8	5	100
HT1W420	20 mm	249	42,6	30	8,1	11,2	5	100
HT1W421	21 mm	260	44,8	31,7	8,4	11,6	5	60
HT1W422	22 mm	270	47,2	33,2	8,7	12,1	5	60
HT1W424	34 mm	289	50,3	35,6	9,3	13	5	60
HT1W425	25 mm	300	52,4	37,2	9,5	13,3	5	60
HT1W426	26 mm	309	54,4	38,6	9,8	13,6	5	60
HT1W427	27 mm	320	56,4	40	10,9	13,9	5	60
HT1W428	28 mm	338	60	42,4	10,5	14,8	5	60
HT1W430	30 mm	352	62,4	44,2	11	15,3	5	60
HT1W432	32 mm	370	66,4	47	11,6	15,7	5	30
HT1W436	36 mm	452	73	51,6	13,2	17,5	5	20
HT1W441	41 mm	480	84	62	15	19	5	20
HT1W446	46 mm	495	94	68	15,5	20	5	20
HT1W450	50 mm	505	103	74	16,5	21	5	20
HT1W455	55 mm	670	109	81	20	29	1	5

CrV 15° AS SYSTEM DIN 3113

DE Doppelringschlüsselset EN Bi-hexagonal ring spanner set FR Kit de clés à fourche en acier ES Juego de llaves de estrella, acero HR Komplet okastih ključeva HU Hajlított csillagkulcs készlet RO Set de chei inelare duble cotite BG Комплект звездогачени ключове, извити



25 YEAR WARRANTY

6 x 7, 8 x 9, 10 x 11, 12 x 13, 14 x 15, 16 x 17, 18 x 19, 20 x 22 mm

x8 CrV DIN 838

HT1W598	6-22 mm	1	10
---------	---------	---	----

DE Maul-Ring-Schlüsselset EN Combination spanners set FR Kit de Clés Mixtes à cliquet en acier ES Juego de llaves combinadas HR Komplet okasto-viličastih ključeva  
HU Kombinált villáskulcs készlet RO Set de chei combinate BG Комплект ключове гаечни плоски



25 YEAR WARRANTY

6, 7, 8, 9, 10, 11, 12, 13, 14, 15, 16, 17, 18, 19, 20, 21, 22, 23, 24, 25, 26, 27, 28, 29, 30, 32 mm

x26 CrV 15° ASS DIN 3113

HT1W496	6-32 mm	1	4
---------	---------	---	---

DE Schrauben-Ring-Schlüssel mit Ratsche EN Combination ratchet spanner FR Clés Mixtes, en acier ES Llave combinada con trinquete HR Viljuškasto-okasti ključevi  
HU Kombinált racsnó villáskulcsok RO Chei combinate cu clichet BG Ключ звездогачен с тресчотка



25 YEAR WARRANTY

HT1R006	6 mm	121	15	14,3	4,5	6,3	5	200
HT1R007	7 mm	130	16,4	16,8	4,8	6,5	5	200
HT1R008	8 mm	140	18	18,3	5,3	7,2	5	200
HT1R009	9 mm	150	20	20	5,7	7,5	5	200
HT1R010	10 mm	160	22	21,5	6	7,8	5	200
HT1R011	11 mm	165	24,5	23,5	6,2	8,4	5	200
HT1R012	12 mm	170	26	25	6,5	8,8	5	200
HT1R013	13 mm	180	28	26,4	6,8	9,1	5	200
HT1R014	14 mm	190	30,8	28	7,2	9,4	5	200
HT1R015	15 mm	200	33	30	7,5	9,8	5	100
HT1R016	16 mm	210	34,5	31,5	7,8	10,2	5	100
HT1R017	17 mm	225	37	33	8,1	10,5	5	100
HT1R018	18 mm	235	39,5	35	8,5	10,8	5	100
HT1R019	19 mm	245	40,8	36,5	8,8	11,2	5	100
HT1R020	20 mm	245	40,8	36,5	8,8	11,2	5	100
HT1R021	21 mm	290	44,8	42,5	9,5	13,5	5	50
HT1R022	22 mm	290	44,8	42,5	9,5	13,5	5	50
HT1R024	24 mm	332	52,8	48,5	10,5	14,5	5	50
HT1R027	27 mm	359	56	53	11,2	15,7	5	40
HT1R030	39 mm	404	62	58	11,7	17	5	20
HT1R032	32 mm	424	65	62	12,3	17,5	5	20

CrV 15° AS SYSTEM DIN 3113

DE Schrauben-Ring-Schlüssel mit Gelenk und Ratsche EN Combination ratchet spanner with flex head FR Clés Mixtes, tête inclinable ES Llave combinada con trinquete articulada HR Ključevi viljuškasto-okasti sa zglobom i čegrtaljkom HU Kombinált racsnis villáskulcsok csuklóval RO Chei combinate cu clichet si capat rotativ BG Ключ звездагачен с тресчотка с подвижна глава

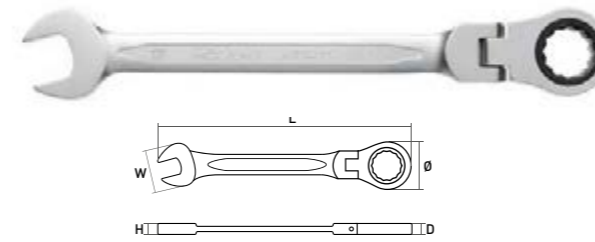

CrV 15° AS SYSTEM DIN 3113



	L	W	Φ	H	D			
HT1R048	8 mm	138	18	18,3	5,3	7,2	5	200
HT1R050	10 mm	158	22	21,5	6	7,8	5	200
HT1R051	11 mm	163	24,5	23,5	6,2	8,4	5	200
HT1R052	12 mm	168	26	25	6,5	8,8	5	200
HT1R053	13 mm	178	28	26,4	6,8	9,1	5	200
HT1R054	14 mm	188	30,8	28	7,2	9,4	5	100
HT1R055	15 mm	196	33	30	7,5	9,8	5	100
HT1R056	16 mm	208	34,5	31,5	7,8	10,2	5	100
HT1R057	17 mm	223	37	33	8,1	10,5	5	100
HT1R058	18 mm	233	39,5	35	8,5	10,8	5	100
HT1R059	19 mm	243	40,8	36,5	8,8	11,2	5	100
HT1R061	21 mm	288	44,8	42,5	9,5	13,5	5	50

DE Tubing Ratschenschlüssel EN Open end flare nut ratchet wrench FR Clé à Cliquet pour Tubes ES Llave de Tubo de Trinquete HR Viličasto-okasti ključ poluotvoreni s čegrtaljkom HU Racsnis kulcs nyitott RO Cheie inelara cu clichet pentru conducte BG Ключ звездагачен отворен с тресчотка



72T CrV

	L	W	Φ	H	D			
HT1R070	8 mm	160	23	28,2	6	13,3	1	10
HT1R071	10 mm	160	23	28,2	6	13,3	1	10
HT1R072	13 mm	190	30	34,7	6,5	14,5	1	10
HT1R073	17 mm	215	36	39,3	7	15,3	1	10
HT1R074	19 mm	230	40	43,5	8,3	16,5	1	10

DE Maul-Ringratschenschlüssel Set EN Combination ratchet spanners set FR Kit de Clés Mixtes, en acier ES Juego llaves combinadas con trinquete HR Combination ratchet spanner set HU Racsnis kombinált villáskulcs készlet RO Set de chei combinate cu clichet BG Комплект ключове звездагачени с тресчотка



x7 CrV 15° AS SYSTEM DIN 3113

	L	W	Φ	H	D			
HT1R397	10-19 mm						5	20

DE Seitenschneider EN Diagonal side cutters FR Pince coupante ES Alicates de corte diagonal HR Bočna kliješta HU Oldalcsípő fogók RO Cleste cu taitura laterala BG Клеци резачки



CrV HRC 58-62 DIN 5749 180° ERGO GRIP

	L	W	Φ	H	D			
HT1P010	160 mm						6	60
HT1P012	180 mm						6	60

DE Maul-Ring-Schlüsselset EN Combination spanners set FR Kit de Clés Mixtes en acier ES Juego de llaves combinadas HR Komplet okasto-viljuškastih ključeva HU Kombinált villáskulcs készlet RO Set de chei combinate BG Комплект ключове гаечни плоски



x7 CrV 15° AS SYSTEM DIN 3113

	L	W	Φ	H	D			
HT1W490	8-19 mm						5	20

DE Kombinationszange EN Combination pliers FR Pince universelle ES Alicates universal HR Uniwerzalna kliješta HU Kombinált fogók RO Cleste combinat BG Клеци комбинирани



CrV HRC 58-62 DIN 5746 180° ERGO GRIP

	L	W	Φ	H	D			
HT1P006	160 mm						6	60
HT1P008	180 mm						6	60

DE Flachrundzange, gerade EN Long nose pliers FR Pince à bec long demi-rond ES Alicates de punta larga HR Kliješta izdužena, ravna HU Rádiós fogók RO Cleste cu varf lung BG Клеци угължени прави



CrV HRC 58-62 DIN 5745 180° ERGO GRIP

	L	W	Φ	H	D			
HT1P016	160 mm						6	60
HT1P020	200 mm						6	60

DE Halbrunde Zangen, gebogen EN Half-round bent pliers FR Pince à bec long demi-rond coudé ES Alicates de punta semirredonda acodado HR Klijesta izdužena, zakrivljena HU Hajlított rádiós fogók RO Cleste cu varf lung, curb BG Клеци "плоскоустни" угълени извити



CrV	HRC 58-62	DIN 5745	180°	ERGO GRIP
HT1P022	160 mm	6	60	
HT1P024	200 mm	6	60	

DE Halbrunde Zangen, gebogen EN Flat nose pliers FR Pince à bec long plat ES Alicates plano HR Plosonata klijesta HU Lapos hegyű rádiós fogók RO Cleste cu varf lung, plat BG Клеци "плоскоустни" прави



CrV	HRC 58-62	DIN 5745	180°	ERGO GRIP
HT1P026	160 mm	6	60	

DE Seegerringzange - innen, gerade EN Ring circlip pliers, internal straight FR Pince à circlips interne droite ES Alicates circlips interno recto HR Klijesta za pričvrstne prstenove - unutarnja, ravna HU Zégergyűrű fogó, belső egyenes RO Cleste cu falci rotunde, drept, intern BG Зегер клеци вътрешни прави



CrV				
HT1P145	150 mm	12-25 mm	6	60
HT1P141	180 mm	19-60 mm	6	60

DE Seegerringzange - innen, gekrümmt EN Ring circlip pliers, internal bent FR Pince à circlips interne coudée ES Alicates circlips interno acodado HR Klijesta za pričvrstne prstenove - unutarnja, ukošena HU Zégergyűrű fogó, belső hajlított RO Cleste cu falci rotunde, indoit, intern BG Зегер клеци вътрешни закривени



CrV				
HT1P147	150 mm	12-25 mm	10	60
HT1P143	180 mm	19-60 mm	6	60

DE Präzisions-Kombinationszange EN Precision universal pliers FR Pince universelle de précision ES Alicates de precisión universal HR Precizna univerzalna klijesta HU Precíziós univerzális fogók RO Cleste universal de precizie BG Прецизни комбинирани клеци



HRC 50-55	180°	ERGO GRIP	
HT1P050	125 mm	6	72

DE Präzisions-Seitenschneider EN Precision diagonal cutting plier FR Pince universelle de précision ES Alicates de corte diagonal de precisión HR Precizna bočna klijesta HU Precíziós oldalsíró fogó RO Cleste de taiere diagonala de precizie BG Прецизни клеци резачки



HRC 50-55	180°	ERGO GRIP	
HT1P052	115 mm	12	120

DE Seegerringzange - außen, gerade EN Ring circlip pliers, external straight FR Pince à circlips externe coudée ES Alicates circlips externo recto HR Klijesta za pričvrstne prstenove - vanjska, ravna HU Zégergyűrű fogó, külső egyenes RO Cleste cu falci rotunde, drept, extern BG Зегер клеци външни прави



CrV				
HT1P146	150 mm	10-25 mm	6	60
HT1P142	180 mm	19-60 mm	6	60

DE Seegerringzange - außen, gekrümmt EN Ring circlip pliers, external bent FR Pince à circlips externe coudée ES Alicates circlips externo acodado HR Klijesta za pričvrstne prstenove - vanjska, ukošena HU Zégergyűrű fogó, külső hajlított RO Cleste cu falci rotunde, indoit, extern BG Зегер клеци външни закривени



CrV				
HT1P148	150 mm	10-25 mm	6	60
HT1P144	180 mm	19-60 mm	6	60

DE Präzisions-Flachrundzange, gerade EN Precision long nose pliers FR Pince à bec long demi-rond de précision ES Alicates de punta larga de precisión HR Precizna izdužena klijesta, ravna HU Precíziós rádiós fogók RO Cleste cu varf lung de precizie BG Прецизни универсални клеци удължени



HRC 50-55	180°	ERGO GRIP	
HT1P054	130 mm	12	120

DE Halbrunde Präzisionszange, gebogen EN Precision bent pliers FR Pince à bec demi-rond de précision ES Alicates de punta semirredonda de precisión HR Precizna izdužena klijesta, zakrivljena HU Precíziós hajlított rádiós fogók RO Cleste cu varf lung, curbat, de precizie BG Прецизни универсални клеци узвити



HRC 50-55	180°	ERGO GRIP	
HT1P056	125 mm	6	72

DE Schweißzange, Typ „W“ EN Welding pliers type W FR Pincés à souder, type „W“ ES Alicates de soldadura, tipo „W“ HR Klijesta za zavarivanje, tip „V“ HU Hegesztő fogó - „W“ típus RO Cleste pentru sudura tip „W“ BG Клеци чираци заваръчни тип U-form



230 mm	W		
HT1P385	230 mm / 9"	10	40

DE Schweißzange, Typ „C“ EN Welding pliers type C FR Pincés à souder, type „C“ ES Alicates de soldadura, tipo „C“ HR Klijesta za zavarivanje, tip „C“ HU Hegesztő fogó - „C“ típus RO Cleste pentru sudura tip „C“ BG Клеци чираци заваръчни тип C-form



280 mm	C		
HT1P386	280 mm / 11"	10	40

DE Präzisions-Kombinationszange EN Precision end cutting pliers FR Pince coupante devant de précision ES Alicates de corte delantero de precisión HR Precizna čeona klijesta HU Precíziós homlokcsíró fogók RO Cleste de precizie cu taietura frontala BG Прецизни клеци керпеден



HRC 50-55	180°	ERGO GRIP	
HT1P058	115 mm	6	72

DE Allzweckwerkzeuge EN Multipurpose tool FR Pince multifonction ES Herramienta multifunción HR Višenamjenski alat HU Multi-funkciós szerszám RO Scule multifunctionale BG Мултифункционален съваем нож



2CR13	10 in 1		
HT1P070	110 mm	12	48

DE Schweißzange flach EN Flat welding pliers FR Pincés à souder plates ES Alicates de soldadura plana HR Klijesta za zavarivanje HU Hegesztő fogók - lapos pófával RO Cleste pentru sudura, plata BG Клеци чираци заваръчни широки челюсти



250 mm	FLAT		
HT1P387	240 mm	10	40

DE Drehschraubstock EN Rotary Vice FR Étau pivotant ES Tornillo de banco giratorio HR Okretni škripac HU Satu RO Menghine BG Менгеме с въртяща се основа



HT3B617	11 kg	125 mm	1	1
HT3B618	17 kg	150 mm	1	1
HT3B619	19,5 kg	200 mm	1	1

**HÖGERT**  
technik

DE Druckluft-Werkzeuge

EN Pneumatic Tools

FR Outils Pneumatiques

ES Herramientas Neumáticas

HR Pneumatski Alati

HU Pneumatikus Szerszámok

RO Instrumente Pneumatice

BG Пневматични Инструменти



DE Pressluftschlagschlüssel mini EN Impact wrench FR Clé à chocs pneumatique mini ES Llave neumática mini HR Pneumatski udarni ključ HU Pneumatikus ütve csavarozó behajtó RO Masina de insurubat cu impact BG Пневматичен ударен гайковерт



1/2"	JUMBO	AI	1 3/8"	L/R
90 PSI/ 6.3 BAR	142.5 l/min	8500 RPM	1.45 kg	
HT4R621	1000 Nm	1	10	

DE Pressluftschlagschlüssel EN Impact wrench FR Clé à chocs pneumatique ES Pistola neumática HR Pneumatski udarni ključ HU Pneumatikus ütve csavarozó behajtó RO Masina de insurubat cu impact BG Пневматична тресчотка



1/2"	TWIN HAMMER	ALUMINIUM COMPOSITE	1 3/8"	L/R
90 PSI/ 6.3 BAR	198 l/min	7000 RPM	2 kg	
HT4R622	610 Nm	1	10	

DE Pressluftschlagschlüssel EN Impact wrench FR Clé à chocs pneumatique ES Pistola neumática HR Pneumatski pištolj HU Pneumatikus ütve csavarozó behajtó RO Masina de insurubat cu impact BG Пневматична тресчотка



1/2"	ALUMINIUM COMPOSITE	1 3/8"	L/R	1/4"
90 PSI/ 6.3 BAR	155 l/min	8000 RPM	2.2 kg	
HT4R623	1500 Nm	1	10	

DE Pressluftschlagschlüssel EN Impact wrench FR Clé à chocs pneumatique ES Llave neumática HR Pneumatski udarni ključ HU Pneumatikus ütve csavarozó behajtó RO Masina de insurubat cu impact BG Пневматична тресчотка





3/4"	TWIN HAMMER	AI	1 3/8"	L/R
90 PSI/ 6.3 BAR	583 l/min	4600 RPM	7 kg	
HT4R625	2400 Nm	1	2	

DE Pressluftschlagschlüssel EN Impact wrench FR Clé à chocs pneumatique ES Llave neumática HR Pneumatski udarni ključ HU Pneumatikus ütve csavarozó behajtó RO Masina de insurubat cu impact BG Пневматична тресчотка



1/2"	JUMBO	108 mm	1.45 kg	90 PSI/ 6.2 BAR
10000 RPM	L/R	1 3/8"	113 l/min	
HT4R626	680 Nm	1	6	

DE Druckluft Ratschenschrauber EN Air ratchet wrench FR Hochet pneumatique ES Sonajero neumático HR Pneumatska čegrtaljka HU Pneumatikus racsnis behajtó RO Clichet pneumatic BG Пневматична тресчотка

1/2"	MAX 6.2 bar 90 PSI	142 l/min	max: 150 R.P.M.	L/R
262 mm	90 PSI/ 6.3 BAR	142 l/min	150 RPM	
HT4R630	61 Nm	5	20	

DE Drucklufterhandschleifer EN Air grinder FR Perceuse pneumatique ES Taladro neumático HR Pneumatska ravna brusilica HU Pneumatikus egyenes csiszoló RO Masina de slefuit pneumatica dreapta BG Пневматична шлайфмашина



Ø3-6 mm	MAX 6.2 bar 90 PSI	113 l/min		
max: 2200 R.P.M.	AI	1/4"		
HT4R650	173 mm	6 mm	5	20

DE Druckluft - Bohrmaschine EN Reversible air drill FR Perceuse pneumatique ES Taladro neumático HR Zračna bušilica HU Pneumatikus fúrógép RO Masina de gaurit pneumatica BG Пневматична бормашина



MAX 6.2 bar 90 PSI	142 l/min	max: 1800 R.P.M.	L/R	
MAX Ø10mm				
HT4R635	193 mm	3-10 mm	5	20

DE Drucklufterhandschleifer EN Air eccentric sander FR Pneumatska bušilica ES Perceuse pneumatique HR Pneumatska ekscentrična brusilica HU Pneumatikus excentrikus csiszoló RO Masina de polisat pneumatic BG Пневматичен ексцентършлайф



MAX 6.2 bar 90 PSI	113 l/min	max: 10000 R.P.M.	5 mm STROKE	
HT4R651	150 mm	1	10	

DE Druckluft Exzenterschleifer EN Air eccentric sander FR Ponceuse excentrique pneumatique ES Lijadora neumática excéntrica HR Ekscentrična polirka 150 mm sa spremnikom za prašinu HU Excentercsiszoló RO Cheie pneumatică BG Пневматичен ексцентършлайф



90 PSI/ 6.2 BAR	85 l/min	1/4"		
10 500 RPM	0.96 kg	5 mm STROKE		
HT4R652	150 mm	1	10	

DE Schlagschrauber-Steckschlüssel, kurz EN Impact socket, short FR Douille à choc impact, court ES Llave de impacto, corto HR Udarni nasadni ključ, kratak HU Pneumatikus dugókulcsok, rövid RO Chei de impact, mic de statura BG Ударна вложка къс



HT4R060	10 mm	20	120
HT4R061	11 mm	20	120
HT4R062	12 mm	20	120
HT4R063	13 mm	20	120
HT4R064	14 mm	20	80
HT4R065	15 mm	20	120
HT4R066	16 mm	20	120
HT4R067	17 mm	12	96
HT4R068	18 mm	12	96
HT4R069	19 mm	12	96
HT4R070	20 mm	12	96
HT4R071	21 mm	12	96
HT4R072	22 mm	10	80
HT4R074	24 mm	10	80
HT4R077	27 mm	8	48
HT4R080	30 mm	8	48
HT4R081	32 mm	8	48

DE Schlagschrauber-Steckschlüssel EN Impact socket, deep FR Douille à choc impact, longue ES Llave de impacto, larga HR Udarni nasadni ključ HU Pneumatikus dugókulcs RO Chei tubulare pneumatic de impact BG Ударна дълга вложка



HT4R010	10 mm	18	108
HT4R011	11 mm	18	108
HT4R012	12 mm	18	108
HT4R013	13 mm	18	108
HT4R014	14 mm	18	108
HT4R015	15 mm	18	108
HT4R016	16 mm	18	108
HT4R017	17 mm	14	84
HT4R018	18 mm	14	84
HT4R019	19 mm	14	84
HT4R020	20 mm	14	84
HT4R021	21 mm	14	84
HT4R022	22 mm	12	72
HT4R023	23 mm	8	48
HT4R024	24 mm	8	48
HT4R027	27 mm	6	36
HT4R030	30 mm	6	36
HT4R032	32 mm	6	36

DE Schlagschrauber-Steckschlüssels und Verlängerung EN Flip Impact socket set FR Jeu de douilles à choc bilatérales et de rallonges ES Juego de llaves de impacto de dos caras y prolongadores HR Garnitura udarnih nasadnih ključeva, dvostranih HU Kétoldalú pneumatikus dugókulcs készlet RO Trusa de chei tubulare cu doua carate BG Комплект ударни вложки, двустранни с удължител



x3	1/2"	17 mm 19 mm 21 mm 22 mm	75 mm	SUPER SLIM	CrMo
HT4R006	5	20			

DE Schlagschrauber-Steckschlüssels EN Impact socket set, thin wall FR Jeu de douilles à chocs ES Juego de llaves de impacto HR Garnitura udarnih nasadnih ključeva HU Hosszú pneumatikus dugókulcs készlet RO Trusa de chei tubulare lungi de impact BG Комплект ударни вложки thin wall



x3	1/2"	17 mm 19 mm 21 mm	78 mm	SUPER SLIM	CrMo
HT4R104	12	24			

DE Schlagschrauber-Steckschlüssels EN Impact socket set, deep FR Jeu de douilles à choc impact, longues ES Juego de llaves de impacto, largas HR Garnitura udarnih nasadnih ključeva HU Hosszú pneumatikus dugókulcs készlet RO Trusa de chei tubulare lungi de impact BG Комплект дълги ударни вложки



x15	1/2"	DEEP	CrMo	DIN 3121
HT4R049	1	4		

DE Schlagschrauber-Steckschlüssel, kurz EN Impact socket, short FR Douille à choc impact, court ES Llave de impacto, corto HR Udarni nasadni ključ, kratak HU Pneumatikus dugókulcsok, rövid RO Chei de impact, mic de statura BG Ударна вложка къс



HT4R141	19 mm	16	64
HT4R142	21 mm	16	64
HT4R143	22 mm	16	64
HT4R144	24 mm	16	64
HT4R145	27 mm	16	64
HT4R146	30 mm	12	48
HT4R147	32 mm	12	48
HT4R148	33 mm	8	32
HT4R149	34 mm	8	32
HT4R151	36 mm	6	24
HT4R152	38 mm	6	24
HT4R153	41 mm	4	16
HT4R154	46 mm	4	16
HT4R155	50 mm	2	8
HT4R156	55 mm	2	8
HT4R157	60 mm	2	8
HT4R158	65 mm	2	8

DE Schlagschrauber-Steckschlüssel, lang EN Impact socket, deep FR Douille à choc impact, longue ES Llave de impacto, larga HR Udarni nasadni ključ HU Pneumatikus dugókulcsok RO Chei de impact BG Ударна вложка дълга



Folder	Length	Width	Quantity
HT4R111	19 mm	6	24
HT4R112	21 mm	6	24
HT4R113	24 mm	6	24
HT4R114	27 mm	6	24
HT4R115	30 mm	6	24
HT4R116	32 mm	6	24
HT4R120	36 mm	6	24
HT4R122	41 mm	4	16
HT4R124	46 mm	4	16

3/4" DEEP CrMo DIN 3121

DE Schlagschrauber-Steckschlüssel, lang EN Impact socket, deep FR Douille à choc impact, longue ES Llave de impacto, larga HR Udarni nasadni ključ HU Pneumatikus dugókulcsok RO Chei de impact BG Ударна вложка дълга



Folder	Length	Width	Quantity
HT4R211	27 mm	4	16
HT4R212	30 mm	4	16
HT4R213	32 mm	4	16
HT4R214	33 mm	4	16
HT4R217	36 mm	4	16

1" DEEP CrMo DIN 3121

DE Schlag-Verlängerung EN Impact extension bar FR Extension rallonge à choc ES Prolongador llave de impacto HR Udarni produžetak HU Pneumatikus toldó adapter RO Prelungitor pentru chei tubulare de impact BG Ударен удължител



Folder	Length	Width	Quantity
HT4R302	75 mm	20	120
HT4R304	125 mm	20	80
HT4R306	250 mm	20	40

1/2" CrMo DIN 3121

DE Schlag-Verlängerung EN Impact extension bar FR Extension rallonge à choc ES Prolongador llave de impacto HR Udarno proširenje HU Pneumatikus toldó RO Extensii de impact BG Ударен удължител



Folder	Length	Width	Quantity
HT4R315	175 mm	4	16
HT4R316	250 mm	4	16

CrMo 3/4" DIN 3121

DE Schlag-Verlängerung EN Impact extension bar FR Extension rallonge à choc ES Prolongador llave de impacto HR Udarno proširenje HU Pneumatikus toldó RO Extensii de impact BG Ударен удължител



Folder	Length	Width	Quantity
HT4R320	250 mm	3	12

CrMo 1" DIN 3121

DE Schlagadapter EN Impact adapter FR Adaptateur à choc ES Adaptador para llave de impacto HR Udarni adapter HU Pneumatikus adapter RO Adaptor de impact BG Ударен адаптер



Folder	Length	Width	Quantity
HT4R324	F 1/2" x M 3/4"	14	84

CrMo DIN 3121 F 1/2" x M 3/4"

DE Schlagadapter EN Impact adapter FR Adaptateur à choc ES Adaptador para llave de impacto HR Udarni adapter HU Pneumatikus adapter RO Adaptor de impact BG Ударен адаптер



Folder	Length	Width	Quantity
HT4R326	F 3/4" x M 1"	6	24

CrMo DIN 3121 F 3/4" x M 1"

DE Schlagschrauber-Gelenk EN Impact universal joint FR Rotule universelle ES Rótula de bola universal HR Kuglasti zglob HU Golyós kulcs adapter RO Adaptor cu bila BG Универсален кардан



Folder	Length	Width	Quantity
HT4R328	67 mm	10	50

CrMo 1/2" DIN 3121

DE Druckluft-Schlagschrauber-Nuss Torx EN Bit impact socket torx set FR Jeu de 8 douilles à chocs Torx ES Juego de llaves de impacto, Torx HR Pinski ključevi torx, udarni HU Pneumatikus torx bit kulcsok RO Chei bit de impact torx BG Комплект вложки ударни torx



T30, T40, T45, T50, T55, T60, T70, T80

CrMo 1/2" x8

Folder	Quantity	Box
HT6R002	1	10

DE Druckluft-Schlagschrauber-Nuss Hex EN Bit impact socket hex set FR Jeu de 8 douilles à chocs Hex ES Juego de llaves de impacto, Hex HR Pinski ključevi hex, udarni HU Pneumatikus hex bit kulcsok RO Chei bit de impact hex BG Комплект вложки ударни hex



H6, H7, H8, H10, H12, H14, H17, H19

CrMo 1/2" x8

Folder	Quantity	Box
HT6R004	1	10

DE Druckluft-Schlagschrauber-Nuss Spline EN Bit impact socket spline set FR Jeu de 8 douilles à chocs Spline ES Juego de llaves de impacto Spline HR Pinski ključevi spline, udarni HU Pneumatikus bit kulcs készlet RO Trusa de chei bit de impact BG Комплект вложки ударни spline



M5, M6, M8, M10, M12, M14, M16, M18

CrMo 1/2" x8

Folder	Quantity	Box
HT6R006	1	10

DE Lackierpistole mit unterem Saugbecher EN Spray Gun FR Pistolet pulvérisateur de peinture ES Pistola de pintar HR Pištolj za prskanje HU Szórópisztoly RO Pistol de vopsit BG Пистолет за боядисване



1000 ml H.V.L.P. 14 mm 130-210 ml/min

43 PSI/3 BAR 1/4"

Folder	Quantity	Box
HT4R712	5	10

DE Lackierpistole mit oberem Saugbecher EN Spray Gun FR Mini Pistolet pulvérisateur de peinture ES Pistola de pintar HR Pištolj za prskanje HU Szórópisztoly RO Pistol de vopsit BG Пистолет за боядисване



100 ml H.V.L.P. 0.8 mm 70-110 l/min

30 PSI/2 BAR 1/4"

Folder	Quantity	Box
HT4R718	5	20

DE Lackierpistole mit oberem Saugbecher EN Spray Gun FR Pistolet pulvérisateur de peinture ES Pistola de pintar HR Pištolj za prskanje HU Szórópisztoly RO Pistol de vopsit BG Пистолет за боядисване



600 ml H.V.L.P. 14 mm 160-240 l/min

43 PSI/3 BAR 1/4"

Folder	Quantity	Box
HT4R716	5	10

DE Austauschbare Düse zur Lackierpistole EN Replacement nozzle for spray gun FR Buse de rechange pour pistolet de peinture ES Boquilla de repuesto para la pistola HR Izmjenjiva mlaznica za pištolj za lakiranje HU Pótfúvóka szórópisztolyokhoz RO Duza de schimb pentru pistol de pulverizare BG Резервна дюза



Fits to: HT4R712 HT4R716

Folder	Length	Width	Quantity
HT4R746	1,7 mm	25	50
HT4R747	2,0 mm	25	50

DE Austauschbare Düse zur Lackierpistole EN Replacement nozzle for spray gun FR Buse de rechange pour pistolet de peinture ES Boquilla de repuesto para la pistola HR Izmjenjiva mlaznica za pištolj za lakiranje HU Pótfúvóka szórópisztolyokhoz RO Duza de schimb pentru pistol de pulverizare BG Резервна дюза



Fits to: HT4R718

Folder	Length	Width	Quantity
HT4R748	0,8 mm	25	50
HT4R749	1,2 mm	25	50



**DE** Blaspistole, kurze und lange Düse **EN** Air blow gun **FR** Soufflette buse courte et longue **ES** Pistola de dar aire, boquilla corta y larga **HR** Pištolj za puhanje **HU** Légfúvó pisztoly **RO** Pistol de vopsit aerograf (Air Blow) **BG** Пистолет за въздух



26.5 mm / 127.0 mm	87 PSI / 6 BAR	2.0 mm / 3.6 mm	1/4"	HT4R750	20	40
--------------------	----------------	-----------------	------	---------	----	----

**DE** Gebläsepistole mit verlängerung **EN** Air blow gun **FR** Pistolet à air comprimé **ES** Pistola de aire para soplar **HR** Pištolj za puhanje **HU** Sűrített levegős pisztoly **RO** Pistol cu aer comprimat **BG** Пистолет за въздух



200 mm	116 PSI / 8 BAR	2.5 mm	1/4"	HT4R751	10	40
--------	-----------------	--------	------	---------	----	----

**DE** Reinigungspistole **EN** Cleaning gun **FR** Pistolet de nettoyage **ES** Pistola de aire a presión. **HR** Pištolj za čišćenje **HU** Tisztító pisztoly **RO** Pistol de suflat **BG** Почистващ пистолет



900 ml	43-58 PSI / 3-4 BAR	4.5 mm	1/4"	HT4R755	10	20
--------	---------------------	--------	------	---------	----	----

**DE** Reifenfüllpistole **EN** Inflating gun **FR** Pistolet de pompe **ES** Pistola para inflado **HR** Pištolj za pumpanje **HU** Felfújó fej **RO** Pistol de umflat **BG** Пистолет за надуване



450 mm	0-12 BAR / 0-174 PSI	1/4"	8 mm	HT4R757	10	40
--------	----------------------	------	------	---------	----	----

**DE** Reifenfüller **EN** Inflating gun **FR** Pistolet de gonflage **ES** Pistola de aire para inflar larga **HR** Pištolj za pumpanje **HU** Felfújó fej **RO** Pistol de umflare **BG** Пистолет за надуване



450 mm	0-12 BAR / 0-174 PSI	1/4"	8 mm	HT4R758	10	40
--------	----------------------	------	------	---------	----	----

**DE** Schnellkupplung **EN** Quick coupler **FR** Connecteur rapide **ES** Conector rápido **HR** Konektor **HU** Adapter csatlakozó **RO** Adaptor cuplaje **BG** Бърз съединител



15 BAR / 217 PSI	1/4"	HT4R801	F 1/4"	50	100
		HT4R802	M 1/4"	50	100
		HT4R803	M 6,3 mm	50	100
		HT4R804	M 12,5 mm	50	100

**DE** Endstück für Schnellkupplung **EN** Quick coupler tip **FR** Embouts de tuyau **ES** Terminal para manguera **HR** Završetak za konektor **HU** Csatlakozó adapter végelem **RO** Adaptor cuplaje, terminal **BG** Адаптер за маркуч



15 BAR / 217 PSI	1/4"	x2	HT4R810	F 1/4"	50	100
			HT4R811	F 1/4"	50	100
			HT4R812	M 6,3	50	100
			HT4R813	M 12,5	50	100

**DE** Kupplung **EN** Coupler **FR** Connecteur **ES** Conector **HR** Konektor z tuljcem **HU** Tömítőcsatlakozó **RO** Cuplaj furtun **BG** Съединител



7.2 mm	15 BAR / 217 PSI	HT4R820	7,2 mm / 8-12 mm	50	100
--------	------------------	---------	------------------	----	-----

**DE** Schnellkupplung **EN** Quick coupler **FR** Connecteur rapide **ES** Conector rápido **HR** Konektor z tuljcem **HU** Tömítőcsatlakozó **RO** Cuplaj furtun **BG** Съединител



7.2 mm	15 BAR / 217 PSI	HT4R821	7,2 mm / 8-12 mm	50	100
--------	------------------	---------	------------------	----	-----

**DE** Druckfilter-Druckminderer **EN** Air filter-reducer **FR** Filtre à Air avec manomètre **ES** Filtro de aire con manómetro **HR** Filter zraka **HU** Légszűrő nyomásmérővel **RO** Filtru linie aer cu manometru **BG** Пневматичен филтър с манометър



9 BAR / 135 PSI	1/4"	15 cm <sup>3</sup>	90 cm <sup>3</sup>	HT4R871	15 cm	5	20
				HT4R872	90 cm	10	20

**DE** Druckfilter-Druckminderer und Entöler **EN** Air filter-reducer and lubricator **FR** Filtre régulateur lubrificateur avec manomètre **ES** Filtro del pulverizador de aceite, con manómetro **HR** Filter zraka **HU** Levegőszűrő nyomásmérővel **RO** Filtru linie aer cu manometru **BG** Пневмогрупа: пневматичен филтър с регулатор с омаслител



9 BAR / 135 PSI	1/4"	25 cm <sup>3</sup> / 15 cm <sup>3</sup>	HT4R874	5	20
-----------------	------	---	---------	---	----

**DE** Filter **EN** Air filter **FR** Mini Filtre à Air **ES** Mini filtro de aire **HR** Mini filter **HU** Légszűrő **RO** Filtru linie aer **BG** Пневматичен филтър



14 BAR / 203 PSI	1/4"	8 cm <sup>3</sup>	HT4R870	10	50
------------------	------	-------------------	---------	----	----

**DE** Druckminderer **EN** Reducer **FR** Régulateur avec un manomètre **ES** Regulador con manómetro **HR** Regulator s manometrom **HU** Szabályozó nyomásmérővel **RO** Regulator cu manometru **BG** Пневматичен регулатор с манометър



12 BAR / 174 PSI	1/4"	HT4R873	20	60
------------------	------	---------	----	----

**DE** Druckfilter-Druckminderer und Entöler **EN** Air filter-reducer and lubricator **FR** Filtre régulateur lubrificateur **ES** Filtro de aire con reductor y pulverizador de aceite **HR** Filter zraka **HU** Levegőszűrő nyomásmérővel **RO** Filtru linie aer cu manometru **BG** Пневмогрупа: пневматичен филтър с регулатор с омаслител



9 BAR / 135 PSI	1/4"	90 cm <sup>3</sup> / 60 cm <sup>3</sup>	HT4R875	5	10
-----------------	------	---	---------	---	----

**DE** Entöler **EN** Lubricator **FR** Mini Graisseur à brouillard d'huile **ES** Mini pulverizador de aceite **HR** Mini podmazivač **HU** Levegőtömlő kenő **RO** Gresat pentru furtun cu aer **BG** Омаслител



9 BAR / 135 PSI	1/4"	HT4R876	25	50
-----------------	------	---------	----	----

**DE** Druckluftschlauch **EN** Pressure air hose **FR** Tuyau de pression **ES** Manguera de presión **HR** Tlačno crijevo **HU** Légtömlő **RO** Furtunuri de aer **BG** Маркуч за компресор



HT4R890	5	8	6	1	50
HT4R891	10	8	6	1	25
HT4R892	15	8	6	1	25
HT4R894	9	12	8	1	25

DE KFZ-Werkzeuge  
EN Automotive Tools  
FR Outils Automobiles  
ES Herramientas De Automoción  
HR Alati Za Automobile  
HU Járműipari Szerszámok  
RO Scule Auto  
BG Автомобилни Инструменти



**DE** Hydraulischer Rangierwagenheber **EN** Floor jack, low profile **FR** Ascenseur hydraulique **ES** Gato hidráulico de ruedas **HR** Hidraulična dizalica niskog profila **HU** Alacsony profilú hidraulikus emelő **RO** Cricuri hidraulice cu profil redus **BG** Нископрофилен хидравличен крик



**HT8G004**

2 T	89	359	1	1
-----	----	-----	---	---

LOW PROFILE x2 x2

**DE** Hydraulischer Rangierwagenheber **EN** Floor jack, low profile **FR** Ascenseur hydraulique **ES** Gato hidráulico de ruedas **HR** Hidraulična dizalica niskog profila **HU** Alacsony profilú hidraulikus emelő **RO** Cricuri hidraulice cu profil redus **BG** Нископрофилен хидравличен крик



**HT8G006**

2.5 T	85	455	1	1
-------	----	-----	---	---

LOW PROFILE x2 x2

**DE** Hydraulischer Stempelwagenheber **EN** Hydraulic bottle jack **FR** Cric hydraulique **ES** Gato hidráulico **HR** Jednostupna dizalica u jednom segmentu **HU** Hidraulikus üveg alakú emelő **RO** Cric hidraulic forma de sticla **BG** Подсилен бутилков хидравличен крик



**HT8G022**

5 T	210	405	1	4
8 T	225	440	1	4

**DE** Unterstellböcke **EN** Jack stand **FR** Chandelles auto **ES** Borriqueta para coche **HR** Automobilska potpora **HU** Autó emelő állvány **RO** Stand de ridicat auto **BG** Подпори за крик



**HT8G052**

2 T	268	418	1	1
3 T	276	420	1	1
6 T	388	580	1	1

**DE** Werkstattliege **EN** Workshop couch **FR** Chariot de visite **ES** Camilla para mecánico **HR** Ležaljka za radionicu **HU** Műhely kanapé **RO** Canapea de atelier **BG** Автомонтьорска лeжанка



**HT8G100**

1010 x 470 mm	1	1
---------------	---	---

max 110 kg PE-HD 40" x6 Ø63 115 mm

**DE** Kreuzschlüssel **EN** Wheel wrench **FR** Clé démonte-roue **ES** Llave para ruedas **HR** Ključ za kotače **HU** Kerékkulcs **RO** Cheie roata auto **BG** Кръстат ключ



**HT8G310**

350 mm	1	20
--------	---	----

1/2" 17/19/21 mm STEEL

**DE** Kreuzschlüssel **EN** Foldable wheel wrench **FR** Clé démonte-roue pliable **ES** Llave para ruedas plegable **HR** Ključ za kotače na sklapanje **HU** Összehajtható kerékkulcs **RO** Cheie roata auto plianta **BG** Кръстат ключ съваем



**HT8G311**

450 mm	1	10
--------	---	----

1/2" 17/19/21 mm CrV

**DE** Digitales Reifendruckmessgerät **EN** Digital tire pressure gauge **FR** Manomètre numérique pour pneumatiques **ES** Medidor digital de presión de neumáticos **HR** Digitalni mjerač guma **HU** Digitális gumiabroncsmérő **RO** Gabarit digital de anvelope **BG** Цифров манометър за налягане в гумите

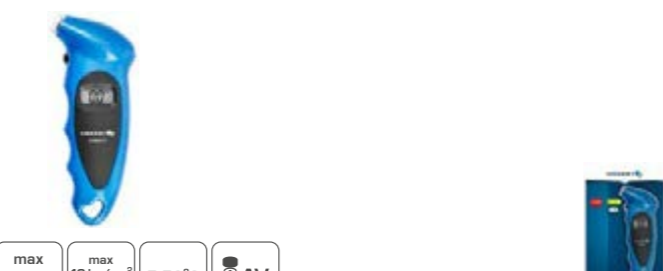

**HT8G314**

2-150 PSI	12	144
-----------	----	-----

max 150 PSI 10 BAR max 10 kg/cm² 1000 kPa 5-50°C PSI-BAR kg/cm² kPa 1-3 V CR2032 3 x 1.5 V LR44 +/- 1.5% LED LIGHT

**DE** Drehmomentschlüssel für Gummi- und Metallventile **EN** Dynamometric key for rubber and metal valves **FR** Clé dynamométrique pour soupapes en caoutchouc et métalliques **ES** Llave dinamométrica para válvulas de neumáticos **HR** Ključ za zakretni moment za gumene i metalne ventile **HU** Kulcs gumi és fém szelepekhez **RO** Cheie pentru supape din cauciuc si metal **BG** Ключ за гумени и метални клапани



**HT8G317**

1	250
---	-----

RUBBER STEEL CLIMA AV

**DE** Reifenheber **EN** Tyre bead breaker **FR** Démonte-pneu **ES** Palanca para neumáticos **HR** Žlica za gume **HU** Gumiabroncs feszítő kulcs **RO** Dispozitiv de scoatere a anvelopei auto **BG** Щанга за гуми



**HT8G315**

400 mm	25	50
500 mm	25	50

CrV DROP FORGED

**DE** Scheibenbremsenspreizer **EN** Disc brake separation **FR** Séparateur pour freins à disques **ES** Separador de pistones de freno **HR** Odvajač za disk kočnice **HU** Tárcsafél elválasztó **RO** Separator de frana cu disc **BG** Сепаратор за спирачни апарати



**HT8G372**

1	30
---	----

13-87 mm 1/2"

**DE** Pneumatischer Abscheider für Bremssättel **EN** Pneumatic brake caliper fawind tool kit **FR** Séparateur d'étrier de frein pneumatique **ES** Separador de pinza de freno neumático **HR** Pneumatski separator čeljusti kočnice **HU** Pneumatikus féknyereg-elválasztó **RO** Separator de etrier pneumatic de frână **BG** Комплект пневматичен сепаратор за спирачни системи



**HT4R780**

1	5
---	---

x4 6 BAR 91 PSI 20-35 mm 2/3 PIN L/R

**DE** Drehmomentschlüssel für Ventile **EN** Torque wrench for valves **FR** Clé dynamométrique pour vannes **ES** Llave dinamométrica para válvulas **HR** Moment ključ za ventile **HU** Nyomatékkulcs szelepekhez **RO** Cheie dinamometrică pentru supape **BG** Ключ динамометричен за клапани



**HT8G318**

max 0,25 Nm	50	100
max 0,45 Nm	50	100

RUBBER STEEL CLIMA AV

**DE** Auswuchtgewichtzange **EN** Wheel balance pliers **FR** Pince pour équilibrage des roues **ES** Alicata para equilibrado de ruedas **HR** Klješta za balansiranje kotača **HU** Kerékgyensúly beállító fogó **RO** Cleste de balansare a rotilor **BG** Клещи - чук за тежести за баланс на гуми



**HT8G348**

10	50
----	----

STEEL LENGTH 240 mm

**DE** Bremskolben-Rückstellsatz **EN** Universal caliper wind back kit **FR** Set reposse-piston pour étriers de freins **ES** Juego de montaje de pistones de freno **HR** Set odvajača za kočnice **HU** Univerzális féknyereg szélvédő készlet **RO** Set universal de etrier pentru vant **BG** Комплект сепаратор за спирачни системи

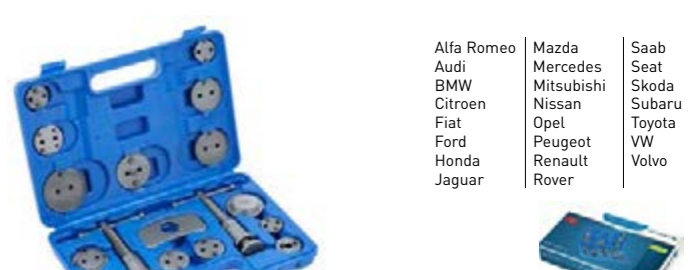

**HT8G374**

1	5
---	---

x18

- Alfa Romeo
- Audi
- BMW
- Citroen
- Fiat
- Ford
- Honda
- Jaguar
- Mazda
- Mercedes
- Mitsubishi
- Nissan
- Opel
- Peugeot
- Renault
- Rover
- Saab
- Seat
- Skoda
- Subaru
- Toyota
- VW
- Volvo

**DE** Universalabscheider für Bremssättel **EN** Universal separators for brake calipers **FR** Séparateurs universels pour étriers de frein **ES** Separadores universales para pinzas de freno **HR** Univerzalni separatori za čeljusti kočnica **HU** Univerzális elválasztók féknyereghez **RO** Separatoare universale pentru etrierele de frână **BG** Универсалени сепаратори за спирачен апарат



**HT8G376**

10	50
----	----

4 mm 3/8" VAG EPB Electronic Park Brake 2/3 PIN

**DE** Universaler Bremsattel Schlüssel **EN** Disc brake piston tool **FR** Clé universelle pour étrier des freins **ES** Llave universal para pinzas de freno **HR** Univerzalni ključ za kočione stezaljke **HU** Tárcsafék dugattyú szerszám **RO** Instrument cu piston de frana cu disc **BG** Универсален ключ за спиращен апарат



10 mm	3/8"	CrMo			
HT8G373	25	100			

**DE** Bremsschlauchbieger **EN** Brake hose bender **FR** Cintreuse de tuyaux de frein **ES** Curvadora para tubos de freno **HR** Savijač kočionih crijeva **HU** Féktömlő hajlító **RO** Îndoitor furtun frână **BG** Инструмент за огъване на метални кабели



∅   
4.75, 6.35, 7.95; 9.53 mm  
3/16", 1/4", 5/16", 3/8"



4.75 - 9.53 mm	for tubes Cu, Al			
HT8G375	1	1		

**DE** Bremsflüssigkeits-Tester **EN** Brake fluid tester **FR** Testeur de liquide de frein **ES** Comprobador de líquido de frenos **HR** Ispitivač kočione tekućine **HU** Fékfolyadék-tesztelő **RO** Tester de lichid de frână **BG** Тестер за спираща течност



DOT 3/4/5	9V			
HT8G433	1	56		

**DE** Federspanner **EN** Spring puller **FR** Compresseur de ressorts **ES** Extractor para muelles **HR** Izvlakač za opruge **HU** Rugó lehúzó **RO** Instrument de racla **BG** Скоби за пружини



×2		21 mm	1/2"	DROP FORGED	TRAPEZOIDAL THREAD		355 mm			
HT8G245	1	10								

**DE** Satz zum Austausch von Bremsbacken **EN** Brake tool set **FR** Set de remplacement des mâchoires des freins **ES** Juego de herramientas para zapatos de freno **HR** Komplet za zamjenu kočnih cipela **HU** Fékrofa cserekészlet **RO** Set de inlocuire sabot de frana **BG** Комплект за смяна на спиращи челюсти



×8	for DRUM BRAKE	LENGTH 325 mm			
HT8G371	1	5			

**DE** Unterdruckpumpe für das Bremssystem **EN** Vacuum pump for the brake system **FR** Pompe à dépression pour système de freinage **ES** Bomba de vacío para sistema de frenado **HR** Vakuumpumpa za kočioni sustav **HU** Vákuumszivattyú a fékrendszerekhez **RO** Pompa de vid pentru sistemul de franare **BG** Ръчна вакуум помпа за спираща система



×16	1 BAR 15 PSI	4 BAR 58 PSI			
HT8G370	5	10			

**DE** Bremsflüssigkeitstester manuell **EN** Brake fluid tester **FR** Testeur de liquide de frein manuel **ES** Comprobador de líquido de frenos manual **HR** Ispitivač tekućine za ručnu kočnicu **HU** Kézi fékfolyadék-tesztelő **RO** Tester manual de lichid de frana **BG** Тестер за спираща течност ръчен



DOT 3/4/5			
HT8G434	1	60	

**DE** Federspanner **EN** Spring puller **FR** Compresseur de ressorts **ES** Extractor para muelles **HR** Izvlakač za opruge **HU** Rugó lehúzó **RO** Instrument de racla **BG** Скоби за пружини



×3		24 mm	DROP FORGED	TRAPEZOIDAL THREAD		305 mm			
HT8G246	1	8							

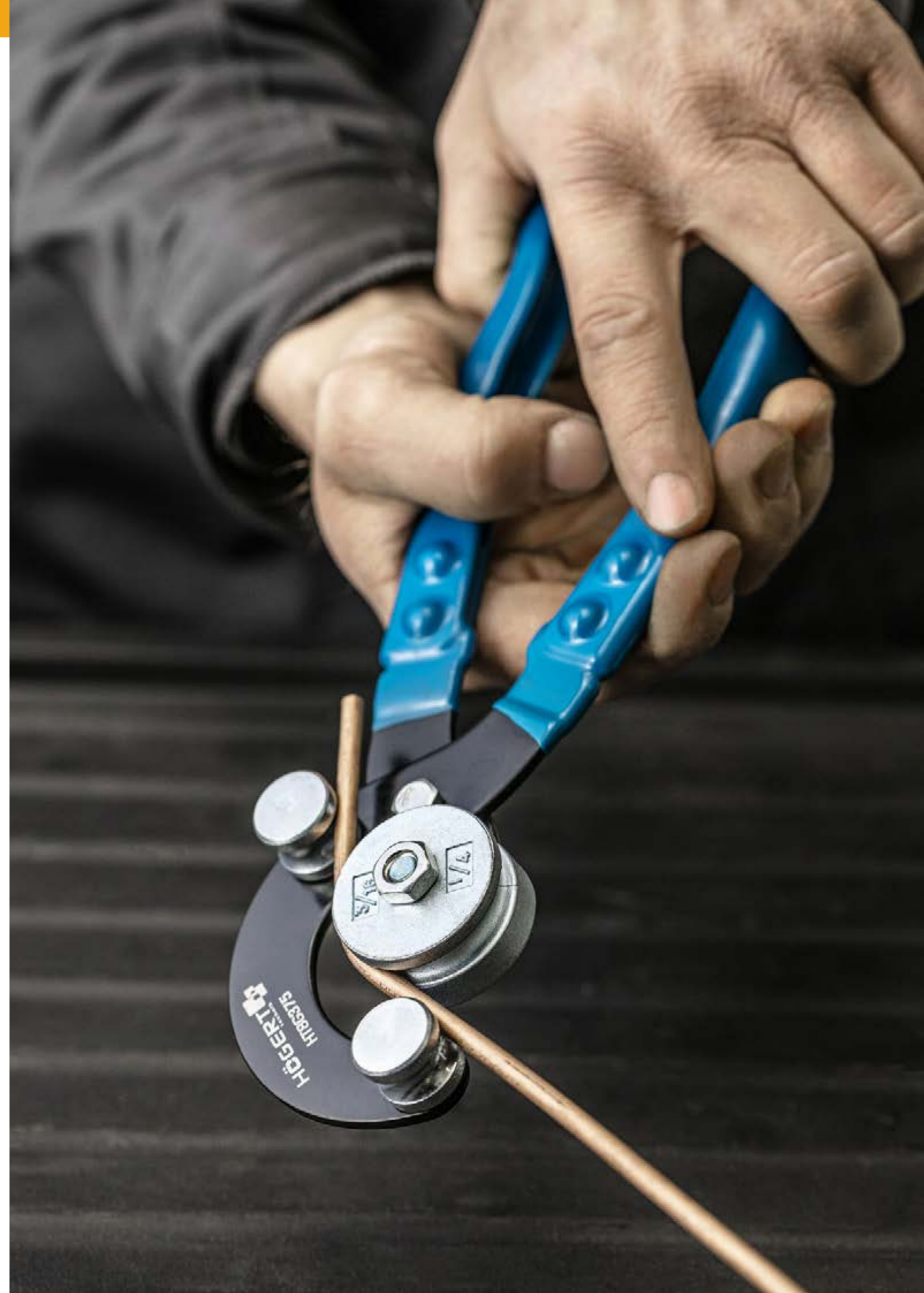

DE Federspanner EN Spring puller FR Compresseur de ressorts ES Extractor para muelles HR Izvlakač za opruge HU Rugó lehűző RO Instrument de racla BG Скоби за пружини



x2	24 mm	DROP FORGED	TRAPEZOIDAL THREAD	305 mm
HT8G247	1	20		

DE McPherson Federspanner EN McPherson spring puller FR McPherson Compresseur de ressorts ES Extractor de muelles McPherson HR McPherson izvlakač opruge HU McPherson rugóhűző RO Extractor de arc McPherson BG Скоби за пружини (макферсон)





max 2300 kg	100x265 mm	CrMo
HT8G248	1	2

DE Abzieher, zweiarmig EN Double-arm puller FR Extracteur 2 griffes ES Extractor de rodamientos 2-brazos HR Izvlakač 2-kraki HU Kétkaros lehűző RO Instrument de raclet cu doua brate BG Скоба двураменна



	max mm	max mm		
HT8G200	75	60	1	40
HT8G201	100	70	1	20
HT8G202	150	120	1	10
HT8G203	200	175	1	5

DE Zweiarmer Abzieher EN Two arm bearing puller FR Extracteur de roulements à deux griffes ES Extractor de rodamientos, de dos brazos HR Izvlakač ležajeva, 2 kraka HU Két csapághűző RO Extractor cu două brațe BG Скоба за вадене на лагери двураменна



	max mm	max mm	kN max		
HT8G215	40	60	10	1	100
HT8G216	65	65	12	1	100
HT8G217	80	80	15	1	100

DE Balken-Zuggerät, zweiarmig EN Crosshead double-arm puller FR Extracteur 2 griffes, auto-serrant ES Extractor de rodamientos de puente trasero 2 brazos HR Izvlakač 2-kraki, s gredom HU Keresztfejjű kétkaros lehűző RO Dispozitiv de extragere cu brat dublu BG Скоба двураменна



	max mm	max mm		
HT8G210	80	100	1	28
HT8G211	120	100	1	28
HT8G212	150	150	1	9
HT8G213	180	150	1	9

DE Abzieher, dreiarmig EN Three-arm puller FR Extracteur 3 griffes ES Extractor de rodamientos 3-brazos HR Izvlakač 3-kraki HU Háromkaros lehűző RO Instrument de raclet cu trei brate BG Скоба трираменна

	max mm	max mm		
HT8G205	75	60	1	40
HT8G206	100	70	1	20
HT8G207	150	120	1	6
HT8G208	200	175	1	4

DE Zweiarmsabzieher und Abscheider EN Two-arm puller and separator FR Extracteur et séparateur à deux bras ES Extractor y separador de dos brazos HR Dvokraki izvlakač i separator HU Kétkaros lehűző és elválasztó RO Extragerie și separator cu două brațe BG Сепаратор и скоба двураменна за лагери комплект



HT8G254	5 - 60 mm	1	10	
HT8G255	12 - 75 mm	1	10	
HT8G256	22 - 115 mm	1	2	

DE Zweiarmsabzieher und Abscheider EN Two-arm puller and separator set FR Extracteur et séparateur à deux bras ES Extractor y separador de dos brazos HR Dvokraki izvlakač i separator HU Kétkaros lehűző és elválasztó RO Extragerie și separator cu două brațe BG Сепаратор на лагери





HT8G257	30-75 mm	1	4	

DE Abzieher EN Bearing puller FR Extracteur de roulement ES Extractor de rodamientos HR Izvlakač HU Fogaskerék-hűző RO Tragator BG Скоба за вадене на лагери





CrV	12x38 mm	TRAPEZOIDAL THREAD	
HT8G218	12-38 mm	1	20

DE Pneumatische Vorrichtung zur Montage der Gelenkabdeckungen EN Pneumatic CV joint boot install tool FR Dispositif pneumatique pour le montage des couvercles des articulations ES Dispositivo neumático para el montaje de las tapas de las juntas. HR Pneumatski uređaj za postavljanje poklopaca spojeva HU Pneumatikus eszköz az ízületek burkolatának felszereléséhez RO Dispozitiv pneumatic pentru montarea caracelor rosturilor BG Пневматичен инструмент за монтаж на маншони на място

20-150 mm	VAG	8 arms
HT4R781	1	4

DE Abzieher für Wischerarme und Batterieklemmen EN Puller for wiper arms and battery terminals FR Extracteur de bras d'essuie-glace et de bornes de batterie ES Extractor de brazos de limpiaparabrisas y terminales de batería HR Izvlakač za skidanje brisača i stezaljki akumulatora HU Lehűző szerszám ablaktörölő karokhoz és az akkumulátor pólusaihoz RO Extractor pentru brațele ștergătorului și bornele bateriei BG Скоба за работата на четачките

28 mm	DEPTH 43 mm	STEEL	NYLON
HT8G251	1	1	

DE Gelenkabzieher EN Joint puller FR Extracteur des rotules ES Extractor para rodamientos de bolas de transmisiones HR Izvlakač za zglobove HU Speciális lehűző RO Extrageria articulatiilor BG Скоба за шарнири универсална



	max mm	max mm		
HT8G225	27	45	1	20
HT8G226	30	64	1	20

DE Kugelgelenkabzieher EN Ball joint puller FR Extracteur des rotules ES Extractor para rodamientos de bolas de transmisiones HR Izvlakač za zglobove HU Speciális lehűző RO Extrageria articulatiilor BG Скоба за шарнири универсална



	max mm	max mm		
HT8G231	20	62	1	20
HT8G232	17	58	1	20

DE Kugelgelenkabzieher EN Ball joint puller FR Extracteur des rotules ES Extractor para rodamientos de bolas de transmisiones HR Izvlakač za zglobove HU Speciális lehűző RO Extrageria articulatiilor BG Скоба за шарнири универсална



	max mm	max mm		
HT8G230	19	45	1	50

DE Trenn- und Montagegabel EN Ball joint puller FR Extracteur des rotules ES Desmontable para transmisiones HR Vilica za odvajanje zglobova HU Csukslós rögzítő RO Element de fixare BG Вилница за шарнири





	max mm	mm		
HT8G240	22	300	1	20
HT8G241	27	300	1	20
HT8G242	18	400	1	20

DE Radnaben Abzieher Satz EN Hub puller FR Extracteur de moyeux ES Extractor de cubos HR Izvlakač čvorišta HU Kerékagy lehűző RO Extragerie butuc BG Скоби за демонтаж на главина

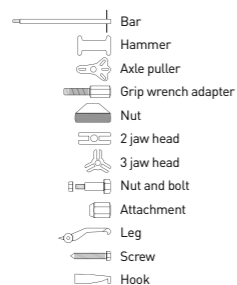

x13	DROP FORGED	95/75/45 mm	127 mm	TRAPEZOIDAL THREAD
HT8G250	1	10		

**DE** Nabe und Lagerabzieher **EN** Hub and bearing puller **FR** Extracteur de moyeu et de roulement **ES** Extractor de cubos y cojinetes **HR** Izvlakač glavčine i ležaja **HU** Agy és csapágyhúzó **RO** Butuc și extragere rulment **BG** Обратен чук (екстрактор) за главини и лагери



x16 8 in1 2.5 kg 57 cm

HT8G258	1	1
---------	---	---

**DE** Spurstangenschlüssel **EN** Steering rod wrench **FR** Clé pour biellettes de direction **ES** Llave de barra de de dirección **HR** Ključ za štap upravljača **HU** Kormányrúd kulcs **RO** Cheie pentru ghidon **BG** Ключ за кормилни накрайници



1/2" 35-42 mm STEEL

HT8G322	1	24
---------	---	----

**DE** Spurstangengelenk Werkzeug **EN** Steering rod puller set **FR** Extracteur de tige de direction **ES** Extractor de varilla de dirección **HR** Upravljača štap tegljač **HU** Kormányrúd telepítő keszlet **RO** Extragere tijă de direcție **BG** Ключ за демонтаж на кормилни накрайник



1/2" 32 mm x4 30-35 mm 35-40 mm 40-45 mm

HT8G229	410 mm	30-45 mm	1	4
---------	--------	----------	---	---

**DE** Lambdasondenschlüssel **EN** Lambda probe key **FR** Clé pour sonde Lambda **ES** Llave para sonda Lambda **HR** Ključ za sondu Lambda **HU** Lambda szonda kulcs **RO** Cheie sonde lambda **BG** Ключ за лямбда сонда



3/8" 22 mm LENGTH 80 mm 8 mm CrV

HT8G324	1	50
---------	---	----

**DE** Abzieher des vorderen Nabenlagers **EN** Front hub bearing puller **FR** Extracteur de roulement de moyeu avant **ES** Extractor de cojinetes de buje delantero **HR** Izvlakač ležaja prednje glavčine **HU** Első agy csapágyhúzó **RO** Extractor pentru lagăre hub-uri frontale **BG** Скоби за демонатаж на главина пред



x23 50x88 mm

HT8G253	1	2
---------	---	---

**DE** Spurstangengelenk Werkzeug **EN** Steering rod puller **FR** Extracteur de tige de direction **ES** Extractor de varilla de dirección **HR** Upravljača štap tegljač **HU** Kormányrúd telepítő keszlet **RO** Extragere tijă de direcție **BG** Ключ за демонтаж на кормилни накрайник



1/2" 27 mm

	mm	mm		
HT8G227	395 mm	28-35 mm	1	6
HT8G228	400 mm	35-45 mm	1	6

**DE** Lambdasondenschlüssel **EN** Lambda probe key **FR** Clé pour sonde Lambda **ES** Llave para sonda Lambda **HR** Ključ za sondu Lambda **HU** Lambda szonda kulcs **RO** Cheie sonde lambda **BG** Ключ за лямбда сонда



1/2" 22 mm LENGTH 50 mm for VW, BMW, Audi, Ford, Skoda, SEAT CrMo

HT8G323	15	60
---------	----	----

**DE** Lambdasondenschlüssel **EN** Lambda probe key **FR** Clé pour sonde Lambda **ES** Llave para sonda Lambda **HR** Ključ za sondu Lambda **HU** Lambda szonda kulcs **RO** Cheie sonde lambda **BG** Ключовеца лямбда сонда



x3 1/2" 3/8" 22 mm CrV CrMo

HT8G325	1	20
---------	---	----



**DE** Steckschlüsselsatz für Lambda-sonde und Injektoren **EN** Set of socket wrenches for lambda probe **FR** Set de clés à douilles pour sonde Lambda et injecteurs **ES** Juego de llaves de vaso para sonda Lambda y inyector **HR** Komplet nasadnih ključeva za Lambda sondu i brizgaljke **HU** Lambda szonda kulcs és injektor kulcs készlet **RO** Set de chei tubulare pentru sonda lambda si injectoare **BG** Комплект за лямбда сонда и инжектори



mm	mm	mm	mm	mm	mm
22	3/8"	30	80		
22	1/2"	50	60		
22	3/8" 27mm	90	-		
22	3/8" 27mm	80	-	1	10
27	3/8" 30mm	75	-		
29	1/2"	90	-		
27	1/2"	80	-		

×7  
1/2" 3/8" CrV CrMo

**DE** Ölfilterschlüssel **EN** Oil filter wrench **FR** Clé pour filtre à huile **ES** Llave para filtros de aceite **HR** Ključ za filter ulja **HU** Olajszűrő kulcs **RO** Cheie filtru ulei **BG** Ключ за маслен филтър



STEEL

mm	mm	mm	mm
HT8G301	60-73	12	48
HT8G302	73-85	12	48
HT8G303	85-95	12	48
HT8G304	95-111	12	48

**DE** Universal-Ölfilterschlüssel **EN** Universal oil filter wrench **FR** Clé pour filtre à huile universelle **ES** Llave universal para filtros de aceite **HR** Ključ za filter ulja univerzalan **HU** Multifunkciós olajszűrő kulcs **RO** Cheie filtru ulei multifunctional **BG** Ключ универсален за маслен филтър



STEEL 3/8" 1/2" 21 mm 65x120 mm

mm	mm	mm
HT8G305	1	40

**DE** Ölabblasschlüssel **EN** Oil drain plug keys **FR** Clés de vidange **ES** Llave para vaciado del aceite **HR** Ključevi za ispuštanje ulja **HU** Leeresztő dugó kulcsok **RO** Chei cu dop de golire **BG** Вложки за картерни пробки



×18 3/8" CrV

- 165 mm
- 7, 8, 10, 11, 12, 13, 14
- 5/16", 3/8"
- 8, 9, 10, 12, 14, 17
- 10
- 10

mm	mm	mm
HT8G321	1	10

**DE** Ölfilterschlüssel 14 Stk **EN** Oil filter wrenches **FR** Clés à filtre à huile 14 pièces **ES** Llaves para filtros de aceite 14 piezas **HR** Ključevi za filtere za ulje 14 kom **HU** Olajszűrő kulcsok 14 db **RO** Chei filtru ulei 14 buc **BG** Ключове за маслен филтър



×14 3/8" 1/2" 65x100 mm STEEL

- 65/14 - GM, Daihatsu, Toyota
- 68/14 - Mazda, Ford Escort, Subaru
- 73/14 - Toyota, Lexus
- 76/14 - VW, Porsche, Mercedes, BMW, Audi A3, Opel
- 80/15 - Nissan, Honda, Mazda, Isuzu, Subaru, Opel, Toyota
- 93/15 - Opel, Mazda, Volvo, Mitsubishi, Nissan, VW, Porsche, Renault, Ford, Honda, Audi
- 93/36 - Ford
- 65/67 - Daihatsu
- 80/82 - Mazda, Subaru, Toyota, Honda Acura, Nissan
- 90/15 - Honda Accord, Mitsubishi, Isuzu
- 75/77 - VW, Audi, Ford, Isuzu, Mercedes, Opel
- 76/30 - Ford
- 100/15 - Isuzu, Mitsubishi
- 74/76/15 - VW, Porsche, Mercedes, BMW, Audi A3, Opel

mm	mm	mm
HT8G306	1	5

**DE** Ölfilterschlüssel 14 Stk **EN** Oil filter wrenches **FR** Clés à filtre à huile 14 pièces **ES** Llaves para filtros de aceite 14 piezas **HR** Ključevi za filtere za ulje 14 kom **HU** Olajszűrő kulcsok 14 db **RO** Chei filtru ulei 14 buc **BG** Ключове за маслен филтър



×30 60x120 mm 3/8" 1/2" STEEL

- 3 arms: 65 - 120 mm
- Adapter 10 mm (3/8") x 12,5 mm (1/2")
- 65/14 - Daihatsu, Toyota, Nissan, Fiat
- 65/67/14 Daihatsu, Toyota
- 66/6 Fiat Punto 1.2, Renault
- 68/14 Mazda, Ford Escort, Subaru
- 73/14 - Toyota, Lexus
- 74/15 - Audi, GM, Rover, Chrysler
- 74/76/15 - Ford, Opel, VW, Audi, Mercedes
- 75/77/15 VW, Audi, Ford, Isuzu, Mercedes, Opel
- 76/8 Fiat Marea, Lancia Delta
- 76/12 Fiat, Renault, Mercedes
- 76/30 - Ford, Motorcraft FL400A
- 78/15 - Nissan, Ford, Toyota
- 80/15 - Nissan, Honda, Opel, Mazda
- 80/82/15 Subaru, Toyota, Honda, Mazda, Nissan
- 86/16 Volvo S40/ S60/ S70/ S80
- 86/18 VW, Audi, Renault, Peugeot, Citroen
- 90/15 - Subaru, Toyota, Honda, Mazda, Nissan
- 92/10 - Fiat, Lancia
- 93/15 - Mazda, Volvo, Mitsubishi, Nissan, Honda
- 93/36 - Ford Motorcraft FLINFLA 1 B, FL3001, FL320
- 93/45 VW, Audi
- 95/5 - Toyota, Alfa, GM, Ford, Chrysler
- 96/18 VW, Renault
- 100/15 - Isuzu, Mitsubishi
- 106/15 - Fiat Ducato 2.5D
- 108/15 - Volvo Diesel C70/ S70/ N70/ 850 TDI
- 108/18 Renault Espace/ Laguna/ Master/ Safrane/ Trafic 2.4 + 2.5 + 2.8D + TDI

mm	mm	mm
HT8G307	1	2

**DE** Zündkerzensteckdose Reparatursatz **EN** Water pump wrench **FR** Kit réparation de filetage de bougies d'allumage **ES** Kit de reparación de roscas de bujía **HR** Ključ vodene pumpe VAG **HU** VAG vízszivattyú kulcs **RO** Chei pentru pompa de apa VAG **BG** Ключ за водна помпа



32,5 mm VAG LENGTH 245 mm

mm	mm	mm	mm
HT8G328	245 mm / 32,5 mm	6	36

**DE** Nockenwellen-Arretierung **EN** Camshaft lock **FR** Blocages du mécanisme de distribution **ES** Bloqueo de sistema de distribución **HR** Blokada bregastog vratila **HU** VAG vezérműtengely zár **RO** Blocare arborele cu came **BG** Инструмент за блокиране на разпределителен вал



VAG LENGTH 48 mm

- VAG motors: 16 V - 1,4, 1,6: FSI - 1,4, 1,6;
- VW - Lupo, Polo, Caddy, Beetle, Golf, Bora (97-10);
- Audi - A2 (00-06);
- Skoda - Fabia, Fabia II, Octavia, Octavia II, Roomster (99-09)

mm	mm	mm
HT8G360	10	40

**DE** Zündkerzensteckdose Reparatursatz **EN** Water pump wrench **FR** Kit réparation de filetage de bougies d'allumage **ES** Kit de reparación de roscas de bujía **HR** Ključ vodene pumpe VAG **HU** VAG vízszivattyú kulcs **RO** Chei pentru pompa de apa VAG **BG** Ключ за водна помпа



30,5 mm VAG LENGTH 295 mm

mm	mm	mm	mm
HT8G329	295 mm / 30,5 mm	6	36

**DE** Nockenwellen-Arretierung **EN** Camshaft lock **FR** Blocages du mécanisme de distribution **ES** Bloqueo de sistema de distribución **HR** Blokada bregastog vratila **HU** VAG vezérműtengely zár **RO** Blocare arborele cu came **BG** Инструмент за блокиране на разпределителен вал

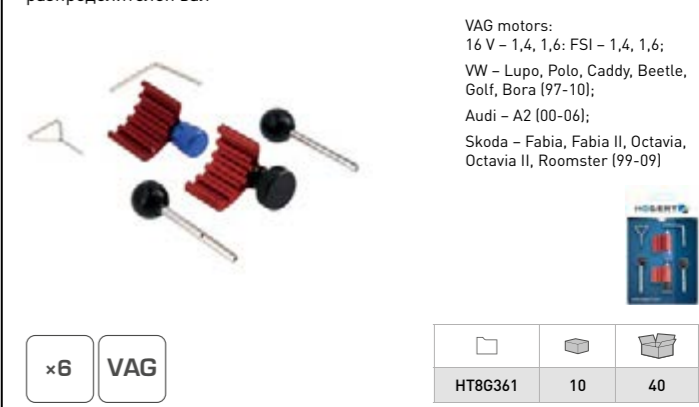

×6 VAG

- VAG motors: 16 V - 1,4, 1,6: FSI - 1,4, 1,6;
- VW - Lupo, Polo, Caddy, Beetle, Golf, Bora (97-10);
- Audi - A2 (00-06);
- Skoda - Fabia, Fabia II, Octavia, Octavia II, Roomster (99-09)

mm	mm	mm
HT8G361	10	40

**DE** Nockenwellen-Arretierungen **EN** Camshaft lock **FR** Blocages du mécanisme de distribution **ES** Bloqueos de sistemas de distribución **HR** Blokade bregastog vratila **HU** VAG vezérműtengely zár **RO** Blocare arborele cu came **BG** Инструмент за блокиране на разпределителен вал



×8 NYLON STEEL

- Opel
- Rover
- VW
- Citroen
- Ford
- Fiat
- Peugeot
- Isuzu

mm	mm	mm
HT8G362	1	10

**DE** Universalabzieher für Zahnscheiben **EN** Universal puller for timing pulleys **FR** Extracteur de poulie de la distribution universel **ES** Extractor universal para rueda árbol de levas **HR** Univerzalni izvlačač kotura za pojas **HU** Univerzális vezérműtengely tehető **RO** Extractor universal folie de distribuție **BG** Скоба за демонтаж на шайби и ролки



60-90 mm 16mm 24mm CrV

mm	mm	mm
HT8G364	1	10

**DE** Universale Nockenwellenrad-Arretierung **EN** Universal twin cam locking tool **FR** Blocage universel des rouleaux de la distribution **ES** Bloqueo de árboles de levas universal **HR** Univerzalno zaključavanje bregastog vratila **HU** Univerzális ikerkamrás reteszelő **RO** Instrument universal de blocare a camelor duble **BG** Универсален инструмент за блокиране на разпределителен вал



10-180 mm DIESEL PETROL

mm	mm	mm
HT8G363	5	20

**DE** Werkzeugsatz für Lichtmaschinen mit Kupplung **EN** Alternator set with clutch **FR** Set pour alternateurs à embrayage **ES** Juego para alternadores con embrague **HR** Komplet za alternatore s kvacičom **HU** Kuplung generátor készlet **RO** Set alternatoare ambreiaj **BG** Комплект за ремонт на алтернатори

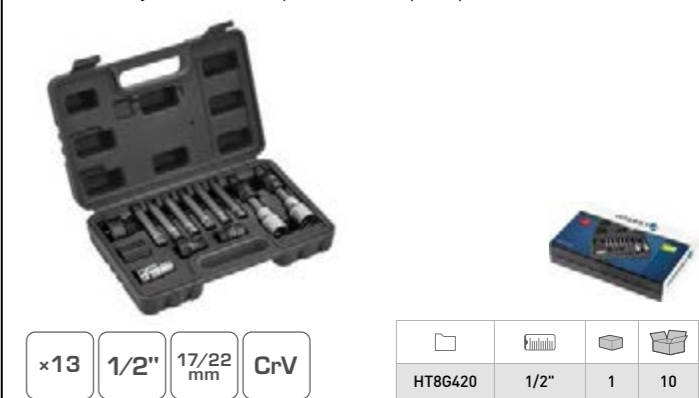

×13 1/2" 17/22 mm CrV

mm	mm	mm
HT8G420	1/2"	1 10

**DE** Vorrichtung zur Demontage von Motorventilen **EN** Overhead valve spring compressor **FR** Un extracteur pour démonter les soupapes du moteur **ES** Un extractor para desmontar válvulas de motor **HR** Izvlakač za rastavljanje ventila motora **HU** Húzó a motorszelepek szétszereléséhez **RO** Un trăgător pentru dezasambla supape motor **BG** Комплект със скоба за клапани



engines OHV, OHC, CHV	for VALVES				
HT8G252	115 mm	1	20		

**DE** Injektionsprüfgerät **EN** Injector tester **FR** Testeur d'injection **ES** Probador de inyección **HR** Ispitivač ubrizgavanja **HU** Injekciós tesztelő **RO** Tester de injecție **BG** Тестер за инжектиране



12 V	PETROL				
HT8G432	1	24			

**DE** Reinigungssatz für Einspritzdüsen **EN** Universal injector seat cleaning set **FR** Kit de nettoyage de douille d'injecteur **ES** Kit de limpieza de casquillos de inyector **HR** Komplet za čišćenje utičnice mlaznice **HU** Befecskendő aljzat tisztító készlet **RO** Set curățare priză injector **BG** Комплект фрези за почистване леглата на дизелови инжектори



x14	3 x steel	2 x silicon			
HT8G327	1	5			

**DE** Fühlerlehre **EN** Feeler gauge **FR** Jauge d'épaisseur **ES** Medidor de espesores **HR** Mjerač zazor ventila **HU** Hézagoló **RO** Manometru **BG** Луфтомер

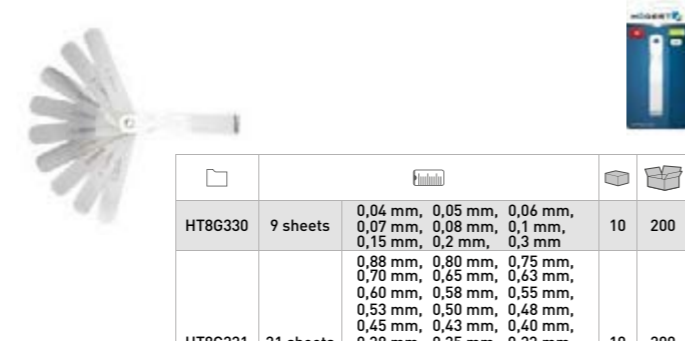

75 mm	13 mm				
HT8G330	9 sheets	0,04 mm, 0,05 mm, 0,06 mm, 0,07 mm, 0,08 mm, 0,1 mm, 0,15 mm, 0,2 mm, 0,3 mm	10	200	
HT8G331	31 sheets	0,88 mm, 0,80 mm, 0,75 mm, 0,70 mm, 0,65 mm, 0,63 mm, 0,60 mm, 0,58 mm, 0,55 mm, 0,53 mm, 0,50 mm, 0,48 mm, 0,45 mm, 0,43 mm, 0,40 mm, 0,38 mm, 0,35 mm, 0,33 mm, 0,30 mm, 0,28 mm, 2 x 0,25 mm, 0,23 mm, 0,20 mm, 0,18 mm, 0,15 mm, 0,12 mm, 0,10 mm, 0,08 mm, 0,06 mm, 0,005 mm, 0,004 mm	10	200	

**DE** Ringpresse **EN** Piston ring compressor **FR** Compresseur de segments de piston **ES** Abrazadera de anillos **HR** Crimper za prstenove **HU** Csavaros rögzítőbilincs **RO** Compresor inel piston **BG** Скоба за монтаж на бутала



SK5					
HT8G423	50-125	75 mm	1	50	
HT8G424	90-175	100 mm	1	50	
HT8G425	90-175	150 mm	1	50	

**DE** Glühkerzenschlüssel **EN** Spark plug wrenches **FR** Clés à bougies **ES** Juego de llaves para bujías **HR** Ključevi za svjećice žarnice **HU** Izzítógyertya kulcsok **RO** Chei tubulare pentru bujii **BG** Комплект вложки за автомобилни подгръващи свещи



x6	3/8"	160mm	17mm	CrV	
HT8G320	8, 9, 10, 12, 14, 16 mm	1	5		

**DE** Glühkerzentester **EN** Glow plug analyser **FR** Testeur de bougie de préchauffage **ES** Probador de bujías incandescentes **HR** Ispitivač žarnice **HU** Izzítógyertya-tesztelő **RO** Tester bujie incandescenta **BG** Тестер на подгръвните свещи



12 V	DIESEL				
HT8G430	1	50			

**DE** Zündfunkenprüfgerät **EN** Spark indicztor **FR** Testeur d'étincelles d'allumage **ES** Probador de chispa de encendido **HR** Ispitivač svjećica za paljenje **HU** Gyújtási szikra tesztelő **RO** Tester cu scântei de aprindere **BG** Тестер за запалителната система



12 V	for SPARK				
HT8G431	50	500			

**DE** Kompressionstester für Dieselmotore **EN** Compression pressure gauge for diesel engines **FR** Appareil de mesure de pression pour moteurs Diesel **ES** Madidor de presión de compresión en motores diésel **HR** Manometar kompresije tlaka za dizelske motore **HU** Kompressziós nyomásmérő dízelmotorokhoz **RO** Manometru de compresie pentru motoare diesel **BG** Комплект за измерване на компресия на дизелови двигатели

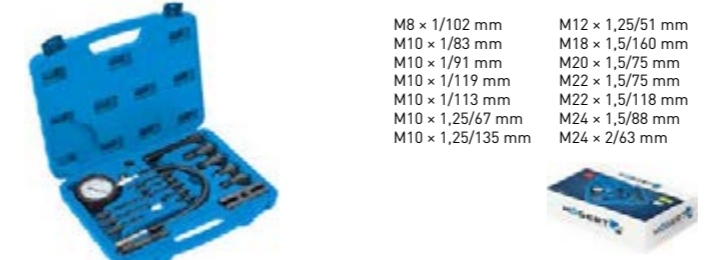

x16	70 BAR	1015 PSI	FOR DIESEL		
HT8G410	1	5			

- M8 x 1/102 mm
- M10 x 1/83 mm
- M10 x 1/91 mm
- M10 x 1/119 mm
- M10 x 1/113 mm
- M10 x 1,25/67 mm
- M10 x 1,25/135 mm
- M12 x 1,25/51 mm
- M18 x 1,5/160 mm
- M20 x 1,5/75 mm
- M22 x 1,5/75 mm
- M22 x 1,5/118 mm
- M24 x 1,5/88 mm
- M24 x 2/63 mm

- 300 mm
- 150 mm

**DE** Kompressionsmanometer **EN** Compression pressure gauge **FR** Compressiomètre à manomètre **ES** Medidor de presión de compresión **HR** Tester kompresije za benzinske motore **HU** Kompressziós nyomásmérő **RO** Manometru de compresie **BG** Комплект за измерване на компресия на дизелови двигатели бензинови двигатели



x8	300 PSI	20 BAR	490mm	150mm	150mm
HT8G412	1	1			

- M10 x 1.00, M12 x 1.25
- M14 x 1.25, M18 x 1.50

**DE** Kompressionstester für Benzinmotore **EN** Compression pressure gauge **FR** Appareil de mesure de pression de la compression **ES** Medidor de presión de compresión **HR** Manometar tlaka kompresije **HU** Kompressziós nyomásmérő **RO** Manometru de compresie **BG** Комплект за измерване на компресия



x3	20 BAR	300 PSI	PETROL		
HT8G411	1	20			

**DE** Zylinderlecktester **EN** Cylinder leak tester **FR** Testeur de fuites de cylindres **ES** Tester de estanqueidad de cilindros **HR** Ispitivač curenja cilindra **HU** Hengerfejt diagnosztika készlet **RO** Tester de etanșare a cilindrului **BG** Тестер за цилиндри



7 BAR	100 PSI	480mm	M12	PETROL	
HT8G413	1	5			

**DE** Öldruckprüfer **EN** Oil pressure tester **FR** Testeur de pression d'huile **ES** Tester de presión de aceite **HR** Ispitivač tlaka ulja **HU** Olajnyomás diagnosztikai készlet **RO** Tester de presiune a uleiului **BG** Тестер за налягане на горивото



x12	10 BAR	140 PSI	1,2m	PETROL	DIESEL
HT8G414	1	10			

- M10 x 1.0
- M12 x 1.5
- M14 x 1.5
- M16 x 1.5
- M18 x 1.5
- 1/8" x 27 NPT
- 1/4" x 20 UNF
- 3/8" x 20 UNF
- 1/2" x 20 UNF
- R1/8"

**DE** Kraftstoffespritzdruckprüfgerät **EN** Fuel injection pressure tester **FR** Testeur l'injection de carburant sous pression **ES** Tester de presión de combustible de inyector **HR** Komplet ispitivača za tlak goriva **HU** Üzemanyag nyomásmérő befecskendezéssel **RO** Tester de presiune a combustibilului cu injecție **BG** Тестер на горивният инжекцион



10 BAR	140 PSI	PETROL	K-KE-JETRONIC SIS	KE-JETRONIC KIC	L-JETRONIC LW
HT8G415	1	5			

**DE** Kraftstoffespritzdruckprüfgerät **EN** Fuel injection pressure tester set **FR** Testeur l'injection de carburant sous pression **ES** Tester de presión de combustible de inyector **HR** Komplet ispitivača za tlak goriva **HU** Üzemanyag nyomásmérő befecskendezéssel **RO** Tester de presiune a combustibilului cu injecție **BG** Тестер на горивният инжекцион



x10	7 BAR	100 PSI			
HT8G416	1	10			

**DE** Prüfgerät für common Rail Rücklaufmengen **EN** Diagnostic kit for common rail injectors **FR** Kit de diagnostic pour injecteurs Common Rail **ES** Kit de diagnóstico para inyectoros common rail **HR** Dijagnostički komplet za ubrizgače Common Rail **HU** Diagnosztikai készlet common rail injektorokhoz **RO** Set de diagnostic pentru injectoare common rail **BG** Комплект за тестване на дъзи Common rail



x31	DIESEL	6 CYLINDER	DELPHI	BOSCH	SIEMENS	DENSO
HT8G418	1	5				



**DE** Drehwinkelmesser **EN** Torque angle gauge **FR** Rapporteur pour resserrer les boulons **ES** Transportador para apretar tornillos **HR** Kutomjer za zatezanje vijaka **HU** Nyomaték szögmérő **RO** Unghiul de cuplu **BG** Ъгломер за притягане



1/2" 360° +/- 20 CrV

HT8G421	1/2"	12	48
---------	------	----	----

**DE** Schraubenausdreher-Satz **EN** Extractors for bolts with broken drill bits **FR** Extracteurs des boulons cassés avec mèches **ES** Machos de izquierdas para tornillos partidos con brocas **HR** Odvijajući za vadenje polomljenih vijaka s svrdlama **HU** Csavar kiemelők fúró-bitfejekkel a törött csavarokhoz **RO** Extractoare cu surub cu burghie pentru suruburi rupte **BG** Комплект за възстановяване на резби



2, 3, 4, 5, 7, 10 mm

M3-M6, M6-M8, M8-M10, M11-M14, M14-M18, M18-M24

x12 M3-M24 HSS

HT8G400	M3-M24	1	36
---------	--------	---	----

**DE** Schraubenausdreher **EN** Twist socket set **FR** Extracteurs des boulons 10-19 mm, 3/8", CrMo, 10 pcs **ES** Extractores para tornillos **HR** Ekstraktori za vadenje vijaka **HU** Csavar kiemelő készlet **RO** Set de extractoare de suruburi **BG** Экстрактори за гайки



10, 11, 12, 13, 14, 15, 16, 17, 19 mm



x10 3/8" HRC 52-55 CrMo

HT8G401	1	20
---------	---	----

**DE** Stehbolzen-Ausdreher Satz **EN** Bolt extractors set **FR** Extracteurs des goujons **ES** Extractores para pernos **HR** Ekstraktori za vadenje pinova **HU** Csavar kiemelő készlet **RO** Set de chei pentru extragere prin rasucire **BG** Комплект за изваждане на скъсани болтове



2, 3, 4, 6, 8, 10 mm.



x6 3/8" HRC 49-52 CrMo

HT8G402	1	20
---------	---	----

**DE** Stehbolzen-Ausdreher Satz 8-16 mm, 1/2", 5 tlg. **EN** Bolt extractors set **FR** Extracteurs des goujons **ES** Extractores para pernos **HR** Ekstraktori za vadenje igla **HU** Csavar kiemelő készlet **RO** Set de chei pentru extragere prin rasucire **BG** Комплект за изваждане на скъсани болтове



8, 10, 12, 14, 16 mm.



x5 1/2" HRC 49-52 CrMo

HT8G403	1	20
---------	---	----

**DE** Schraubenausdreher **EN** Screw nuts **FR** Extracteurs des boulons **ES** Machos de izquierdas para tornillos **6 uds.** **HR** Ekstraktori za vadenje vijaka **HU** Csavar kiemelő készlet **RO** Extractoare de surub **BG** Комплект за възстановяване на резби



M3-M6, M6-M8, M8-M11, M11-M14, M14-M18, M18-M25



x6 M3-M24

HT8G404	12	48
---------	----	----

**DE** Zündkerzensteckdose Reparatursatz **EN** Spark plug socket repair kit **FR** Kit réparation de filetage de bougies d'allumage **ES** Kit de reparación de roscas de bujía **HR** Komplet za popravak navoja svjećice **HU** Gyújtógyertyya menetjavító készlet **RO** Kit de reparație a prizei bujiei **BG** Комплект за ремонт на резби на запалителни свещи



M10-M18 M10 x1.0 M12 x1.25 M14 x1.5 M18 x1.5 HRC 50 STEEL

HT8G405	8	96
---------	---	----

**DE** Reparatursatz für Lambdasondenbuchse **EN** Lambda probe socket repair kit **FR** Kit réparation de filetage de sonde lambda **ES** Kit de reparación de roscas de sondas lambda **HR** Komplet za popravak osjetnika Lambda **HU** Lambda szonda menetjavító készlet **RO** Kit reparație prize sondă Lambda **BG** Комплект за ремонт на резби сонда Lambda



M12-M18 M12 x1.25 M18 x1.5 HRC 50 STEEL

HT8G406	8	96
---------	---	----

**DE** Muttersplitter **EN** Nut splitter set **FR** Casse-écrou **ES** Cortatuercas **HR** Cjepač matica **HU** Anyavágó készlet **RO** Trusa demontare suruburi **BG** Экстрактори за гайки



NEW



#1 9-12 mm HEX 12 mm #2 12-16 mm HEX 14 mm #3 16-22 mm HEX 19 mm #4 22-27 mm HEX 21 mm #45 CrV 40-45 HRC HEX 21 mm

HT8G407	5	10
---------	---	----

**DE** Muttersplitter **EN** Nut splitter **FR** Casse-écrou **ES** Cortatuercas **HR** Cjepač matica **HU** Anyavágó **RO** Demontare suruburi **BG** Экстрактори за гайки



NEW



#3 16-22 mm HEX 19 mm #45 CrV 40-45 HRC

HT8G409	20	40
---------	----	----

**DE** Muttersplitter **EN** Nut splitter **FR** Casse-écrou **ES** Cortatuercas **HR** Cjepač matica **HU** Anyavágó **RO** Demontare suruburi **BG** Экстрактори за гайки



NEW



#2 12-16 mm HEX 14 mm #45 CrV 40-45 HRC

HT8G408	40	80
---------	----	----

**DE** Abstreifer **EN** Scraper set **FR** Jeu de grattoirs **ES** Juego de raspadores **HR** Set strugala **HU** Kaparó készlet **RO** Set de racletă **BG** Комплект инструменти за демонтаж на авто панели



x5 STEEL PP scrapers 260 mm 225 mm hooks 220 mm 165 mm needle 210 mm

HT8G394	6	36
---------	---	----

**DE** Klemme für Polsterstifte **EN** Clamp for upholstery pins **FR** Arrache-agraves **ES** Extractor para clips de fijación de tapicería **HR** Uklanjač spojnice za tapaciranje **HU** Kárpit patent kisedő **RO** Extractor capse tapiterie **BG** Комплект инструменти за демонтаж на авто панели

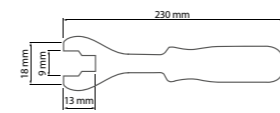
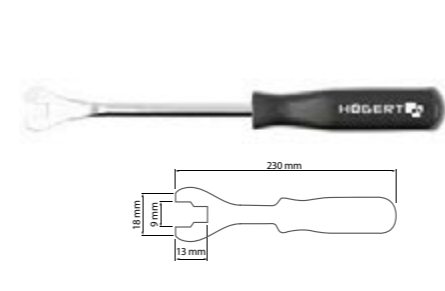

LENGTH 230 mm

HT8G393	16	64
---------	----	----

**DE** Panel-Entfernungs-Set **EN** Panel removal set **FR** Outils de démontage de la garniture **ES** Extractores para tapicería **HR** Skideri za presvlake **HU** Kárpit eltávolító készlet **RO** Set pentru eliminarea panoului **BG** Комплект инструменти за демонтаж на авто панели

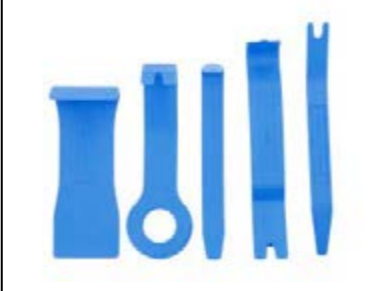

x5 NYLON

HT8G390	5	20
---------	---	----

**DE** Panel-Entfernungs-Set **EN** Panel removal set **FR** Outils de démontage de la garniture **ES** Extractores para tapicería **HR** Skideri za presvlake **HU** Kárpit eltávolító készlet **RO** Set pentru eliminarea panoului **BG** Комплект инструменти за демонтаж на авто панели



x6 NYLON

HT8G391	6	24
---------	---	----

**DE** Meißel-Schaber **EN** Panel removal set **FR** Grattoirs **ES** Cinceles rasquetas **HR** Dlijeta strugači **HU** Véső lehúzó készlet **RO** Set de raziure de dalta **BG** Комплект пластмасови длета за демонтаж



x4 NYLON 19/22/25/38 mm

HT8G392	265 mm	6	24
---------	--------	---	----

**DE** Dichtungsabzieher **EN** Seal puller **FR** Extracteur des joints **ES** Extractor de juntas  
**HR** Izvlakač za brtve **HU** Tömítőhúzó **RO** Extractor sigiliu **BG** Инструмент за вадене на семеринги и уплътнения



LENGTH  
295 mm

ERGO

HT8G422	295 mm	9	36

**DE** Blechschmiedeset **EN** A tinsmith set **FR** Ensemble **ES** Conjunto para chapista  
**HR** Limarski set **HU** Bádógos készlet **RO** Set siguranțe auto **BG** Комплект тенекеджийски чукове и наковални



x7 x1 x1 x1 x4

DROP FORGED

HT8G460	1	4

**DE** Kabelklemmen **EN** Cable clamps **FR** Pincés d'obturation pour tuyaux et raccords banjos **ES** Abrazaderas para cables **HR** Set krokodil stezaljki **HU** Csőszorító készlet **RO** Bride de cablu **BG** Комплект херметични електрически конектори



x8

RING x2 8mm x2 10mm x2 13mm x2

NYLON

HT8G428	8 - 13 mm	1	10

**DE** Stahlklemmzange **EN** Boot clamp pliers **FR** Pince pour colliers en acier **ES** Alicata para abrazaderas de acero **HR** Klijesta za čelične sigurnosne prstene **HU** Acél bilincsfogó **RO** Cleste de prindere din oțel **BG** Клещи за скоби за водни съединения



1/2" LENGTH 245 mm CrV

HT8G340	6	36

**DE** Farbdickenmessgerät **EN** Paint thickness tester **FR** Mesureur d'épaisseur de peinture **ES** Medidor de espesor de pintura **HR** Mjerač debljine laka na vozilu **HU** Festékbevonat vastagságmérő **RO** Calibru grosime acoperire vopsea **BG** Тестер на грапавостта на повърхности



mm/mil 0-2 mm 0-80 mil +/- 2% CR 2032 3V

HT8G427	1	80

**DE** Abklemmzangen **EN** Flexible line clamp **FR** Pincés de serrage tuyaux **ES** Pinzas prensa para mangueras **HR** Stezaljke crijeva **HU** Rögzítő fogó **RO** Clema flexibila de linie **BG** Комплект щипки за блокиране на гъвкави проводници



Ø 6,3-19 mm (1/4"-3/4")  
Ø 12,5-32 mm (1/2"-5/4")  
Ø 19-57 mm (3/4"-9/4")



x3 NYLON

HT8G426	1	50

**DE** Klemmen für Metallkabel **EN** Fluid lock set **FR** Pincés pour câbles métalliques **ES** Abrazaderas para cables metálicos **HR** Svorky pro kovové kabely **HU** Bilincsek fém kábelekhöz **RO** Cleme pentru cabluri metalice **BG** Комплект щипки за блокиране на метални кабели



x3 AI 4.2-10 mm

HT8G436	12	48

**DE** Benzinleitungs-Zange **EN** Fuel feed pipe pliers **FR** Pince pour conduits de carburant **ES** Alicata para líneas de combustible **HR** Klijesta za cijevi goriva **HU** Üzemanyag-adagoló cső fogó **RO** Cleste pentru conducte de alimentare cu combustibil **BG** Клещи за демонтаж на маручки на горивната система



AI LENGTH 205 mm

HT8G341	10	30



**DE** Leitungszange Arbeitsbereich **EN** Hose removing pliers, operating range **FR** Pince pour démonter des conduits **ES** Pinza sacacables **HR** Klješta za uklanjanje crijeva **HU** Tömlő eltávolító fogó **RO** Cleste pentru indepartarea furtunului **BG** Клещи за демонтаж на маркучи



Ø 5-15 mm	5-30 mm	LENGTH 200 mm	STEEL	HT8G342	10	50
-----------	---------	---------------	-------	---------	----	----

**DE** Zündkabelzange **EN** Ignition cable pliers **FR** Pince pour conduits d'allumage **ES** Alicates para cables de arranque **HR** Klješta za kablove za paljenje **HU** Gyújtóhuzal fogó **RO** Cleste de sarma de aprindere **BG** Клещи за кабели на свещи



LENGTH 255 mm	STEEL	HT8G343	10	40
---------------	-------	---------	----	----

**DE** Federbandschellen-Zange, gerade **EN** Pliers for ties and clamps, straight **FR** Pince pour colliers et serrages, droite **ES** Alicates para cables de arranque, rectos **HR** Klješta za sigurnosne prstene i stezaljke za proširenje, ravna **HU** Egyenes bilincsfogó **RO** Cleste de prindere drepte **BG** Клещи за скоби за водни съединения, прав шлиц



Ø 12 mm	LENGTH 230 mm	4 mm STOP	HT8G344	6	30
---------	---------------	-----------	---------	---	----

**DE** Federbandschellen-Zange, gebogen **EN** Pliers for ties and clamps, bent **FR** Pince pour colliers et serrages, courbée **ES** Alicates para cables de arranque, rectos, 45°, 215 mm **HR** Klješta za sigurnosne prstene i stezaljke za proširenje, zakrivljena **HU** Hajlított bilincsfogó **RO** Cleste cu cleme indoite **BG** Клещи за скоби за водни съединения, извити с прав шлиц



Ø 12 mm	215 mm	4 mm STOP	HT8G345	6	30
---------	--------	-----------	---------	---	----

**DE** Federbandschellen-Zange, flexibel **EN** Pliers with a tie cable **FR** Pince avec câble pour colliers **ES** Alicates con cable para abrazaderas **HR** Klješta za crijevne obujmice sa lancem **HU** Tömlőbilincsfogó **RO** Cleste pentru cablu de prindere a furtunului **BG** Клещи за водни съединения, гъвкаво жило



18-54 mm	210-690 mm	4 mm STOP	CrMo	HT8G346	15	30
----------	------------	-----------	------	---------	----	----

**DE** Schlauchklemmzange für CLIC und CLIC-R Klemmen **EN** Hose clip pliers CLIC and CLIC-R **FR** Pince pour collier du type CLIC et CLIC-R **ES** Alicates para abrazaderas tipo CLIC y CLIC-R **HR** Klješta za sigurnosne prestene CLIC i CLIC-R **HU** Tömlőbilincsfogó (CLIC és CLIC-R) **RO** Cleste cu cleme pentru furtun (CLIC si CLIC-R) **BG** Клещи за скоби тип "Click" и "Click R"



CLIC-R	CLIC	LENGTH 175 mm	HT8G347	10	50
--------	------	---------------	---------	----	----

**DE** CV-Gelenkklammenschettenzange **EN** CV joint clamp boot pliers **FR** Pince botte de serrage joint **ES** Alicates de bota de abrazadera de junta homocinética **HR** Klešta za stezaljke sa CV spojnicom **HU** Fogó rögzítő acél kapcsolatok **RO** Cleste pentru montarea legăturilor din oțel **BG** Инструмент за водни съединения



10x1 mm	HT8G349	10	30
---------	---------	----	----

**DE** Refraktometer **EN** Refractometer **FR** Réfractomètre **ES** Refractómetro **HR** Refraktometar **HU** Refraktométer **RO** Refractometru **BG** Професионален рефрактометър



-10°C +50°C	HT8G419	1	25
-------------	---------	---	----

**DE** Digitales Batterieprüfgerät **EN** Digital battery tester **FR** Testeur de batterie numérique **ES** Comprobador de batería digital **HR** Digitalni ispitivač baterija **HU** Digitális akkumulátor tesztelő **RO** Tester digital de baterii **BG** тестер за акумулатори



12 V	100 A	LED LIGHT	HT8G620	1	10
------	-------	-----------	---------	---	----

**DE** Anlasserkabe **EN** Jumper cables **FR** Câbles de démarrage **ES** Cables de arranque **HR** Kabel za pokretanje **HU** Indító kábel **RO** Cablu de pornire **BG** Кабели за стартов ток



Cu/Al	m	A	cm <sup>2</sup>	HT8G601	3	400	1400	1	20
				HT8G602	3,5	600	2000	1	20

**DE** Elektronisches Ladegerät **EN** Automatic battery charger **FR** Cargador de batería automática **ES** Chargeur de batterie automatique **HR** Automatski punjač akumulatora **HU** Akkumulátor töltő **RO** Incarcator electric **BG** Зарядно за акумулатор



max 7A	max 6V/12V	max 105 Ah	Standard	HT8G611	max 7 A	1	4
230V ~50Hz	4A/7A	2 m					

**DE** Elektronisches Ladegerät **EN** Automatic battery charger **FR** Cargador de batería automática **ES** Chargeur de batterie automatique **HR** Automatski punjač akumulatora **HU** Akkumulátor töltő **RO** Incarcator electric **BG** Зарядно за акумулатор



MAX 6V/12V	MAX 12A	WET	AUTO	20-200 Ah	IP 20	HT8G614	1	5
------------	---------	-----	------	-----------	-------	---------	---	---

**DE** Auto Strommesser **EN** Car current tester **FR** Courantomètre automobile **ES** Medidor de corriente para automóviles **HR** Brojilo struje automobila **HU** Autó árammérő **RO** Contor de curent auto **BG** Автомобилен токомер



12 V	MTA	HT8G435	1	60
------	-----	---------	---	----

**DE** Elektronisches Ladegerät **EN** Automatic battery charger **FR** Cargador de batería automática **ES** Chargeur de batterie automatique **HR** Automatski punjač akumulatora **HU** Akkumulátor töltő **RO** Incarcator electric **BG** Зарядно за акумулатор



230V ~50Hz	max 6V/12V	max 140Ah	STANDARD GEL/AGM	HT8G610	2 A / 4 A	1	20
------------	------------	-----------	------------------	---------	-----------	---	----

**DE** Elektronisches Ladegerät **EN** Automatic battery charger **FR** Cargador de batería automática **ES** Chargeur de batterie automatique **HR** Automatski punjač akumulatora **HU** Akkumulátor töltő **RO** Incarcator electric **BG** Зарядно за акумулатор



12 V	2A/8A/15A	WET/ GEL/ AGM/ Ca-Ca	AUTO	HT8G613	1	8
15-300 Ah	9 STEPS	Desulfator/Conditioner	IP 20			

**DE** Elektronisches Ladegerät **EN** Automatic battery charger **FR** Cargador de batería automática **ES** Chargeur de batterie automatique **HR** Automatski punjač akumulatora **HU** Akkumulátor töltő **RO** Incarcator electric **BG** Зарядно за акумулатор



MAX 12V/24V	14A/26A	WET	AUTO	HT8G616	1	2
40-350 Ah	IP 20	BOOSTER				



DE Fettpresse EN Grease gun FR Pistolet à graisse à poignée pistolet ES Pistola de engrasar HR Mast pištolj HU Zsírzóprés RO Pistol de unsoare BG Ръчен такаламит





400 ml	4500-6000 PSI 310-415 BAR	400 g	1,2 cm <sup>3</sup>	x4	
HT8G904	1	10			

DE Fettpresse EN Grease gun FR Pistolet à graisse à poignée pistolet ES Pistola de engrasar HR Mast pištolj HU Zsírzóprés RO Pistol de unsoare BG Ръчен такаламит



400 cm <sup>3</sup>	400 g	max 8000 psi/ 550 bar	x4	
M10 x1.0	Al	1,2 cm <sup>3</sup>		
HT8G905	1	10		

DE Fettpresse EN Grease gun FR Pistolet à graisse à poignée pistolet ES Pistola de engrasar HR Mast pištolj HU Zsírzóprés RO Pistol de unsoare BG Ръчен такаламит

600 ml	6000-8000 PSI 400-550 BAR	2,4 cm <sup>3</sup>	300mm	x4	
HT8G907	1	10			

DE Fettpresse EN Grease gun FR Pistolet à graisse à poignée pistolet ES Pistola de engrasar HR Mast pištolj HU Zsírzóprés RO Pistol de unsoare BG Ръчен такаламит



600 cm <sup>3</sup>	x2	max 10000 psi/ 700 bar	x4	
M10 x1.0	300mm	150 mm	2,4 cm <sup>3</sup>	
HT8G908	1	10		

DE Fettpresse EN Grease gun FR Pistolet à graisse à poignée pistolet ES Pistola de engrasar HR Mast pištolj HU Zsírzóprés RO Pistol de unsoare BG Ръчен такаламит



6 l	3600 PSI 250 BAR	1.8 m	3 cm <sup>3</sup>	
HT8G912	1	1		

DE Fettpresse EN Grease gun FR Pistolet à graisse à poignée pistolet ES Pistola de engrasar HR Mast pištolj HU Zsírzóprés RO Pistol de unsoare BG Ръчен такаламит



16 l	max 2600 PSI 180 BAR	1.8 m	3 cm <sup>3</sup>	
HT8G913	1	1		

DE Pneumatischer Fettpresse EN Pneumatic grease gun FR Graisseur pneumatique ES Lubricador neumático HR Pneumatska mazalica HU Pneumatikus kenőanyag adagoló RO Pistol de gresat pneumatic BG Ръчен такаламит пневматичен



400 ml	90 PSI/ 6 BAR	113 l/min	1/4"	
HT4R790	1	10		

DE Pneumatischer Fettpresse EN Pneumatic grease gun FR Graisseur pneumatique ES Lubricador neumático HR Pneumatska mazalica HU Pneumatikus kenőanyag adagoló RO Pistol de gresat pneumatic BG Ръчен такаламит пневматичен



12 l	4350-5800 PSI 300-400 BAR	87-116 PSI 6-8 BAR	0.85 l/min	50:1	
HT4R795	1	1			

DE 4 Backen Mundstück für Fettpresse EN Grease coupler FR Coupleur à graisse ES Boquilla para engrasadora de 4 garras HR Vrh s 4 čeljusti HU Zsírozó csatlakozó RO Cuplaj pentru aparat de ungere BG Накрайник 4-челюстен



x4	x2	37 mm	M10 x 1
----	----	-------	---------

HT8G915	37 mm	50	100
---------	-------	----	-----

DE Ölspritzkanne Plastik EN Plastic pressure oil can FR Huile de pression de métal ES Aceitera de plástico HR Podmazivač od plastike HU Műanyag olajozó kanna RO Dispozitiv de ulei din plastic BG Масльонка пластмасова



250 ml	PLASTIC
--------	---------

HT8G925	10	60
---------	----	----

DE Öl Absaugpumpe EN Oil suction gun FR Pistolet d'aspiration d'huile ES Pistola de succión, agujeros de inspección en el cuerpo HR Usisavač HU Szívó fecskendő RO Seringa de aspiratie BG Шприц за масло



500 ml	280mm
--------	-------

HT8G935	1	20
---------	---	----

DE Flüssigkeitsspender EN Vacuum pump FR Distributeur de liquide ES Dispensador de líquido HR Dozator za tekućinu HU Folyadékadagoló RO Dozator lichid BG Туба за индустриални течности



350 ml	OIL	DIESEL	WATER	ADBLUE
--------	-----	--------	-------	--------

HT8G937	1	10
---------	---	----

DE Schlauch für Fettpresse EN Grease gun hose FR Tuyau de pistolet à graisse ES Manguera para engrasadora HR Crijevo za podmazivač HU Zsírozó pisztoly tömlő RO Furtun pentru aparat de ungere BG Маркуч за шприц за масло



M10 x 1	max 10150 PSI 700 BAR	8 mm	LENGTH 300 mm
---------	-----------------------	------	---------------

HT8G920	8 x 300 mm	10	100
---------	------------	----	-----

DE Ölspritzkanne Metall EN Metal pressure oil can FR Huile de pression de métal ES Aceitera de metal HR Metalni podmazivač HU Fém olajozó kanna RO Dispozitiv de ulei din metal BG Масльонка метална



200 ml	METAL
--------	-------

HT8G930	10	60
---------	----	----

DE Öl Absaugpumpe EN Oil suction gun FR Pistolet d'aspiration d'huile ES Pistola de succión HR Usisavač HU Szívó fecskendő RO Seringa de aspiratie BG Шприц за масло



500 ml	280mm
--------	-------

HT8G936	1	20
---------	---	----

DE Handpumpe EN Hand pump for barrel FR Pompe à main ES Bomba de mano HR Ručna pumpa HU Kézi pumpa RO Pompa manuala BG Вложки за картерни пробки



200 ml	Al	16-18 l/min	45-90 cm
0,25 l	BARREL SIZE 50, 60, 200 l	WATER	OILS

HT8G940	1	10
---------	---	----

DE Zweiteiliger Trichter EN Two-piece funnel FR Entonnoir carburant avec flexible ES Embudo de dos piezas HR Lijevak od dva dijela HU Kétrészes tölcser RO Pálnie din două piese BG Фуния от две части



145 mm	LENGTH 390 mm
--------	---------------

HT8G945	145 x 390 mm	1	100
---------	--------------	---	-----

DE Ölablass EN Oil drain pan FR Vidange d'huile ES Escurridor de aceite HR Odvod za ulje HU olajleeresztő RO Scurgător de ulei BG Тава за масло



13 cm	10 l	HDPE
-------	------	------

HT8G947	1	50
---------	---	----

DE Schrumpfschläuche-Set 127 Stk. EN Piece heat shrink sleeve set FR Coffret de gaines thermorétractables ES Conjunto de fundas termorretráctiles HR Set termokuplirajućih bužira HU zsugorsó készlet RO manson termocontractabil BG Комплект термосвиваеми ръкави



2.0x40 mm	2.5x40 mm	3.5x40 mm
30 pcs	25 pcs	20 pcs
5.0x40 mm	7.0x80 mm	10.0x80 mm
20 pcs	16 pcs	8 pcs
13.0x85 mm		
8 pcs		

x127	125°C	max 600V
------	-------	----------

HT8G501	105 x 210 mm	5	20
---------	--------------	---	----

DE Set mit Innen- und Außen-Sicherungsringen EN Piece inner and external snap ring set FR Jeu de circlips extérieurs et intérieurs ES Juego de anillos de retención externos e internos HR Set vanjskih i unutarnjih zaustavnih prstena HU belső és külső rögzítőgyűrű készlet RO inele de fixare intern si extern BG Комплект вътрешни блокиращи пръстени/скоби



13 mm	13 mm	14 mm	16 mm	19 mm	20 mm
10 pcs	15 pcs	15 pcs	15 pcs	15 pcs	10 pcs
14 mm	16 mm	19 mm	22 mm	25 mm	32 mm
10 pcs	15 pcs	10 pcs	10 pcs	10 pcs	5 pcs
11 mm	20 mm	11 mm	9 mm	8 mm	6 mm
15 pcs	10 pcs	15 pcs	15 pcs	15 pcs	15 pcs

x225	STEEL 65 Mn	OUTSIDE/INSIDE
------	-------------	----------------

HT8G503	105 x 210 mm	5	20
---------	--------------	---	----

DE Trichter für Betriebsflüssigkeiten EN Long neck funnel FR Entonnoir pour fluides de service ES Embudo para fluidos operativos HR Lijevak za radne tekućine HU Tölcser az üzemfolyadékhoz RO Pálnie pentru fluidele de operare BG Фуния за експлоатационни течности



115 mm	PP	LENGTH 460 mm	1.1 l
--------	----	---------------	-------

HT8G946	1	50
---------	---	----

DE Autosicherungen EN Piece car fuse set FR Fusibles automobile ES Juego de fusibles para automóvil HR Set osigurača za automobile 120 kom. HU autóbiztosíték készlet RO sigurante auto BG Комплект авто предпазители



5 A	10 A	15 A
20 pcs	20 pcs	20 pcs
20 A	25 A	30 A
20 pcs	20 pcs	20 pcs

x120	Zn/Al	Standard
------	-------	----------

HT8G500	105 x 210 mm	5	20
---------	--------------	---	----

DE Außen-Sicherungsringe-Set EN Piece external snap ring set FR Jeu de circlips type extérieur ES Juego de anillos de retención externos HR Set vanjskih zaustavnih prstena HU külső rögzítőgyűrű készlet RO inele de fixare extern BG Комплект външни блокиращи пръстени/скоби



3 mm	6 mm	13 mm	14 mm	16 mm	20 mm
10 pcs	12 pcs	12 pcs	7 pcs	10 pcs	8 pcs
4 mm	8 mm	32 mm	28 mm	27 mm	25 mm
5 pcs	8 pcs	3 pcs	5 pcs	8 pcs	7 pcs
5 mm	10 mm	11 mm	12 mm	19 mm	22 mm
7 pcs	10 pcs	7 pcs	8 pcs	13 pcs	10 pcs

x150	STEEL 65 Mn	OUTSIDE
------	-------------	---------

HT8G502	105 x 210 mm	5	20
---------	--------------	---	----

DE Set mit geraden Splinten EN Piece straight pin set FR Jeu de goupilles fendues ES Juego de pasadores rectos HR Set rascjepki HU egyenes csapszegecs szett RO pini drepti BG Комплект прави щифтове



1.6 x 25 mm	2.4 x 25 mm	2.4 x 38 mm
150 pcs	150 pcs	100 pcs
3.2 x 30 mm	3.2 x 50 mm	4.0 x 64 mm
75 pcs	50 pcs	30 pcs

x555	STEEL
------	-------

HT8G504	105 x 210 mm	5	20
---------	--------------	---	----

DE Nietmuttern-Set EN Piece rivet nut set FR Jeu d'écrous à rivets ES Conjunto de tuercas remachables HR Set zakivnih matica HU szegecsanya készlet RO piulite de nit BG Комплект



M3 x 9 mm 40 tlg/pcs	M4 x 11 mm 35 tlg/pcs	M5 x 13 mm 25 tlg/pcs
M6 x 15 mm 25 tlg/pcs	M8 x 18 mm 15 tlg/pcs	M10 x 21 mm 10 tlg/pcs

x150 STEEL

HT8G505	105 x 210 mm	5	20
---------	--------------	---	----

DE Klappsplint-Set mit Öse EN Piece split pin set FR Jeu de goupilles clips rondes ES Juego de pasadores con orejeta HR Set okruglih osigurača HU osztott csap készlet RO pini divizati BG Комплект кръгли клипсове



3/16" x 1 - 7/16" 16 pcs	1/4" x 1 - 3/4" 18 pcs
5/16" x 1 - 3/4" 6 pcs	7/16" x 1 - 3/4" 10 pcs

x50 STEEL

HT8G506	105 x 210 mm	1	20
---------	--------------	---	----

DE Kupfer-Unterlegscheiben-Set EN Piece copper washer set FR Jeu de rondelles en cuivre ES Juego de arandelas de cobre HR Set bakrenih podloški HU réz alátét készlet RO garnituri de cupru BG Комплект медни шайби



Inner diameter	Outer diameter	Thickness	pcs
6,4 mm	13,6 mm	0,8 mm	30
7,9 mm	15,5 mm	1,5 mm	25
9,5 mm	15,5 mm	1,5 mm	20
11,1 mm	17,4 mm	1,5 mm	15
12,7 mm	18,6 mm	1,5 mm	10
15,9 mm	23,4 mm	1,5 mm	10

x110 CU

HT8G513	105 x 210 mm	5	20
---------	--------------	---	----

DE Feder-Set EN Piece spring set FR Coffret assortiment de ressorts ES Surtido de muelles HR Set opruga HU rugó készlet RO arcuri BG Комплект пружини



Diameter	Length	pcs
4 mm	79,5 mm	12
4,5 mm	44,5 mm	8
5 mm	20,5 mm	10
5,5 mm	25,5 mm	10
6,5 mm	22 mm	10
7 mm	38 mm	10
7 mm	51 mm	12
8 mm	28,5 mm	8
8 mm	44,5 mm	12
8,5 mm	36,5 mm	10
8,5 mm	47 mm	12
5,5 mm	17 mm	10
5,5 mm	38 mm	10
6,5 mm	10 mm	10
7 mm	12,5 mm	10
7 mm	19 mm	10
9 mm	35 mm	8
9,5 mm	16 mm	6
9,5 mm	19 mm	12

x200 STEEL  
124 SIZES  
76 SIZES

HT8G514	105 x 210 mm	5	20
---------	--------------	---	----

DE Gummidichtungen-Set EN Piece rubber gasket set FR Jeu de joints en caoutchouc ES Conjunto de juntas de goma HR Set gumenih brtvi HU gumitömítés készlet RO garnituri de cauciuc BG Комплект гумени уплътнения



Size	Diameter mm	Thickness mm	pcs	Size	Diameter mm	Thickness mm	pcs
R01	3,00	1,50	20	R17	20,00	3,50	10
R02	4,40	2,00	20	R18	22,00	3,50	10
R03	5,00	2,00	18	R19	23,50	3,50	10
R04	7,00	1,50	23	R20	25,00	3,50	10
R05	10,00	1,50	23	R21	25,50	3,50	10
R06	13,00	1,50	23	R22	28,00	3,50	10
R07	10,00	2,50	14	R23	30,00	3,50	10
R08	11,00	2,50	13	R24	31,00	3,50	10
R09	13,00	2,50	14	R25	33,00	3,40	10
R10	14,00	2,50	13	R26	34,50	3,50	10
R11	16,00	2,50	14	R27	35,00	3,50	10
R12	18,00	2,50	14	R28	35,00	3,50	10
R13	19,00	2,50	14	R29	41,00	3,50	10
R14	21,00	2,50	14	R30	44,00	3,50	10
R15	22,00	2,50	13	R31	47,00	3,50	10
R16	18,00	3,50	10	R32	50,00	3,50	10

x418 NBR HEAT RESISTANT -50°C +125°C

HT8G507	3,00-50,00 mm	1	20
---------	---------------	---	----

DE Gummidichtungen-Set EN Piece rubber gasket set FR Jeu de joints en caoutchouc ES Conjunto de juntas de goma HR Set gumenih brtvi HU Gumitömítés készlet RO Garnituri de cauciuc BG Комплект гумени уплътнения



Diameter	Thickness	pcs
5,29 mm	1,78 mm	20
6,07 mm	1,78 mm	20
6,80 mm	1,90 mm	20
7,65 mm	1,78 mm	20
7,80 mm	1,90 mm	20
8,80 mm	2,00 mm	20
8,80 mm	1,90 mm	20
10,82 mm	1,78 mm	15
10,77 mm	2,62 mm	15
11,00 mm	2,00 mm	15
12,00 mm	2,00 mm	15
13,90 mm	1,80 mm	10
13,95 mm	2,62 mm	10
10,00 mm	2,00 mm	10
15,00 mm	2,00 mm	10
17,00 mm	2,00 mm	10
17,70 mm	1,78 mm	10
17,04 mm	3,53 mm	10

x270 NBR HEAT RESISTANT -50°C +125°C

HT8G508	105 x 210 mm	5	20
---------	--------------	---	----

DE Gummidichtungen-Set EN Piece rubber gasket set FR Jeu de joints en caoutchouc ES Conjunto de juntas de goma HR Set gumenih brtvi HU gumitömítés készlet RO garnituri de cauciuc BG Комплект гумени уплътнения



Diameter	Thickness	pcs
3,00 mm	1,00 mm	20
4,00 mm	1,00 mm	20
4,50 mm	2,00 mm	20
5,00 mm	2,00 mm	20
6,00 mm	2,00 mm	20
6,00 mm	2,50 mm	20
6,00 mm	3,00 mm	20
7,00 mm	2,00 mm	20
8,00 mm	2,00 mm	20
9,00 mm	2,00 mm	5
10,00 mm	2,00 mm	5
12,00 mm	3,00 mm	5
13,00 mm	3,00 mm	5
14,00 mm	2,50 mm	5
17,00 mm	2,50 mm	5
18,00 mm	4,00 mm	5
20,00 mm	2,00 mm	5
22,00 mm	2,00 mm	5

x225 NBR HEAT RESISTANT OIL, PETROL, CHEMICAL RESISTANT -50°C +125°C

HT8G509	105 x 210 mm	5	20
---------	--------------	---	----

DE Hydraulikdichtungen-Set EN Piece hydraulic seal set FR Jeu de joints hydrauliques ES Conjunto de juntas hidráulicas HR Set hidrauličnih brtvi HU hidraulikus tömítő készlet RO garnituri hidraulice BG Комплект хидравлични уплътнения

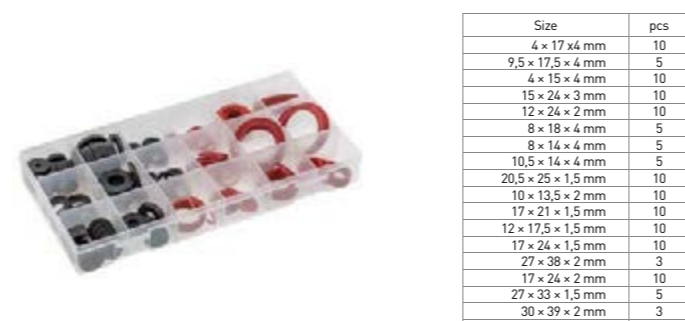

Size	pcs
4 x 17 x 4 mm	10
9,5 x 17,5 x 4 mm	5
4 x 15 x 4 mm	10
15 x 24 x 3 mm	10
12 x 24 x 2 mm	10
8 x 18 x 4 mm	5
8 x 14 x 4 mm	5
10,5 x 14 x 4 mm	5
20,5 x 25 x 1,5 mm	10
10 x 13,5 x 2 mm	10
17 x 21 x 1,5 mm	10
12 x 17,5 x 1,5 mm	10
17 x 24 x 1,5 mm	10
27 x 38 x 2 mm	3
17 x 24 x 2 mm	10
27 x 33 x 1,5 mm	5
30 x 39 x 2 mm	3
12 x 17,5 x 2 mm	10

x141 RUBBER/CARDBOARD

HT8G510	105 x 210 mm	5	20
---------	--------------	---	----

DE Schmiernippel-Set EN Piece grease fitting set FR Jeu de graisseurs ES Surtido de engrasadores HR Set mazalica HU kenőzsírcsavar készlet RO accesorii pentru montare grasime BG Комплект дихтунги



Thread	Type	pcs
M6 x 1		60
M6 x 1	45°	5
M6 x 1	90°	5
M8 x 1		10
M8 x 1	45°	5
M8 x 1	90°	5
M10 x 1		10
M10 x 1	45°	5
M10 x 1	90°	5

x110 STEEL

HT8G511	105 x 210 mm	5	20
---------	--------------	---	----

DE Schlauchschellen-Set EN Piece worm clamps set FR Jeu de colliers à vis sans fin ES Juego de abrazaderas de manguera HR Set obujmica HU csavaros bilincs készlet RO cleme tip vierme BG Комплект скоби за маркучи



Size	pcs
1/2"	5
5/8"	7
3/4"	10
7/8"	4
1"	3
1 1/6"	3
1 3/8"	4
1 1/2"	4

x40 STEEL

HT8G512	105 x 210 mm	5	20
---------	--------------	---	----

DE Befestigungs Clip PEUGOT EN Trim clips assortment PEUGEOT FR Ensemble des clips de garniture PEUGOT ES Conjunto de clips de recorte PEUGOT HR Kopče za automobile PEUGOT HU Rögzítő klipsz készlet PEUGOT RO Set de fixare clip PEUGOT BG Практичен комплект авто клипсове (щипки) за кори PEUGEOT



Clip type	Length	pcs
Uninsulated	50 mm	10
Insulated	50 mm	6
Insulated	70 mm	2
Insulated	75 mm	2
Insulated	35 mm	6
Insulated	45 mm	2

x28

HT8G517	105 x 210 mm	5	20
---------	--------------	---	----

x345 for PEUGOT 12 TYPES

HT8G551	270 x 170 mm	1	25
---------	--------------	---	----

DE Befestigungs Clip FIAT EN Trim clips assortment FIAT FR Ensemble des clips de garniture FIAT ES Conjunto de clips de recorte FIAT HR Kopče za automobile FIAT HU Rögzítő klipsz készlet FIAT RO Set de fixare clip FIAT BG Практичен комплект авто клипсове (щипки) за кори FIAT



x300 for RENAULT 8 TYPES

HT8G550	270 x 170 mm	1	25
---------	--------------	---	----

x308 for FIAT 12 TYPES

HT8G552	270 x 170 mm	1	25
---------	--------------	---	----

**DE** Befestigungs Clip VOLVO **EN** Trim clips assortment VOLVO **FR** Ensemble des clips de garniture VOLVO **ES** Conjunto de clips de recorte VOLVO **HR** Kopče za automobile VOLVO **HU** Rögzítő klipsz készlet VOLVO **RO** Set de fixare clip VOLVO **BG** Практичен комплект авто клипсове (щипки) за кори VOLVO



×350	for VOLVO	12 TYPES				
HT8G553	270 x 170 mm	1	25			

**DE** Befestigungs Clip TOYOTA, LEXUS **EN** Trim clips assortment TOYOTA, LEXUS **FR** Ensemble des clips de garniture TOYOTA, LEXUS **ES** Conjunto de clips de recorte TOYOTA, LEXUS **HR** Kopče za automobile TOYOTA, LEXUS **HU** Rögzítő klipsz készlet TOYOTA, LEXUS **RO** Set de fixare clip TOYOTA, LEXUS **BG** Практичен комплект авто клипсове (щипки) за кори TOYOTA, LEXUS



×360	for VOLVO/LEXUS	18 TYPES				
HT8G554	270 x 170 mm	1	25			

**DE** Befestigungs Clip AUDI **EN** Trim clips assortment AUDI **FR** Ensemble des clips de garniture AUDI **ES** Conjunto de clips de recorte AUDI **HR** Kopče za automobile AUDI **HU** Rögzítő klipsz készlet AUDI **RO** Set de fixare clip AUDI **BG** Практичен комплект авто клипсове (щипки) за кори AUDI



×160	for AUDI	12 TYPES				
HT8G561	270 x 170 mm	1	25			

**DE** Befestigungs Clip HONDA **EN** Trim clips assortment HONDA **FR** Ensemble des clips de garniture HONDA **ES** Conjunto de clips de recorte HONDA **HR** Kopče za automobile HONDA **HU** Rögzítő klipsz készlet HONDA **RO** Set de fixare clip HONDA **BG** Практичен комплект авто клипсове (щипки) за кори HONDA



×418	for HONDA	18 TYPES				
HT8G555	270 x 170 mm	1	25			

**DE** Befestigungs Clip MAZDA **EN** Trim clips assortment MAZDA **FR** Ensemble des clips de garniture MAZDA **ES** Conjunto de clips de recorte MAZDA **HR** Kopče za automobile MAZDA **HU** Rögzítő klipsz készlet MAZDA **RO** Set de fixare clip MAZDA **BG** Практичен комплект авто клипсове (щипки) за кори MAZDA



×475	for MAZDA	18 TYPES				
HT8G556	270 x 170 mm	1	25			

**DE** Befestigungs Clip OPEL **EN** Trim clips assortment OPEL **FR** Ensemble des clips de garniture OPEL **ES** Conjunto de clips de recorte OPEL **HR** Kopče za automobile OPEL **HU** Rögzítő klipsz készlet OPEL **RO** Set de fixare clip OPEL **BG** Практичен комплект авто клипсове (щипки) за кори OPEL



×300	for OPEL	6 TYPES				
HT8G557	270 x 170 mm	1	25			

**DE** Befestigungs Clip FORD **EN** Trim clips assortment FORD **FR** Ensemble des clips de garniture FORD **ES** Conjunto de clips de recorte FORD **HR** Kopče za automobile FORD **HU** Rögzítő klipsz készlet FORD **RO** Set de fixare clip FORD **BG** Практичен комплект авто клипсове (щипки) за кори FORD



×415	for FORD	18 TYPES				
HT8G558	270 x 170 mm	1	25			

**DE** Befestigungs Clip BMW **EN** Trim clips assortment BMW **FR** Ensemble des clips de garniture BMW **ES** Conjunto de clips de recorte BMW **HR** Kopče za automobile BMW **HU** Rögzítő klipsz készlet BMW **RO** Set de fixare clip BMW **BG** Практичен комплект авто клипсове (щипки) за кори BMW



×290	for BMW	6 TYPES				
HT8G559	270 x 170 mm	1	25			

**DE** Befestigungs Clip VW **EN** Trim clips assortment VW **FR** Ensemble des clips de garniture VW **ES** Conjunto de clips de recorte VW **HR** Kopče za automobile VW **HU** Rögzítő klipsz készlet VW **RO** Set de fixare clip VW **BG** Практичен комплект авто клипсове (щипки) за кори VW



×255	for VW	12 TYPES				
HT8G560	270 x 170 mm	1	25			



**HÖGERT**  
technik

DE Werkstattwerkzeuge  
EN Workshop Tools  
FR Outillage D'atelier  
ES Herramientas De Taller  
HR Alati Za Radionice  
HU Műhelyszerszámok  
RO Scule De Atelier  
BG Работни Инструменти





DE Berührungsloses Infrarot-Thermometer EN Non contact infrared thermometer FR Thermomètre sans contact ES Termómetro sin contacto HR Beskontaktni termometar HU Erintés nélküli hőmérő RO Termometru fără contact BG Безконтактен термометър

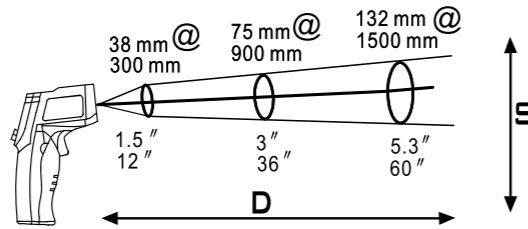

D:S  
=12:1

-50°C  
+550°C

HT8G429	1	50

DE Werkstattlampe EN Work light torch FR Torche d'inspection ES Linterna para inspección HR Inspeksijska svjetiljka HU Ellenőrző zseblámpa RO Lanternă de inspecție BG Инспекционен фенер



COB 3W  
LED 3W  
ABS  
MAGNETIC

18 m  
16 m  
AAA 1.5V  
x3

HT1E402	160 lm	12	96

DE Werkstattlampe EN Workshop lamp FR Torche d'inspection ES Linterna para inspección HR Inspeksijska svjetiljka HU Műhelylámpa RO Lampă de atelier BG Работна лампа



5 W COB  
+2-3 W LED  
3.7 V  
2000 mAh  
POWER BANK function with USB  
IP54

max 2-2.5 h  
3 h  
2 x MAGNETIC  
HOOK

HT1E407	400 lm + 200 lm	25	50

DE Werkstattlampe EN Workshop lamp FR Torche d'inspection ES Linterna para inspección HR Inspeksijska svjetiljka HU Műhelylámpa RO Lampă de atelier BG Работна лампа



10 W COB  
3.7 V  
2000 mAh  
IP54  
LIGHT CONTROL  
max 2-2.5 h

3 h  
direct USB  
MAGNETIC  
HOOK

HT1E409	400 lm	25	50

DE Taschenlampe EN Pocket flashlight FR Lampe de poche ES Linterna de bolsillo HR Džepna svjetiljka HU Kézilámpa RO Lanternă BG Фенер



LED  
IP20  
5 W  
AI  
6400 K

200 m  
AA/14500 3.7V  
x1  
AAA NOT INCLUDED  
40 000h  
A+  
S.O.S. ZOOM

HT1E424	250 lm	20	80



DE Taschenlampe EN Pocket flashlight FR Lampe de poche ES Linterna de bolsillo HR Džepna svjetiljka HU Kézilámpa RO Lanternă BG Фенер



10W	Li-Ion 3.7V 4000mAh	IP54	max 5-5.5h	Alu Alloy
ZOOM	4 modes 100%, 50%, S.O.S., Flashing	4h	direct USB	
HT1E425	800 lm	20	40	

DE Stirnlampe EN Headlamp FR Lampe frontale ES Linterna para casco de seguridad HR Čeona svjetiljka HU Homloklámpa RO Lanternă frontală BG Челник





LED	IP 20	LED 3W	ABS	10m
AAA 1.5V x3	NOT INCLUDED	40 000h	3 modes 100%, 50%, S.O.S.	6400 K
HT1E420	160 lm	12	48	

DE Teleskop inspektionsspiegel EN Inspection mirror FR Miroir d'inspection ES Espejo de inspección HR Okruglo inspeksijsko ogledalo HU Ellenőrző tükör RO Oglindă de inspecție BG Инспекционно огледало



TELESCOPIC max 715 mm	ERGO GRIP			
HT4R502	52 mm	715 mm	12	72

DE Magnetheber EN Magnetic pick up tool FR Outil magnétique ES Extractor de imán HR Teleskopski magnetski držač HU Mágneses felszedő RO Suport magnetic BG Магнитен държач за инструменти



TELESCOPIC max 640 mm	MAGNETIC	2.7 kg max		
HT4R506	135-640 mm	12	72	

DE Led Werkstattlampe EN Workshop lamp FR Portable LED Lampe ES Lámpara portátil HR Prijenosna rasvjeta HU Hordozható lámpatest RO Corp de iluminat portabil BG Преносимо осветително тяло



LED	inside	A+	5W	6400 K
AC 100-250V/ 50-60 Hz	IP 54	H05RN-F 2x1.00 mm²	PF>0.5	40 000h
ON OFF x20 000	5 m	ABS	HOOK	20m
HT1E410	350 lm	1	40	

DE Akku strahler EN Floodlight FR Torche d'inspection ES Linterna para inspección HR Inspeksijska svjetiljka HU Megvilágító RO Projector BG Прожектор

2x10 W COB	Li-Ion 3.7V 4400 mAh	POWER BANK function with USB	IP 54	3 MODES
max 4-5.5h	4 h	HANDLE & STAND	TPR PROTECTION	direct USB
HT1E430	1150 lm	1	20	

DE Teleskop inspektionsspiegel EN Inspection mirror FR Miroir d'inspection ES Espejo de inspección HR Pravokutno inspeksijsko ogledalo HU Ellenőrző tükör RO Oglindă de inspecție BG Инспекционно огледало



50x80 mm	TELESCOPIC max 880 mm	ERGO GRIP	LR 44 x 3	LED
HT4R504	300-880 mm	12	72	

DE Magnetheber EN Magnetic pick up tool FR Outil magnétique ES Extractor de imán HR Magnetski držač HU Mágneses felszedő RO Suport magnetic BG Магнитен държач за инструменти





TELESCOPIC max 810 mm	MAGNETIC	3.6 kg max		
ERGO GRIP	LR 44 x 3	LED		
HT4R508	195-810 mm	12	72	

DE Magnetheber EN Magnetic pick up tool FR Outil magnétique ES Extractor de imán HR Magnetski držač HU Mágneses felszedő RO Suport magnetic BG Магнитен държач за инструменти



TELESCOPIC max 570 mm	FLEXIBLE	MAGNETIC	2.2 kg max	
ERGO GRIP	LR 44 x 4	LED		
HT4R507	170-570 mm	20	100	

DE Magnetheber EN Magnetic pick up tool FR Outil magnétique avec pince ES Extractor de imán HR Magnetski držač HU Megfogószerkezet RO Dispozitiv de arucare BG Хващач

620 mm	FLEXIBLE	1 kg max		
CHUCK & LED	LR 44 x 3	LED		
HT4R510	610 mm	12	72	

DE Magnet Werkzeughalter mit schale Satz EN Magnetic holder set FR Barres magnétiques et bac de rangement ES Portaherramientas magnético HR Magnetne letve i posudica, 3 kom. HU Mágneses lécek és dob RO Benzi și bol magnetic BG Ленти и магнитна купа





MAGNETIC	x3	10 kg		
460 mm	140x240 mm	INOX		
HT4R522	460 mm (19 x 395 mm) 23,8 x 13,8 x 20 mm	1	5	

DE Magnetwerkzeughalter EN Magnetic holder set FR Porte-outil magnétique ES Listón magnético HR Magnetne letve, 3 kom. HU Mágneses szerszámtartó RO Bandă magnetică BG Магнитна лента



MAGNETIC	10 kg	x3	STEEL	
HT4R521	200 mm (19 x 150 mm) 300 mm (19 x 248 mm) 460 mm (19 x 395 mm)	6	12	

DE Magnetheber EN Magnetic pick up tool FR Outil magnétique ES Extractor de imán HR Magnetski držač HU Mágneses felszedő RO Suport magnetic BG Магнитен държач за инструменти

510 mm	FLEXIBLE	1 kg max		
HT4R509	510 mm	12	120	

DE Magnetschale EN Magnetic tray FR Plateau magnétique ES Plato magnético HR Magnetska zdjela HU Mágneses csavargyűjtő tálcá RO Bol magnetic BG Магнитна купа



150 mm	MAGNETIC	25 mm	INOX	
HT4R512	∅ 150 mm	25 mm	1	36

DE Magnetwerkzeughalter EN Magnetic tool holder FR Porte-outil magnétique ES Listón magnético HR Magnetska letva HU Mágneses szerszámtartó RO Bandă magnetică BG Магнитна лента



460 mm	MAGNETIC	13 kg MAX	STEEL	
HT4R520	460 mm	4	16	

DE Magnet für schlagschrauber EN Magnetic holder FR Support magnétique pour clé à chocs et douilles ES Soporte magnético HR Magnetni držač HU Mágneses felszedő RO Suport magnetic BG Магнитен държач за инструменти



MAGNETIC	1,4 kg	STEEL/ PVC	40 mm	
HT4R519		6	48	

DE Magnet für schlagschrauber EN Magnetic holder FR Support magnétique pour clé à chocs et douilles ES Soporte magnético HR Magnetni držač za pneumatski ključ HU Mágneses felszedő RO Suport magnetic BG Магнитен държач за инструменти



HT4R518	1	10

DE Magnetische Schutzmatte EN Magnetic protection matt FR Tapis de protection magnétique ES Alfombra protectora magnética HR Magnetska zaštitna prostirka HU Mágneses védőszőnyeg RO Covor de protecție magnetic BG Магнитна работна подложка



HT8G437	590 x 790 mm	1	40

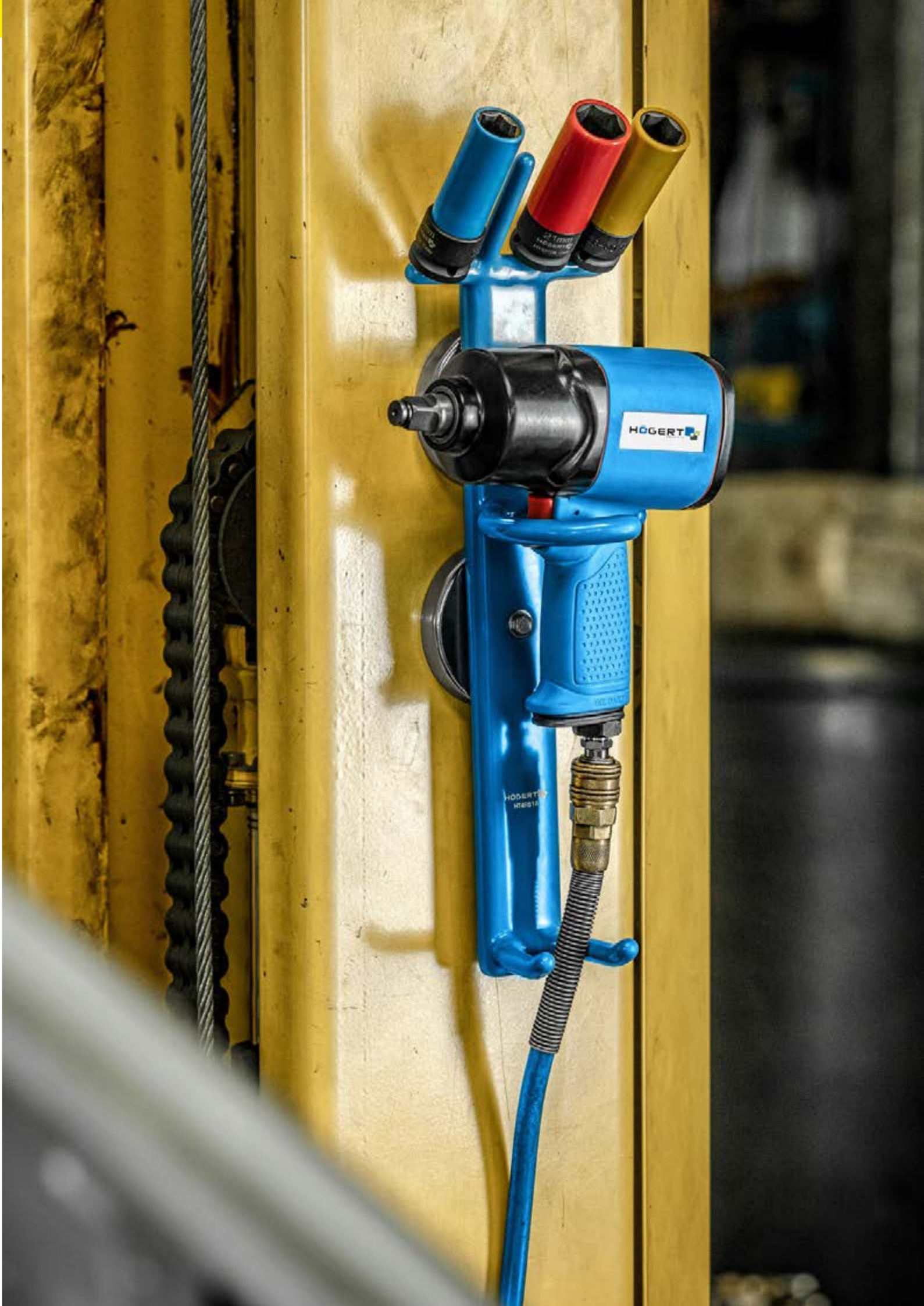



DE Werkzeuge Für Elektriker  
EN Tools For Electricians  
FR Outils Pour Electriciens  
ES Herramientas Para Electricistas  
HR Alati Za Električare  
HU Villanyszerelési Szerszámok  
RO Instrumente Pentru Electricieni  
BG Инструменти За Елетротехници



DE Universell digital Messgerät EN Universal digital meter FR Multimètre numérique ES Multímetro digital universal HR Višenamjenski mjerač sa zaslonom HU Digitális multiméter RO Multimetru digital BG Мултицет дигитален



AUTO-RANGE	U.D.C. 600V U.A.C. 600V	I.D.C. 10A
R 2MΩ	DATA HOLD	LED DIODE
1999 DISPLAY	BATTERY 1,5 / 9V	

HT1E602	160 x 75 x 30 mm	1	50
---------	------------------	---	----

DE Universell digital Messgerät EN Universal digital meter FR Multimètre numérique ES Multímetro digital universal HR Višenamjenski mjerač sa zaslonom HU Digitális multiméter RO Multimetru digital BG Мултицет дигитален



AUTO-RANGE	TRUE RMS	U.D.C. 600V U.A.C. 600V	I.D.C. 10A I.A.C. 10A
R 40 MΩ	-20°C -1000°C	5-5 MHz	DATA HOLD
RELATIVE			3999 DISPLAY

HT1E603	160 x 75 x 30 mm	1	50
---------	------------------	---	----

DE Universelles digitales Messgerät FULL-SMART EN Universal digital meter FULL-SMART FR Multimètre numérique avec technologie FULL-SMART ES Medidor digital universal FULL-SMART HR FULL-SMART digitalni mjerač HU FULL-SMART digitális multiméter RO FULL-SMART multimetru digital BG Мултицет дигитален универсален FULL SMART



NCV	TRUE RMS	SMART	U.D.C. 600V U.A.C. 600V
I.D.C. 10A I.A.C. 10A	R 60MΩ	C 60mF	20 MHz
DATA HOLD	6000 DISPLAY		

HT1E605	121 x 60 x 36 mm	1	50
---------	------------------	---	----

DE Universelles digitales Messgerät FULL-SMART EN Universal digital meter FULL-SMART FR Multimètre numérique universel FULL-SMART ES Medidor digital universal FULL-SMART HR FULL-SMART digitalni mjerač HU FULL-SMART digitális multiméter RO FULL-SMART multimetru digital BG Мултицет дигитален универсален FULL SMART



NCV	TRUE RMS	SMART	U.D.C. 600V U.A.C. 600V
R 40 MΩ	C 40mF	4 MHz	DATA HOLD
4000 DISPLAY			

HT1E615	204 x 39 x 30 mm	1	100
---------	------------------	---	-----

DE Universell digital Messgerät EN Universal digital meter FR Multimètre numérique ES Multímetro digital universal HR Višenamjenski mjerač sa zaslonom HU Digitális multiméter RO Multimetru digital BG Мултицет дигитален



NCV	TRUE RMS	AUTO-RANGE	U.D.C. 600V U.A.C. 600V
I.D.C. 10A I.A.C. 10A	R 99,99MΩ	C 99,99mF	BATTERY 1,5 / 9V
DATA HOLD	VFC	LED DIODE	9999 DISPLAY

HT1E600	150 x 70 x 50 mm	1	40
---------	------------------	---	----

DE Universell digital Messgerät EN Universal digital meter FR Multimètre numérique ES Multímetro digital universal HR Višenamjenski mjerač sa zaslonom HU Digitális multiméter RO Multimetru digital BG Мултицет дигитален



NCV	TRUE RMS	SMART U AC/DC	AUTO-RANGE
U.D.C. 600V U.A.C. 600V	I.D.C. 10A I.A.C. 10A	R 99,99MΩ	C 10 mF
BATTERY 1,5 / 9V	DATA HOLD	LED DIODE	9999 DISPLAY

HT1E601	150 x 70 x 50 mm	1	40
---------	------------------	---	----

DE Universell digital Messgerät EN Universal digital meter FR Multimètre numérique ES Multímetro digital universal HR Višenamjenski mjerač sa zaslonom HU Digitális multiméter RO Multimetru digital BG Мултицет дигитален



SELECT	4000 DISPLAY	U.D.C. 2000 V U.A.C. 2000 V	I.D.C. 400 mA I.A.C. 400 mA
R 400MΩ	C 400 uF	-40°C -1000°C -4°F -1832°F	4MHz
hFE PNP NPN	DATA HOLD		

HT1E606	1	40
---------	---	----

DE Universell digital Messgerät EN Universal digital meter FR Multimètre numérique ES Multímetro digital universal HR Višenamjenski mjerač sa zaslonom HU Digitális multiméter RO Multimetru digital BG Мултицет дигитален



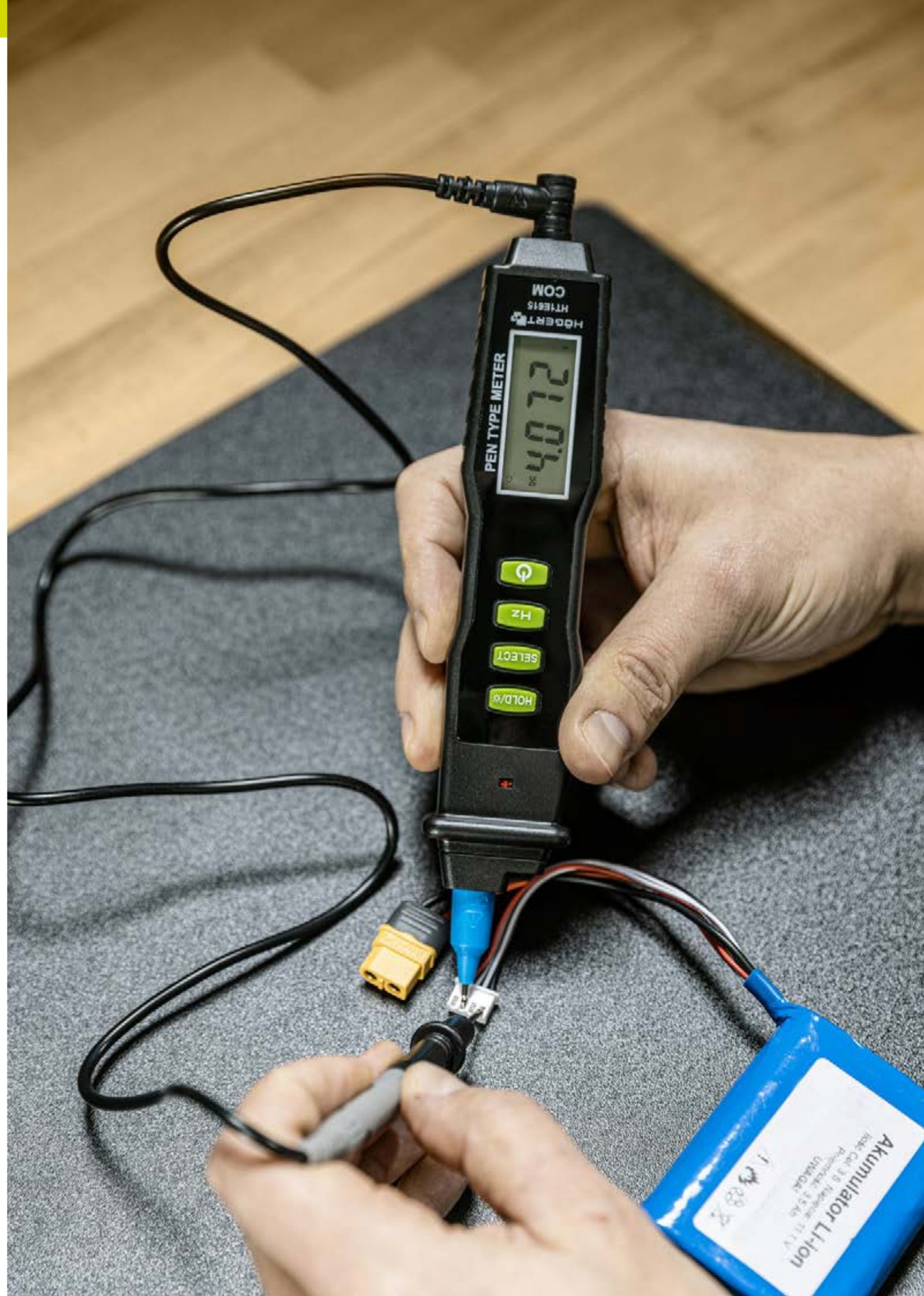

TRUE RMS	AUTO-RANGE	SELECT	RANGE
RELATIVE	U.D.C. 600V U.A.C. 600V	I.D.C. 10A I.A.C. 10A	R 60MΩ
C 60mF	-20°C -1000°C	0-10 MHz	DATA HOLD

HT1E604	190 x 90 x 40 mm	1	20
---------	------------------	---	----





DE Universell Klemme Messgerät EN Universal clamp meter FR Pince ampèremétrique ES Multímetro pinza universal HR Mjerna klješta HU Univerzális lakatfogó multiméter RO Clampmetru digital BG Ампер клещи дигитални

NCV	TRUE RMS	AUTO-RANGE	U.D.C. 600V U.A.C. 600V
I.A.C. 600A	R 60MΩ	DATA HOLD	VFC
Low Z			

HT1E620	1	20
---------	---	----

DE Universal clamp meter EN Universell Klemme Messgerät FR Pince ampère-métrique ES Multímetro pinza universal HR Mjerna klješta HU Univerzális lakatfogó multiméter RO Clampmetru digital BG Ампер клещи дигитални

NCV	TRUE RMS	AUTO-RANGE	U.D.C. 600V U.A.C. 600V	I.A.C. 600A
R 60MΩ	MAX Ø20 mm	DATA HOLD	MIN/MAX	SELECT
		RANGE		5999 DISPLAY

HT1E621	1	20
---------	---	----

DE Kabel Verfolger EN Cable tracker FR Détecteur de câbles ES Trazador de cable HR Detektor kablova HU Vezeték detektor RO Detector de cabluri BG Цифров детектор



NCV	RJ11 RJ45	
-----	--------------	--

HT1E640	RJ11, RJ45	1	40
---------	------------	---	----

DE Spannungsprüfer EN Voltage tester FR Testeur de tension ES Medidor de voltaje HR Električni tester HU Fázisceruza RO Surubelnite de tensiune BG Фазомер



SL3	AC 100-500V	140 mm
-----	-------------	--------

HT1S982	140 mm	30	600
---------	--------	----	-----

DE Spannungsprüfer EN Voltage tester FR Testeur de tension ES Medidor de voltaje HR Električni tester HU Fázisceruza RO Surubelnite de tensiune BG Фазомер



SL3	AC 100-500V	150 mm
-----	-------------	--------

HT1S981	150 mm	12	240
---------	--------	----	-----

DE Spannungsprüfer EN Induction voltage tester FR Testeur de tension par induction ES Probador De Voltaje Eléctrico HR Beskontaktni ispitivač napona HU Induktív feszültségvizsgáló RO Tester de tensiune inductiva BG Детектор на напрежение

NCV	12-1000V	48-1000V
LED	ON/OFF	

HT1E630	12-1000 V 48-1000 V	1	120
---------	------------------------	---	-----

DE Kombinationszange 1000 V EN Insulated combination pliers 1000 V FR Pince combinée isolée 1000 V ES Alicates universales 1000 V HR Univerzalna klješta 1000 V HU Kombinált fogó 1000 V RO Cleste combinat 1000 V BG Клещи комбинирани 1000V



VDE 1000V	CrV	HRC 55-60	DIN 5749
-----------	-----	-----------	----------

HT1P903	160 mm	6	60
HT1P905	180 mm	6	60
HT1P907	200 mm	6	60

DE Seitenschneider 1000 V EN Insulated diagonal side cutters 1000 V FR Coupe-bordures diagonales isolées 1000 V ES Alicates de corte 1000 V HR Bočna klješta 1000 V HU Oldalsíró fogók 1000 V RO Cleste cu taietura laterala 1000 V BG Клещи резачки 1000V



VDE 1000V	CrV	HRC 55-60	DIN 5749	HIGH LEVERAGE
-----------	-----	-----------	----------	---------------

HT1P909	160 mm	6	60
HT1P911	180 mm	6	60

DE Verlängerte Zange 1000 V EN Elongated, straight pliers 1000 V FR Pince à becs droits 1000 V ES Alicates alargados rectos 1000 V HR Izdužena ravna klješta 1000 V HU Rádiós fogó 1000 V RO Cleste cu varf lung 1000 V BG Клещи плоскоустни удължени 1000V



VDE 1000V	CrV	HRC 55-60	DIN 5745	PTFE COAT
-----------	-----	-----------	----------	-----------

HT1P913	160 mm	6	60
HT1P917	200 mm	6	60

DE Abisolierzange 1000 V EN Wire stripper pliers 1000 V FR Pince à dénuder isolée 1000 V ES Alicates pelacables 1000 V HR Klješta za skidanje izolacije 1000 V HU Vezeték csupaszoló fogó 1000 V RO Cleste de dezizolare 1000 V BG Клещи за свяляне на изолация 1000V



VDE 1000V	CrV	HRC 55-60	DIN 5745	PTFE COAT
-----------	-----	-----------	----------	-----------

HT1P931	160 mm	6	60
---------	--------	---	----

DE Kabelschere EN Electrician's shears FR Ciseaux pour électricien ES Tijera Electricista HR Škare za rezanje žica i izolacije HU Villanyzerelő olló RO Foarfeca pentru taiat cablu BG Ножици за рязанена кабели и изолация



CUT COPPER -0,5mm	48-52 HRC	CUTTING NOTCH	SS	ERGO GRIP
-------------------	-----------	---------------	----	-----------

HT1P040	140 mm	10	120
---------	--------	----	-----

DE Kraft-Seitenschneider EN Cable cutter pliers FR Pince coupante de câble ES Alicates cortacables HR Klješta za rezanje žica i kablova HU Vezetékvágó fogók RO Cleste pentru taiat cablu BG Клещи за рязане на кабели



ERGO GRIP	LOCK	CrV
Cu, Al, PCV	Ø max 10,5mm	16~8 AWG

HT1P045	185 mm	1,3 - 8,0 mm <sup>2</sup> (16, 14, 12, 10, 8 AWG)	10	120
---------	--------	---	----	-----

DE Verlängerte Zange gewinkelt 1000V EN Elongated, bent pliers 1000V FR Pince à becs courbés 1000 V ES Alicates alargados curvos 1000 V HR Izdužena zakrivljena klješta 1000 V HU Hajlított rádiós fogó 1000 V RO Cleste cu varf lung, curb, 1000 V BG Клещи тип "човки" удължени 1000V



VDE 1000V	CrV	HRC 55-60	DIN 5745	PTFE COAT
-----------	-----	-----------	----------	-----------

HT1P919	160 mm	6	60
HT1P923	200 mm	6	60



DE Abisoliermesser, zum Abmanteln aller gängigen EN Cable stripper FR Couteau à dénager ES Alicates Pelacables HR Alat za skidanje izolacije s oštricom HU Vezeték csupaszoló RO Dispozitiv dezizolat BG Нож за кабели и изолация



Ø 8-28 mm	ADJUSTABLE	ERGO GRIP
-----------	------------	-----------

HT1P189	170 mm	Ø 8-28 mm	12	48
---------	--------	-----------	----	----

DE Kraft-Seitenschneider EN Cable cutter pliers FR Pince coupante de câble ES Alicates cortacables HR Klješta za rezanje žica i kablova HU Vezetékvágó fogók RO Cleste pentru taiat cablu BG Клещи за рязане на кабели

ERGO GRIP	16 AWG	FLAT
-----------	--------	------

HT1P041	125 mm	max 0,5 - 1,3 mm <sup>2</sup> (16 AWG)	12	144
---------	--------	--	----	-----

DE Kraft-Seitenschneider EN Cable cutter pliers FR Pince coupante de câble ES Alicates cortacables HR Klješta za rezanje žica i kablova HU Vezetékvágó fogók RO Cleste pentru taiat cablu BG Клещи за рязане на кабели



2,5-8,0 mm <sup>2</sup>	14-8 AWG	max 12 mm
Al Cu	SK5	

HT1P047	170 mm	2,5 - 8,0 mm <sup>2</sup> (14-8 AWG)	10	60
---------	--------	--------------------------------------	----	----

DE Kabelzange EN Cable cutting pliers FR Pince coupe-câble ES Alicates cortacables HR Klijesta za rezanje kablova HU Vezetékvágó fogók RO Cleste pentru taiat cablu BG Клеци за рязане на кабели



Ø max 10.5 mm	AI Cu	STRIPPING KNIFE			
LOCK	SK5	ERGO GRIP			
HT1P046	168 mm	Ø 10,5 mm	10	60	

DE Kabelschneider EN Cable Cutter FR Coupe-câble ES Cortador de cables HR Škare za kablove HU Vezetékvágó RO Cleste pentru taiat cablu cu maner lung BG Ножици за рязане на кабели



CrV	Al	Cu			
MAX Ø22 mm	MAX Ø26 mm	ERGO GRIP			
HT1P048	450 mm	1	12		
HT1P049	600 mm	1	12		

DE Kable Abisolierer EN Wire stripper FR Pince à dénuder ES Pelacables HR Alat za skidanje izolacije HU Csúszóló RO Dispozitiv dezizolat BG Нож за заголване на изолация



4P 6P 8P	RG 6	RG 59			
TRISSET 113 Profi 11	SK5				
HT1P103	125 mm	RG-6, RG-59, Triset-113, Triset Profi, Triset-11	10	50	

DE Abisolierzange für Lichtfaser Leitungen EN Fibre optic wire stripper FR Pince à dénuder fibre optique ES Alicates Pelacables fibra óptica HR Klijesta za skidanje izolacije sa svijetlovodnih kabela HU Optikai kábel csúszóló RO Cleste dezizolator pentru cabluri cu fibre optice BG Клеци за рязане и заголване на оптични кабели



FOR FIBRE OPTIC WIRE	µm 250	µm 600-900			
HIGH PRECISION	ERGO GRIP				
HT1P186	145 mm	2,8-3,0 mm and 2,0-3,0 mm	10	60	

DE Kabelzange EN Cable cutting pliers FR Pince coupante pour câble ES Alicates cortacables HR Klijesta za rezanje kablova HU Vezetékvágó fogók RO Cleste pentru taiat cablu BG Клеци за рязане на кабели



AI Cu	CrV	ERGO GRIP			
HT1P042	160 mm	Ø 3 mm	6	60	
HT1P044	200 mm	Ø 11 mm	6	60	

DE Kable Abisolierer EN Wire stripper FR Pince à dénuder ES Pelacables HR Alat za skidanje izolacije HU Csúszóló RO Dispozitiv dezizolat BG Нож за заголване на изолация





0,5-5,0 mm²	20-10 AWG	8-13 mm²			
RG 6	RG 59	SK5			
HT1P102	122 mm	0,5-6,0 mm² (20-10 AWG)	15	90	

DE Kable Abisolierer EN Wire stripper FR Pince à dénuder ES Pelacables HR Alat za skidanje izolacije HU Csúszóló RO Dispozitiv dezizolat BG Нож за заголване на изолация



PVC/PE/RR/RN	REPLACEABLE BLADE				
BOTH END	0-30 mm SCALE				
HT1P104	>25 mm²	0 - 5 mm	10	50	

DE Kable Abisolierer EN Wire stripper FR Pince à dénuder ES Pelacables HR Alat za skidanje izolacije HU Csúszóló RO Dispozitiv dezizolat BG Нож за заголване на изолация

0,5-5,5 mm² AWG 22-10					
7-8 mm SPARK PLUG WIRES	M	2,5-6,0			
HT1P220	215 mm	0,5-6,0 mm² (22-10 AWG)	12	72	

DE Automatische Abisolierzange EN Automatic wire stripper FR Pince automatique à dénuder ES Alicates Pelacables automático HR Automatski alat za skidanje izolacije HU Automata vezetékcspaszoló RO Cleste de dezizolat automat BG Автоматични клещи за рязане и заголване на оптични кабели





CUTTER	LENGTH STOP	FORCE ADJUSTMENT			
HT1P185	170 mm	0,25 - 25 mm²	12	72	

DE Automatische Abisolierzange EN Automatic wire stripper FR Pince automatique à dénuder ES Alicates Pelacables automático HR Automatski alat za skidanje izolacije HU Automata vezetékcspaszoló RO Cleste de dezizolat automat BG Автоматични клещи за рязане и заголване на оптични кабели



1,0-3,2 mm²	18-12 AWG	SK5	ERGO GRIP		
HT1P188	168 mm	1,0-3,2 mm² (18-12 AWG)	8	48	

DE Automatische Abisolierzange EN Automatic wire stripper FR Pince à dénuder automatique ES Alicates Pelacables automático HR Automatska klijesta za skidanje izolacije HU Automata vezetékcspaszoló RO Cleste dezizolator automat BG Автоматични клещи за рязане и заголване на оптични кабели

HIGH PRECISION	CABLE CUTTER	ERGO GRIP			
HT1P184	205 mm	0,25-6,0 mm² (23-10 AWG)	10	60	

DE Crimp-Hebelzange für Westernstecker EN Telephone connector crimping plier FR Pince à sertir pour téléphone ES Tenazas crimpadoras para cables de telefonía HR Klijesta za prešanje za telefonske i računalne stezaljke HU Telefon és internet csatlakozó prés RO Cleste de serizat pentru conector telefonice si informatice BG Клеци за кримпване на телефонни букси



RJ11	RJ12	RJ45			
6P	8P	CUTTER			
HT1P171	200 mm	6P, 8P	10	40	

DE Automatische Abisolierzange EN Automatic wire stripper FR Pince automatique à dénuder ES Alicates Pelacables automático HR Automatski alat za skidanje izolacije HU Automata vezetékcspaszoló RO Cleste de dezizolat automat BG Автоматични клещи за рязане и заголване на оптични кабели





0,2-6,0 mm²	24-10 AWG	SK5	ERGO GRIP		
HT1P187	180 x 170 x 32 mm	0,2 - 6,0 mm² (24-10 AWG)	10	60	

DE Automatische Abisolierzange EN Automatic wire stripper FR Pince à dénuder automatique ES Alicates Pelacables automático HR Automatska klijesta za skidanje izolacije HU Automata vezetékcspaszoló RO Cleste dezizolator automat BG Автоматични клещи за рязане и заголване на оптични кабели



0,2-6,0 mm²	24-10 AWG	CR12MoV STEEL BLADES			
HIGH PRECISION	ERGO GRIP				
HT1P181	205 mm	0,2-6,0 mm² (24-10 AWG)	10	40	

DE Automatische Abisolierzange EN Automatic wire stripper FR Pince à dénuder automatique ES Alicates Pelacables automático HR Automatska klijesta za skidanje izolacije HU Automata vezetékcspaszoló RO Cleste dezizolator automat BG Автоматични клещи за рязане и заголване на оптични кабели

0,05-10 mm²	30-8 AWG	CUTTER SK5			
STRIPPER SK5	HIGH PRECISION	ERGO GRIP			
HT1P182	210 mm	0,05 to 10,0 mm² (30-8 AWG)	10	60	

DE Crimp-Hebelzange für Westernstecker EN Telephone connector crimping plier FR Pince à sertir pour téléphone ES Tenazas crimpadoras para cables de telefonía HR Klijesta za prešanje za telefonske i računalne stezaljke HU Telefon és internet csatlakozó prés RO Cleste de serizat pentru conector telefonice si informatice BG Клеци за кримпване на телефонни букси



RJ10	RJ11	RJ12	RJ45	4P	
6P	8P	10P	CUTTER		
HT1P170	200 mm	4P, 6P, 8P, 10P	10	40	

**DE** Crimpzange für Telefonstecker **EN** Telephone connector crimping plier **FR** Outil de sertissage de connecteur téléphone **ES** Tenaza crimpadoras para conectores de telefonía **HR** Alat za prešanje telefonskih i računalnih stezaljki **HU** Telefon csatlakozó prés **RO** Cleste de sertizat pentru conector telefonic **BG** Клещи за кримпване на телефонни букси



6P	8P	RJ45	CUTTER SK5
HIGH PRECISION	EASY CRIMPING	ERGO GRIP	
HT1P172	137 mm	6P, 8P, RJ45	8 48

**DE** Crimpzange, Set mit 6 wechselbaren Einsätzen **EN** Crimping plier interchangeable **FR** Pince à sertir interchangeable **ES** Tenaza crimpadora con mordazas intercambiables **HR** Klijesta za stezanje sa izmenljivim čeljustima **HU** Cserélhető betétes prészerszám **RO** Cleste de sertizat cu falci interschimbabile **BG** Комплект кримпващи клещи с части



A	0.5-6 mm² (22-10 AWG)
A1	0.5-10 mm² (22-8 AWG)
A2	0.5-6 mm² (22-10 AWG)
A3	0.1-1.5 mm² (26-16 AWG)
A4	0.5-2.5 mm² (22-14 AWG)
A5	0.5-6 mm² (22-10 AWG)

x7	QUICK EXCHANGE	RATCHET	ERGO GRIP
HT1P176	220 mm	1	10

**DE** Crimpzange für unisolierte Schiebekabelschuhe **EN** Non-insulated terminal crimping plier **FR** Pince à sertir **ES** Tenaza crimpadora para terminales no aislados **HR** Klijesta za stezanje neizoliranih, kliznih stezaljki **HU** Szigeteletlen csúszó saru prés **RO** Cleste de sertizat **BG** Клещи за кримпване на неизолирани кабелни обувки



0.08-2.0 mm² AWG 28-14	0.3-6.0 mm² AWG 22-10		
0.12-0.3 mm² AWG 26-22	CUTTER		
HT1P215	180 mm	0,08-2,0 mm² (28-14 AWG)	12 72

**DE** Crimpzange für Aderendhülsen **EN** Insulated terminal crimping pliers **FR** Pince à sertir isolée **ES** Tenaza crimpadora para terminales aislados **HR** Klijesta za stezanje izoliranih stezaljki **HU** Szigetelt saru prés **RO** Cleste de sertizat **BG** Клещи за кримпване на изолирани кабелни обувки



0.5-2.5 mm²	22-14 AWG	INSULATED	
ERGO GRIP	RATCHET		
HT1P160	191 mm	0,5 - 2,5 mm² (22-14 AWG)	6 36

**DE** Crimpzange **EN** Crimping plier **FR** Pince à sertir **ES** Crimpadora para terminales **HR** Klijesta za krimpjanje **HU** Krimpelő fogó **RO** Cleste sertizat **BG** Клещи за кримпване



0.5-6,0 mm²	22-10 AWG
0.5-4,0 mm²	22-12 AWG
6,5 / 5,4 / 1,7 mm	
0.5-6,0 mm²	22-10 AWG
0.5-16,0 mm²	22-6 AWG

x7	QUICK EXCHANGE	CUTTER	PH1
HT1P177	225 mm	0,6-2,6 mm² (22-10 AWG)	10 50

**DE** Crimpzange für unisolierte Schiebekabelschuhe **EN** Non-insulated terminal crimping plier **FR** Pince à sertir **ES** Tenaza crimpadora para terminales no aislados **HR** Klijesta za stezanje neizoliranih, kliznih stezaljki **HU** Szigeteletlen csúszó saru prés **RO** Cleste de sertizat **BG** Клещи за кримпване на неизолирани кабелни обувки



0.1-2.5 mm²	27-13 AWG	RATCHET	
HT1P200	225 mm	0,1 - 2,5 mm² (27-13 AWG)	10 40

**DE** Crimpzange für unisolierte Schiebekabelschuhe **EN** Non-insulated terminal crimping plier **FR** Pince à sertir **ES** Tenaza crimpadora para terminales no aislados **HR** Klijesta za stezanje neizoliranih, kliznih stezaljki **HU** Szigeteletlen csúszó saru prés **RO** Cleste de sertizat **BG** Клещи за кримпване на неизолирани кабелни обувки



1.5-6.0 mm²	16-10 AWG	RATCHET	
HT1P192	220 mm	1,5-6,0 mm² (16-10 AWG)	10 40

**DE** Crimpzange für isolierte Kabelschuhe **EN** Insulated terminal crimping plier **FR** Pince à sertir isolée **ES** Tenaza crimpadora aislada **HR** Klijesta za stezanje izoliranih stezaljki **HU** Szigetelt szemes saru prés **RO** Cleste de sertizat **BG** Клещи за кримпване на изолирани кабелни обувки



0.5-6.0 mm²	20-10 AWG	RATCHET	
HT1P194	220 mm	0,5-6,0 mm² (20-10 AWG)	10 40

**DE** Crimpzange für isolierte Kabelschuhe **EN** Insulated terminal crimping plier **FR** Pince à sertir isolée **ES** Tenaza crimpadora aislada **HR** Klijesta za stezanje izoliranih stezaljki **HU** Szigetelt szemes saru prés **RO** Cleste de sertizat **BG** Клещи за кримпване на изолирани кабелни обувки



0.5-6.0 mm²	20-10 AWG	RATCHET	
HT1P201	220 mm	0,5-6,0 mm² (20-10 AWG)	10 40

**DE** Crimpzange für dünnwandige Kabelschuhe **EN** Cord end terminal crimping pliers **FR** Pince à sertir idéale pour des travaux de telecommunications **ES** Tenaza crimpadora para cables terminal **HR** Klijesta za stezanje tankoslojnih čahura **HU** Érvéghüvely prés **RO** Cleste de sertizat **BG** Клещи за кримпване втулки накрайници



0.5-6.0 mm²	20-10 AWG	RATCHET	
HT1P195	220 mm	0,5-6,0 mm² (20-10 AWG)	10 40

**DE** Presszange für dünnwandige Hülsen **EN** Cord end terminal crimping pliers **FR** Pince à sertir idéale pour des travaux de telecommunications **ES** Tenaza crimpadora para cables terminal **HR** Klijesta za stezanje tankoslojnih čahura **HU** Érvéghüvely prés **RO** Cleste de sertizat **BG** Клещи за кримпване втулки накрайници



6-16 mm²	10-6 AWG	CORD END	
ERGO GRIP	RATCHET		
HT1P162	191 mm	6-16,0 mm² (10-6 AWG)	6 36

**DE** Crimpzange, selbsteinstellend **EN** Ferrule crimper wire plier **FR** Pince à sertir auto-réglable **ES** Tenaza crimpadora autoajustable **HR** Samopodesiva klijesta za stezanje tankoslojnih čahura **HU** Érvéghüvely krimpelő prés **RO** Cleste de sertizat **BG** Клещи за кримпване втулки накрайници



0.25-6.0 mm²	23-10 AWG	RATCHET	
HT1P190	175 mm	0,25-6,0 mm² (23-10 AWG)	10 40

**DE** Crimpzange für isolierte Kabelschuhe **EN** Insulated terminal crimping plier **FR** Pince à sertir isolée **ES** Tenaza crimpadora aislada **HR** Klijesta za stezanje izoliranih stezaljki **HU** Szigetelt szemes saru prés **RO** Cleste de sertizat **BG** Клещи за кримпване на изолирани кабелни обувки



0.5-6.0 mm²	20-10 AWG	RATCHET	
HT1P202	220 mm	0,5-6,0 mm² (20-10 AWG)	10 40

**DE** Crimpzange für dünnwandige Kabelschuhe **EN** Cord end terminal crimping pliers **FR** Pince à sertir idéale pour des travaux de telecommunications **ES** Tenaza crimpadora para cables terminal **HR** Klijesta za stezanje tankoslojnih čahura **HU** Érvéghüvely prés **RO** Cleste de sertizat **BG** Клещи за кримпване втулки накрайници



0.5-4.0 mm²	22-12 AWG	CORD END	ERGO GRIP	RATCHET
HT1P161	191 mm	0,5-4,0 mm² (22-12 AWG)	6 36	

**DE** Crimpzange für unisolierte Kabelschuhe **EN** Non-insulated terminal crimping plier **FR** Pince à sertir non isolée idéale pour des travaux de telecommunications **ES** Tenaza crimpadora para terminales no aislados **HR** Klijesta za stezanje neizoliranih stezaljki **HU** Szigeteletlen szemes saru prés **RO** Cleste de sertizat **BG** Клещи за кримпване на неизолирани кабелни обувки



1.0-10 mm²	20-8 AWG	RATCHET	
HT1P193	220 mm	1,0-10,0 mm² (20-8 AWG)	10 40

**DE** Crimpzange, selbsteinstellend **EN** Ferrule crimper wire plier **FR** Pince à sertir auto-réglable **ES** Tenaza crimpadora autoajustable **HR** Samopodesiva klijesta za stezanje tankoslojnih čahura **HU** Érvéghüvely krimpelő prés **RO** Cleste de sertizat **BG** Клещи за кримпване втулки накрайници



0.25-6.0 mm²	23-10 AWG	RATCHET	
HT1P205	175 mm	0,25-6,0 mm² (23-10 AWG)	10 50



DE Crimpzange, selbststellend EN Ferrule crimper wire plier FR Pince à sertir auto-réglable ES Tenaza crimpadora autoajustable HR Samopodesiva klijesta za stezanje tankoslojnih čahura HU Érvéhvély krimpelő prés RO Cleste de sertizat BG Клеци за кримпване втулки на крайници



4-16 mm <sup>2</sup>	6-12 AWG	RATCHET	HT1P191	210 mm	4 - 16 mm <sup>2</sup> (6-12 AWG)	10	40
----------------------	----------	---------	---------	--------	-----------------------------------	----	----

DE Crimpzange für KOAX-Kabelschuhe EN Coaxial connector terminal crimping pliers FR Pince à sertir coaxial ES Crimpadora cable coaxial HR Klijesta za stezanje stezaljki HU Koax csatlakozó prés RO Cleste de sertizat pentru conector coaxial BG Клеци за кримпване тип коак

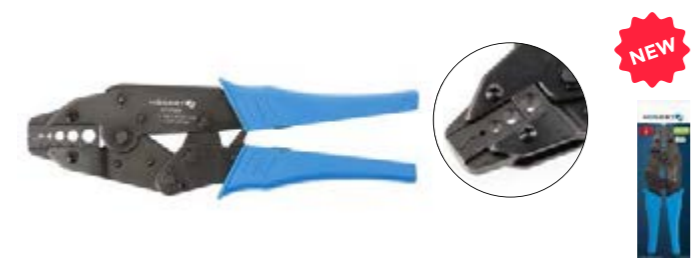

RATCHET	HT1P203	225 mm	1,0, 1,72, 2,0, 3,25, 3,84, 4,5	10	40
	HT1P204	230 mm	1,72, 2,6, 5,4, 6,5, 8,1	10	40

DE Crimpzange für unisolierte Kabelschuhe EN Non-insulated terminal crimping plier FR Pince à sertir non isolée ideale pour des travaux de telecommunications ES Tenaza crimpadora para terminales no aislados HR Klijesta za stezanje neizoliranih stezaljki HU Szigetetlen szemes saru prés RO Cleste de sertizat BG Клеци за кримпване на неизолирани кабелни обувки

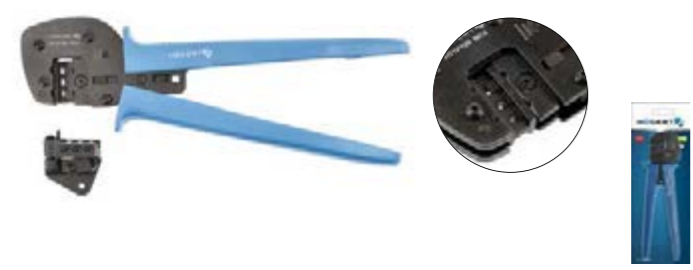

2,5/4,0/6,0 mm <sup>2</sup>	MC4	RATCHET	HT1P199	270 mm	2,5, 4,0 and 6,0 mm <sup>2</sup>	10	20
-----------------------------	-----	---------	---------	--------	----------------------------------	----	----

DE Hydraulische Kabelcrimper EN Hydraulic manual climping tool FR Sertisseuse hydraulique pour câbles ES Crimpadora hidráulica HR Hidraulična preša za kablove HU Hidraulikus kézi krimpelő eszköz RO Instrument de sertizare manual hidraulic BG Хидравлични клещи за кримпване на кабели



x12	100 kN	HT1P169	16-300 mm <sup>2</sup>	1	1
-----	--------	---------	------------------------	---	---

DE Crimpzange für KOAX-Kabelschuhe EN Coaxial connector terminal crimping pliers FR Pince à sertir coaxial ES Crimpadora cable coaxial HR Klijesta za stezanje stezaljki HU Koax csatlakozó prés RO Cleste de sertizat pentru conector coaxial BG Клеци за кримпване тип коак



HEX: 1/1.7/4.5/6.5/7 mm	RATCHET	HT1P196	230 mm	1, 1,7, 4,5, 6,5, 7 mm	10	40
-------------------------	---------	---------	--------	------------------------	----	----

DE Kompressionswerkzeug zum Verpressen EN Crimping pliers for connectors FR Pince à sertir coaxial ES Alicata para conectores HR Klijesta za stezanje koaksijalnih priključaka HU Présszerszám koaxiális csatlakozókhoz RO Cleste de sertizat pentru conector coaxial BG Клеци за кримпване конектори



A3 STEEL	BNC, F IEC, RCA	RG-59 RG-6 TriSet-113	ERGO GRIP	HT1P198	200 mm	RG-59, RG-6, TriSet-113 & TriSet Profi	10	40
----------	-----------------	-----------------------	-----------	---------	--------	--	----	----

DE Crimpzange für unisolierte Kabelschuhe EN Non-insulated terminal crimping plier FR Pince à sertir non isolée ideale pour des travaux de telecommunications ES Tenaza crimpadora para terminales no aislados HR Klijesta za stezanje neizoliranih stezaljki HU Szigetetlen szemes saru prés RO Cleste de sertizat BG Клеци за кримпване на неизолирани кабелни обувки



HEX 6/10/16 25/35/50 mm <sup>2</sup>	40 HRC	HT1P206	390 mm	6, 10, 16, 25, 35, 50 mm <sup>2</sup>	6 - 50 mm <sup>2</sup> (10 - 1 AWG)	1	10
--------------------------------------	--------	---------	--------	---------------------------------------	-------------------------------------	---	----

DE Crimpzange für Kabelbinder EN Cable tie crimping plier FR Outil de sertissage pour serre-câbles ES Herramienta de crimpado para bridas HR Alat za presovanje kabelskih vezica HU Karimás krimpelő szerszám RO Instrument de sertizare a flanșei BG Инструмент за кримпване на фланци



CRIMPING FORCE ADJUSTMENT	HT2C190	165 mm	2,4 - 4,8 mm	10	40
---------------------------	---------	--------	--------------	----	----

DE Isolierband EN Insulation tape FR Ruban isolant ES Cinta aislante HR Izolacijska traka HU PVC szigetelőszalag RO Benzi izolatoare BG Изолационна лента



0,13 x 19 mm	20 m	0,39 kV/mm	-20° +60°	125%	WATERPROOF	PVC	HT1P281	0,13 mm x 19 mm x 20 m	10	200
							HT1P282	0,13 mm x 19 mm x 20 m		
							HT1P283	0,13 mm x 19 mm x 20 m		
							HT1P284	0,13 mm x 19 mm x 20 m		
							HT1P285	0,13 mm x 19 mm x 20 m		
							HT1P286	0,13 mm x 19 mm x 20 m		

DE Kabeltrommel mit Gummi-Isolierung EN Rubber Insulated Drum Extension Cord FR Rallonge sur tambour en caoutchouc ES Enrollables con cable con aislamiento de goma HR Gumeni produžni kabel na bubnju HU Szigetelt gumiköpenyes hosszabbító kábeldob RO Prelungitor cu izolare din cauciuc cu tambur BG Удължител макара гумиран кабел

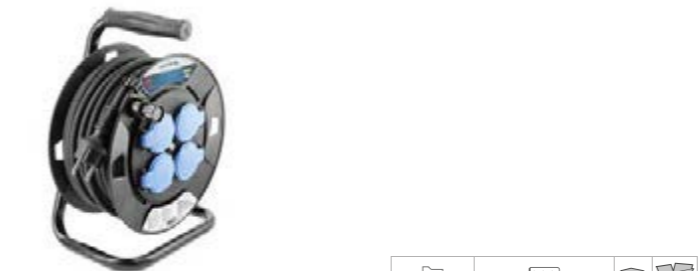

3x1,5 mm <sup>2</sup>	MAX 3000 W	H05RR-F	FRENCH	IP44	HT1E720	3 x 1,5 mm <sup>2</sup>	20 m	1	2
					HT1E721	3 x 1,5 mm <sup>2</sup>	30 m	1	2

DE Verlängerungskabel mit Gummi-Isolierung EN Rubber Insulated Extension Cord FR Rallonge électrique en caoutchouc ES Prolongador de cable con aislamiento de goma HR Produžni kabel u gumenoj izolaciji HU Rubber Insulated Extension Cord RO Rubber Insulated Extension Cord BG Гумиран удължител кабел



3x1,5 mm <sup>2</sup>	MAX 4000 W	H05RR-F	IP44	HT1E700	3 x 1,5 mm <sup>2</sup>	10 m	1	4
				HT1E701	3 x 1,5 mm <sup>2</sup>	20 m	1	1
				HT1E702	3 x 1,5 mm <sup>2</sup>	30 m	1	2

DE Kabeltrommel mit Gummi-Isolierung EN Rubber Insulated Drum Extension Cord FR Rallonge sur tambour en caoutchouc ES Enrollables con cable con aislamiento de goma HR Gumeni produžni kabel na bubnju HU Szigetelt gumiköpenyes hosszabbító kábeldob RO Prelungitor cu izolare din cauciuc cu tambur BG Удължител макара гумиран кабел



3x2,5 mm <sup>2</sup>	MAX 3600 W	H07RN-F	FRENCH	IP44	HT1E735	3 x 2,5 mm <sup>2</sup>	30 m	1	1
-----------------------	------------	---------	--------	------	---------	-------------------------	------	---	---



DE Werkzeuge Für Klempner

EN Tools For Plumbers

FR Outils Hydrauliques

ES Herramientas Para Fontaneros

HR Alati Za Vodoinstalatore

HU Gépészeti Szerszámok

RO Instrumente Pentru Instaltori

BG Инструменти За Водопроводчик

DE Wasserrohrzange EN Water pump pliers with spring release FR Pince pompe à eau à ressort ES Alicantes para tuberías HR Podesiva kliješta za cijevi HU Vízpumpa fogók RO Cleste tip paragal BG Клещи водопроводни тип "Гагра"



Folder	Length	Ø max	Weight	Box Qty
HT1P375	250 mm	38 mm	6	60
HT1P376	300 mm	50 mm	6	36
HT1P377	400 mm	95 mm	4	24



DE Wasserrohrzange, selbsteinstellend EN Auto adjusting water pump pliers FR Pince pompe à eau ajustement automatique ES Alicantes para tuberías autoajustables HR Samopodesiva kliješta za cijevi HU Auto adjusting water pump pliers RO Cleste tip paragal automat BG Клещи водопроводни тип "Гагра" с бутон



Folder	Length	Ø max	Weight	Box Qty
HT1P378	250 mm	35 mm	6	60
HT1P379	300 mm	40 mm	6	36



DE Wasserrohrzange EN Water pump pliers FR Pince pompe à eau ES Alicates HR Podesiva kliješta za cijevi HU Vízpumpa fogók RO Cleste tip paragal BG Клещи водопроводни



Folder	Length	Ø max	Weight	Box Qty
HT1P372	250 mm	35 mm	6	60



DE Gripzange EN Locking pliers FR Pince-étou avec mâchoires courbées ES Alicata de presión con mandíbulas curvadas HR Grip kliješta - okrugle čeljusti HU Rögzítő fogók - kerek pófával RO Cleste cu blocare - falci curbe BG Клещи чираци



Folder	Length	Weight	Box Qty
HT1P380	250 mm	6	36



DE Gripzange EN Locking pliers FR Pince-étou avec mâchoires droites ES Alicata de presión con mandíbulas rectas HR Grip kliješta - ravne čeljusti HU Rögzítő fogók - egyenes pófával RO Cleste cu blocare - falci drepte BG Клещи чираци



Folder	Length	Weight	Box Qty
HT1P382	250 mm	6	36



DE Gripzange EN Locking pliers FR Pince-étou avec mâchoires droites longues ES Alicata de presión con mandíbulas rectas largas HR Grip kliješta - izdužene, ravne čeljusti HU Rögzítő fogók - hosszú, egyenes pófával RO Cleste cu blocare - falci lungi, drepte BG Клещи чираци



Folder	Length	Weight	Box Qty
HT1P384	225 mm	6	36



DE Verstell Schlüssel EN Adjustable wrench FR Clé à molette Ergo Grip ES Llave ajustable Ergo Grip HR Podesivi ključ HU Állítható kulcs RO Chei reglabile BG Регулируем гаечен ключ



Folder	Length	Ø max	Weight	Box Qty
HT1P501	1" - 320 mm	50 mm	1	24
HT1P502	1-1/2" - 430 mm	70 mm	1	18
HT1P503	2" - 560 mm	80 mm	1	10



DE Verstell Schlüssel EN Adjustable wrench FR Clé à molette Ergo Grip ES Llave ajustable Ergo Grip HR Podesivi ključ HU Állítható kulcs RO Chei reglabile BG Регулируем гаечен ключ



Folder	Length	Ø max	Weight	Box Qty
HT1P506	1" - 320 mm	50 mm	1	24
HT1P507	1-1/2" - 430 mm	70 mm	1	18
HT1P508	2" - 560 mm	80 mm	1	10



DE Rohrschlüssel, Typ "S" EN Pipe wrenches, S-Type FR Clé à pipe type S ES Llave de tubo tipo S HR Ključ za cijevi, tip S HU Cső fogó - S típusú RO Cleste suedez tip S BG Тръбен ключ тип "Гагра"



Folder	Length	Ø max	Weight	Box Qty
HT1P519	0,5" - 240 mm	35 mm	1	48
HT1P520	1" - 320 mm	47 mm	1	24
HT1P522	1,5" - 430 mm	63 mm	1	18
HT1P524	2" - 560 mm	80 mm	1	10
HT1P526	3" - 640 mm	95 mm	1	6



DE Rohr zange EN Pipe wrench FR Clé serre-tube ES Llave de tubo HR Ključ za cijevi HU Cső fogó RO Cleste BG Тръбен ключ



Folder	Length	Ø max	Weight	Box Qty
HT1P531	10" - 250 mm	50 mm	6	48
HT1P533	12" - 300 mm	70 mm	6	36
HT1P535	14" - 350 mm	80 mm	6	24
HT1P537	18" - 450 mm	90 mm	6	12
HT1P539	24" - 600 mm	100 mm	5	10



DE Stillson Typ Rohr zange EN Pipe wrench (stillson type) FR Clé serre-tube Stillson ES Llave de tubo tipo Stillson HR Ključ za cijevi, tip stillson HU Cső fogó, „Stillson” típus RO Cleste tip „Stillton” BG Тръбен ключ



Folder	Length	Ø max	Weight	Box Qty
HT1P530	10" - 250 mm	34 mm	6	30
HT1P532	12" - 300 mm	42 mm	6	18
HT1P534	14" - 350 mm	50 mm	6	12
HT1P536	18" - 450 mm	60 mm	6	12



DE Rohrschlüssel EN Offset pipe wrench FR Clé à tube ES Llave de tubo HR Klijestima HU Hajlított csőkulcs RO Cheie curbată pentru țevi BG Тръбен ключ огънат



Folder	Length	Ø max	Weight	Box Qty
HT1P541	12" - 300 mm	70 mm	6	24
HT1P542	14" - 350 mm	80 mm	6	24
HT1P543	18" - 450 mm	90 mm	6	12



DE Rohrschlüssel EN Aluminium pipe wrench FR Clé à tube ES Llave de tubo HR Klijestima HU Alumínium csőkulcs RO Cheie din aluminiu pentru țevi BG Алюминиев тръбен ключ

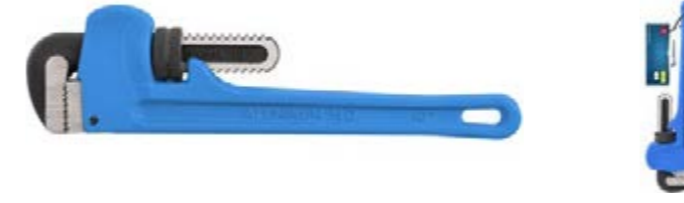

Folder	Length	Ø max	Weight	Box Qty
HT1P545	14" - 350 mm	80 mm	6	24
HT1P546	18" - 450 mm	90 mm	6	12
HT1P547	24" - 600 mm	100 mm	5	10



DE Kettenschlüssel EN Chain key FR Clé à chaîne ES Llave de cadena HR Lančani ključ HU Láncos cső fogó RO Cheie cu lant BG Верижен тръбен ключ



Folder	Length	Ø max	Weight	Box Qty
HT1P548	300 mm/12"	100 mm	6	24



DE Verstell Schlüssel EN Adjustable wrench FR Clé à molette Ergo Grip ES Llave ajustable Ergo Grip HR Podesivi ključ HU Állítható kulcs RO Chei reglabile BG Регулируем гаечен ключ



Folder	Length	Weight	Box Qty	
HT1P552	200 mm	25 mm	6	60
HT1P554	250 mm	30 mm	6	36
HT1P556	300 mm	36 mm	6	24



DE Verstell Schlüssel EN Adjustable wrench FR Clé à molette PRO Ergo Grip ES Llave ajustable Pro Ergo Grip HR Podesivi ključ HU Állítható kulcs RO Chei reglabile BG Регулируем гаечен ключ



Folder	Length	Weight	Box Qty	
HT1P560	250 mm	30 mm	6	36



DE Verstell Schlüssel EN Adjustable wrench FR Clé à molette ES Llave ajustable HR Oksidirani podesivi ključ HU Állítható oxidált kulcs RO Chei reglabile oxidate BG Регулируем гаечен ключ



**+25%**

CrV	LONG THIN JAW	SHORT HANDLE					
HT1P561	165 mm	35 mm	6	60			
HT1P563	215 mm	40 mm	6	60			

DE Verstell Schlüssel mit kurzem Griff EN Adjustable wrench FR Clé à ouverture variable à manche courte ES Llave ajustable con mango corto HR Podesivi ključ s kratkom ručicom HU Állítható kulcs rövid markolattal RO Chei reglabile cu maner scurt BG Регулируем гаечен ключ



**25 YEAR WARRANTY**

**+25%**

CrV	LONG THIN JAW	SHORT HANDLE					
HT1P562	140 mm	32 mm	6	72			

DE Verstell Schlüssel mit langem Griff EN Adjustable wrench FR Clé à molette à poignée longue ES Llave ajustable mango largo HR Podesivi ključ s dugom ručicom HU Állítható kulcs hosszú markolattal RO Chei reglabile cu maner lung BG Регулируем гаечен ключ



**25 YEAR WARRANTY**

**+25%**

CrV	LONG THIN JAW	30% ERGO GRIP					
HT1P564	256 mm	43 mm	6	36			

DE Stufenschlüssel EN Step wrench FR Clé de montage étagée ES Llave escalonada HR Koračni ključ HU Lépcsős radiátorkulcs RO Cheie în trepte BG Универсална ключ-вложка

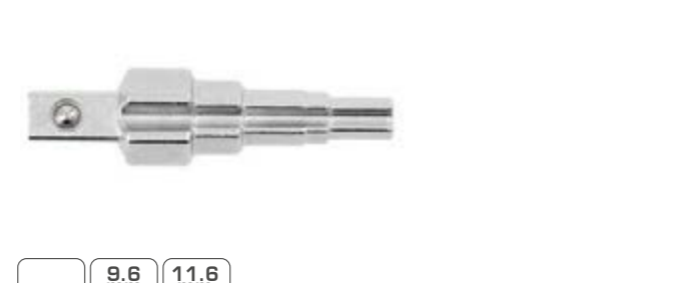

CrV	9,6 mm 3/8"	11,6 mm 29/68"					
12,6 mm 1/2"	16,4 mm 21/32"	21 mm 27/32"					
HT1P595	9.6 mm (3/8") - 21 mm (27/32")		1	100			

DE Rohrschneider EN Tube cutter FR Coupe-tube ES Cortatubos hasta HR Rezač cijevi HU Csővágó RO Cutter pentru tevi BG Тръборез



Cu, Al, Steel	HSS Ø 35mm	20-80 mm					
HT1P600	1/2"-2"	1	10				

DE Rohrschneider EN Tube cutter FR Coupe-tube ES Cortatubos HR Rezač cijevi HU Csővágó RO Cutter pentru tevi BG Тръборез



HRC 53	SK5	PVC	PP	PE			
PP-R	PEX	PEX-AL	QUICK BLADE CHANGE				
HT1P603	max. 42 mm		10	50			

DE Klinge für Rohrschneider HT1P603 EN Blade for pipe cutter HT1P603 FR Lame pour coupe-tube HT1P603 ES Cuchilla para cortatubos HT1P603 HR Oštrica za rezač cijevi HT1P603 HU Csővágó RO Cutter pentru tevi BG Режешц рѣб за трѣборез



HRC 53	SK5	V SHAPE	FOR HT1P603				
HT1P617	max 42 mm		20	200			

DE Rohrschneider EN Tube cutter FR Coupe-tube pour le plastique ES Corta-tubos de tubos de plástico HR Rezač cijevi HU Műanyag és gépészeti csővágó RO Cutter pentru tevi din plastic si conducte BG Тръборез



PL EN

HRC 53	230 mm	PVC	PP	PE			
PP-R	PEX	PEX-AL	V SHAPE				
HT1P605	42 mm		8	48			

DE Rohrschneider EN Tube cutter FR Coupe-tube ES Cortatubos hasta HR Rezač cijevi HU Csővágó 42 mm RO Cutter pentru tevi BG Тръборез



HRC 53	SK5	PVC	PP	PE			
PP-R	PEX	PEX-AL	V SHAPE	240 mm			
HT1P606	max. 42 mm		6	36			

DE Rohrschneider EN Tube cutter FR Coupe-tube pour l'aluminium et le cuivre ES Corta-tubos de tubos de aluminio y cobre HR Teleskopski rezač cijevi HU Alumínium és rézcső vágó RO Cutter pentru tevi din aluminiu si cupru BG Тръборез



6-35 mm	Al Cu						
HT1P612	6-35 mm		6	48			

DE Entgrater EN Reamer FR Ebavureur ES desbaradora para tubos HR Deburrer HU Cső sorjázó RO Debavur de tevi BG Шабър за отнемане на фаска външно и вътрешно



4-40 mm	Al Cu	PVC	PP				
HT1P620	4-40 mm		60	240			

DE Universal Bördelgerät EN Flaring nut set FR Presse à brider les câbles ES Prensa para embridado de cables HR Preša za rubljenje cijevi HU Cső toldó készlet RO Set de expansie de tevi BG Инструмент за валцоване на трѣби



Ø: 3, 5, 6, 8, 10, 12, 14, 15, 16, 19 mm

3-19 mm	90°	Al Cu					
HT1P626	3-19 mm		1	10			

DE Rohrschneider EN Tube cutter FR Coupe-tubes télescopique ES Cortatubos HR Teleskopski rezač cijevi HU Gyors beállítású csővágó RO Cutter pentru tevi cu actiune rapida BG Телескопичен трѣборез



Al Cu	GCR15	HRC 55-58					
HT1P611	3-32 mm		2	1	50		
HT1P614	14-63 mm		4	1	25		

DE Rohrschneider EN Tube cutter FR Coupe-tube ES Cortatubos hasta HR Rezač cijevi HU Csővágó RO Cutter pentru tevi BG Тръборез



Al Cu	GCR15	HRC 55-58					
HT1P623	15 mm		10	50			
HT1P624	18 mm		10	50			
HT1P625	22 mm		10	50			

DE Universal Bördelgerät EN Flaring nut set FR Presse à brider les câbles ES Prensa para embridado de cables HR Preša za rubljenje cijevi HU Cső toldó készlet RO Set de expansie de tevi BG Инструмент за валцоване на трѣби



Ø: 5, 6, 8, 10, 12, 16 mm

5-16 mm	90°	Al Cu					
HT1P627	5-16 mm		5	30			

DE Rohrbieger EN Pipe bender FR Cintreuse à tubes ES Dobladora de tubos HR Savijačica cijevi HU Kézi csőhajlító RO Indoitor manual de tevi BG Инструменти за огъване на трѣби



Al Cu	0-180°						
HT1P630	1/4", 5/16", 3/8" 6,3 mm, 8 mm, 10 mm		1	20			

DE Eine Presse zum Ausdehnen von Rohren EN Manual tube expander FR Une presse pour dilater les tuyaux ES Una prensa para expandir tuberías HR Preša za širenje cijevi HU Prés a csövek kibővítéséhez RO O presă pentru țevi în expansiune BG Инструмент за разширяване на медни тръби



AI Cu	HT1P628	6, 8, 10, 12, 16, 19, 22 mm 1/4", 5/16", 3/8", 1/2", 5/8", 3/4", 7/8"	10	20
-------	---------	--	----	----

DE Rohr Einfädler EN Manual pipe threader FR Filetuse à tuyau ES Enhebrador de tubos HR Nareznice za cijevi HU Cső menetvágó készlet RO Set de filetare tevi BG Разширителна глава за експандер за тръби



6 die sizes:  
1/4", 3/8", 1/2", 3/4", 1", 1 1/4"  
Ratchet  
Handle extension

STEEL	BSPT	9CR2	Ductile Iron	HT1P635	1/4"-5/4"	1	4
-------	------	------	--------------	---------	-----------	---	---

DE Rohr Einfädler EN Manual pipe threader FR Filetuse à tuyau ES Enhebrador de tubos HR Nareznice za cijevi HU Cső menetvágó készlet RO Set de filetare tevi BG Разширителна глава за експандер за тръби



6 die sizes:  
1/2", 3/4", 1", 1 1/4", 1 1/2", 2"  
Ratchet  
2 handle extensions

STEEL	BSPT	9CR2	Ductile Iron	HT1P636	1/2" - 2"	1	2
-------	------	------	--------------	---------	-----------	---	---

DE Gewindeschneidkopf EN Head for ratchet die stock FR Mandrin porte-taraud ES Cabeza de corte de rosca HR Glava za rezanje navoja HU Menetvágó fej RO Cap de filetat BG Разширителна глава за експандер



HT1P637	1/4"	1	20
HT1P638	3/8"	1	20
HT1P639	1/2"	1	20
HT1P640	3/4"	1	20
HT1P641	1"	1	20
HT1P642	5/4"	1	20
HT1P643	3/2"	1	8
HT1P644	2"	1	8

DE Crimpwerkzeug für PEX-Rohre EN Crimping tool for PEX pipes FR Sertisseuse pour raccords sur tubes PEX ES Engarzadora de conectores de tubería PEX HR Press kliješta za PEX cijevi HU Krimpelő eszköz PEX csövekhez RO Instrument de sertizare pentru țevi PEX BG Ръчна преса за PEX тръби



25 YEAR WARRANTY

PEX -AL -PEX	40 kN	580-760 mm	HT1P645	TH 16, TH20, TH26, TH32	1	1
--------------	-------	------------	---------	-------------------------	---	---

DE Crimpeinsatz EN Dies FR Matrices TH ES Matrices HR Nastavak HU Csatlakozó csőkrimpeléshez RO Matrice pentru aparat de sertizare a țevilor BG Матрица за ръчна преса



Type			
TH	TH 16 - 16 mm	1	1
	TH 20 - 20 mm	1	1
	TH 26 - 26 mm	1	1
	TH 32 - 32 mm	1	1
U	U 16 - 16 mm	1	1
	U 20 - 20 mm	1	1
	U 25 - 25 mm	1	1
	U 32 - 32 mm	1	1

DE Muffenscheißgerät EN Thermoplastic pipe welder FR Soudeur de tuyaux thermoplastiques ES Máquina de soldadura de para tuberías termoplásticas HR Zavarivač termoplastične cijevi HU Hegesztő berendezés termoplasztikus csövekhez RO Mașină de sudat pentru țevi termoplastice BG Заваряваща машина за термoplastични тръби



LCD	850 W	0-300°C	LOW TEMPERATURE PROTECTION	HT1P680	16, 20, 25, 32, 40, 50, 63 mm	1	2
-----	-------	---------	----------------------------	---------	-------------------------------	---	---

DE 3 in 1 Gaslötkolben EN 3 in 1 soldering tool FR Lampe à souder à gaz ES Soplete soldador a gas HR Lemilice s napajanjem na plin HU Gáz forrasztópáka RO Ciocan de lipit cu gaz BG Газов поялник 3в1



3 in 1	220 W	PIEZO	GAS	CAPACITY 7 ml	HT2C401	W	12	48
max 40 min	1300°C TORCH	550°C HOT AIR GUN	400°C SOLDERING IRON	PROPAN BUTAN				

DE Lötbrenner EN Gas blow torch FR Torche à gaz ES Soplete de gas HR Plinska let lampa HU Gázégő RO Arzator cu gaz BG Горелка



1,3 kW	PIEZO	GAS	PROPAN BUTAN	HT2C500	max. 1300°C	10	100
96 g/h							

DE Gasbrenner EN Gas burner FR Chalumeau à gaz ES Soplete de gas HR Plamenik turbo propan HU Propán gázégő RO Arzator cu gaz BG Горелка



360°	1,0 kW	BUTAN	PIEZO	GAS	HT2C505	1300°C	10	100

DE Turbo propan gas torch EN Turbo propan hand-brenner FR Bruleur à gaz ES Quemador de gas turbo HR Plamenik turbo propan HU Propán gázégő RO Arzator cu gaz BG Горелка



360°	3,3 kW	PROPAN	MAPP	TURBO	HT2C502	max. 2800°C	1	20
235 g/h		G1" F	G1" M					

DE Adapter for propan gas torch EN Adapter fur propan hand-brenner FR Adaptateur ES Adaptador HR Adapter za plamenike HU Égő adapter RO Arzator cu gaz BG Адаптер за котлон



G1" M x G7/16" F	G1" M	G7/16" M	for HT2C502 HT2C503	HT2C504	1	100
------------------	-------	----------	---------------------	---------	---	-----

DE Gaslotlampe EN Gas soldering lamp FR Torche à gaz ES Lampa de gas para soldar HR Plinska let lampa HU Gázforrasztó RO Lampa de lipit cu gaz BG Газова горелка



360°	1,7 kW	PIEZO	PROPAN BUTAN	HT2C501	max. 850°C	1	20
190 g		GAS					

DE Gasbrenner EN Gas burner FR Chalumeau à gaz ES Soplete de gas HR Plamenik turbo propan HU Propán gázégő RO Arzator cu gaz BG Горелка



360°	1,0 kW	PIEZO	BUTAN	GAS	LOCK	CAPACITY 15 ml	HT2C509	1300°C	10	60

DE Turbo propan gas torch EN Turbo propan hand-brenner FR Bruleur à gaz ES Quemador de gas turbo HR Plamenik turbo propan HU Propán gázégő RO Arzator cu gaz BG Горелка



360°	2,0 kW	PROPAN	MAPP	TURBO	PIEZO	G1" F	AUTO START/STOP	142 g/h	GAS	HT2C503	max. 2800°C	1	20

**HÖGERT**  
technik

DE Bauwerkzeuge  
EN Building Tools  
FR Outils De Construction  
ES Herramientas De Construcción  
HR Građevinski Alati  
HU Építőipari Szerszámok  
RO Unelte De Construcții  
BG Строителни Инструменти



DE Schlosserhammer EN Machinist hammer FR Marteau de mécanicien ES Martillo de mecánico HR Bravarski čekić HU Gépész kalapács RO Ciocan mecanic BG Шлосерски чук



Model	Weight	Head Width	Head Length	Head Height	Head Thickness
HT3B001	100 g	82 x 15 mm	260 mm	12	120
HT3B003	300 g	105 x 23 mm	300 mm	6	60
HT3B005	500 g	118 x 27 mm	320 mm	6	36
HT3B008	800 g	130 x 33 mm	350 mm	6	24
HT3B010	1000 g	135 x 36 mm	360 mm	6	12
HT3B015	1500 g	145 x 42 mm	380 mm	6	12
HT3B020	2000 g	155 x 42 mm	400 mm	6	12

C45  
DIN 1041  
DIN 1193  
HRC 52-58  
ERGO GRIP

DE Latthammer mit Glasfaserstiel EN Solid nail hammer FR Marteau de couvreur ES Martillo para clavos HR Stolarski čekić HU Ács kalapács RO Ciocan de cuie BG Чук за пирони



Model	Weight	Head Width	Head Length	Head Height	Head Thickness
HT3B030	600 g	170 x 27 mm	330 mm	6	24

C45  
DIN 7239  
HRC 50-58  
ERGO GRIP  
FIBERGLASS HANDLE

DE Monolithischer Maurerhammer EN Solid brick hammer FR Marteau de maçon monobloc ES Martillo de albañilería/ladrillo monobloque HR Zidarski čekić HU Bontó kalapács RO Ciocan de caramida solida BG Чук за тухли



Model	Weight	Head Width	Head Length	Head Height	Head Thickness
HT3B033	600 g	170 x 31 mm	315 mm	6	24

MONOLITH  
C45  
HRC 50-58  
ERGO GRIP

DE Monolithischer Tischlerhammer EN Carpenter's hammer FR Marteau de menuisier ES Martillo de carpintero HR Tesarski čekić HU Asztalos kalapács RO Ciocanul tamplarului BG Чук дърводелски



Model	Weight	Head Width	Head Length	Head Height	Head Thickness
HT3B035	450 g	132 x 31,5 mm	326 mm	6	24

MONOLITH  
C45  
HRC 50-58  
ERGO GRIP

DE Schlosserhammer EN Machinist hammer FR Marteau de mécanicien ES Martillo de mecánico HR Bravarski čekić HU Gépész kalapács RO Ciocan mecanic BG Чук шлосерски



Model	Weight	Head Width	Head Length	Head Height	Head Thickness
HT3B021	100 g	82 x 15 mm	260 mm	6	72
HT3B023	300 g	100 x 23 mm	278 mm	6	48
HT3B025	500 g	115 x 28 mm	290 mm	6	36
HT3B028	800 g	130 x 33 mm	350 mm	6	24
HT3B029	1000 g	135 x 36 mm	360 mm	6	12
HT3B038	1500 g	145 x 42 mm	380 mm	4	8
HT3B039	2000 g	155 x 47 mm	400 mm	4	8

C45  
HRC 50-58  
ERGO GRIP  
FIBERGLASS HANDLE

DE Monolithischer Latthammer EN Solid nail hammer FR Marteau de couvreur monobloc ES Martillo para clavos monobloque HR Stolarski čekić HU Bontó kalapács RO Ciocan de cuie BG Чук за пирони



Model	Weight	Head Width	Head Length	Head Height	Head Thickness
HT3B031	600 g	170 x 30 mm	330 mm	6	24

MONOLITH  
C45  
HRC 50-58  
ERGO GRIP

DE Tischlerhammer mit Glasfaserstiel EN Carpenter's hammer FR Marteau de charpentier ES Martillo de carpintero HR Tesarski čekić HU Asztalos kalapács RO Ciocanul tamplarului BG Чук дърводелски



Model	Weight	Head Width	Head Length	Head Height	Head Thickness
HT3B034	450 g	128 x 29 mm	285 mm	6	24

C45  
HRC 50-58  
ERGO GRIP  
FIBERGLASS HANDLE

DE Steinmetzhammer mit Glasfasergriff EN Stonemason's hammer FR Marteau taillant ES Martillo para piedra vidrio HR Zidarski čekić s drškom od stakloplastike HU Monolit kőműves kalapács RO Ciocan de tamplarie monolitica BG Зидарен чук



Model	Weight	Head Width	Head Length	Head Height	Head Thickness
HT3B036	1000 g	95 x 40 mm	260 mm	6	12

C45  
DIN 6475  
HRC 50-58  
ERGO GRIP



DE Gummihammer EN Rubber mallet FR Maillet en caoutchouc ES Martillo de goma negro HR Gumeni čekić HU Gumikalapács RO Ciocan de cauciuc BG Гумен чук



Folder	Weight	Head width	Head height	Head diameter	Head length
HT3B041	450 g	95 x 60 mm	320 mm	6	24
HT3B043	680 g	114 x 63 mm	334 mm	6	24
HT3B044	450 g	95 x 62 mm	275 mm	6	24
HT3B045	800 g	120 x 73 mm	350 mm	6	24
HT3B046	900 g	126 x 68 mm	743 mm	6	24

BLACK ERGO GRIP

DE Gummihammer EN Rubber mallet FR Maillet en caoutchouc ES Maza de goma HR Gumeni čekić HU Gumikalapács RO Ciocan de cauciuc BG Гумен чук



Folder	Weight	Head width	Head height	Head diameter	Head length
HT3B052	680 g	115 x 65 mm	305 mm	6	24

WHITE BLACK STREAKS FREE FIBERGLASS HANDLE ERGO GRIP

DE Äxte EN Axe FR Hache ES Hacha HR Sjekira HU Fejsze RO Topor BG Брадџа



Folder	Weight	Head width	Head height	Head diameter	Head length
HT3B070	600 g	148 x 105 mm	320 mm	6	24
HT3B071	800 g	165 x 115 mm	334 mm	6	12
HT3B072	1000 g	175 x 125 mm	334 mm	4	12
HT3B073	1250 g	190 x 135 mm	743 mm	4	8

HRC 47-55 DIN 5131 FIBERGLASS HANDLE ERGO GRIP

DE Hammer mit Glasfaserstiel Rückschlagfreier EN Dead blow hammer with fiberglass handle FR Maillet en plastique avec manche en fibre de verre ES Maza de plástico con mango de fibra de vidrio HR Čekić bez povratnog udara HU Erőlemezű kalapács RO Ciocan cu bile metalice interne BG Чук противооткатен



Folder	Weight	Head width	Head height	Head diameter	Head length
HT3B091	680 g	92 x 42 mm	248 mm	6	24

DEAD BLOW ERGO GRIP DEAD BLOW

DE Kunststoff Hammer EN Soft face hammer FR Maillet en caoutchouc ES Maza de goma HR Instalacijski čekić HU Puha gumikalapács RO Ciocan de cauciuc moale BG Инсталационен чук



Folder	Weight	Head width	Head height	Head diameter	Head length
HT3B048	32 mm	98 x 35 mm	255 mm	6	24

NO DAMAGE ERGO GRIP FIBERGLASS HANDLE

DE Äxte EN Axe FR Hache ES Hacha HR Sjekira HU Fejsze RO Topor BG Брадџа



Folder	Weight	Head width	Head height	Head diameter	Head length
HT3B060	600 g	145 x 105 mm	360 mm	6	24
HT3B062	800 g	165 x 115 mm	380 mm	6	12
HT3B064	1000 g	175 x 125 mm	400 mm	6	12
HT3B066	1200 g	190 x 135 mm	450 mm	4	8
HT3B069	2000 g	195 x 77 mm	700 mm	2	4

HRC 47-55 DIN 5131 ERGO GRIP HICKORY HANDLE WEDGE

DE Spaltaxt mit Glasfaserstiel EN Axe with handle FR Merlin avec manche en fibre de verre ES Hacha de rajar con empuñadura de fibra de vidrio HR Sjekira za cijepanje HU Hasító fejsze RO Topor despicat BG Брадџа клин



Folder	Weight	Head width	Head height	Head diameter	Head length
HT3B076	2000 g	185 x 77 mm	743 mm	2	4

HRC 47-55 FIBERGLASS HANDLE ERGO GRIP

DE Monolithischer Zimmermannshammer EN Monolithic carpentry hammer FR Marteau de menuisier monolithique ES Martillo de carpintería de una pieza HR Monolitni stolarski čekić HU Monolit asztalos kalapács RO Ciocan de tamplarie BG Чук кофражен монолитен



Folder	Weight	Head width	Head height	Head diameter	Head length
HT3B094	600 g	180 x 27 mm	365 mm	6	24

MONOLITH C45 DIN 7239 HRC 50-58 ERGO GRIP NAILS MAGNETIC HOLDER

DE Schlosserhammer EN Locksmith's hammer FR Marteau de mécanicien ES Martillo de mecánico HR Bravarski čekić HU Gépész kalapács RO Ciocan mecanic BG чук шлосерски



Folder	Weight	Head width	Head height	Head diameter	Head length
HT3B095	3000 g	160 x 57 mm	885 mm	2	4
HT3B097	5000 g	185 x 70 mm	905 mm	2	4

C45 FIBERGLASS HANDLE HRC 50-58 DIN 1041

DE Blechscherer, linksschneidend EN Tin snips, left cut FR Cisaille aviation coupe à gauche ES Cizalla o cortachapas tipo aviación corte a la izquierda HR Škare za lim HU Lemezvágó olló RO Foarfece pentru placi metalice BG Ножици за ламарина



Folder	Weight	Head width	Head height	Head diameter	Head length
HT3B501	250 mm	5	50		

CrMo DIN 6438 HRC 60-62 max 1.5 mm FOR AL FOR STEEL FOR STEEL MESH FOR PLASTIC

DE Gebogene Blechscherer, linksschneidend EN Offset tin snips, bent left FR Cisaille chantourneuse coupe gauche ES Tijeras cortachapa izquierdas HR Ukošene škare za lim HU Lemezvágó olló RO Foarfece pentru placi metalice BG Ножици за ламарина странични



Folder	Weight	Head width	Head height	Head diameter	Head length
HT3B504	250 mm	5	30		

CrMo 250 mm max 1.5 mm HRC 60-62 DIN 6438 FOR AL FOR STEEL FOR STEEL MESH FOR PLASTIC

DE Blechscherer, gerade EN Tin snips, straight cut FR Cisaille à tôle coupe droite ES Cizalla o cortachapas corte recto HR Škare za lim HU Lemezvágó olló RO Foarfece pentru placi metalice BG Ножици за ламарина



Folder	Weight	Head width	Head height	Head diameter	Head length
HT3B506	260 mm	6	36		

DIN 6438 HRC 55-60 max 1.0 mm FOR AL FOR STEEL MESH FOR PLASTIC

DE Blechscherer, gerade EN Tin snips, straight cut FR Cisaille aviation coupe droite ES Cizalla o cortachapas tipo aviación corte recto HR Škare za lim HU Lemezvágó olló RO Foarfece pentru placi metalice BG Ножици за ламарина



Folder	Weight	Head width	Head height	Head diameter	Head length
HT3B500	250 mm	5	50		

CrMo DIN 6438 HRC 60-62 max 1.5 mm FOR AL FOR STEEL MESH FOR STEEL FOR PLASTIC

DE Blechscherer, rechtsschneidend EN Tin snips, right cut FR Cisaille aviation coupe à droite ES Cizalla o cortachapas tipo aviación corte a la derecha HR Škare za lim HU Lemezvágó olló RO Foarfece pentru placi metalice BG Ножици за ламарина



Folder	Weight	Head width	Head height	Head diameter	Head length
HT3B502	250 mm	5	50		

CrMo DIN 6438 HRC 60-62 max 1.5 mm FOR AL FOR STEEL MESH FOR STEEL FOR PLASTIC

DE Gebogene Blechscherer, rechtsschneidend EN Offset tin snips, bent right FR Cisaille chantourneuse coupe droite ES Tijeras cortachapa derechas HR Ukošene škare za lim HU Lemezvágó olló RO Foarfece pentru placi metalice BG Ножици за ламарина странични



Folder	Weight	Head width	Head height	Head diameter	Head length
HT3B505	250 mm	5	30		

CrMo 250 mm max 1.5 mm HRC 60-62 DIN 6438 FOR AL FOR STEEL MESH FOR STEEL FOR PLASTIC

DE Blechscherer, linksschneidend EN Tin snips, left cut FR Cisaille à tôle coupe à gauche ES Tijeras para chapa, izquierdas HR Škare za lim, lijevo HU Fémlemez olló egyenes RO Foarfece pentru placi metalice BG Ножици за ламарина, лява



Folder	Weight	Head width	Head height	Head diameter	Head length
HT3B507	250 mm	6	36		

DIN 6438 HRC 55-60 FOR AL FOR STEEL MESH FOR PLASTIC



DE Blechschere, rechtsschneidend EN Tin snips, right cut FR Cisaille à tôle coupe à droite ES Tijeras para chapa, derechas HR Škare za lim, desno HU Fémlemez olló egyenes RO Foarfece pentru placi metalice BG Ножици за ламарина, дясна



DIN 6438	HRC 55-60						
HT3B508	250 mm	6	36				

DE Dachzange EN Flat pliers FR Pince à toit ES Tenazas de techo HR Krovne hvataljke HU Tetőfogók RO Clești de acoperiș BG Клещи тип "човки"



HRC 28-32	273 mm	60 mm					
HT3B510	0°	6	24				

DE Dachzange EN Flat pliers FR Pince à toit ES Tenazas de techo HR Krovne hvataljke HU Tetőfogók RO Clești de acoperiș BG Клещи тип "човки"



HRC 28-32	273 mm	60 mm					
HT3B512	90°	6	24				

DE Bolzenschneider EN Bolt cutter FR Cisailles à tiges ES Cortavarillas HR škare HU Csapszevágó RO Scule tăiere BG Ножици



HT3B523	5 mm	350 mm	1 30
HT3B524	6 mm	450 mm	1 20
HT3B525	8 mm	600 mm	1 10
HT3B526	10 mm	750 mm	1 5
HT3B527	12 mm	900 mm	1 5

CrMo HRC 57-62

DE Pelikan Blechschere EN Pelican Tin snips FR Cisaille à tôle pélican ES Cizalla pelicano para corte a izquierda y derecha HR Škare za lim HU Lemezvágó olló RO Foarfece pentru placi metalice BG Професионални ножици за изрязване



DIN 6438	HRC 55-60						
FOR AL	FOR STEEL MESH	FOR PLASTIC	max 1.0 mm	HT3B509	300 mm	6	24

DE Dachzange EN Flat pliers FR Pince à toit ES Tenazas de techo HR Krovne hvataljke HU Tetőfogók RO Clești de acoperiș BG Клещи тип "човки"



HRC 28-32	273 mm	60 mm					
HT3B511	45°	6	24				

DE Multifunktions-Schlitzwinkelschere EN Multi-function slot angle scissor FR Ciseaux d'angle de fente multifonctions ES Tijera de ángulo de ranura multifunción HR Višenamjenske kutne škare za utore HU Többfunkciós nyílászög olló RO Foarfecă unghiulară multifuncțională a slotului BG Ножица с многофункционален слот ъгъл



HT3B514	220 mm	8	32

DE Mini Bolzenschere EN Mini bolt cutter FR Mini coupe-boulon à poignée bimatière ES Mini cortador de pernos o cizalla con mango bimaterial HR Škare za rezanje žice HU Miní hidegvágó RO Cleste mini pentru taiat bolturi BG Ножици за тел



HT3B540	210 mm	6	36

Mn65 max ∅ 3.5mm

DE Hydraulikschneider EN Hydraulic cutter FR Coupe-barre hydraulique ES Cortador hidráulico HR Hidraulični rezač HU Hidraulikus vágó RO Freză hidraulică BG Хидравлична ножица



STEEL	80 kN	4 - 16 mm	410 mm	HRC 50-58				
HT3B548	4 - 16 mm	1	1					

DE Drahtbürste, vier Reihen, Draht aus Stahl EN Wire brush, steel wire FR Brosse métallique acier ES Cepillo metálico de acero HR Žičana četka HU Drótkéfe RO Perii de sarma BG Стоманена четка



STEEL	ABS	ERGO GRIP	4x16				
HT3B621	110 mm	250 mm	12	72			

DE Drahtbürste, vier Reihen, Draht aus Messing EN Wire brush, brass wire FR Brosse métallique laiton ES Cepillo metálico de latón HR Žičana četka HU Drótkéfe RO Perii de sarma BG Четка месинг



BRASS	ABS	ERGO GRIP	4x16				
HT3B623	110 mm	250 mm	12	72			

DE Surform EN Surform FR Rabot bloc surform ES Cepillo Surform HR Rašpa HU Reszelőgyalu RO Pila cu adaptor BG Ръчно ренде



STEEL	PVC				
HT3B641	42 mm	250 mm	6	60	

DE Drahtbürste, vier Reihen, Draht aus Stahl EN Wire brush, steel wire FR Brosse métallique acier ES Cepillo metálico de acero HR Žičana četka HU Drótkéfe RO Perii de sarma BG Стоманена четка



HT3B624	4x15	120 mm	290 mm	12	120
HT3B625	5x15	120 mm	290 mm	12	120
HT3B626	6x15	120 mm	290 mm	12	120

DE Drahtbürste, vier Reihen, Draht aus rostfreiem Stahl EN Wire brush, steel wire FR Brosse métallique acier inoxydable ES Cepillo metálico de acero inoxidable HR Žičana četka HU Drótkéfe RO Perii de sarma BG Стоманена четка



STAINLESS STEEL	ABS	ERGO GRIP	4x16				
HT3B622	110 mm	250 mm	12	72			

DE Surform EN Surform FR Rabot bloc surform ES Cepillo Surform HR Rašpa HU Reszelőgyalu RO Perii de sarma BG Ръчно ренде



STEEL	PVC				
HT3B640	42 mm	140 mm	6	60	

DE Glasschneider EN Glass cutter tool FR Coupe-verre ES Cortador de vidrio HR Rezač stakla HU Üvegvágó RO Taietor de sticlă BG Нож за стъкло



HT3B670	130 mm	6	240

x6 CARBIDE WOODEN HANDLE GLASS ERGO GRIP

DE Meißel mit Schlaghandschutz EN Cold chisel with guard FR Burin plat avec protection Ergo Grip ES Cincel plano con protección HR Ravni rezač s poklopcem HU Lapos fejtű véső kézvédővel RO Dalta lata BG Секач ударен



CrV	TPE	ERGO GRIP				
HT3B700	19 mm	255 mm	10	20		

DE Werkzeugset – Körner, Meißel EN Chisel and punch set FR Pack de ciseaux et chasse-goupilles ES Paquete de tijeras y punzones HR Komplet rezača, točkala i izbijača HU Véső és lyukasztó készlet RO Set de dalti si punctatoare BG Център автоматичен за маркиране



CrV	x6					
HT3B710	10 x 142 mm, 10 x 152 mm 2 x 140 mm, 3 x 152 mm 6 x 152 mm, 8 x 115 mm	6	36			

DE Werkzeug-Set Körner Meißel Splinttreiber EN Chisel and punch set FR Jeu de poinçons et ciseaux ES Cinceles y cortafíos HR Komplet rezača, točkala i izbijača HU Véső és lyukasztó készlet RO Set de dalti si punctatoare BG Ударни дорници и секачи



CrV	x5	55-60 HRC	STRONG			
HT3B713	12 x 9,5 x 130 mm 5 x 9,5 x 130 mm 4 x 9,5 x 150 mm 3,5 x 9,5 x 120 mm 4 x 9,5 x 120 mm	10	40			

DE Durchtreiber EN Pin punch FR Poinçon ES Cincel HR Bravarski izbijač HU Gépész lyukasztó RO Punctator mecanic BG Дорник ударен



CrV	55-60 HRC	STRONG				
HT3B724	3 x 8 x 152 mm	25	200			
HT3B725	4 x 8 x 152 mm	25	200			
HT3B726	5 x 8 x 152 mm	25	200			
HT3B727	6 x 10 x 152 mm	25	200			

DE Spitzmeißel mit Handschutz EN Concrete chisel with hand guard FR Burin en pointe avec protection ES Cincel en punta para hormigón con protección HR Probijač s poklopcem HU Hegyes fejtű véső kézvédővel RO Dalta ascutita BG Шило ударно



CrV	TPE	ERGO GRIP				
HT3B708	4 mm	16 mm	255 mm	10	20	

DE Werkzeugset – Körner, Meißel EN Chisel and punch set FR Pack de ciseaux et chasse-goupilles ES Paquete de tijeras y punzones HR Komplet rezača, točkala i izbijača HU Véső és lyukasztó készlet RO Set de dalti si punctatoare BG Център автоматичен за маркиране



CrV	x12					
HT3B712	10 x 140 mm, 12 x 150 mm, 16 x 170 mm 1,5 x 150 mm, 3 x 150 mm, 4 x 150 mm, 5 x 150 mm, 6 x 150 mm, 8 x 150 mm 2 x 140 mm, 6 x 100 mm, 8 x 115 mm	6	12			

DE Flachmeißel EN Cold chisel FR Poinçon ES Cortafíos HR Bravarski rezač HU Gépész lapos véső RO Dalta mecanica BG Секач ударен



CrV	55-60 HRC	STRONG				
HT3B721	10 x 8 x 142 mm	25	200			
HT3B722	13 x 10 x 150 mm	25	200			
HT3B723	16 x 13 x 150 mm	25	200			

DE Körner EN Center punch FR Pointeau ES Granete HR Bravarsko točkalo HU Gépész pontozó RO Punctator mecanic BG Център автоматичен за маркиране



CrV	55-60 HRC	STRONG				
HT3B728	6 x 10 x 102 mm	25	200			
HT3B729	8 x 11 x 115 mm	25	200			

DE Feile für Metall EN Flat metal file FR Lime plate à métaux ES Lima plana metálica Ergo Grip HR Ravna turpija za metal HU Lapos fémreszelő RO Pila dreptunghiulara pentru metal BG Пила плоска за метал



T12 STEEL	ERGO GRIP	#2	200 mm			
FOR STEEL	FOR PLASTIC	FLAT CONVERTIBLE	HT3B800	200 mm	10	60

DE Rundfeile für Metall EN Round metal file FR Lime ronde à métaux ES Lima redonda metálica Ergo Grip HR Okrugla turpija za metal HU Kerek fémreszelő RO Pila rotunda pentru metal BG Пила за метал кръгла



T12 STEEL	ERGO GRIP	#2	200 mm				
FOR STEEL	FOR PLASTIC	Ø8 mm	CIRCLE	HT3B802	200 mm	10	60

DE Diamant-Nadelfeile EN Diamond needle file FR Fichiers d'aiguille diamant ES Conjunto de limas de aguja de diamante HR Dijamantne igličaste turpije HU Gyémánt tűreszelő készlet RO Set de pile diamantate pentru metal BG Комплект диамантени пили игли



A3 STEEL	ERGO GRIP	50 mm	Ø3 mm	CIRCLE				
TRIANGLE	SQUARE	SEMICIRCLE	FLAT	HT3B808	3 mm	140 mm	12	240

DE Holzraspel EN Flat wood rasp FR Lime plate à bois ES Lima plana para madera Ergo Grip HR Ravna turpija za grubu obradu drva HU Lapos fareszelő RO Pila dreptunghiulara pentru lemn BG Пила плоска за дърво



ERGO GRIP	200 mm	FLAT	HT3B810	200 mm	10	60
-----------	--------	------	---------	--------	----	----

DE Halbrundfeile für Metall EN Half-round metal file FR Lime demi-ronde à métaux ES Lima semi-redonda metálica Ergo Grip HR Poluokrugla turpija za metal HU Fél-kerek fémreszelő RO Pila semirotunda pentru metal BG Пила за метал полукръгла



T12 STEEL	ERGO GRIP	#2	200 mm			
FOR STEEL	FOR PLASTIC	SEMICIRCLE	HT3B801	200 mm	10	60

DE Dreiecksfeile für Metall EN Triangular metal file FR Lime triangulaire à métaux ES Lima triangular metálica Ergo Grip HR Trokutasta turpija za metal HU Háromszög alakú fémreszelő RO Pila triunghiulara pentru metal BG Триъгълна метална пила



T12 STEEL	ERGO GRIP	#2	200 mm			
FOR STEEL	FOR PLASTIC	TRIANGLE	HT3B804	200 mm	10	60

DE Diamant-Nadelfeile EN Diamond needle file FR Fichiers d'aiguille diamant ES Conjunto de limas de aguja de diamante HR Dijamantne igličaste turpije HU Gyémánt tűreszelő készlet RO Set de pile diamantate pentru metal BG Комплект диамантени пили игли



x10	GCR15 STEEL	ERGO GRIP	CIRCLE	TRIANGLE					
SQUARE	SEMICIRCLE	FLAT	FLAT CONVERTIBLE	OVAL	HT3B809	3 mm	140 mm	12	120

DE Holzraspel, halbrund EN Half-round wood rasp FR Lime demi-ronde à bois ES Lima semi-redonda para madera HR Poluokrugla turpija za grubu obradu drva HU Fél-kerek fareszelő RO Pila semirotunda pentru lemn BG Пила полукръгла за дърво



ERGO GRIP	200 mm	SEMICIRCLE	HT3B811	200 mm	10	60
-----------	--------	------------	---------	--------	----	----

DE Holzflachmeißel EN Chisel FR Ciseau à bois avec manche en bois ES Cincel con mango de madera HR Ravno dljeto HU Lapos favésó RO Dalti pentru lemn BG Длето дърводелско



Folder	Length	Width	Box
HT3B841	8 mm	6	36
HT3B842	10 mm	6	36
HT3B843	12 mm	6	36
HT3B845	16 mm	6	36
HT3B848	20 mm	6	36
HT3B850	25 mm	6	36
HT3B852	32 mm	6	36

CrV DIN 5139 WOODEN HANDLE ERGO GRIP 140 mm

DE Beißzange EN Carpenter's pincers FR Tenaille russe ES Tenaza de carpintero HR Klješta za čavle HU Asztalos csírófogó RO Cleste pentru cuie BG Клеци за пирони



Folder	Length	Width	Box
HT1P350	180 mm	6	60

CrV HRC 58-62 ERGO GRIP

DE Profilverbundzange EN Pliers for connecting profiles FR Pincés à lier pour profilés ES Alicates para conectar perfiles HR Klješta za spajanje profila HU Profilrögzítő fogó RO Cleste pentru conectarea profilelor BG Кримпващи клещи



Folder	Length	Width	Box
HT1P390	275 mm	6	24

GR15 STEEL max 0.5-0.8 mm 275 mm

DE Zange zum Verformen von Profilen, gerade EN Profile shaping pliers, straight FR Pincés à profilés, simples ES Alicates de perfil, rectos HR Klješta za oblikovanje profila, ravna HU Profilformázó fogó, egyenes fejtű RO Cleste pentru modelare a profilelor, drept BG Кримпващи клещи, прави



Folder	Length	Width	Box
HT1P393	210 mm	2	12
HT1P394	210 mm	2	12

210 mm 80x35 mm 150x35 mm

DE Brecheisen EN Crowbars FR Pied de biche avec corps hexagonal ES Palanca HR Građevinska poluga HU Feszítóvasak RO Rangi BG Цанга тип кози крак



HEXAGONAL FORGED

Folder	Length	Width	Box
HT3B880	16 x 450 mm	1	12
HT3B881	18 x 600 mm	1	12
HT3B882	19 x 750 mm	1	10

DE Kneifzange EN Rabbit pincers FR Pince coupante devant ES Tenaza rusa HR Klješta za malterisanje HU Kisfejtű csírófogó RO Cleste pentru dulgheri BG Клеци керпеден



Folder	Length	Width	Box
HT1P356	250 mm	6	36
HT1P358	300 mm	6	36

CrV HRC 58-62 ERGO GRIP

DE Zange zum Verformen von Profilen, abgebogen EN Profile shaping pliers, curved FR Pincés à cintrer des profilés courbés ES Alicates de perfil, curva HR Klješta za oblikovanje profila, savijena HU Profilformázó fogó, hajlított fejtű RO Cleste pentru modelare a profilelor, curbat BG Кримпващи клещи, извити

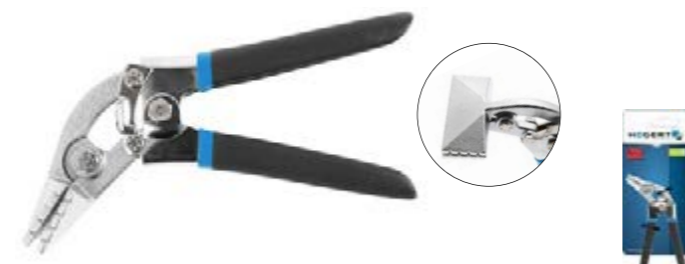

Folder	Length	Width	Box
HT1P392	210 mm	2	12

210 mm 80x35 mm

DE Schraubenzwinge EN F-clamp FR Serre-joint ES Abrazadera HR Stolarska stega HU Szorító RO Clema tip F BG Стяга дърводелска



Folder	Length	Width	Box
HT3B902	15050 mm	1	50
HT3B904	250 x 50 mm	1	50
HT3B906	300 x 80 mm	1	30
HT3B908	300 x 120 mm	1	20
HT3B909	500 x 120 mm	1	10
HT3B910	800 x 120 mm	1	6
HT3B920	1000 x 120 mm	1	6
HT3B921	1200 x 120 mm	1	6
HT3B922	1500 x 120 mm	1	6

DIN 5117 STEEL



DE Tischler Schraubzwingen, geschmiedet EN Steel forged F-clamp FR Serre-joint menuisier forgé ES Sargenta forjada HR Kovana stolarska stega HU Kovácsolt szorító RO Clema tip F forjat BG Стоманена винтова стяга



Code	Length	Width	Height	Weight	Volume
HT3B911	160 x 80 mm	10	30		
HT3B912	200 x 80 mm	10	30		
HT3B913	250 x 80 mm	10	30		
HT3B914	300 x 80 mm	10	30		
HT3B915	450 x 80 mm	10	20		
HT3B916	400 x 120 mm	1	10		
HT3B917	500 x 120 mm	1	10		
HT3B918	600 x 120 mm	1	10		

FORGED STEEL

DE Hebelzwinde EN Lever clamp FR Serre-joints ES Mordaza de palanca HR Stezaljka poluge HU Karos pillanatszorító RO Clema levier BG Лостова стяга



Code	Length	Width	Height	Weight	Volume
HT3B941	160 x 60 mm	6	24		
HT3B942	200 x 60 mm	6	24		
HT3B943	300 x 60 mm	6	24		

FORGED STEEL FIT FOR GUIDE RAILS

DE Schnellspannzwinde, Einhandzwinde EN Ratchet bar clamp and spreader FR Serre-joint à libération rapide ES Abrazadera de trinquete de liberación rápida HR Stolarska stega za brzo stezanje HU Racsnis szorító és tágitó RO Clema cu clichet pentru strangere si extensie BG Дърводелска стяга с тресчотков механизъм



Code	A	B	C	D	Weight	Volume
HT3B935	100	34	73	183	12	120
HT3B936	150	63	146	360	6	24
HT3B937	300	63	146	510	6	24
HT3B938	450	63	146	660	6	12
HT3B939	600	63	146	810	6	12
HT3B940	900	63	146	1110	6	12

PA6 TPR STEEL BAR

DE Federzwingen EN Spring clamp FR Pince de serrage ES Abrazadera con resorte HR Opružna stega HU Szorító csipesz RO Clema cu arc BG Ръчна пружинна стяга



Code	Length	Width	Height	Weight	Volume
HT3B944	110 mm	12	72		

x2 PE DURABLE SPRING max 38 mm

DE Federzwingen EN Spring clamp FR Pince de serrage ES Abrazadera con resorte HR Opružna stega HU Szorító csipesz RO Clema cu arc BG Ръчна пружинна стяга



Code	Length	Width	Height	Weight	Volume
HT3B946	165 mm	20	120		

PE DURABLE SPRING max 60 mm

DE Ratschenspannzwinde EN Ratchet-lock spring clamp FR Pince de serrage avec blocage ES Abrazadera con resorte y trinquete HR Preklopna stega HU Racsnis szorító csipesz RO Clema cu clichet si arc BG Ръчна стяга с тресчотков механизъм



Code	Length	Width	Height	Weight	Volume
HT3B952	150 mm	35 mm	12	96	
HT3B954	200 mm	45 mm	12	48	

PE

DE Winkelschraubstock EN Angle clamp FR Presse d'angle pivotante ES Prensa angular HR Kutna stega HU Derékszög szorító RO Clema pentru colturi BG Ърнова стяга



Code	Length	Width	Height	Weight	Volume
HT3B960	75 mm	1	20		

Aluminum 90° 75 mm 65 mm

DE Bandzwinde EN Clamp corner band strap FR Coin rapide de la bande de serrage sangle ES Prensa angular de cinta HR Tračna kutna stega HU Szalagos sarok szorító RO Clema pentru patru colturi cu banda BG Лентова стяга



Code	Length	Width	Height	Weight	Volume
HT3B963	4 m	1	20		

NYLON PVC NYLON 4 m x4

DE Fuchsschwanzsäge EN Hand saw FR Scie égoïne avec poignée ergonomique ES Sierra de mano con asa ergonómica HR Pila „Lisičji rep“ HU Rókfarkú fűrész RO Fierastrau pentru lemn BG Трион ръчен



Code	Length	Width	Height	Weight	Volume
HT3S202	400 mm	10	60		
HT3S204	450 mm	10	40		
HT3S206	500 mm	10	40		

FAST CUT 1:20 CUT HOOK 7 TPI HRC 44-46 ERGO GRIP

DE Handsäg EN Hand saw FR Scie à main ES Sierra de mano HR Ručna pila HU Kézifűrész RO Ferăstrău manual BG Ръчен трион



Code	Length	Width	Height	Weight	Volume
HT3S203	400 mm	12	48		
HT3S205	450 mm	12	48		
HT3S207	500 mm	12	48		

FAST CUT 1:20 CUT 7 TPI ERGO GRIP HRC 48-50 65 Mn

DE Rückensäge EN Back saw FR Scie à dos avec poignée ergonomique ES Sierra o serrucho de costilla con asa ergonómica HR Pila s ojačanim lednim dijelom HU Illesztő fűrész RO Fierastrau pentru lemn dreptunghiular BG Трион пасвател



Code	Length	Width	Height	Weight	Volume
HT3S232	350 mm	10	40		

350 mm FAST CUT 1:20 CUT 11 TPI HRC 44-46 ERGO GRIP

DE Kompass-Säge EN Compass saw FR Boussole scie ES Hoja de sierra con mango HR Ubodna pila HU Nyeles ágfűrész RO Fierastrau subtire de mana BG Трион кръгов



Code	Length	Width	Height	Weight	Volume
HT3S234	300 mm	10	60		

HRC 44-46 300 mm 9 TPI ERGO GRIP

DE Säge für GK-Platten EN Jab saw FR Scie à guichet ES Sierra de hender o serrucho HR Pila za gips-kartonske ploče HU Gipszkarton fűrész RO Fierastrau pentru decupat gips-carton BG Трион за гипскартон



Code	Length	Width	Height	Weight	Volume
HT3S238	150 mm	10	60		

HRC 44-46 150 mm 1:20 CUT 7 TPI ERGO GRIP

DE Schaubetonsäge EN Cellular concrete saw FR Scie à béton cellulaire ES Rakuline betoonsaag HR Stanična betonska pila HU Celluláris betonfűrész RO Ferăstrău celular din beton BG Клетъчен бетонен трион



Code	Length	Width	Height	Weight	Volume
HT3S239	600 mm	17 T	6	12	
HT3S240	600 mm	34 T	6	12	

65 Mn WOODEN GRIP HRA 90.7 TCT

DE Hacksaw for metal EN Hacksaw FR Sierra de arco para metales ES Sierra de arco para metales HR Pila za metal HU Keretes fűrész RO Fierastrau pentru metal BG Ръчна ножовка



Code	Length	Width	Height	Weight	Volume
HT3S270	300 mm	6	24		

HRC 42-44 AI 24 TPI ERGO GRIP

DE Mini hacksaw frame with blade, hacksaw for metal EN Mini hacksaw FR Sierra para metales ES Sierra para metales HR Drška s listom pile HU Mini fémfűrész RO Fierastrau mini pentru metal BG Ръчна ножовка олекотена



Code	Length	Width	Height	Weight	Volume
HT3S274-D	300 mm	12	48		

HRC 58-60 LIGHT TPR 24 TPI ERGO GRIP

DE Bow saw, universal EN Universal bow saw FR Sierra universal ES Sierra universal HR Univerzalna lučna pila HU Univerzális keretes fűrész RO Fierastrău universal cu gama BG Универсален трион-лък



TPR HANDLE  
10TPI  
18TPI  
24TPI  
METAL x2 WOOD x1  
STEEL  
45°&90°

HT3S277	300 mm	1	12
---------	--------	---	----

DE Sägeblätter für Metall EN Hacksaw blades FR Lames de scie à métaux ES Hoja de sierra para metales HR List pile za metal HU Fűrészlapok fémhez RO Lame pentru bomfaiere BG Лист за ножовка



HRC 58-64  
BiMetal  
x2  
BiMetal M2+6150  
24TPI

HT3S280	300 x 12,5 mm	24	144
---------	---------------	----	-----



300 mm  
18TPI  
24TPI  
BiMetal  
8% COBALT  
x2  
BiMetal M2+6150  
58-64 HRC

HT3S285	300 x 12,7 mm	18	40	400
HT3S286	300 x 12,7 mm	24	40	400

DE Rückensäge mit Gehrungskasten EN Back saw with mitre box FR Scie arrière avec boîte à mitres ES Sierra trasera con caja de inglete HR Stražnja pila s mitre kutijom HU Hátsó fűrész gérvágó dobozzal RO Ferăstrău spate cu cutie mitre BG Обратен трион с митре кутия



ABS  
45,90, 135°

HT3S296	300 mm	9 TPI	6	12
---------	--------	-------	---	----

DE Maurerbleistift EN Masonry pencil FR Crayon de maçon ES Lápiz de albañil HR Zidarska olovka HU Kőműves ceruza RO Creioane pentru zidari BG Молив за каменоделски



4H  
CONCRETE  
BRICK  
x 48

HT3B772	250 mm	1	960
---------	--------	---	-----

DE Gehrungslade EN Mitre box FR Boîte à onglets ES Caja de ingletes HR Mitra kutija HU Gérvágó láda RO Taietor de mitra BG Пластмасов шаблон за трион пасвател



ABS  
45,90, 135°  
10mm

HT3S295	300 x 140 x 80 mm	1	24
---------	-------------------	---	----

DE Tischlerbleistift EN Carpenter's pencil FR Crayon de charpentier ES Lápiz de carpintero HR Carpenterova olovka HU Ácsceruza RO Creioane pentru tamplari BG Молив дърводелски



HB  
WOOD  
x 48

HT3B770	250 mm	1	960
---------	--------	---	-----

DE Bleistift, Glasfläche EN Pencil for glass FR Crayon de verre ES Lápiz para vidrio HR Staklarska olovka HU Ceruza üveghez RO Creion pentru sticlă BG Молив за стъкло



R  
GLASS  
x 48

HT3B771	250 mm	1	960
---------	--------	---	-----



DE Kartuschenpresse bis EN Caulking gun FR Pistolet à calfeutrer, pour tubes et cartouches ES Pistola de masilla para tubos y cartuchos HR Pištolji za kartuše plastične mase HU Kinyomó pisztoly RO Presa cartuse tip salam BG Пистолет за картуш



	300 ml				
HT4R405	225 mm	1	20		

DE Montageschaumpistole EN Foam gun FR Pistolet à mousse ES Pistola de aluminio para espuma HR Pištolj za montažnu pjenu HU Purhab kinyomó RO Presa cartuse cu spuma BG Пистолет за монтажна пена



HT4R422	340 mm	200 mm	1	20				

DE Montageschaumpistole EN Foam gun FR Pistolet à mousse ES Pistola de aluminio para espuma HR Pištolj za montažnu pjenu HU Purhab kinyomó RO Presa cartuse cu spuma BG Пистолет за монтажна пена



HT4R425	320 mm	195 mm	1	20			

DE Schlüssel für Verteilerschränke EN Switch cabinet key FR Cle croix commutateur avec accessoires ES Llave de cruz universal para montar armarios HR Ključ za razvodne ormare HU Elosztódoboz kulcs RO Cheie pentru cutia de protectie BG Универсален ключ за шкафове



Zn	STEEL						
				HT1W760	76 mm	20	200

DE Schlüssel für Verteilerschränke EN Switch cabinet key FR Cle croix commutateur avec accessoires ES Llave de cruz universal para montar armarios HR Ključ za razvodne ormare HU Elosztódoboz kulcs RO Cheie pentru cutia de protectie BG Универсален ключ за шкафове



Zn	STEEL						
				HT1W761	85 mm	20	200

DE Verlängerungsstützstange EN Extension support rod FR Tige de support d'extension ES Varilla de soporte de extensión HR Potporna šipka za proširenje HU Hosszabbító tartórúd RO Tijă de susținere a extensiei BG Прът за поддръжка на разширението



HT3B680	60-115 cm	1	6	
HT3B681	125-290 cm	1	6	

DE Maurerschnur EN Masonry line FR Ligne de maçonnerie ES Línea de albañilería HR Zidana linija HU Falazat vonal RO Linia zidăriei BG Зидарна линия



HT4B310	100 m	25	100	

DE Maurerschnur EN Masonry line FR Ligne de maçonnerie ES Línea de albañilería HR Zidana linija HU Falazat vonal RO Linia zidăriei BG Зидарна линия



HT4B311	100 m	16	64	
HT4B312	50 m	32	128	

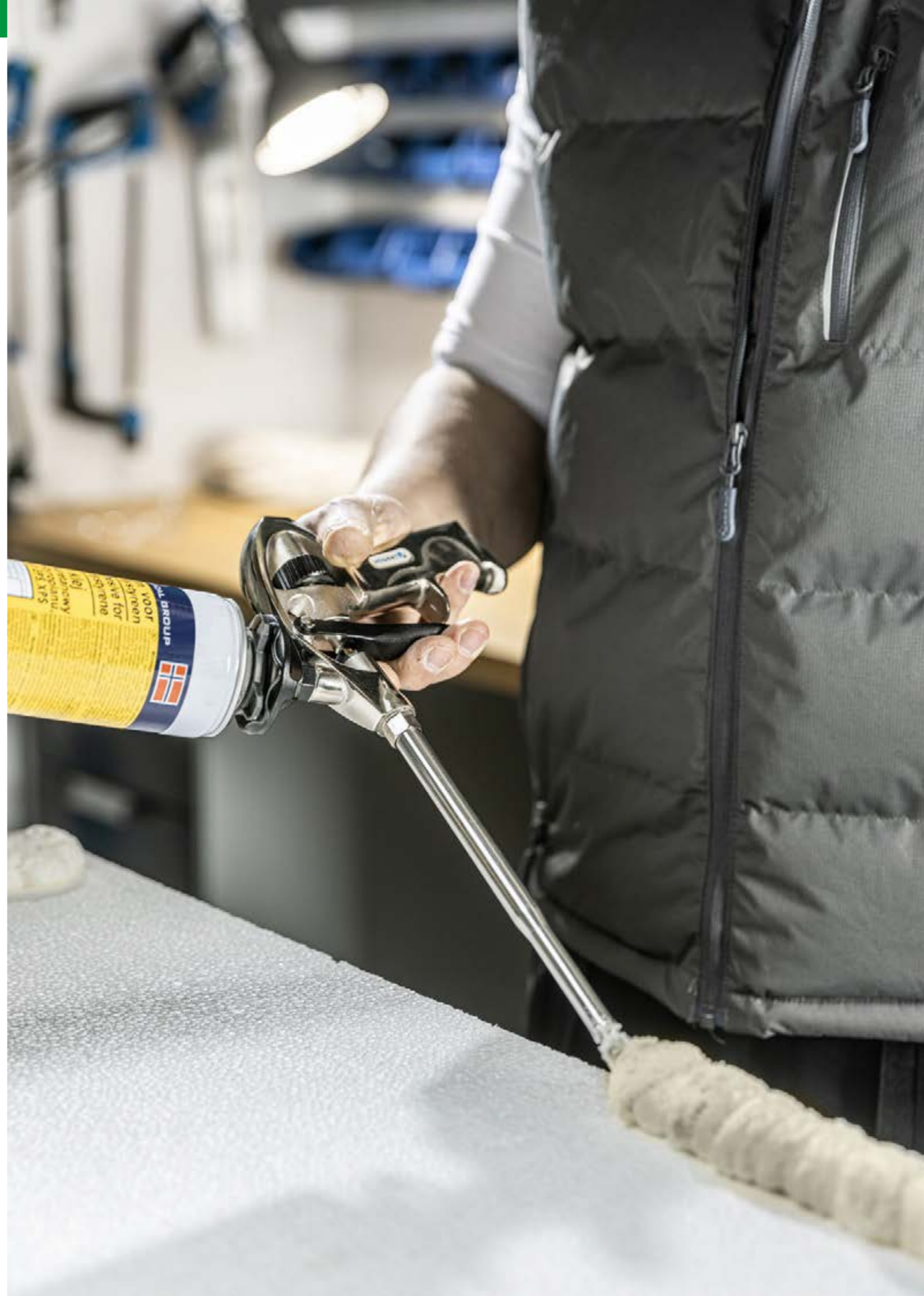

DE Permanentmarker EN Permanent marker FR Surligneur permanent ES Marcador permanente HR Stalni marker HU Alkoholos jelölő filc RO Marker permanent BG Перманентен маркер



QUICK DRYING NOT SMUDGING x 80

HT3B774	95 mm	2	6
---------	-------	---	---

DE Profilmuster EN Profile gauge FR Modèle de profil ES Plantilla de perfil HR Predložak profila HU Profilsablon RO Șablon de profil BG Шаблон за копиране на профили



WIDTH 275mm DEPTH 45mm MAGNETIC

HT4M218	275 mm	10	40
---------	--------	----	----

DE Magnet werkstückhalter EN Magnetic welding holder FR Support de soudage magnétique ES Soporte de Soldadura magnética HR Magnetni kutnik za varenje, strijela, heksagon HU Hatszögű mágneses hegesztő adapter RO Adaptor hexagonal magnetic de sudura BG Магнитен позиционер за заваряване



MAGNETIC 30° 45° 60° 75° 90° 135°

HT3B655	34 kg	8	16
HT3B656	22,5 kg	6	24
HT3B657	11,5 kg	6	48

DE Magnet werkstückhalter Satz EN Magnetic welding holder FR Support de soudage magnétique ES Soporte de Soldadura magnética HR Magnetski kutnik za varenje L-tipa HU L alakú mágneses hegesztő adapter RO Adaptor in forma de L magnetic de sudura BG Магнитен позиционер за заваряване



MAGNETIC x2 60° 90° 120°

HT3B665	9 kg	6	24
---------	------	---	----

DE Technische Kreide EN Technical chalk FR Craie industrielle ES Tiza técnica HR Tehnička kreda HU Műszaki kréta RO Creta tehnica BG Техническа креда



TEFLON GRANITE STEEL WOOD TEXTILES GLASS x12

HT3B775	120 mm	1	50
HT3B776	120 mm	1	50
HT3B777	120 mm	1	50
HT3B778	120 mm	1	50

DE Magnet werkstückhalter EN Magnetic welding holder FR Support de soudage magnétique ES Soporte de Soldadura magnética HR Magnetni kutnik za varenje, strijela HU Mágneses hegesztő adapter RO Adaptor magnetic de sudura BG Магнитен позиционер за заваряване



MAGNETIC 45° 90° 135° max Ø28mm

HT3B650	34 kg	6	24
HT3B651	22,5 kg	6	24

DE Magnet werkstückhalter EN Magnetic welding holder FR Support de soudage magnétique ES Soporte de Soldadura magnética HR Magnetni kutnik za varenje, trokut HU Mágneses háromszög alakú adapter RO Adaptor triunghiular magnetic de sudura BG Магнитен позиционер за заваряване



MAGNETIC 36,2 kg 30° 45° 60° 90° max Ø28mm

HT3B660	36,2 kg	6	24
---------	---------	---	----

DE Kartuschenpresse EN Caulking gun FR Pistolet à mastic ES Pistola de masilla HR Pištolji za kartuše plastične mase HU Kinyomó pisztoly RO Presa cartuse BG Пистолет за картуш



DOUBLE SYSTEM ROTATION 360°

HT4R402	225 mm	1	24
---------	--------	---	----

DE Kreidelinie EN Chalk line FR Corde traser à la craie ES Cuerda traser con tiza HR Traser niz s kredom HU Traser húr krétával RO Traser șir cu cretă BG Низ за трасьори с креда



NEW

30 m BLUE

HT4B313	30 m	12	48
---------	------	----	----

DE Saugnapf EN Lifter FR Ventouse ES Ventosa HR Usisna čaša HU Siurbtukas RO Tapadókorong BG Всмукателната чаша



NEW

MAX 40 kg 120 mm GLASS CERAMICS

HT4B315	40 kg	1	48
---------	-------	---	----

DE Cuttermesser EN Snap-off blade knife FR Couteau à lame cassable ES Cuchillo con hoja rompible HR Nož s oštricom za lomljenje HU Tapétavágó kés RO Cutter cu lama fractionabila BG Макетен нож с чулещо се острие



HT4C603-D	9 mm	85 mm	24	288
	21 mm	136 mm		

DE Cuttermesser EN Snap-off blade knife FR Cutter à lame rétractable ES Cortador con cuchilla retráctil HR Nož s oštricom za lomljenje HU Tapétavágó kés RO Cutter cu lama fractionabila BG Макетен нож с чулещо се острие



HT4C605	18 mm	100 mm	12	240
	45 mm	165 mm		

DE Reißnadel EN Scriber FR Pointe ES Punta HR Píсар HU Gramfontű RO Stylus BG Писар



NEW

METAL GLASS CERAMICS

HT4B314	145 mm	24	240
---------	--------	----	-----

DE Saugnapf EN Lifter FR Double ventouse ES Doble ventosa HR Dvostruka usisna čaša HU Dupla tapadókorong RO Ventuză dublă BG Двойна всмукване чаша



NEW

MAX 80 kg 120 mm GLASS CERAMICS

HT4B316	80 kg	1	18
---------	-------	---	----

DE Cuttermesser EN Snap-off blade knife FR Couteau à lame cassable ES Cuchillo con hoja rompible HR Nož s oštricom za lomljenje HU Tapétavágó kés RO Cutter cu lama fractionabila BG Макетен нож с чулещо се острие



HT4C604	18 mm	110 mm	12	144
	38 mm	165 mm		

DE Cuttermesser EN Snap-off blade knife FR Cutter à lame rétractable avec corps en zinc ES Cortador con cuchilla retráctil con cuerpo de zinc HR Nož s oštricom za lomljenje HU Tapétavágó kés RO Cutter cu lama fractionabila BG Макетен нож с чулещо се острие



HT4C606	18 mm	110 mm	12	120
	40 mm	158 mm		

DE Cuttermesser EN Snap-off blade knife FR Couteau à lame sécable ES Cortador con cuchilla retráctil HR Nož s oštricom za lomljenje HU Tapétavágó kés RO Cutter cu lama fractionabila BG Макетен нож с чупещо се острие



SK4 STEEL	x5	BLADE PULL 20 KG
ABS TPR	ERGO GRIP	

HT4C607	18 mm	100 mm	12	96
	40 mm	165 mm		

DE Messer mit gebrochener Klinge EN Knife with replaceable blade FR Cutter ES Cortatubos HR Nož s oštricom za lomljenje HU Tapétavágó kés RO Cutter cu lama fractionabila BG макетен нож с подменителни остриета



SK4 STEEL	LASER CUTTING BLADE	ANTI-RUST BLADE
60 KG PULL-FORCE RESISTANCE	ERGO GRIP	

HT4C614	18 mm	110 mm	6	72
	40 mm	180 mm		

DE Messer mit Trapez klinge EN Trapezoidal blade knife FR Couteau à lame trapézoïdale ES Cuchilla con hoja trapezoidal HR Nož s trapeznom oštricom HU Trapéz pengés tapétavágó kés RO Cutter cu lama trapezoidala BG Нож макетен трапец



SK4 STEEL	LASER CUTTING BLADE	ANTI-RUST BLADE
ALU	ERGO GRIP	60 KG PULL-FORCE RESISTANCE

HT4C625	19 mm	60 mm	6	72
	40 mm	175 mm		

DE Cuttermesser EN Snap-off blade knife FR Couteau à lame cassable ES Cuchillo con hoja rompible HR Nož s oštricom za lomljenje HU Tapétavágó kés RO Cutter cu lama fractionabila BG Макетен нож с чупещо се острие



SK5	60 KG PULL-FORCE RESISTANCE	LASER CUTTING BLADE
AUTO-LOCK	PS + TPR	METAL GUIDE BAR

HT4C627	18 mm	12	144
---------	-------	----	-----

DE Messer mit gebrochener Klinge EN Knife with replaceable blade FR Cutter ES Cortatubos HR Nož s oštricom za lomljenje HU Tapétavágó kés RO Cutter cu lama fractionabila BG макетен нож с подменителни остриета



SK4 STEEL	LASER CUTTING BLADE	ANTI-RUST BLADE
60 KG PULL-FORCE RESISTANCE	ERGO GRIP	

HT4C613	18 mm	110 mm	12	144
	40 mm	180 mm		

DE Trapezklingen Messer EN Trapezoidal blade knife FR Couteau à lame trapézoïdale ES Cuchillo con hoja trapezoidal HR Nož s trapeznom oštricom HU Trapéz pengés tapétavágó kés RO Cutter cu lama trapezoidala BG Нож макетен трапец



SK5 STEEL	x3	AUTO-RETRACTABLE	BELT-CUT
EASY CHANGE	MULTI STOP	ERGO GRIP	

HT4C622	19 mm	61 mm	12	72
	175 mm	40 mm		

DE Cuttermesser EN Snap-off blade knife FR Couteau à lame cassable ES Cuchillo con hoja rompible HR Nož s oštricom za lomljenje HU Tapétavágó kés RO Cutter cu lama fractionabila BG Макетен нож с чупещо се острие



SK2H	XTREME SHARP EDGE	LASER CUTTING BLADE
ANTI-RUST BLADE	ABS	LOCK-BUTTON

HT4C626	18 mm	30	240
---------	-------	----	-----

DE Cuttermesser EN Snap-off blade knife FR Couteau à lame cassable ES Cuchillo con hoja rompible HR Nož s oštricom za lomljenje HU Tapétavágó kés RO Cutter cu lama fractionabila BG Макетен нож с чупещо се острие



SK2H	XTREME SHARP EDGE	20 KG PULL-FORCE RESISTANCE	LASER CUTTING BLADE
ANTI-RUST BLADE	AUTO-LOCK	ABS	METAL GUIDE BAR

HT4C628	9 mm	10	240
HT4C629	18 mm	10	120

DE Cuttermesser EN Snap-off blade knife FR Couteau à lame cassable ES Cuchillo con hoja rompible HR Nož s oštricom za lomljenje HU Tapétavágó kés RO Cutter cu lama fractionabila BG Малък макетен нож с чупещо се острие



SK5	x5	LASER CUTTING BLADE	20 KG PULL-FORCE RESISTANCE
AUTO-LOCK	ABS + TPR	METAL GUIDE BAR	

HT4C630	18 mm	12	144
---------	-------	----	-----

DE Cuttermesser EN Snap-off blade knife FR Couteau à lame cassable ES Cuchillo con hoja rompible HR Nož s oštricom za lomljenje HU Tapétavágó kés RO Cutter cu lama fractionabila BG Малък макетен нож с чупещо се острие



SK5	20 KG PULL-FORCE RESISTANCE	LASER CUTTING BLADE
AUTO-LOCK	ALU	METAL GUIDE BAR

HT4C635	9 mm	12	240
HT4C636	18 mm	12	144

DE Cuttermesser EN Snap-off blade knife FR Couteau à lame cassable ES Cuchillo con hoja rompible HR Nož s oštricom za lomljenje HU Tapétavágó kés RO Cutter cu lama fractionabila BG Малък макетен нож с чупещо се острие



SK5	60 KG PULL-FORCE RESISTANCE	LASER CUTTING BLADE
AUTO-LOCK	ABS + TPR	METAL GUIDE BAR

HT4C638	25 mm	12	144
---------	-------	----	-----

DE Trapezklingen Messer EN Trapezoidal blade knife FR Couteau à lame trapézoïdale ES Cuchillo con hoja trapezoidal HR Nož s trapeznom oštricom HU Trapéz pengés tapétavágó kés RO Cutter cu lama trapezoidala BG Нож макетен трапец



x4	ALU	EASY CHANGE	MULTI STOP
----	-----	-------------	------------

HT4C640	19 x 60 mm	12	144
---------	------------	----	-----

DE Cuttermesser EN Snap-off blade knife FR Couteau à lame cassable ES Cuchillo con hoja rompible HR Nož s oštricom za lomljenje HU Tapétavágó kés RO Cutter cu lama fractionabila BG Малък макетен нож с чупещо се острие



SK2H	XTREME SHARP EDGE	20 KG PULL-FORCE RESISTANCE	AUTO-RETRACTABLE
LASER CUTTING BLADE	ANTI-RUST BLADE	AUTO-LOCK	ABS
METAL GUIDE BAR	SL	CAN OPENER	

HT4C632	18 mm	10	120
---------	-------	----	-----

DE Cuttermesser EN Snap-off blade knife FR Couteau à lame cassable ES Cuchillo con hoja rompible HR Nož s oštricom za lomljenje HU Tapétavágó kés RO Cutter cu lama fractionabila BG Малък макетен нож с чупещо се острие

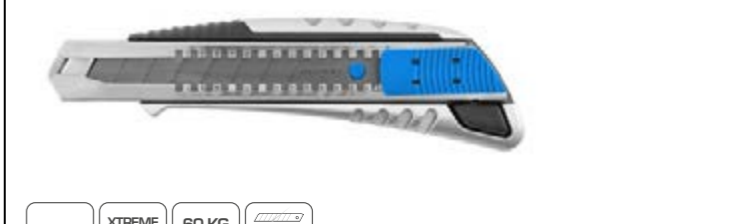

SK2H	XTREME SHARP EDGE	60 KG PULL-FORCE RESISTANCE	LASER CUTTING BLADE
ANTI-RUST BLADE	AUTO-LOCK	ALU + TPR	METAL GUIDE BAR

HT4C637	18 mm	12	144
---------	-------	----	-----

DE Trapezklingen Messer EN Trapezoidal blade knife FR Couteau à lame trapézoïdale ES Cuchillo con hoja trapezoidal HR Nož s trapeznom oštricom HU Trapéz pengés tapétavágó kés RO Cutter cu lama trapezoidala BG Нож макетен трапец



SK5	x4	ALU + TPR
EASY CHANGE	BELT CUT	90°/135°/180°

HT4C639	19 x 60 mm	12	144
---------	------------	----	-----

DE Trapezklingen Messer EN Trapezoidal blade knife FR Couteau à lame trapézoïdale ES Cuchillo con hoja trapezoidal HR Nož s trapeznom oštricom HU Trapéz pengés tapétavágó kés RO Cutter cu lama trapezoidala BG Нож макетен трапец



SK5	x4	ALU + ABS
EASY CHANGE	BELT CUT	MULTI STOP

HT4C641	19 x 60 mm	12	72
---------	------------	----	----



DE Trapezklingen Messer EN Trapezoidal blade knife FR Couteau à lame trapézoïdale ES Cuchillo con hoja trapezoidal HR Nož s trapeznom oštricom HU Trapéz pengés tapétavágó kés RO Cutter cu lama trapezoidală BG Нож макетен трапец



SK2H x4 XTREME SHARP EDGE AUTO-RETRACTABLE  
 ALU+ABS EASY CHANGE BELT CUT MULTI STOP

HT4C642	19 x 60 mm	12	72
---------	------------	----	----

DE Montagemesser EN Fitter's knife FR Couteau à lame incurvée repliable ES Cuchillo plegable de hoja curva HR Monterski nož HU Szerelő bicska RO Cutit cu varf ascutit BG Монтърски нож



3Cr13 STEEL WOODEN HANDLE

HT4C651	2,5 mm	198 mm	12	72
---------	--------	--------	----	----

DE Abbrechklinge EN Snap-off blades FR Pack de lames sécables ES Paquete de cuchillas con tiras desechables HR Oštrice za lomljenje HU Penge tapétavágó késhez RO Lama fractionabila BG Острие резервно чулещо се



9mm SK5 STEEL x10

HT4C661	9 mm	24	576
---------	------	----	-----

DE Abbrechklinge EN Trapezoidal blades FR Pack de lames trapézoïdales ES Paquete de cuchillas trapezoidales HR Trapezne oštrice HU Trapéz penge tapétavágó késhez RO Lama trapezoidală BG Трапецовидно резервно острие



19mm SK5 STEEL x10 LASER CUTTING BLADE

HT4C667	61 mm	0,45 mm	60	480
---------	-------	---------	----	-----

DE Montagemesser EN Fitter's knife FR Couteau à lame repliable ES Cuchillo de hoja plegable HR Monterski nož HU Szerelő bicska RO Cutit cu varf ascutit BG Монтърски нож



3Cr13 STEEL WOODEN HANDLE

HT4C650	2,5 mm	210 mm	12	72
---------	--------	--------	----	----

DE Universalmesser EN Universal knife FR Couteau universel ES Cuchillo universal HR Univerzalni nož HU Szerelő kés RO Cutit de montare BG Универсален нож



STEINLESS STEEL BELT HANGER

HT4C652	100 mm	12	72
---------	--------	----	----

DE Abbrechklinge EN Snap-off blades FR Pack de lames sécables ES Paquete de cuchillas con tiras desechables HR Oštrice za lomljenje HU Penge tapétavágó késhez RO Lama fractionabila BG Острие резервно чулещо се



18mm SK5 STEEL x10

HT4C662	18 mm	24	288
---------	-------	----	-----

DE Hakenklingen EN Trapezoidal hook blades FR Pack de lames trapézoïdales à crochet ES Paquete de cuchillas trapezoidales con gancho HR Kukaste oštrice HU Trapéz kampós penge tapétavágóhoz RO Lama trapezoidală tip carlig BG Трапецовидно резервно острие



19mm SK5 STEEL x5

HT4C668	61 mm	0,45 mm	24	576
---------	-------	---------	----	-----

DE Abbrechklinge EN Trapezoidal blades FR Lames à trapézoïdales cassants ES Recambio para cuchilla trapezoidales negro HR Trapezne oštrice HU Trapéz penge tapétavágó késhez RO Lama trapezoidală BG Трапец резервно острие кука



19mm SK4 STEEL x10 Xtreme Sharp Edge ANTI-RUST BLADE LASER CUTTING BLADE

HT4C669	61 mm	0,45 mm	20	240
---------	-------	---------	----	-----

DE Abbrechklinge EN Snap-off blades FR Pack de lames sécables ES Paquete de cuchillas con tiras desechables HR Oštrice za lomljenje HU Penge tapétavágó késhez RO Lama fractionabila BG Острие резервно чулещо се



18mm SK2 x10 LASER CUTTING BLADE

HT4C671	18 mm	10	120
---------	-------	----	-----

DE Abbrechklinge EN Snap-off blades FR Pack de lames sécables ES Paquete de cuchillas con tiras desechables HR Oštrice za lomljenje HU Penge tapétavágó késhez RO Lama fractionabila BG Острие резервно чулещо се



19mm SK2 x10 LASER CUTTING BLADE

HT4C673	61 mm	0,6 mm	10	240
---------	-------	--------	----	-----

DE Abbrechklinge EN Snap-off blades FR Pack de lames sécables ES Paquete de cuchillas con tiras desechables HR Oštrice za lomljenje HU Penge tapétavágó késhez RO Lama fractionabila BG Острие резервно чулещо се



SK2H XTREME SHARP EDGE x10 LASER CUTTING BLADE ANTI-RUST BLADE

HT4C670	9 mm	10	120
---------	------	----	-----

DE Abbrechklinge EN Snap-off blades FR Pack de lames sécables ES Paquete de cuchillas con tiras desechables HR Oštrice za lomljenje HU Penge tapétavágó késhez RO Lama fractionabila BG Острие резервно чулещо се



18mm SK2H XTREME SHARP EDGE x10 LASER CUTTING BLADE ANTI-RUST BLADE

HT4C672	18 mm	10	120
---------	-------	----	-----

DE Abbrechklinge EN Snap-off blades FR Pack de lames sécables ES Paquete de cuchillas con tiras desechables HR Oštrice za lomljenje HU Penge tapétavágó késhez RO Lama fractionabila BG Острие резервно чулещо се



19mm SK2H XTREME SHARP EDGE x10 LASER CUTTING BLADE ANTI-RUST BLADE

HT4C674	61 mm	0,6 mm	10	240
---------	-------	--------	----	-----

**HÖGERT**  
technik

DE Messgeräte  
EN Measuring Tools  
FR Outils De Mesure  
ES Herramientas De Medición  
HR Mjerni alati  
HU Mérőszerszámok  
RO Unelte De Măsură  
BG Измерващи Инструменти



DE Bandmaß EN Tape measure FR Mètre ruban magnétique ES Cinta métrica HR Uvlačiv metar HU Mérőszalag RO Rulete de buzunar BG Ролетка

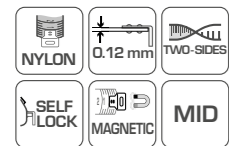

Model	Length	Width	Units	Quantity
HT4M400	3 m	16 mm	12	120
HT4M401	5 m	19 mm	12	120
HT4M402	8 m	25 mm	6	60

DE Bandmaß EN Tape measure FR Mètre ruban magnétique ES Cinta métrica automática y ergonómica HR Uvlačiv metar HU Mérőszalag RO Rulete de buzunar BG Ролетка

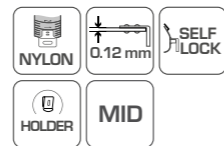

Model	Length	Width	Units	Quantity
HT4M423	3 m	16 mm	12	120
HT4M425	5 m	19 mm	12	96

DE Bandmaß EN Tape measure FR Mètre ruban magnétique ES Cinta métrica automática y ergonómica HR Uvlačiv metar HU Mérőszalag RO Rulete de buzunar BG Ролетка

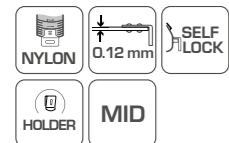

Model	Length	Width	Units	Quantity
HT4M426	5 m	25 mm	6	60
HT4M428	8 m	25 mm	6	48

DE Bandmaß EN Tape measure FR Mètre ruban magnétique ES Cinta métrica HR Uvlačiv metar HU Mérőszalag RO Rulete de buzunar BG Ролетка

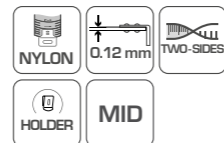

Model	Length	Width	Units	Quantity
HT4M405	3 m	16 mm	12	120
HT4M406	5 m	19 mm	12	120
HT4M407	8 m	25 mm	6	60

DE Bandmaß EN Steel tape measure FR Ruban à mesurer ES Cinta métrica automática con imán HR Uvlačiv metar s magnetom HU Mágneses mérőszalag RO Rulete de buzunar cu magnet BG Стомана ролетка



Model	Length	Width	Units	Quantity
HT4M432	3 m	16 mm	12	120

DE Bandmaß EN Steel tape measure FR Mètre ruban acier ES Metro metálico extensible con bloqueo HR Uvlačiv metar HU Mérőszalag RO Rulete de buzunar BG Стомана ролетка

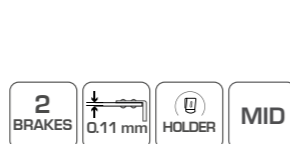

Model	Length	Width	Units	Quantity
HT4M409	3 m	16 mm	12	120
HT4M410	5 m	19 mm	12	120
HT4M411	8 m	25 mm	6	60

DE Bandmaß EN Steel tape measure FR Ruban à mesurer ES Cinta métrica automática HR Uvlačiv metar HU Mérőszalag RO Rulete de buzunar BG Стомана ролетка



Model	Length	Width	Units	Quantity
HT4M429	3 m	16 mm	12	120

DE Kapselbandmass EN Steel tape measure FR Triple décimètre ES Cinta métrica de acero HR Čelična metar HU Hosszú acél mérőszalag RO Masura lunga din oțel BG Ролетка със стоманена лента



Model	Length	Width	Units	Quantity
HT4M473	30 m	9.5 mm	10	40



DE Kapselbandmass EN Steel tape measure FR Triple décimètre ES Cinta métrica de acero HR Celična metar HU Hosszú acél mérőszalag RO Masura lunga din otel BG Ролетка със стоманена лента



STEEL	NYLON	3x SPEED				
MID	ERGO GRIP					
HT4M475	↔ 50 m	⊥ 12,5 m	10	20		

DE Glasfaser-Rollbandmaß EN Fibreglass measure FR Mètre ruban en fibre de verre ES Cinta métrica de fibra de vidrio HR Metar od fiberglasa HU Üvegszalag mérőszalag RO Masura din fibra de sticla BG Дълга ролетка от фибростъкло

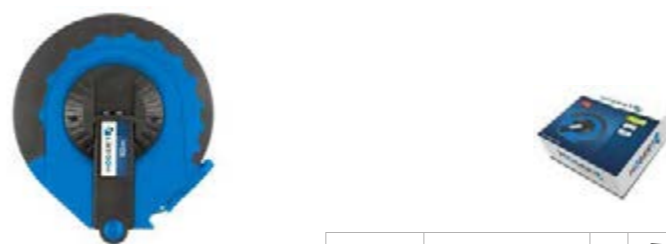

VINYL COATED	0.5 mm	FAST SPEED				
MID	ERGO GRIP					
HT4M476	↔ 10 m	⊥ 15 mm	1	60		
HT4M477	↔ 20 m	⊥ 15 mm	1	60		
HT4M478	↔ 30 m	⊥ 15 mm	1	40		
HT4M479	↔ 50 m	⊥ 15 mm	1	30		

DE Laser-Entfernungsmesser EN Laser Distance Meter FR Télémètre à laser ES Telémetro láser HR Laserski metar HU Lézeres távolságmérő RO Control distanta laser BG Лазерен далекомер

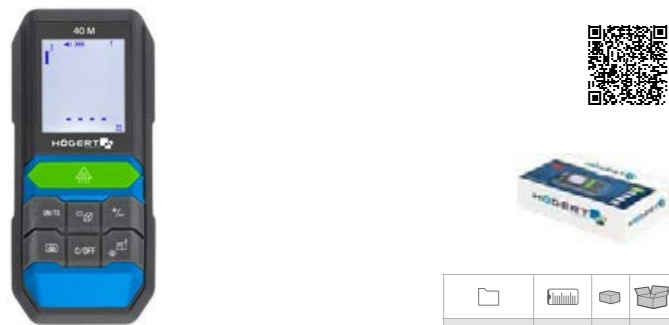

40 M						
m <sup>2</sup> /m <sup>2</sup>	m	MEMORY x 30	± 2 mm	CLASS II		
HT4M322	40 m	1	60			
HT4M323	60 m	1	60			
HT4M324	80 m	1	40			

DE Holz Zollstock EN Wooden tape measure FR Règle pliante en bois ES Metro plegable de madera HR Drvena člankasta mjerka HU Mérőléc RO Metre pliabile BG Дървен сгъваем метър



6 FOLDS	POCKET SIZE					
DURABLE	MID					
HT4M261-D	↔ 1 m	⊥ 2,3 mm	⊥ 16 mm	20	200	

DE Holz Zollstock EN Wooden tape measure FR Règle pliante en bois ES Metro plegable de madera HR Drvena člankasta mjerka HU Mérőléc RO Metre pliabile BG Дървен сгъваем метър



10 FOLDS	DURABLE	MID				
HT4M262	↔ 2 m	⊥ 2,3 mm	⊥ 16 mm	10	100	

DE Messschieber EN Vernier caliper FR Pied à coulisse ES Calibrador o Pie de Rey HR Pomična mjerka HU Tolómérő RO Subler BG Шублер



0.02 mm	mm/inch	STEEL				
DIN 862						
HT4M270	↔ 150 mm	↔ 230 mm	10	50		

DE Digitaler Messschieber EN Digital caliper FR Pied à coulisse digital ES Calibrador digital HR Digitalna pomična mjerka HU Digitális tolómérő RO Subler digital BG Дигитален шублер



0.01 mm	mm/inch	STAINLESS STEEL				
IP54	CLEAR LCD	CR 2032 BATTERY				
HT4M274	↔ 150 mm	↔ 230 mm	10	50		

DE Schreiner Alu-Winkel EN Aluminium carpenter square FR Equerre aluminium ES Escuadra de carpintero HR Stolarski kutnik HU Alumínium asztalos derékszög RO Echer dulgher din aluminiu BG Дърводелски ъгъл



AI	TWO-SIDES	90°				
HT4M202	↔ 250 m	⊥ 190 mm	1	100		
HT4M203	↔ 350 m	⊥ 190 mm	12	60		
HT4M206	↔ 450 m	⊥ 190 mm	1	100		

DE Schreiner - Winkel EN Aluminium carpenter square FR Equerre de menuisier en aluminium ES Escuadra de carpintero de aluminio 300mm HR Stolarski kutnik HU Alumínium asztalos derékszög RO Echer dulgher din aluminiu BG Дърводелски ъгъл

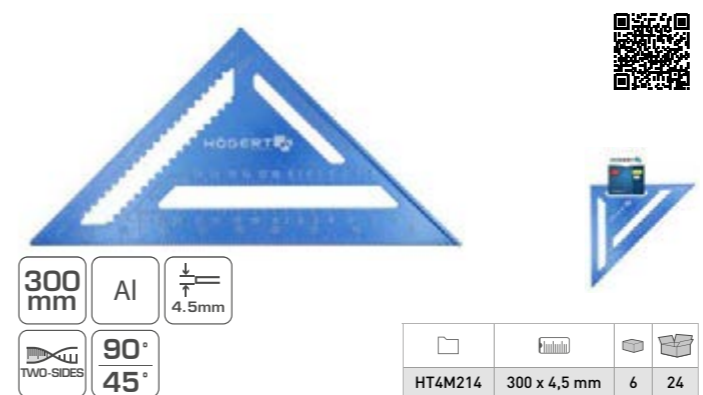

300 mm	AI	4.5 mm				
90°	45°					
HT4M214	300 x 4,5 mm	6	24			

DE Dreieck Winkel Schreiner EN Carpenter square FR Equerre de charpente triangulaire ES Escuadra de carpintero HR Tesarski kutnik HU Asztalos derékszög RO Echer dulgher din aluminiu BG Измервателен триъгълник дърводелски

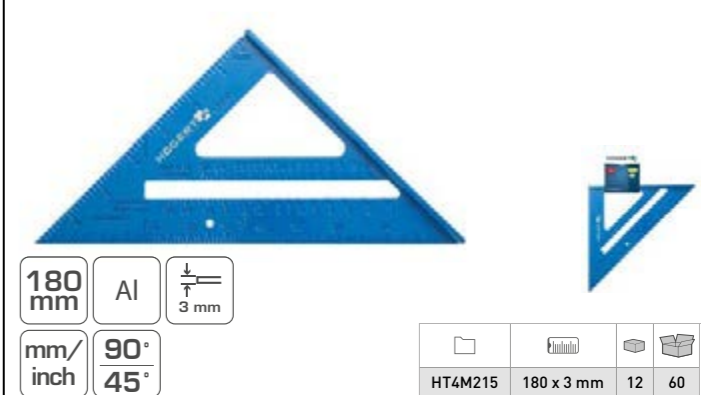

180 mm	AI	3 mm				
mm/inch	90°	45°				
HT4M215	180 x 3 mm	12	60			

DE Dreieck Winkel Schreiner EN Carpenter square FR Equerre de charpente triangulaire ES Escuadra de carpintero HR Tesarski kutnik HU Asztalos derékszög RO Echer dulgher din aluminiu BG Измервателен триъгълник дърводелски

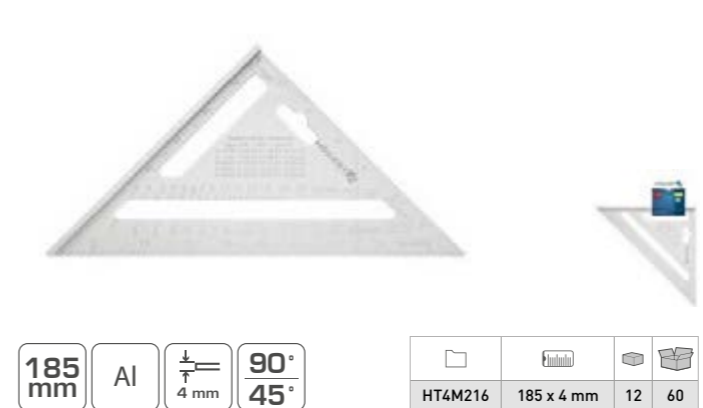

185 mm	AI	4 mm	90°	45°		
HT4M216	185 x 4 mm	12	60			

DE Kombinationswinkel EN Combination square FR Combination square ES Escuadra de carpintero con nivel HR Stolarski kutnik sa libelom HU Asztalos derékszög vízmértékkel RO Echer dulgher cu dreptare BG Прав ъгъл с нивелир

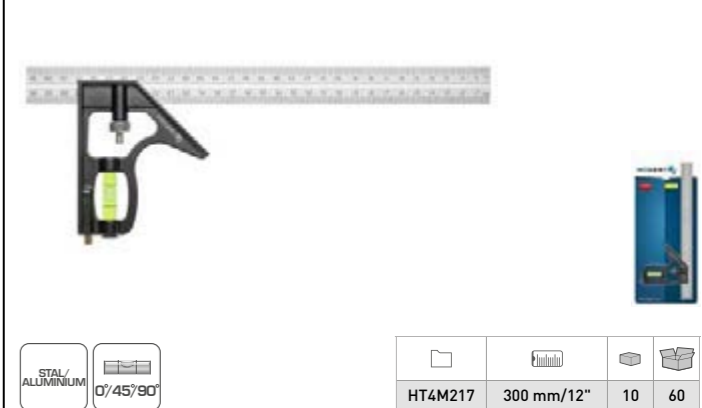

STAL/ALUMINIUM	0°/45°/90°					
HT4M217	300 mm/12"	10	60			

DE Wasserwaage EN Spirit level FR Niveau à fioles ES Nivel con burbujas HR Libela HU Vízérték RO Dreptare BG Нивелир с три либели

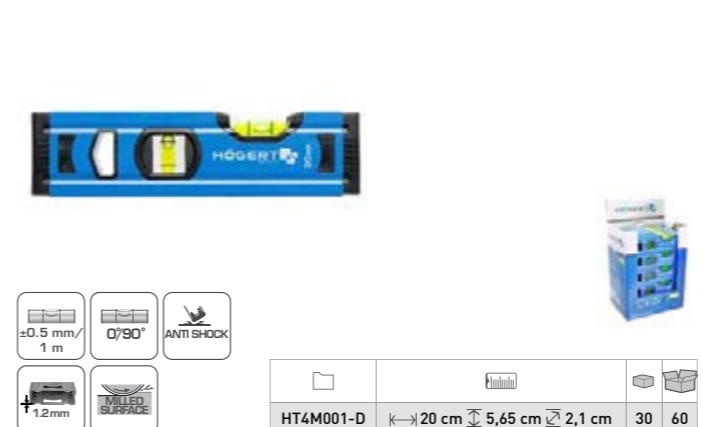

±0.5 mm/1 m	0°/90°	ANTI SHOCK				
HT4M001-D	↔ 20 cm	⊥ 5,65 cm	⊥ 2,1 cm	30	60	

DE Wasserwaage Torpedo EN Spirit level torpedo FR Niveau magnétique Torpedo ES Nivel magnético Torpedo con burbujas HR Libela s magnetom HU Mágneses vízmérték RO Dreptare cu magnet BG Нивелир с три либели



±1 mm/1 m	0°/45°/90°	MAGNETIC				
HT4M040	↔ 22 cm	⊥ 4,72 cm	⊥ 2,0 cm	1	50	

DE Wasserwaage EN Aluminium level FR Niveau Aluminium ES Nivel de aluminio HR Aluminijska libela HU Alumínium vízmérték RO Dreptare din aluminiu BG Професионален алуминиев нивелир с три либели



±0.5 mm/1 m	0°/90°	VERTICAL VIEW				
HT4M003	23 cm	1	24			

DE Wasserwaage EN Aluminium level, vertical view FR Niveau Aluminium ES Nivel de aluminio HR Aluminijska libela HU Alumínium vízmérték RO Dreptare din aluminiu BG Професионален алуминиев нивелир с три либели



±0.5 mm/1 m	0°/45°/90°	VERTICAL VIEW				
HT4M005	40 cm	1	30			
HT4M007	60 cm	1	20			
HT4M009	80 cm	1	20			
HT4M011	100 cm	1	20			
HT4M013	120 cm	1	20			
HT4M016	150 cm	1	20			
HT4M021	200 cm	1	10			

DE Wasserwaage EN Spirit level FR Niveau Aluminium ES Nivel de aluminio HR Libela HU Vízérték RO Dreptare BG Нивелир



HT4M006	↔ 60 cm	⊥ 5,65 cm	↘ 2,1 cm	1	30
HT4M008	↔ 80 cm	⊥ 5,65 cm	↘ 2,1 cm	1	20
HT4M010	↔ 100 cm	⊥ 5,65 cm	↘ 2,1 cm	1	20
HT4M012	↔ 120 cm	⊥ 5,65 cm	↘ 2,1 cm	1	20
HT4M015	↔ 150 cm	⊥ 5,65 cm	↘ 2,1 cm	1	20
HT4M020	↔ 200 cm	⊥ 5,65 cm	↘ 2,1 cm	1	20

Icons: ±0.5 mm/1 m, 0/45/90°, ANTI-SHOCK, 1.3 mm, MILLED SURFACE

DE Stativ für Selbstnivellierung Laserkreuz EN Tripod for Laser levels FR Trépied pour Niveau Laser Autonivelant ES Tripode para Laseritase HR Stativ za Laserska Razina HU Állvány számára Lézeres szint RO Trepid pentru Nivelul laser BG Статив за лазерен нивелир



**NEW**

HT4M079	35 - 105 cm	1	25
---------	-------------	---	----

Icons: 1/4", AI

DE Laserkreuz EN Laser level red FR Niveau Laser Autonivelant ES Laseritase HR Laserska Razina HU Lézeres szint RO Nivelul laser BG Лазерен нивелир



**NEW**

HT4M070	10 m	1	10
---------	------	---	----

Icons: RED LASER, AUTO ± 4', AUTO LOCK, Horizontal, Vertical, Cross, ±0,5 mm/m, 650 Nm, CLASS II, 2xAA 1,5V, 1/2"

DE Laserkreuz EN Laser level red FR Niveau Laser Autonivelant ES Laseritase HR Laserska Razina HU Lézeres szint RO Nivelul laser BG Лазерен нивелир



**NEW**

HT4M071	24 m	1	10
---------	------	---	----

Icons: RED LASER, AUTO ± 3.5', AUTO LOCK, Cross & Side vertical, Side vertical, Cross, ±0,7 mm/m, 635 Nm, CLASS II, 2xAA 1,5V, 1/4", IP54, max 8 h, HOLDER

DE Laserkreuz EN Laser level red 3D FR Niveau Laser Autonivelant ES Laseritase HR Laserska Razina HU Lézeres szint RO Nivelul laser BG Лазерен нивелир



**NEW**

HT4M072	30 m	1	10
---------	------	---	----

Icons: RED LASER, AUTO ± 4', AUTO LOCK, 3D Horizontal, Side vertical, 3D horizontal & side vertical, ±0,5 mm/m, 635-660 Nm, CLASS II, 4xAA 1,5V, 1/4", IP54, max 10 h, HOLDER

DE Laserkreuz EN Laser level green FR Niveau Laser Autonivelant ES Laseritase HR Laserska Razina HU Lézeres szint RO Nivelul laser BG Лазерен нивелир



**NEW**

HT4M074	23 m	1	10
---------	------	---	----

Icons: GREEN LASER, AUTO ± 4', AUTO LOCK, Cross, Side vertical, ±0,3 mm/m, 505-520 Nm, CLASS II, 2x1Ah AA Ni-Mh, 1/4", IP54, max 18 h, MAGNETIC, HOLDER

DE Entfernungsmesser EN Profile detector FR Détecteur de matériaux ES Buscador De Estudios HR Detektor profila HU Vezeték detektor RO Detector profile BG Детектор за стени



**NEW**

HT4M340	122 g	1	20
---------	-------	---	----

Icons: I / I, 100 mm, Cu 80 mm, 40 mm, 38 mm, 88.888 ft inch

DE Entfernungsmesser mit Hygrometer EN Profile detector with hygrometer FR Détecteur de matériaux avec hygromètre ES Buscador De Estudios con higrómetro HR Detektor profila s higrometrom HU Profil-detektor higrométerrel RO Detector profile cu higrometru BG Детектор за стени с хигрометър



**NEW**

HT4M341	113 g	1	20
---------	-------	---	----

Icons: I / I, 60 mm, Cu 50 mm, 50 mm, 38 mm, %

DE Entfernungsmesser mit Laser-Entfernungsmesser 40m EN Profile detector with laser distance meter FR Détecteur de montant avec télémètre laser ES Buscador De Estudios con medidor de distancia láser HR Detektor profila s laserskim metrom HU Profil-detektor és lézeres távolságmérő RO Detector profil esi control de distanta laser BG Детектор за стени с лазерен далекомер



**NEW**

HT4M342	118 g	1	20
---------	-------	---	----

Icons: I / I, 100 mm, Cu 80 mm, 40 mm, 38 mm, 40 m, m, m²



DE Zubehör für Elektrogeräte  
EN Power tools accessories  
FR Accessoires pour outils électriques  
ES Accesorios para electro-herramientas  
HR Pribor za električne alate  
HU Elektromos szerszám tartozékok  
RO Accesorii pentru scule electrice  
BG Аксесоари за електроинструменти



DE Betonbohrer EN Masonry drill bit FR Foret à béton ES Broca para cemento HR Svrđala za beton HU SDS+ kőműves fúrószer RO SDS+ set de burghii dulgher BG Свредла за бетон

Folder	Ø	Length	Length	Weight	Quantity
HT7D915	6	110 mm	60 mm	100	400
HT7D916	6	160 mm	110 mm	80	320
HT7D917	6	210 mm	160 mm	60	240
HT7D918	6	260 mm	210 mm	50	200
HT7D923	8	160 mm	110 mm	80	320
HT7D924	8	210 mm	160 mm	50	200
HT7D925	8	260 mm	210 mm	50	200
HT7D929	10	160 mm	110 mm	60	240
HT7D930	10	210 mm	160 mm	50	200
HT7D931	10	260 mm	210 mm	50	200
HT7D933	10	460 mm	410 mm	30	120
HT7D934	10	600 mm	550 mm	20	80
HT7D937	12	210 mm	150 mm	50	200

Folder	Ø	Length	Length	Weight	Quantity
HT7D938	12	260 mm	200 mm	40	160
HT7D941	12	460 mm	400 mm	25	100
HT7D942	12	600 mm	540 mm	15	60
HT7D945	14	260 mm	200 mm	30	120
HT7D950	14	600 mm	540 mm	15	60
HT7D955	16	460 mm	400 mm	15	60
HT7D956	16	600 mm	540 mm	10	40
HT7D960	18	460 mm	400 mm	10	40
HT7D961	18	600 mm	540 mm	10	40
HT7D964	20	460 mm	400 mm	10	40
HT7D965	20	600 mm	540 mm	5	20
HT7D973	24	600 mm	540 mm	5	20

DE Betonbohrer EN Masonry drill bit FR Foret à béton à taillants et double cannelure ES Broca para hormigón con punta HR Svrđala SDS plus za beton HU SDS+ kőműves fúrószer RO SDS+ set de burghii dulgher BG Комплект свредла за бетон

Folder	Ø	Length	Length	Weight	Quantity
HT6D201	4,0	110 mm	50 mm	50	300
HT6D203	5,0	160 mm	90 mm	60	180
HT6D204	6,0	110 mm	50 mm	50	32
HT6D205	6,0	160 mm	90 mm	60	180
HT6D206	6,0	210 mm	135 mm	50	150
HT6D207	6,0	260 mm	185 mm	50	150
HT6D209	8,0	160 mm	90 mm	60	180
HT6D210	8,0	210 mm	135 mm	50	150
HT6D213	10,0	160 mm	90 mm	50	150
HT6D214	10,0	260 mm	185 mm	50	150
HT6D215	10,0	350 mm	280 mm	25	100

Folder	Ø	Length	Length	Weight	Quantity
HT6D218	12,0	160 mm	90 mm	50	150
HT6D220	12,0	260 mm	185 mm	50	150
HT6D224	12,0	600 mm	490 mm	20	80
HT6D226	14,0	260 mm	185 mm	40	120
HT6D231	14,0	600 mm	490 mm	1	50
HT6D233	16,0	260 mm	185 mm	25	75
HT6D236	16,0	600 mm	490 mm	10	40
HT6D237	18,0	260 mm	185 mm	15	45
HT6D240	18,0	600 mm	490 mm	10	40
HT6D242	20,0	600 mm	490 mm	5	40
HT6D248	24,0	600 mm	490 mm	1	20

DE Betonbohrer EN Masonry drill bit set FR Pack de forets à béton à taillants et double cannelure ES Paquete de brocas para hormigón HR Set svrdala SDS plus HU SDS+ kőműves fúrószer készlet RO SDS+ set de burghii dulgher BG Комплект свредла за бетон

Folder	Ø	Length	Length	Weight	Quantity
HT6D370	5,0	110 mm	50 mm	5	30
	6,0	110 mm	50 mm		
	6,0	160 mm	90 mm		
	8,0	160 mm	90 mm		
	10,0	160 mm	90 mm		

DE Spitzmeißel EN Pointed chisel FR Burin pointu ES Cincel de punta HR Šiljasto dljeto SDS plus HU SDS+ hegyes vésőszár RO Dalte ascutite SDS+ BG Длето конусно

Folder	Length	Weight	Quantity
HT6D280	14 x 250 mm	1	80

DE Flachmeißel EN Flat chisel FR Ciseau plat ES Cincel plano HR Ravna dljeta HU Lapos vésőszár RO Dalta lata BG Длето плоско

Folder	Length	Weight	Quantity
HT6D281	20 x 14 x 250 mm	1	75
HT6D282	40 x 14 x 250 mm	1	75

DE Kanalmeißel EN Gouge chisel FR Ciseau à gouge ES Cincel de ranura HR Dlijeto za žljebljenje SDS plus HU SDS+ marószár RO Dalte canale SDS+ BG Длето канално

Folder	Length	Weight	Quantity
HT6D284	22 x 14 x 250 mm	1	50

DE Adapter für Diamant Lochsäge EN Adapter for hole saw drill bits FR Adaptateur couronne diamantée ES Adaptador para broca HR SDS plus adapter za dijamantnu krunu za bušenje HU SDS+ adapter gyémánt koronafúróhoz RO Adaptor SDS+ pentru carote diamantate BG Адаптер за боркорона

Folder	Length	Weight	Quantity
HT6D470	110 mm	1	100

DE Adapter für Bohrkronen für Beton EN Adapter for hole saw drill bits FR Adaptateur pour forets à pointe carbure ES Adaptador broca de corona para hormigón HR Adapteri za krune od sinteriranog karbida za bušenje HU Adapter SDS+ karbidbetétes koronafúróhoz RO Adaptor pentru carote cu inerturi de carbid BG Адаптер за боркорона

Folder	Length	Weight	Quantity
HT6D490	110 mm	1	100

DE Diamant Lochsäge EN Diamond hole saw FR couronne diamantée ES Broca de corona de diamante HR Segmentirane dijamantne krune za bušenje HU Szegetált gyémánt koronafúró RO Carota diamantata pentru gaurire BG Диамантена боркорона

Folder	Length	Weight	Quantity
HT6D476	67 mm	68 mm	1 25
HT6D478	82 mm	70 mm	1 25

DE Bohrkronen für Beton EN Carbide hole-saw drill bits FR Forets à noyau carbure pour béton ES Broca de corona para hormigón HR Krune od sinteriranog karbida za bušenje HU Karbidbetétes koronafúrófej RO Carote cu inerturi de carbid BG Диамантена боркорона

Folder	Length	Weight	Quantity
HT6D484	65 mm	1	40
HT6D486	67 mm	1	20
HT6D487	80 mm	1	20
HT6D489	83 mm	1	20

DE Spitzmeißel EN Pointed chisel FR Burin pointu ES Cincel de punta HR Šiljasto dljeto HU Hegyes vésőszár RO Dalte ascutite BG Длето конусно

Folder	Length	Weight	Quantity
HT6D290	18 x 400 mm	1	25

DE Flachmeißel EN Flat chisel FR Burin plat ES Cincel plano HR Ravna dljeta HU Lapos vésőszár RO Dalta lata BG Длето плоско

Folder	Length	Weight	Quantity
HT6D291	25 x 18 mm	1	25

DE Flachmeißel EN Flat chisel FR Burin plat ES Cincel plano HR Ravna dljeta HU Lapos vésőszár RO Dalta lata BG Длето плоско

Folder	Length	Weight	Quantity
HT6D292	50 x 18 mm	1	25

DE Adapter für Bohrkronen für Beton EN Adapter for hole saw drill bits FR Adaptateur pour forets ES Adaptador HR Adapteri za krune od sinteriranog karbida za bušenje HU Adapter SDS+ karbidbetétes koronafúróhoz RO Adaptor pentru carote cu inerturi de carbid BG Адаптер за боркорона

Folder	Length	Weight	Quantity
HT6D492	160 mm	1	50

DE Betonbohrersatz EN Masonry drill bit set FR Jeu de forets à béton ES Juego de brocas para cemento HR Set svrdala za beton HU Kőműves fúrószer RO Burghii dulgher BG Комплект средла за бетон



HT6D378	Ø	L	l	Box	Box
x5	4 mm	75 mm		6	60
	5 mm	85 mm			
	6 mm	100 mm			
	8 mm	120 mm			
	10 mm	120 mm			



DE Betonbohrer EN Masonry drill bit FR Foret à béton à taillants ES Broca para hormigón con punta HR Svrdala za beton HU Kőműves fúrószer RO Set de burghii dulgher BG Средло за бетон



HT6D380	Ø	L	l	Box	Box
HT6D380	4,0	75 mm	45 mm	100	400
HT6D381	5,0	85 mm	45 mm	100	400
HT6D382	6,0	100 mm	60 mm	100	400
HT6D383	6,0	150 mm	100 mm	50	400
HT6D384	8,0	120 mm	75 mm	50	400
HT6D385	8,0	200 mm	140 mm	50	200
HT6D388	10,0	120 mm	75 mm	50	200
HT6D389	10,0	200 mm	140 mm	50	200
HT6D392	12,0	120 mm	75 mm	50	200



DE Metallbohrer EN Masonry drill bit FR Set de forets pour métal ES Broca para metal HR Svrdala za metal HU Fúrószer fémhez RO Burghii pentru metal BG Средло за метал

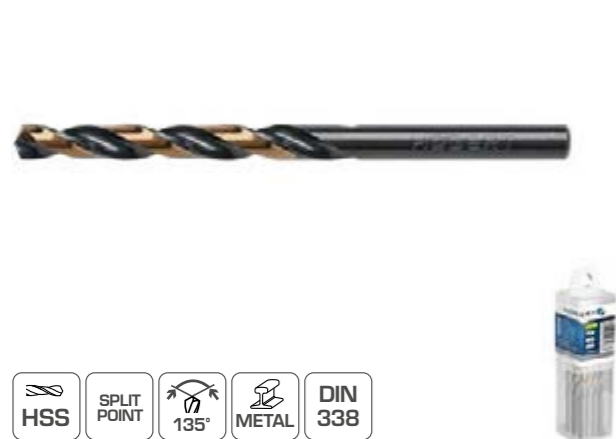

HT6D802	Ø	L	l	Box	Box
HT6D802	1,0	34 mm	12 mm	50	300
HT6D807	1,5	40 mm	18 mm	50	300
HT6D812	2,0	49 mm	24 mm	50	300
HT6D817	2,5	57 mm	30 mm	50	300
HT6D822	3,0	61 mm	33 mm	50	300
HT6D824	3,2	65 mm	36 mm	50	300
HT6D825	3,3	65 mm	36 mm	50	300
HT6D827	3,5	70 mm	39 mm	50	300
HT6D832	4,0	75 mm	43 mm	50	300
HT6D834	4,2	75 mm	43 mm	10	100
HT6D837	4,5	80 mm	47 mm	10	100
HT6D840	4,8	86 mm	52 mm	10	100
HT6D842	5,0	86 mm	52 mm	10	100
HT6D844	5,2	86 mm	52 mm	10	100
HT6D847	5,5	93 mm	57 mm	10	100
HT6D852	6,0	93 mm	57 mm	10	100
HT6D854	6,2	101 mm	63 mm	10	60



DE Metallbohrer EN Masonry drill bit FR Pack de forets à métaux ES Paquete de brocas para metal HR Svrdala za metal HU Fúrószer fémhez RO Burghii pentru metal BG Свредло за метал

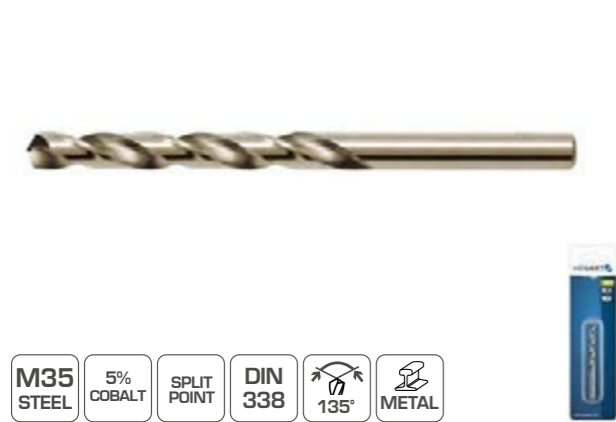

HT6D103	Ø	L	l	Box	Box
HT6D103	1,0	34 mm	12 mm	1	100
HT6D104	1,5	40 mm	18 mm	1	100
HT6D105	2,0	49 mm	24 mm	1	100
HT6D108	2,5	57 mm	30 mm	1	100
HT6D109	3,0	61 mm	33 mm	1	100
HT6D111	3,2	65 mm	36 mm	1	80
HT6D112	3,5	70 mm	39 mm	1	80
HT6D114	4,0	75 mm	43 mm	1	80
HT6D116	4,2	75 mm	43 mm	1	80
HT6D117	4,5	80 mm	47 mm	1	80
HT6D119	5,0	86 mm	52 mm	1	80



DE Metallbohrer-Set EN Metal drill bit set FR Jeu de forets à métaux ES Juego de brocas para metal HR Set svrdla za metal HU Fém fúrókészlet RO Set burghie pentru metal BG Комплект средла за метал



HT6D800	Box	Box
HT6D800	x 25	20



DE Metallbohrer-Set EN Metal drill bit set FR Jeu de forets à métaux ES Juego de brocas para metal HR Set svrdla za metal HU Fém fúrókészlet RO Set burghie pentru metal BG Комплект средла за метал



HT6D900	Box	Box
HT6D900	x 19	10



DE Metallbohrer EN Metal drill bit set FR Jeu de 6 forets à métaux ES Paquete de de brocas para metal HR Set svrdala za metal HU Fúrószer fémhez RO Burghii pentru metal BG Комплект средла



HT6D186	Ø	L	l	Box	Box
x6	2,0	49 mm	24 mm	6	60
	3,0	61 mm	33 mm		
	4,0	75 mm	43 mm		
	5,0	86 mm	52 mm		
	6,0	93 mm	57 mm		
	8,0	117 mm	75 mm		

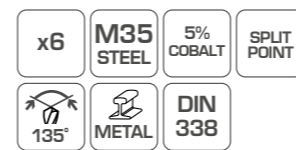

DE Mehrfasenbohrer EN Subland step drill bit FR Foret à bois à étages ES Broca para madera de etapas HR Dvostupanjsko svrdlo HU Lépcsős fúró RO Burghii cu trepte BG средло двустепенно



HT6D330	Ø	L	l	Box	Box
HT6D330	6,5/9,5 mm	85 mm	42 mm	10	200

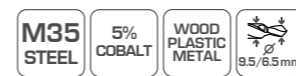

DE Bohrer Sah EN Drill saw bits set FR Pack de forets HSS-TiN multimatériaux ES Paquete de brocas con sierra para múltiples materiales HR Set svrdala- pila HU Fűrő-maró szer RO Burghii pentru taiere si gaurire BG Комплект средла - пили



HT6D336	Ø	L	l	Box	Box
x3	5,0 mm	73 mm	40	160	
	6,0 mm	84 mm			
	8,0 mm	92 mm			



DE Metallbohrer mit Sechskantschaft EN Metal drill bit set FR Pack de forets à métaux ES Paquete de brocas para metal HR Set svrdala za metal HU Fúrószer fémhez RO Set de burghii pentru metal BG Комплект средла за бетон



HT6D180	Ø	L	l	Box	Box
x5	4,0	95 mm	43 mm	10	100
	5,0	106 mm	52 mm		
	6,0	113 mm	57 mm		
	8,0	117 mm	75 mm		
	10,0	133 mm	87 mm		

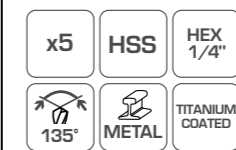

DE De Bohrer für Glas und Keramikfliesen EN Glass and tile drill bit FR Foret pour verre et céramique ES Broca para vidrio y cerámica HR Svrdala za staklo i keramičke pločice HU Üveg és csempefúró szer RO Burghii pentru sticla si faianta BG средло двустепенно



HT6D084	Ø	L	Box	Box
HT6D084	4,0	65 mm	50	200
HT6D085	5,0	68 mm	50	200
HT6D086	6,0	72 mm	50	200
HT6D088	8,0	80 mm	50	200
HT6D090	10,0	90 mm	50	200



DE Stufenbohrer EN Step drill FR Mèche progressive ES Broca escalonada HR Bitovi bušilice za koračno bušenje HU Lépcsős fúrók RO Burghie în trepte BG Конусно средло за ламарина



HT6D321	Ø	Box	Box
HT6D321	4-12 mm	10	100
HT6D322	4-20 mm	10	100
HT6D323	4-32 mm	10	100

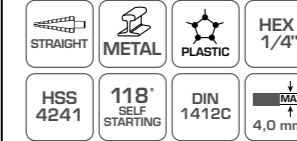

DE Stufenbohrer EN Step drill FR Mèche progressive ES Broca escalonada HR Bitovi bušilice za koračno bušenje HU Lépcsős fúrók RO Burghie în trepte BG Конусно средло за ламарина



HT6D324	Ø	Box	Box
HT6D324	4-39 mm	10	50

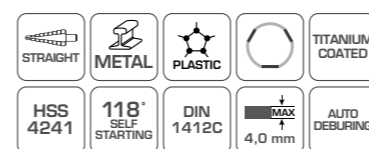

DE Stufenbohrer-Set EN Step drill set FR Jeu de forets étagés ES Juego de brocas escalonadas HR Bitovi bušilice za koračno bušenje HU Lépcsős fúrók RO Burghie în trepte BG Комплект конусно средло за ламарина

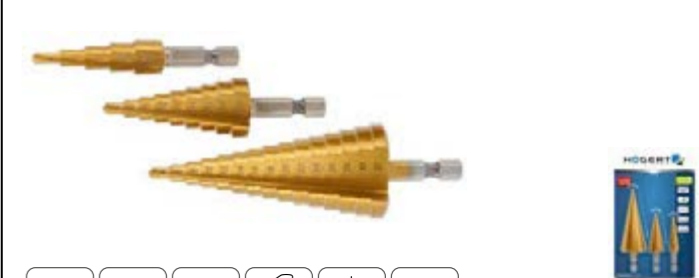

HT6D325	Ø	Box	Box
HT6D325	4-12 mm, 4-20 mm, 4-32 mm	10	50

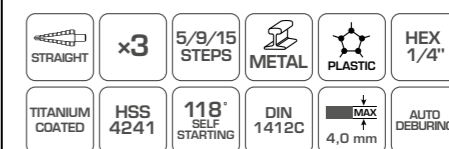



DE Spiral-Stufenbohrer EN Step drill spiral FR Foret étagé ES Broca escalonada HR Bitovi spiralne bušilice za koračno bušenje HU Spirális lépcsős fúrók RO Burghie în trepte spirale BG Конусно свредло спирален канал

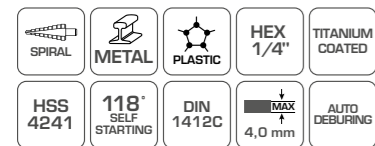

HT6D326	4-32 mm	10	100
---------	---------	----	-----

DE Holzbohrer EN Wood drill bit FR Foret à bois ES Broca para madera HR Svrđala za drvo HU Fafúró RO Burghii pentru lemn BG Средло за дърво

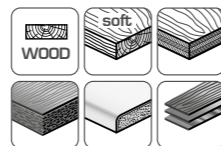

HT6D523	3,0	60 mm	60	240
HT6D524	4,0	70 mm	60	240
HT6D525	5,0	85 mm	60	240
HT6D526	6,0	90 mm	60	240
HT6D527	7,0	105 mm	60	240
HT6D528	8,0	110 mm	60	240
HT6D530	10,0	120 mm	60	240

DE Holz-Drillbohrer EN Auger drill bit FR Foret à bois à pointe de centrage ES Broca para madera con punta HR Spiralna svrdala za drvo HU Fafúró RO Burghii pentru lemn BG Свредло спирално за дърво

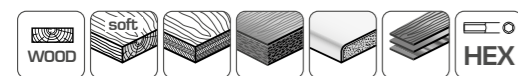

HT6D541	6,0	250 mm	180 mm	50	200
HT6D543	8,0	250 mm	180 mm	50	200
HT6D544	8,0	400 mm	310 mm	50	200
HT6D545	10,0	250 mm	180 mm	50	100
HT6D546	10,0	400 mm	310 mm	25	100
HT6D547	12,0	250 mm	180 mm	50	100
HT6D548	12,0	400 mm	310 mm	25	100
HT6D549	14,0	250 mm	180 mm	50	100
HT6D550	14,0	400 mm	310 mm	25	50

HT6D551	16,0	250 mm	180 mm	25	100
HT6D552	16,0	400 mm	310 mm	25	50
HT6D553	18,0	250 mm	180 mm	25	50
HT6D554	18,0	400 mm	310 mm	25	50
HT6D555	20,0	250 mm	180 mm	25	50
HT6D556	20,0	400 mm	310 mm	25	50
HT6D557	22,0	250 mm	180 mm	25	50
HT6D558	22,0	400 mm	310 mm	25	50

DE Holzbohrer EN Wood drill bit FR Mèche bois plate ES Broca de pala para madera HR Svrđala za drvo HU Fafúró RO Burghii pentru lemn BG Плоско свредло



HT7D110	10	152 mm	50	200
HT7D112	12	152 mm	50	200
HT7D114	14	152 mm	50	200
HT7D116	16	152 mm	50	200
HT7D118	18	152 mm	50	200
HT7D120	20	152 mm	50	200
HT7D122	22	152 mm	50	200
HT7D124	24	152 mm	50	200
HT7D125	25	152 mm	50	200
HT7D128	28	152 mm	50	200
HT7D130	30	152 mm	50	200
HT7D132	32	152 mm	50	200
HT7D135	35	152 mm	50	200
HT7D138	38	152 mm	50	200
HT7D140	40	152 mm	50	200

DE Verlängerung EN Extension FR Adaptateur pour Mèche bois plate ES Prolongador para brocas de pala HR Produžetak za lopatična svrdala HU Fafúró toldó RO Extensie pentru burghii BG Удължител за плоско свредло



HT7D158	150 mm	50	200
---------	--------	----	-----

DE Holzbohrer mit Sechskantschaft EN Hex shank stubby drill bit FR Foret tronqué à queue hexagonale ES Broca para madera con base hexagonal HR Svrđala za drvo HU Fafúró RO Burghii pentru lemn BG Свредло за дърво



HT6D344	4,0 mm	60 mm	35 mm	50	250
HT6D345	5,0 mm	60 mm	35 mm	50	250
HT6D346	6,0 mm	60 mm	35 mm	50	250
HT6D348	8,0 mm	60 mm	35 mm	50	250

DE Forstnerbohrer EN Forstner bit FR Fraise à bois d'encastrement ES Brocas Forstner bit para madera HR Cilindrična glodala HU Pánthely maró RO Capete de frezare pentru balamale BG Фрез за дърво



HT6D310	15	93,5 mm	8 mm	10	100
HT6D312	20	93,5 mm	8 mm	10	100
HT6D314	25	93,5 mm	8 mm	10	100
HT6D316	26	93,5 mm	8 mm	10	100
HT6D317	30	93,5 mm	8 mm	10	100
HT6D320	35	93,5 mm	10 mm	10	100



DE Versenkbohrer EN Countersink drill bit FR Foret à bois étagé ES Broca escalonada para madera HR Svrdla za potvrđivače HU Marófúró RO Burghii cu trepte BG Средла за конфирмат



HSS	DOUBLE FLUTE	WOOD	HT6D504	4,5 mm	90 mm	50 mm	10	250
			HT6D505	5,0 mm	90 mm	50 mm	10	250

DE Adapter für Lochsägen EN Bi-metal hole saw mandrel FR Foret pilote pour scie-cloche ES Broca de guía de sierra de perforación HR Adapteri za bimetalne krune za bušenje HU Bi-metál lyukfúró adapter fúrószárral RO Adaptor bi-metal pentru burghii cu ferastrau BG Адаптер за боркорона



HSS	HEX 7/16"	HT6D462	14-30 mm	10	100
		HT6D463 <td>32-152 mm <td>10 <td>100</td> </td></td>	32-152 mm <td>10 <td>100</td> </td>	10 <td>100</td>	100

DE Bimetall-Lochsägen EN Bi-metal hole saw FR Scie-cloche bi-métal ES Sierra bimetálica de perforación HR Bimetalne krune za bušenje HU Lyukfűrész fúrófejek RO Burghie cu ferastrau pentru gaurire BG Биметална боркорона



M42 STEEL	8% COBALT	BiMetal	4-6 TPI	METAL INOX	WOOD

HT6D404	20 mm	10	100	HT6D436	68 mm	10	50
HT6D406	22 mm	10	100	HT6D437	70 mm	10	50
HT6D408	25 mm	10	100	HT6D439	76 mm	5	50
HT6D410	29 mm	10	100	HT6D440	79 mm	5	50
HT6D412	32 mm	10	100	HT6D441	83 mm	5	50
HT6D414	35 mm	10	100	HT6D442	86 mm	5	50
HT6D416	38 mm	10	100	HT6D445	95 mm	5	20
HT6D417	40 mm	10	100	HT6D447	102 mm	5	20
HT6D420	44 mm	10	100	HT6D448	105 mm	5	20
HT6D424	51 mm	10	50	HT6D450	111 mm	5	10
HT6D426	54 mm	10	50	HT6D452	121 mm	5	10
HT6D429	57 mm	10	50	HT6D453	127 mm	5	10
HT6D431	60 mm	10	50	HT6D455	140 mm	5	10
HT6D433	64 mm	10	50	HT6D466	80 mm	5	50
HT6D435	67 mm	10	50				

DE Diamant Lochsägen EN Diamond hole saw FR couronne diamantée ES Broca de corona cabeza diamante HR Dijamantne krune za bušenje HU Gyémánt koronafúrófej RO Carote diamantate BG Диамантена боркорона

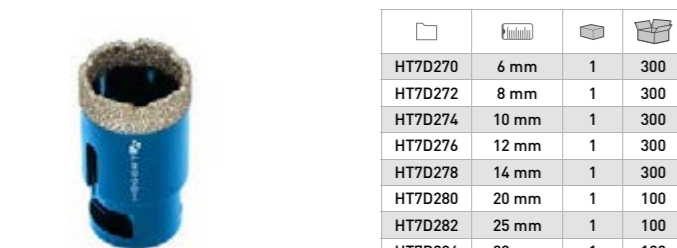

HT7D270	6 mm	1	300
HT7D272	8 mm	1	300
HT7D274	10 mm	1	300
HT7D276	12 mm	1	300
HT7D278	14 mm	1	300
HT7D280	20 mm	1	100
HT7D282	25 mm	1	100
HT7D284	28 mm	1	100
HT7D285	30 mm	1	100
HT7D286	35 mm	1	100
HT7D290	55 mm	1	50
HT7D294	68 mm	1	50
HT7D296	75 mm	1	50

DE Diamant Lochsägen EN Diamond hole saw FR Scie trépan diamant ES Broca de corona con cabeza de diamante HR Dijamantne krune za bušenje HU Gyémánt koronafúrófej RO Carote diamantate BG Диамантена боркорона

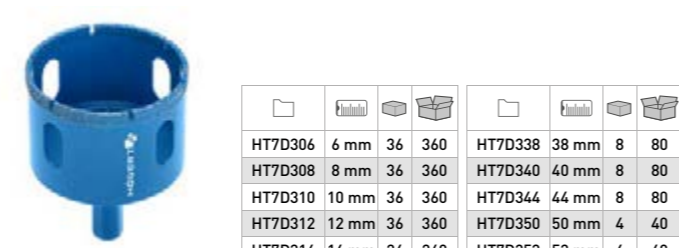

HT7D306	6 mm	36	360	HT7D338	38 mm	8	80
HT7D308	8 mm	36	360	HT7D340	40 mm	8	80
HT7D310	10 mm	36	360	HT7D344	44 mm	8	80
HT7D312	12 mm	36	360	HT7D350	50 mm	4	40
HT7D314	14 mm	24	240	HT7D353	53 mm	4	40
HT7D318	18 mm	24	240	HT7D360	60 mm	4	40
HT7D322	22 mm	24	240	HT7D365	65 mm	4	40
HT7D325	25 mm	12	120	HT7D367	67 mm	4	40
HT7D332	32 mm	8	80	HT7D373	73 mm	4	40
HT7D335	35 mm	8	80	HT7D383	83 mm	5	20

DE Diamanttrennscheiben unsegmentiert EN Diamond blade FR Disque diamant à jante continue ES Disco de diamante con borde continuo HR Dijamantni disk Super Thin, za univerzalne rezove HU Szuper-vékony gyémánt vágókorong, univerzális vágáshoz RO Disc super subtire pentru taieri universale BG Диамантен диск



HT6D701	115 mm	1,4 mm	1,4 mm	22,2 mm	50	100
HT6D702	125 mm	1,6 mm	7 mm	22,2 mm	50	100
HT6D703	180 mm	1,8 mm	7,5 mm	25,4 mm	1	50
HT6D706	230 mm	1,9 mm	7 mm	22,2 mm	1	25

DE Diamant-Trennscheibe EN Diamond blade FR Disque diamant extra-fin à jante continue ES Disco de diamante ultrafino con borde continuo HR Dijamantni disk Super Thin, za univerzalne rezove HU Szuper-vékony gyémánt vágókorong, univerzális vágáshoz RO Disc super subtire pentru taieri universale BG Диамантен диск



HT6D711	115 mm	1,3 mm	22,2 mm	50	100
HT6D712	125 mm	1,4 mm	22,2 mm	50	100
HT6D716	230 mm	2,0 mm	22,2 mm	1	25

DE Diamant-Trennscheibe EN Diamond blade FR Lame diamantée pour carreaux de céramique ES Disco de diamante HR Dijamantni disk, za rezanje pločica HU Gyémánt vágókorong, csempé vágáshoz RO Disc diamantat pentru taierea faietei BG Диамантен диск



EN 12236	SUPER SLIM	HT6D721	115 mm	1,2 mm	22,2 mm	max: 13,300 min <sup>-1</sup>	50	100
		HT6D722	125 mm	1,2 mm	22,2 mm	max: 12,000 min <sup>-1</sup>	50	100

DE Diamantklinge EN Diamond blade FR Disque diamanté ES Disco de corte de diamante HR Dijamantni disk, za rezanje betona i asfalta HU Gyémánt vágókorong, csempé vágáshoz RO Disc diamantat pentru taiere, segmentata BG Диамантен диск



EN 13236	LASER WELDED	CONCRETE ASPHALT	HT6D748	350 mm	3,2 mm	25,4 mm	1	10

DE Diamanttrennscheibe, Turbo EN Turbo saw blade FR Disque diamant, turbo ES Disco de diamante, turbo HR Dijamantna oštrica, turbo HU Gyémánt penge, turbó RO Lamă de diamant, turbo BG Диамантен диск, турбо



HT6D753	115 mm	50	100
HT6D754	125 mm	50	100
HT6D755	230 mm	1	25

DE Diamantscheibe zum Schleifen EN Diamond blade FR Disque diamant béton ES Disco de diamante para cemento HR Dijamantni disk, za brušenje betona HU Gyémánt vágókorong, beton vágáshoz RO Discuri diamantate pentru taierea betonului BG Диамантен диск



HT6D992	125 mm	5 mm	22,2 mm	1	25

DE Lasergeschweißte Diamantschneidsegmente EN Diamond blade FR Disque diamant Laser segmenté ES Disco de diamante segmentado mediante láser HR Dijamantni disk, za rezanje pločica HU Gyémánt vágókorong, csempé vágáshoz RO Disc diamantat pentru taierea faietei BG Диамантен диск



EN 12236	LASER WELDED	CONCRETE ASPHALT	HT6D742	125 mm	2,2 mm	22,2 mm	50	100
			HT6D746	230 mm	2,2 mm	22,2 mm	1	25

DE Segmentklinge EN Segmented saw blade FR Disque diamant segmenté ES Disco de diamante segmentado HR Lama de diamant segmentata HU Segmentirana dijamantna oštrica RO Ssegmentált gyémánt penge BG Диамантен диск със сегменти



HT6D750	115 mm	50	100
HT6D751	125 mm	50	100
HT6D752	230 mm	1	25

DE Ultradünnes Felgensägeblatt EN Ultrathin Rim Saw Blade FR Lame diamantée fine ES Disco de diamante fino HR Tanka dijamantna oštrica HU Vékony gyémánt penge RO Lamă subțire de diamant BG Диамантен диск, тънка



HT6D756	115 mm	50	100
HT6D757	125 mm	50	100
HT6D758	230 mm	1	25

DE Korundscheiben zum Metallschneiden EN Grinding wheel for metal and inox FR Disque à ébarber au corindon pour le métal ES Disco de corindón para desbarbado de metal HR Korundski disk za rezanje metala i inoxa HU Csiszoló korong, univerzális RO Disc pentru polizoare, universal BG Абразивни дискове за рязане на метал и inox



HT6D601	115 mm	1,0 mm	22,23 mm	1	25
HT6D602	125 mm	1,0 mm	22,23 mm	1	25
HT6D604	230 mm	1,9 mm	22,23 mm	1	25
HT6D616	125 mm	0,8 mm	22,23 mm	1	25

**DE** Korundscheibe für Nirostähle **EN** Grinding wheel for inox **FR** Disque à ébarber au corindon pour l'inox **ES** Disco de corindón para desbarbado de acero inoxidable **HR** Korundski disk za rezanje inoxa **HU** Csiszoló korong acélhoz **RO** Disc pentru polizoare, pentru oțel **BG** Абразивни дискове за рязане на inox



**INOX**  $C_{max}$  12,250 /min  $V_{max}$  80 m/s

**FLAT**

Code	Ø	Thickness	Length	Quantity	Pack
HT6D606	125 mm	1,0 mm	22,23 mm	1	25

**DE** Metall-Schleif-scheibe **EN** Metal grinding discs **FR** Disque de polissage pour métaux **ES** Disco cortador para metal **HR** Metalni disk za brušenje **HU** Vágókorong fémhez **RO** Disc pt. șlefuit metal **BG** Диск за шлайфане на метал



**STEEL**  $C_{max}$  13.300 min<sup>-1</sup>  $V_{max}$  80 m/s

**DEPRESSED**

Code	Ø	Thickness	Length	Quantity	Pack
HT6D635	115 mm	6,0 mm	22,23 mm	1	100
HT6D636	125 mm	6,0 mm	22,23 mm	1	100
HT6D638	230 mm	6,8 mm	22,23 mm	1	40

**DE** Fasenfase **EN** Screw cup cutter **FR** Chanfrein à fil **ES** Chaflán de rosca **HR** Posjekotina navoja **HU** Szál letörés **RO** Șanț de fir **BG** Резба шамфер



**1/4" HEX** **TCT** 1,8 mm

Code	Ø	Length	Quantity	Pack
HT3B610	1/4" HEX	3-19 mm	10	80

**DE** Gebogene Holzschnitzscheibe **EN** Curved wood carven disc **FR** Disque sculpté en bois incurvé **ES** Disco tallado de madera curvado **HR** Zakrivljeni drveni rezani disk **HU** Ívelt fa faragott tárcsa **RO** Disc de carven din lemn curbat **BG** Извит дърворезбен диск



$\varnothing$  125 mm **CURVED**  $C_{max}$  12,200 min<sup>-1</sup>  $C_{max}$  80 m/sek

Code	Length	Quantity	Pack
HT8B235	125 mm	25	100

**DE** Trennscheibe für Metall Inox **EN** Metal and inox cutting discs **FR** Lame de scie pour métaux **ES** Disco cortador para metal **HR** Metalni disk za rezanje **HU** Vágókorong fémhez **RO** Disc debitat metale **BG** Диск за рязане на метал и inox



**STEEL INOX**  $C_{max}$  12,250 /min  $V_{max}$  80 m/s

**FLAT**

Code	Ø	Thickness	Length	Quantity	Pack
HT6D630	115 mm	1,0 mm	22,23 mm	1	400
HT6D631	125 mm	1,0 mm	22,23 mm	1	400
HT6D632	125 mm	1,6 mm	22,23 mm	1	400
HT6D633	180 mm	1,6 mm	22,23 mm	1	200
HT6D634	230 mm	1,9 mm	22,23 mm	1	120

**DE** Korundscheibe zum Kupfer **EN** Grinding wheel for non-ferrous metal **FR** Disque à ébarber au corindon pour alu et métaux non ferreux **ES** Disco de corindón para desbarbado de aluminio y metales no férricos **HR** Korundski disk za rezanje bakra, aluminija i obojenih metala **HU** Csiszoló korong rézhez, alumíniumhoz, vasmentes fémekhez **RO** Disc pentru polizoare, pentru cupru, aluminiu si metale neferoase **BG** Диск за цветни метали



**Cu Al**  $C_{max}$  12,250 /min  $V_{max}$  80 m/s

Code	Ø	Thickness	Length	Quantity	Pack
HT6D640	125 mm	1,6 mm	22,23 mm	1	25

**DE** Flache Holzschnitzscheibe **EN** Flat wood carven disc **FR** Disque plat en acier, scierie **ES** Lame terasketas, saeveski **HR** Ravni čelični disk, pilana **HU** Lapos acéllemez, fűrésztelep **RO** Disc plat din oțel, fabrică de cherestea **BG** Плосък стоманен диск, дъскорезница



$\varnothing$  125 mm **FLAT**  $C_{max}$  12,200 min<sup>-1</sup>  $C_{max}$  80 m/sek

Code	Length	Quantity	Pack
HT8B230	125 mm	25	100

**DE** Stichsägenblätter für schnellen Schnitt **EN** Jig saw blades, fast cut **FR** Pack de lames de scie sauteuse pour bois **ES** Paquete de hojas de sierra de calar para madera **HR** Listovi za ubodne pile, za brze rezove **HU** Dekopir fűrészlap, gyorsvágó **RO** Panze fierastrăie verticale, taiere rapida **BG** Нож за прободен трион за дързо рязане



x2 **CrV** **FAST CUT** **6 TPI** **soft**

**T-type** **min** 5 mm **max** 60 mm

Code	Length	Quantity	Pack
HT6D650-2	75 x 100 mm	25	250



DE Sticksägeblatt für schnelle Holzschnitte EN Jig saw blade, fast wood cut FR Lame de scie sauteuse, pour des coupes rapides du bois ES List ubodne pile za brzo rezanje drva HR List ubodne pile za brzo rezanje drva HU Dekopírfűrész fűrészlap fa gyors vágásához RO Pânză de fierăstrău pentru tăierea rapidă a lemnului BG Нож за прободен трион за сухо дърво



Festool, De Walt, Kress, AEG, Black & Decker, Bosch, Makita, Hitach, Hilti, Milwaukee

SK5	x5	FAST CUT	STRAIGHT CUT
6 TPI	T-type	teeth shape	soft
min 4mm	max 30mm		

HT6D651	75x100 mm	100	400
---------	-----------	-----	-----

DE Sticksägeblatt für schnelle Holzschnitte EN Jig saw blade, fast wood cut FR Lame de scie sauteuse, pour des coupes rapides du bois ES List ubodne pile za brzo rezanje drva HR List ubodne pile za brzo rezanje drva HU Dekopírfűrész fűrészlap fa gyors vágásához RO Pânză de fierăstrău pentru tăierea rapidă a lemnului BG Нож за прободен трион за сухо дърво



Festool, De Walt, Kress, AEG, Black & Decker, Bosch, Makita, Hitach, Hilti, Milwaukee

HCS 65Mn	x5	FAST CUT	9 TPI
T-type	teeth shape	soft	
min 4mm	max 30mm		

HT6D653	100 x 126 mm	100	400
---------	--------------	-----	-----

DE Sticksägenblätter für präzisen Kurvenschnitt EN Jig saw blades, precision curved cut FR Pack de lames de scies sauteuses ES Paquete de hojas de sierra de calar HR Listovi za ubodne pile, za precizne krivolinijske rezove HU Dekopírfűrész fűrészlap, preciz és ívelt vágásához RO Panze fierăstraie verticale, taiere rapidă și de precizie BG Нож за прободен трион за прецизно рязане на криво



Festool, De Walt, Kress, AEG, Black & Decker, Bosch, Makita, Hitach, Hilti, Milwaukee

x2	CrV	CLEAN CUT	CURVE CUT	T-type
10 TPI	min 4mm	max 30mm	soft	hard

HT6D663-2	75 x 100 mm	25	250
-----------	-------------	----	-----

DE Sticksägeblatt für saubere Holzschnitte EN Jig saw blade, clean wood cut FR Lame de scie sauteuse, pour des coupes nettes du bois ES List ubodne pile za čiste rezove u drvu HR List ubodne pile za čiste rezove u drvu HU Dekopírfűrész fűrészlap fa tiszta vágásához RO Pânză de fierăstrău pentru tăierea curată a lemnului BG Нож за прободен трион за рязане на дърво

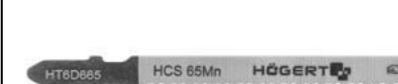

Festool, De Walt, Kress, AEG, Black & Decker, Bosch, Makita, Hitach, Hilti, Milwaukee

HCS 65Mn	CLEAN CUT	x5	10 TPI
T-type	teeth shape	soft	
min 4mm	max 30mm		

HT6D665	75 x 100 mm	100	400
---------	-------------	-----	-----

DE Sticksägenblätter für schnellen Schnitt EN Jig saw blades, fast cut FR Pack de lames de scie sauteuse pour bois ES Paquete de hojas de sierra de calar para madera HR Listovi za ubodne pile, za brzo rezove HU Dekopírfűrész fűrészlap, gyorsvágó RO Panze fierăstraie verticale, taiere rapidă BG Нож за прободен трион за дърво рязане



Festool, De Walt, Kress, AEG, Black & Decker, Bosch, Makita, Hitach, Hilti, Milwaukee

x2	CrV	FAST CUT	6 TPI
T-type	min 8mm	max 100mm	soft
hard			

HT6D654-2	110 x 132 mm	25	250
-----------	--------------	----	-----

DE Sticksägenblätter für sauberen Schnitt EN Jig saw blades, clean cut FR Pack de lames de scie sauteuse pour bois ES Paquete de hojas de sierra de calar para madera HR Listovi za ubodne pile, za čiste rezove HU Dekopírfűrész fűrészlap, sima vágásfelülettel vágó RO Panze fierăstraie verticale, taiere curată BG Нож за прободен трион за дърво рязане



Festool, De Walt, Kress, AEG, Black & Decker, Bosch, Makita, Hitach, Hilti, Milwaukee

x2	CrV	CLEAN CUT	10 TPI
T-type	min 3mm	max 40mm	soft

HT6D656-2	75 x 100 mm	25	250
-----------	-------------	----	-----

DE Sticksägeblatt für saubere Holzschnitte EN Jig saw blade, clean wood cut FR Lame de scie sauteuse, pour des coupes nettes du bois ES List ubodne pile za čiste rezove u drvu HR List ubodne pile za čiste rezove u drvu HU Dekopírfűrész fűrészlap fa tiszta vágásához RO Pânză de fierăstrău pentru tăierea curată a lemnului BG Нож за прободен трион за рязане на дърво



Festool, De Walt, Kress, AEG, Black & Decker, Bosch, Makita, Hitach, Hilti, Milwaukee

HCS 65Mn	CLEAN CUT	x5	10 TPI	T-type
teeth shape	soft			
min 4mm	max 30mm			

HT6D666	75 x 100 mm	100	400
---------	-------------	-----	-----

DE Sticksägeblatt für saubere Holzschnitte EN Jig saw blade, clean wood cut FR Lame de scie sauteuse, pour des coupes nettes du bois ES List ubodne pile za čiste rezove u drvu HR List ubodne pile za čiste rezove u drvu HU Dekopírfűrész fűrészlap fa tiszta vágásához RO Pânză de fierăstrău pentru tăierea curată a lemnului BG Нож за прободен трион за рязане на дърво



Festool, De Walt, Kress, AEG, Black & Decker, Bosch, Makita, Hitach, Hilti, Milwaukee

HCS 65Mn	CLEAN CUT	x5	6 TPI
T-type	teeth shape	soft	
min 4mm	max 30mm		

HT6D667	75 x 100 mm	100	400
---------	-------------	-----	-----

DE Sticksägeblatt für gebogene Holzschnitte EN Jig saw blade, curved wood cut FR Lame de scie sauteuse, pour des coupes courbes du bois ES List ubodne pile za krivolinijsko rezanje drva HR List ubodne pile za krivolinijsko rezanje drva HU Dekopírfűrész fűrészlap fa íves vonalú vágásához RO Pânză de fierăstrău pentru tăierea curbată a lemnului BG Нож за прободен трион за криво рязане на дърво



Festool, De Walt, Kress, AEG, Black & Decker, Bosch, Makita, Hitach, Hilti, Milwaukee

HCS 65Mn	CURVE CUT	x5	12 TPI
T-type	teeth shape	soft	
min 1.5mm	max 3.5mm		

HT6D657	50 x 76 mm	100	400
---------	------------	-----	-----

DE Sticksägeblatt für schnelle und gebogene Holzschnitte EN Jig saw blade, fast curved wood cut FR Lame de scie sauteuse, pour des coupes courbes rapides du bois ES List ubodne pile za brzo krivolinijsko rezanje drvu HR List ubodne pile za brzo krivolinijsko rezanje drvu HU Dekopírfűrész fűrészlap fa gyors íves vonalú vágásához RO Pânză de fierăstrău pentru tăierea curbată rapidă a lemnului BG Нож за прободен трион за бързо криво рязане на дърво



Festool, De Walt, Kress, AEG, Black & Decker, Bosch, Makita, Hitach, Hilti, Milwaukee

HCS 65Mn	FAST CUT	CURVE CUT	x5	6 TPI
T-type	teeth shape	soft		
min 3mm	max 40mm			

HT6D659	75 x 100 mm	100	400
---------	-------------	-----	-----

DE Sticksägeblatt für saubere Holzschnitte EN Jig saw blade, clean wood cut FR Lame de scie sauteuse, pour des coupes nettes du bois ES List ubodne pile za čiste rezove u drvu HR List ubodne pile za čiste rezove u drvu HU Dekopírfűrész fűrészlap fa tiszta vágásához RO Pânză de fierăstrău pentru tăierea curată a lemnului BG Нож за прободен трион за рязане на дърво



Festool, De Walt, Kress, AEG, Black & Decker, Bosch, Makita, Hitach, Hilti, Milwaukee

HCS 65Mn	CLEAN CUT	x5	8 TPI
T-type	teeth shape	soft	
min 3mm	max 60mm		

HT6D668	90 x 116 mm	100	400
---------	-------------	-----	-----

DE Sticksägenblätter zur optimalen Verarbeitung von Metall EN Jig saw blades set FR Pack de lames de scie sauteuse pour bois et métal ES Paquete de hojas de sierra de calar para madera y metal HR Set listova za ubodne pile HU Dekopírfűrész fűrészlap készlet RO Set de panze fierăstraie verticale BG Комплект ножчета за прободен трион



Festool, De Walt, Kress, AEG, Black & Decker, Bosch, Makita, Hitach, Hilti, Milwaukee

WOOD x3	METAL x2	FAST CUT	CLEAN CUT
CURVE CUT	T-type		

	mm	mm	mm	TPI	
HT6D690	HT6D650	75	100	8-60	6
	HT6D660	75	100	3-60	12
	HT6D668	50	75	2-20	20
	HT6D670	50	75	1.5-3	21
HT6D674	50	75	3-6	12	

DE Sticksägeblatt für saubere Holzschnitte EN Jig saw blades, clean cut FR Pack de lames de scie sauteuse pour bois ES Paquete de hojas de sierra de calar para madera HR Listovi za ubodne pile, za čiste ravlinijske rezove HU Dekopírfűrészlap, sima vágásfelületű vágással egyenes vágásához RO Panze fierăstraie verticale, taiere curată în linie dreaptă BG Лист за ръчна ножовка за прецизно рязане на право



Festool, De Walt, Kress, AEG, Black & Decker, Bosch, Makita, Hitach, Hilti, Milwaukee

x2	CrV	CLEAN CUT	T-type
12 TPI	min 3mm	max 60mm	soft

HT6D660-2	75 x 100 mm	25	250
-----------	-------------	----	-----

DE Sticksägenblätter für sauberen Kurvenschnitt EN Jig saw blades, clean curved cut FR Pack de lames de scie sauteuse pour bois ES Paquete de hojas de sierra de calar para madera HR Listovi za ubodne pile, za čiste krivolinijske rezove HU Dekopírfűrészlap, sima vágásfelületű vágással ívelt vágásokhoz RO Panze fierăstraie verticale, taiere de precizie în linie curbata BG Нож за прободен трион за прецизно рязане на криво



Festool, De Walt, Kress, AEG, Black & Decker, Bosch, Makita, Hitach, Hilti, Milwaukee

x2	CrV	CLEAN CUT	CURVE CUT
T-type	12 TPI	min 3mm	max 60mm
soft			

HT6D661-2	75 x 100 mm	25	250
-----------	-------------	----	-----

DE Sticksägenblätter zum Schneiden enger Kurven EN Jig saw blades, extreme curved cut FR Pack de lames de scie sauteuse pour bois ES Paquete de hojas de sierra de calar para madera HR Listovi za ubodne pile za rezanje kroz oštre lukove HU Dekopírfűrészlap 115 mm, rendkívül ívelt vágásokhoz RO Panze fierăstraie verticale 115 mm, taiere în linie extrem de curbata BG Нож за прободен трион за право рязане



Festool, De Walt, Kress, AEG, Black & Decker, Bosch, Makita, Hitach, Hilti, Milwaukee

x2	CrV	EXTREME CURVE CUT	8-11 TPI	T-type
min 3mm	max 80mm	soft	hard	

HT6D682-2	95 x 115 mm	25	250
-----------	-------------	----	-----

DE Sticksägeblatt für Metallschnitte EN Jig saw blade, metal cut FR Lame de scie sauteuse, pour couper le métal ES List ubodne pile za rezanje metala HR List ubodne pile za rezanje metala HU Dekopírfűrész fűrészlap fém vágásához RO Pânză de fierăstrău pentru tăierea metalelor BG Нож за прободен трион за метал



Festool, De Walt, Kress, AEG, Black & Decker, Bosch, Makita, Hitach, Hilti, Milwaukee

HSS	STRAIGHT CUT	x5	12 TPI
T-type	teeth shape		

HT6D671	50 x 76 mm	100	400
---------	------------	-----	-----

DE Stichtsägeblatt für Metallschnitte EN Jig saw blade, metal cut FR Lame de scie sauteuse, pour couper le métal ES List ubodne pile za rezanje metala HR List ubodne pile za rezanje metala HU Dekopírfűrész fűrészlap fém vágásához RO Pânză de fierăstrău pentru tăierea metalelor BG Нож за прободен трион за метал



Festool, De Walt, Kress, AEG, Black & Decker, Bosch, Makita, Hitach, Hilti, Milwaukee

HSS STRAIGHT CUT x5 T-type

teeth shape

HT6D672	75 x 100 mm	100	400
---------	-------------	-----	-----

DE Stichtsägeblatt für Metallschnitte EN Jig saw blade, metal cut FR Lame de scie sauteuse, pour couper le métal ES List ubodne pile za rezanje metala HR List ubodne pile za rezanje metala HU Dekopírfűrész fűrészlap fém vágásához RO Pânză de fierăstrău pentru tăierea metalelor BG Нож за прободен трион за метал



Festool, De Walt, Kress, AEG, Black & Decker, Bosch, Makita, Hitach, Hilti, Milwaukee

HSS STRAIGHT CUT x5 21 TPI

T-type teeth shape

HT6D673	110 x 132 mm	100	400
---------	--------------	-----	-----

DE Stichtsägeblätter für universelle Verwendung EN Jig saw blades, universal in use FR Pack de lames de scie sauteuse multimatériaux ES Paquete de 2 hojas de sierra de calar para multimaterial HR Listove za ubodne pile, univerzalna primjena HU Dekopír fűrészlap 132 mm, univerzális felhasználásra RO Panze fierăstraie verticale 132 mm, taiere pentru scopuri universale BG Универсален нож за прободен трион



x2 BiMetal MULTI 10-14 TPI T-type

min 3mm max 100mm METAL AI Cu, Ni Zn

soft hard

HT6D680-2	110 x 132 mm	25	250
-----------	--------------	----	-----

DE Säbelsägeblätter EN Reciprocating saw blade FR Lame de scie alternative ES Hoja para sierra de sable HR List za sabljastu pilu HU Univerzális kardfűrész lap RO Panze fierăstraie sabie BG Лист за ръчен трион



BiMetal 14 TPI STEEL

HT6D901	130 mm 150 mm 0,9 mm	20	100
---------	----------------------------	----	-----

DE Säbelsägeblätter für Stahl und Inox EN Reciprocating saw blade FR Lame de scie alternative ES Hoja para sierra metal y acero inoxidable para sierras de calar HR List za sabljastu pilu HU Univerzális kardfűrész lap RO Panze fierăstraie sabie BG Лист за ръчен трион



BiMetal 14 TPI STEEL

HT6D902	280 mm 300 mm 0,9 mm	20	100
---------	----------------------------	----	-----

DE Säbelsägeblätter für Holz EN Reciprocating saw blade FR Lame de scie alternative ES Hoja para sierra de sable HR List za sabljastu pilu HU Univerzális kardfűrész lap RO Panze fierăstraie sabie BG Лист за ръчен трион



BiMetal 10-14 TPI METAL AI

soft hard

HT6D904	210 mm 230 mm 0,9 mm	20	100
---------	----------------------------	----	-----

DE Universal-Säbelsägeblätter EN Reciprocating saw blade FR Lame de scie alternative ES Hoja para sierra de sable HR List za sabljastu pilu HU Univerzális kardfűrész lap RO Panze fierăstraie sabie BG Лист за ръчен трион



BiMetal 6 TPI METAL

soft hard

HT6D916	210 mm 230 mm 1,57 mm	20	100
---------	-----------------------------	----	-----

DE Universal-Säbelsägeblätter EN Reciprocating saw blade FR Lame de scie alternative ES Hoja para sierra de sable HR List za sabljastu pilu HU Univerzális kardfűrész lap RO Panze fierăstraie sabie BG Лист за ръчен трион



BiMetal 8% COBALT 6 TPI

METAL soft hard

HT6D923	130 mm 150 mm 0,9 mm	20	200
---------	----------------------------	----	-----

DE Fächerschleifmop mit Schaft EN Flap wheel with shaft FR Roue à lamelles abrasives sur tiges ES Rueda de aleta con eje HR Lepezasti brusni kolut HU Csiszolópapír korong fűrégpéhez RO Roata slefuire BG Шлайф барабан с опашка



HT8D001	40x20x6 mm	G40	10	250
HT8D002		G60	10	250
HT8D003		G80	10	250
HT8D004		G100	10	250
HT8D005		G120	10	250
HT8D006		G150	10	250
HT8D010	60x30x6 mm	G40	10	250
HT8D011		G60	10	250
HT8D012		G80	10	250
HT8D013		G100	10	250
HT8D014		G120	10	250
HT8D015		G150	10	250
HT8D020	80x40x6 mm	G40	5	100
HT8D021		G60	5	100
HT8D022		G80	5	100
HT8D023		G100	5	100
HT8D024		G120	5	100
HT8D025		G150	5	100

METAL max 18.000 min<sup>-1</sup>

DE Fächerschleifscheibe - Gerade EN Flap disc depressed FR Disque à lamelles abrasives ES Disco de solapa deprimido HR Lamelni brusni disk HU Csiszoló korong RO Discuri abrazive BG Ламелни шайби



HT8D050	ø125 mm	22,4 mm	G36	10	100
HT8D051	ø125 mm	22,4 mm	G40	10	100
HT8D052	ø125 mm	22,4 mm	G60	10	100
HT8D053	ø125 mm	22,4 mm	G80	10	100
HT8D054	ø125 mm	22,4 mm	G100	10	100
HT8D055	ø125 mm	22,4 mm	G120	10	100

METAL max 12.200 min<sup>-1</sup>

DE Schleifpapier zum Gummiteller EN Abrasive disc FR Disque abrasif ES Disco abrasivo HR Brusni papir okrugli HU Csiszolópapír, kerek RO Foai slefuire BG Фиър диск



HT8D100	G36	50	200
HT8D101	G40	50	200
HT8D102	G60	50	200
HT8D103	G80	50	200
HT8D104	G100	50	200
HT8D105	G120	50	200
HT8D106	G150	50	200
HT8D107	G180	50	200
HT8D108	G220	50	200

METAL WOOD 125 mm x5 VELCRO

DE Schleifpapier zum Gummiteller mit lochen EN Abrasive disc FR Disque abrasif trous ES Disco abrasivo con agujeros HR Brusni papir, okrugli, s rupicama HU Csiszolópapír sarokcsiszolóhoz, lyukacsos RO Foai slefuire gaurita BG Фиър диск



HT8D120	G40	50	200
HT8D121	G60	50	200
HT8D122	G80	50	200
HT8D123	G100	50	200
HT8D124	G120	50	200
HT8D125	G150	50	200
HT8D126	G180	50	200
HT8D127	G220	50	200

METAL WOOD 125 mm x5 VELCRO

DE Schleifpapier zum Gummiteller mit lochen EN Abrasive disc FR Disque abrasif trous ES Disco abrasivo con agujeros HR Brusni papir, okrugli, s rupicama HU Csiszolópapír sarokcsiszolóhoz, lyukacsos RO Foai slefuire gaurita BG Фиър диск



HT8D130	G40	10	160
HT8D131	G60	10	160
HT8D132	G80	10	160
HT8D133	G100	10	160
HT8D134	G120	10	160
HT8D135	G150	10	160
HT8D136	G180	10	160
HT8D137	G220	10	160
HT8D138	G320	10	160

METAL WOOD 150 mm x5 VELCRO 15 holes

DE Schleifpapier zum Gummiteller mit lochen EN Abrasive disc FR Disque abrasif trous ES Disco abrasivo con agujeros HR Brusni papir, okrugli, s rupicama HU Csiszolópapír sarokcsiszolóhoz, lyukacsos RO Foai slefuire gaurita BG Фиър диск



HT8D140	G60	10	160
HT8D141	G80	10	160
HT8D142	G100	10	160
HT8D143	G120	10	160
HT8D144	G150	10	160
HT8D145	G180	10	160
HT8D146	G220	10	160
HT8D147	G240	10	160
HT8D148	G280	10	160
HT8D149	G320	10	160
HT8D150	G400	10	160

PAINT FILLER 150 mm x5 VELCRO 15 holes

DE Schlieflvlies EN Abrasive cloth FR Tampons abrasifs en fibre non tissée ES No Tejido Paño Abrasivo Almohadillas HR Netkani abrazivni jastučići HU Rostalapú Kézi Csiszolólapok-Fekete RO Tamponae abrazive din fibră nețesută BG Почистваща шайба



HT8D200	G400	x3	150x200 mm
---------	------	----	------------

DE Vlies-Schleifscheibe EN Stripping disc FR Disque abrasif en fibre non-tissée ES Muela abrasiva no tejido para eliminación de óxido HR Poly grubi diskovi za čišćenje hrde HU Rostos rozsdáeltávolító csiszoló RO Roată de șlefuit nețesută pentru îndepărtarea ruginii BG Почистваща шайба на ръжда



HT8D190	METAL/INOX/WOOD/PLASTIC	125 mm	22,2 mm	max 12500 min <sup>-1</sup>	80 m/s
---------	-------------------------	--------	---------	-----------------------------	--------

**DE** Vlies-Schleifscheibe **EN** Stripping disc **FR** Disque abrasif en fibre non-tissé **ES** Muela abrasiva no tejido para eliminación de óxido **HR** Poly grubi diskovi za čišćenje hrđe **HU** Rostos rozsdaeltvoltító csiszoló **RO** Roată de șlefuit nețesută pentru îndepărtarea ruginii **BG** Почистваща шайба на ръжда



METAL/ INOX/ WOOD/ PLASTIC	100 mm	6 mm	C <sub>max</sub> 4500 min <sup>-1</sup>	80 m/s
-------------------------------------	--------	------	--	-----------

HT8D195	10	40
---------	----	----

**DE** Klett-Schleifteller mit Schaft **EN** Rubber backing pad **FR** Disque caoutchouc avec velcro **ES** Disco de goma para ancl con mandril **HR** Držac brusnog papira čičak **HU** Euro lemez élhez, tapadókoronggal **RO** Euro disc cu scai pt. polizor unghiular **BG** Подложка за фибър диск с велкро



125 mm	M14	7 mm	C <sub>max</sub> 10000 min <sup>-1</sup>
HOOK FASTENER			

HT8D210	10	40
---------	----	----

**DE** Topfbürste mit Schaft **EN** End brush with arbor **FR** Brosse conique tige **ES** Cepillo redondo con vástago **HR** Čeona četka s držačem **HU** Drótkorong, végkefével **RO** Perii de sarma tip oala pentru masini de gaurit **BG** Чашковидна телена четка с опашка



75 mm	0.3 mm	BRASS WIRE	MAX 4500 RPM
-------	--------	---------------	--------------------

HT7D702	1	12
---------	---	----

**DE** Topfbürste mit Schaft **EN** End brush with arbor **FR** Brosse conique tige **ES** Cepillo redondo con vástago **HR** Čeona četka s držačem **HU** Drótkorong, végkefével **RO** Perii de sarma tip oala pentru masini de gaurit **BG** Чашковидна телена четка с опашка



75 mm	0.3 mm	STAINLESS STEEL WIRE	MAX 4500 RPM
-------	--------	----------------------------	--------------------

HT7D704	1	12
---------	---	----

**DE** Topfbürste mit Schaft **EN** End brush with arbor **FR** Brosse conique tige **ES** Cepillo redondo con vástago **HR** Čeona četka s držačem **HU** Drótkorong, végkefével **RO** Perii de sarma tip oala pentru masini de gaurit **BG** Чашковидна телена четка с опашка



75 mm	0.5 mm	STAINLESS STEEL WIRE	MAX 12 500 RPM
-------	--------	----------------------------	----------------------

HT7D706	1	12
---------	---	----

**DE** Rundbürste mit Schaft **EN** Wheel brush with arbor **FR** Brosse circulaire tige **ES** Cepillo de disco con vástago **HR** Cirkularna četka s držačem **HU** Drótkorong, oldalkefével **RO** Perii de sarma tip disc pentru masini de maurit **BG** Дисквидна телена четка с опашка



100 mm	0.3 mm	BRASS WIRE	MAX 4500 RPM
--------	--------	---------------	--------------------

HT7D712	1	12
---------	---	----

**DE** Rundbürste mit Schaft **EN** Wheel brush with arbor **FR** Brosse circulaire tige **ES** Cepillo de disco con vástago **HR** Cirkularna četka s držačem **HU** Drótkorong, oldalkefével **RO** Perii de sarma tip disc pentru masini de maurit **BG** Дисквидна телена четка с опашка



100 mm	0.3 mm	STEEL WIRE
--------	--------	---------------

HT7D713	1	12
---------	---	----

**DE** Rundbürste mit Schaft **EN** Wheel brush with arbor **FR** Brosse circulaire tige **ES** Cepillo de disco con vástago **HR** Cirkularna četka s držačem **HU** Drótkorong, oldalkefével **RO** Perii de sarma tip disc pentru masini de gaurit **BG** Дисквидна телена четка с опашка



75 mm	0.5 mm	STEEL WIRE
-------	--------	---------------

HT7D716	1	12
---------	---	----

DE Kegelbürste mit Gewinde EN Knot wheel brush FR Brosse circulaire filetage ES Cepillo de disco con rosca HR Cirkularna četka s navojem HU Drótkorong sarokcsiszolóhoz, oldalkefével RO Perii de sarma conica pentru polizoare unghiulare BG Дисквидна телена четка



HT7D722	1	6
---------	---	---

DE Kegelbürste mit Gewinde EN Knot wheel brush FR Brosse circulaire filetage ES Cepillo de disco con rosca HR Cirkularna četka s navojem HU Drótkorong sarokcsiszolóhoz, oldalkefével RO Perii de sarma rasucita pentru polizoare unghiulare BG Дисквидна телена четка



HT7D724	1	6
---------	---	---

DE Kegelbürste mit Gewinde EN Knot wheel brush FR Brosse circulaire filetage ES Cepillo de disco con rosca HR Čeona četka z navojem HU Drótkorong sarokcsiszolóhoz, végkefével RO Perii de sarma tip almit pentru polizoare unghiulare BG Дисквидна телена четка



HT7D732	1	4
---------	---	---

DE Kegelbürste mit Gewinde EN Knot wheel brush FR Brosse circulaire filetage ES Cepillo de disco con rosca HR Čeona četka z navojem HU Drótkorong sarokcsiszolóhoz, végkefével RO Perii de sarma rasucita pentru polizoare unghiulare BG Дисквидна телена четка

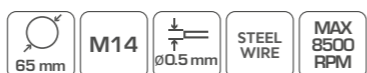

HT7D734	1	6
---------	---	---

DE Kegelbürste mit Gewinde EN Knot wheel brush FR Brosse circulaire filetage ES Cepillo de disco con rosca HR Čeona četka z navojem HU Drótkorong sarokcsiszolóhoz, végkefével RO Perii de sarma rasucita pentru polizoare unghiulare BG Дисквидна телена четка

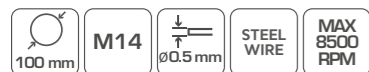

HT7D738	1	4
---------	---	---

DE Sägeblatt EN Circular saw blade FR Lame de scie circulaire ES Hoja de sierra circular HR List kružne pile HU Körfűrészlap RO Pânză de ferăstrău circular BG Диск за циркуляр, за рязане на дърво



	Ø	T	⊖	⊞
HT6D773	160	18T	1	50
HT6D774	160	30T	1	50
HT6D775	160	48T	1	50
HT6D776	165	18T	1	50
HT6D777	165	30T	1	50
HT6D778	185	24T	1	50
HT6D779	185	36T	1	50
HT6D780	185	40T	1	50
HT6D781	185	48T	1	50
HT6D782	185	60T	1	50
HT6D783	190	24T	1	50
HT6D784	190	40T	1	50
HT6D785	190	50T	1	50
HT6D786	216	36T	1	50
HT6D787	216	48T	1	50
HT6D788	216	60T	1	50
HT6D789	255	40T	1	50
HT6D790	250	40T	1	50

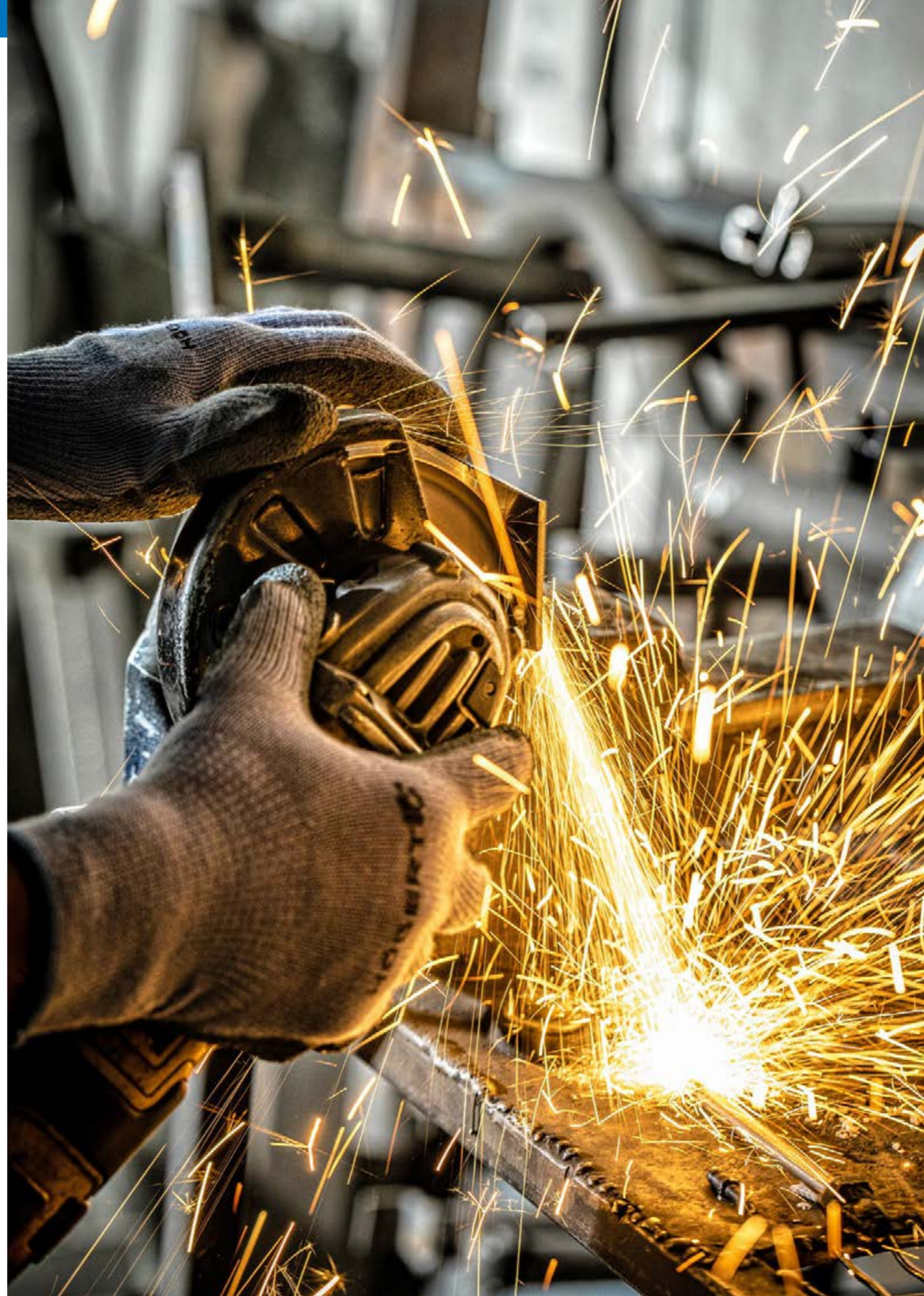

**HÖGERT**  
technik

DE Anschlusswerkzeuge  
EN Joining Tools  
FR Outils De Connexion  
ES Herramientas De Unión  
HR Alati Za Spajanje  
HU Csatlakoztató Eszközök  
RO Instrumente De Îmbinare  
BG Свързващи Инструменти





DE Schmelzkleberpistole EN Hot glue gun FR Pistolet à colle ES Pistola para pegamento HR Pištolj za ljepljivo HU Rudas ragasztópisztoly RO Pistol de lipire BG Пистолет за лепене



∅7 mm	20 W	230 V 50 Hz	10-20 g/min	CERAMIC HEATER	METAL TIP	HT2C101	220 g	12	48
-------	------	-------------	-------------	----------------	-----------	---------	-------	----	----

DE Schmelzkleberpistole EN Hot glue gun FR Pistolet à colle ES Pistola para pegamento HR Pištolj za ljepljivo HU Rudas ragasztópisztoly RO Pistol de lipire BG Пистолет за лепене



∅11.2 mm	100 W	230 V 50 Hz	13-30 g/min	CERAMIC HEATER	METAL TIP	HT2C107	400 g	10	30
----------	-------	-------------	-------------	----------------	-----------	---------	-------	----	----

DE Schmelzkleberpistole EN Hot glue gun FR Pistolet à colle ES Pistola de pegamento HR Pištolj za ljepljivo HU Rudas ragasztópisztoly RO Pistol de lipire BG Пистолет за лепене



∅11.2 mm	20(78)W	230 V 50 Hz	12-18 g/min			HT2C108	270 g	12	48
----------	---------	-------------	-------------	--	--	---------	-------	----	----

DE Leimpatronen EN Glue sticks FR Baton de colle ES Recambio para pistola de pegamento HR Kartuše s ljepljivom HU Ragasztórúd ragasztópisztolyhoz RO Lipici pentru pistol de lipire BG Силиконови пръчки за пистолет



∅11.2 mm	15PC	100-200°C				HT2C131	200 mm	1 kg	1	25
----------	------	-----------	--	--	--	---------	--------	------	---	----

DE Leimpatronen EN Glue sticks FR Pack de bâtons de colle transparents ES Paquete de barras de pegamento transparente HR Kartuše s ljepljivom HU Ragasztórúd ragasztópisztolyhoz RO Lipici pentru pistol de lipire BG Силиконови пръчки за пистолет



∅11.2 mm	15PC	120-150°C				HT2C135	300 mm	5 kg	1	4
----------	------	-----------	--	--	--	---------	--------	------	---	---

DE Leimpatronen EN Glue sticks FR Pack de bâtons de colle transparents ES Paquete de 12 barras de pegamento transparente HR Kartuše s ljepljivom HU Ragasztórúd ragasztópisztolyhoz RO Lipici pentru pistol de lipire BG Силиконови пръчки за пистолет



x12	∅11.2 mm	18PC	120-150°C			HT2C137	250 mm	540 g	10	40
-----	----------	------	-----------	--	--	---------	--------	-------	----	----

DE Leimpatronen EN Glue sticks FR Baton de colle ES Pack de barras de pegamento HR Kartuše s ljepljivom HU Ragasztórúd ragasztópisztolyhoz RO Lipici pentru pistol de lipire BG Силиконови пръчки за пистолет



x12	∅11.2 mm	BLACK	18PC	120-150°C		HT2C138	250 mm	540 g	10	40
-----	----------	-------	------	-----------	--	---------	--------	-------	----	----

DE Leimpatronen EN Glue sticks FR Baton de colle ES Recambio para pistola de pegamento HR Kartuše s ljepljivom HU Ragasztórúd ragasztópisztolyhoz RO Lipici pentru pistol de lipire BG Силиконови пръчки за пистолет



x10	∅7 mm	15PC	100-200°C			HT2C141	200 mm	110 g	1	150
-----	-------	------	-----------	--	--	---------	--------	-------	---	-----

DE Handtacker EN Staple gun FR Pistolet agrafeur ES Grapadora industrial HR Ručna klamera HU Tűzőgép RO Capsator BG Ръчен телбод/такер



TYPE J/53						HT2C002	11,3 mm	4-14 mm	0,7 mm	20	40
-----------	--	--	--	--	--	---------	---------	---------	--------	----	----

DE Klammern J EN Staples, type J FR Pack de agrafes Type J ES Paquete de grapas tipo J HR Sprajalice J HU J tűzőgép karcsok RO Capse J BG Скоби тип J

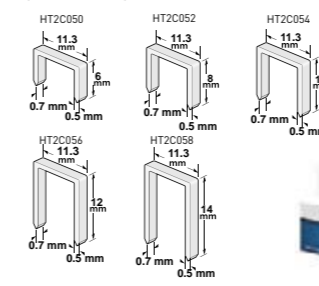

HT2C050	11,3 mm	6 mm	0,7 mm	20	200						
HT2C052	11,3 mm	8 mm	0,7 mm	20	200						
HT2C054	11,3 mm	10 mm	0,7 mm	20	200						
HT2C056	11,3 mm	12 mm	0,7 mm	20	200						
HT2C058	11,3 mm	14 mm	0,7 mm	20	150						

STEEL	x1000	TYPE J/53									
-------	-------	-----------	--	--	--	--	--	--	--	--	--

DE Handtacker EN Staple gun FR Agrafeuse-cloueuse ES Grapadora, clavadora HR Ručna klamera HU Tűzőgép RO Capsator BG Ръчен телбод/такер



AI	TYPE J/53					HT2C004	10,6 mm	6-16 mm	0,7 mm	12	24
15 mm	16 mm						11,3 mm	4-14 mm	0,7 mm		

DE Nägel EN Nails FR Nails ES Clavos HR Čelični čavli HU Acél szegek RO Cuie de oțel BG Пирони, тип J

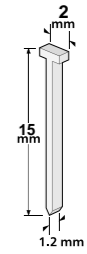

STEEL	x500	TYPE J	T HEAD			HT2C059	15 x 1 mm	20	200		
-------	------	--------	--------	--	--	---------	-----------	----	-----	--	--

DE Blindnietzange EN Hand riveter FR Riveteuse réglable ES Remachadora con regulación HR Ručna zakovica, bočna HU Forgatható fejú kézi szegecselő RO Nitura de mana cu cap rotativ BG Ръчна нитачка странична



STEEL STAINLESS STEEL	ALUMINIUM	x3 CrMo	215mm								
∅	2,4 mm	3,2 mm	4,0 mm	4,8 mm							
STEEL	✓	✓	✓	✓							
STAINLESS STEEL	✓	✓	✓	✓							
ALUMINIUM	✓	✓	✓	-							

AI	ERGO GRIP	x4				HT2C152	2,4 / 3,2 / 4,0 / 4,8 mm	5	20		
----	-----------	----	--	--	--	---------	--------------------------	---	----	--	--

DE 2-Hand Blindnietzange EN Two-hand riveter FR Pince à riveter à deux mains ES Remachador a dos manos HR Ručna zakovica, s polugom HU Kézi szegecselő RO Nitura de mana cu parghie BG Ръчна нитачка лост



AI	x3 CrMo	x5									
∅	2,4 mm	3,2 mm	4,0 mm	4,8 mm							
STEEL	✓	✓	✓	✓							
STAINLESS STEEL	✓	✓	✓	✓							
ALUMINIUM	✓	✓	✓	✓							

AI	ERGO GRIP	280mm				HT2C154	2,4 / 3,2 / 4,0 / 4,8 mm	5	20		
----	-----------	-------	--	--	--	---------	--------------------------	---	----	--	--

DE 2-Hand Blindnietzange EN Two-hand riveter FR Pince à riveter à deux mains ES Remachador a dos manos HR Ručna zakovica, s polugom HU Kézi szegecselő RO Nitura de mana cu parghie BG Ръчна нитачка лост



AI	x3 CrMo	x5									
∅	3,2 mm	4,0 mm	4,8 mm	6,0 mm	6,4 mm						
ALUMINIUM	✓	✓	✓	✓	✓						
STEEL	✓	✓	✓	✓	✓						
STAINLESS STEEL	✓	✓	✓	✓	✓						

AI	ERGO GRIP	530mm				HT2C156	3,2 / 4,0 / 4,8 / 6,0 / 6,4 mm	5	20		
----	-----------	-------	--	--	--	---------	--------------------------------	---	----	--	--

DE Nietmaschinen für Nietmuttern EN Screw nut gun FR Pince pour rivets filetés ES Remachadora para remaches HR Ručna zakovica, bočna HU Forgatható fejú kézi szegecselő RO Nitura de mana cu cap rotativ BG Нитачка за нит гайки



AI	M3-M6	ERGO HANDLE				HT2C180	M3 / M4 / M5 / M6	5	20		
----	-------	-------------	--	--	--	---------	-------------------	---	----	--	--

DE Nietmaschinen für Nietmuttern EN Screw nut gun FR Pince pour rivets filetés ES Remachadora para remaches HR Ručna zakovica, s polugom HU Kézi szegecseelő RO Nitura de mana cu parghie BG Нитачка за нит гайки



360mm	M3 - M10	ERGO HANDLE					
HT2C181	M3 / M4 / M5 / M6 / M8 / M10			1	10		

DE Nietpresse für Spreizdübel EN Riveter for pins FR Riveteuse pour épingles ES Remachadora de tacho HR Ručna zakovica HU Kézi szegecseelő RO Nitura de mana BG Нитачка за разширителни болтове



180mm	MOLLY	ERGO HANDLE					
HT2C191	4 / 5 / 6 mm			5	20		

DE LötKolben EN Soldering iron FR Fer à souder ES Soldador lápiz HR Štapne lemilica HU Forrasztópáka RO Fier de lipit BG Поялник



230V ~50Hz							
HT2C301	30 W	380	4 mm	1	50		
HT2C303	80 W	530	7 mm	1	50		

DE LötKolben EN Soldering iron FR Fer à souder ES Soldador lápiz HR Štapne lemilica HU Forrasztópáka RO Fier de lipit BG Поялник



230V ~50Hz							
HT2C306	60 W	480	6 mm	1	50		
HT2C308	100 W	550	8 mm	1	50		

DE Lötpistole EN Transformer soldering iron FR Fer à souder transformateur ES Soldador con transformador HR Pištolj lemelica HU Transzformátoros forrasztópáka RO Fier de lipit cu transformator BG Поялник индукционен



100 W	230V ~50Hz	500°C	12/48S	LED			
HT2C310	100 W	500			1	6	

DE Lötpistole EN Transformer soldering iron FR Fer à souder transformateur ES Soldador con transformador HR Pištolj lemelica HU Transzformátoros forrasztópáka RO Fier de lipit cu transformator BG Поялник индукционен



200 W	230V ~50Hz	70-200°C	1 2 3	1 2 3			
HT2C311	200 W	500			1	10	



**HÖGERT**  
technik



DE Elektrowerkzeuge

EN Power Tools

FR Outils Électroportatifs

ES Herramientas Eléctricas

HR Električni Alati

HU Szerszámgépek

RO Scule Electrice

BG Электрически Инструменти

DE Akku-Schlagschrauber EN Cordless impact wrench FR Boulonneuse à chocs sans fil ES Llave de impacto sin cable HR Baterija za HT2E200 HU Akkumulátor HT2E200-hoz RO Baterie pentru HT2E200 BG Ударен ключ акумулаторов



20 V	400 Nm	BRUSHLESS	2.0 Ah	Speed control	HT2E200	1	4
------	--------	-----------	--------	---------------	---------	---	---

DE Akku für Schlagschrauber EN Battery for HT2E200 FR Batterie pour boulonneuse à chocs ES Bateria para llave de impacto HR Baterija za HT2E200 HU Akkumulátor HT2E200-hoz RO Baterie pentru HT2E200 BG Акумулатор за HT2E200



20 V	2.0 Ah	fits to HT2E200	HT2E210	1	20
------	--------	-----------------	---------	---	----

DE Akku für Schlagschrauber EN Battery for HT2E200 FR Batterie pour boulonneuse à chocs ES Bateria para llave de impacto HR Baterija za HT2E200 HU Akkumulátor HT2E200-hoz RO Baterie pentru HT2E200 BG Акумулатор за HT2E200



20 V	4.0 Ah	fits to HT2E200	HT2E211	1	20
------	--------	-----------------	---------	---	----

DE Heissluftpistole EN Hot air gun FR Décapeur thermique ES Pistola de aire caliente HR Toplozračni pištolj HU Hőlégfúvó RO Suflanta de caldura BG Истолет за горещ въздух



2000 W	MAX 600°C	x4	HT2C551	2000 W	600°C	1	10
0 1 2 300 l/min 60-350°C	0 1 2 500 l/min 60-600°C	230V ~50Hz					

DE Heissluftpistole EN Hot air gun FR Décapeur thermique ES Pistola de aire caliente HR Toplozračni pištolj HU Hőlégfúvó RO Suflanta de caldura BG Истолет за горещ въздух



2000 W	MAX 600°C	x4	HT2C550	2000 W	600°C	1	10
0 1 2 300 l/min -350°C	0 1 2 500 l/min -600°C	230V ~50Hz					

DE Heissluftpistole EN Hot air gun FR Décapeur thermique ES Pistola de aire caliente HR Toplozračni pištolj HU Hőlégfúvó RO Suflanta de caldura BG Истолет за горещ въздух



2000 W	MAX 600°C	x4	HT2C552	2000 W	600°C	1	5
0 1 2 300 l/min 250 l/min	0 1 2 450°C 100°C 600°C 350 l/min	280 l/min 50°C					



DE Mini-Schleifer mit Stromanschluss EN Mini Grinder FR Outil multifonction à alimentation sur secteur ES Mini lijadora con cable HR Mini brusilica HU Mini köszörű RO Mini polizor cu fir BG Мини шлайф



170 W	8000-35000/min	3,2 mm		
x5	ERGO GRIP	230V ~50Hz		
HT2E100	RPM <sup>-1</sup> 8000-35000 rpm <sup>-1</sup>	1	8	

DE Mini-Akkuschleifer EN Cordless mini Grinder FR Mini ponceuse sans fil ES Mini lijadora sin cable HR Aku mini brusilica HU Mini vezeték nélküli köszörű RO Mini polizor fara fir BG Акумулаторен мини шлайф



7,2 V	Li-Ion 900mA	5000-25000/min		
3,2 mm	x24	LED LIGHT		
HT2E105	RPM <sup>-1</sup> 5000-25000 rpm <sup>-1</sup>	1	10	

DE Ersatzzubehör-Set für Mini-Schleifer EN Mini Grinder Accessory Set FR Jeu d'accessoires de rechange pour outil multifonction ES Conjunto de accesorios de repuesto para mini lijadora HR Set rezervnog pribora za mini brusilice HU Mini köszörű tartozékkészlet RO Set de accesorii cu 145 buc BG Комплект аксесоари за мини шлайф



- Mandrels [2 x 3,2 mm, 1 x 2,3 mm] – 3 pcs
- Abrasive rolls [12,7 x 12,7 mm] – 8 pcs
- Abrasive rolls [6,3 x 12,7 mm] – 8 pcs
- Pointed abrasive discs [9,5 x 19 mm] – 1 pc
- Abrasive disc [25,4 x 6,3 mm] – 1 pc
- Abrasive disc [12,7 x 6,3 mm] – 4 pc
- Spanner – 1 pc
- Abrasive discs – 40 pcs
- Rubber disc [22 x 2,5 mm] – 1 pc
- Fabric disc [25 x 4,5 mm] – 1 pc
- Fibreglass cutting discs [32 x 1,2 mm] – 5 pcs
- Abrasive discs [20 x 3,2 mm] – 12 pcs
- Sanding stone – 1 pc
- Cutting wheels [24 x 0,4 mm] – 36 pcs
- Brushes [ø 3,2 mm] – 2 pcs
- Abrasive discs and mandrels [ø 3,2 mm] – 6 pcs
- Mandrels for abrasive discs [6,3 x 12,7 mm, 12,7 x 12,7 mm] – 2 pcs
- Mandrels for cutting discs [ø 3,2 mm] – 2 pcs
- Mandrels for polishing wheels [ø 3,2 mm] – 1 pc
- HSS cutter [ø 3,2 mm] – 1 pc
- Diamond drills [ø 3,2 mm] – 5 pcs
- HSS drills [2 x 2,3 mm, 2 x 3,2 mm] – 4 pcs

x145

HT2E115	1	20
---------	---	----

DE Mini-Schleifer mit Stromanschluss EN Mini Grinder FR Outil multifonction à alimentation sur secteur ES Mini lijadora con cable HR Mini brusilica HU Mini szlifierka RO Mini polizor cu fir BG Мини шлайф



130 W	10000-32000/min	3,2 mm	x170	
FLEXIBLE SHAFT	ERGO GRIP	230V ~50Hz		
HT2E101	RPM <sup>-1</sup> 10000-32000 rpm <sup>-1</sup>	1	8	

DE Mini-Akkuschleifer EN Cordless mini Grinder FR Mini ponceuse sans fil ES Mini lijadora sin cable HR Aku mini brusilica HU Mini vezeték nélküli köszörű RO Mini polizor fara fir BG Акумулаторен мини шлайф



3,6 V	Li-Ion 600mA	5000-10000/min		
3,2 mm	x10	Mabuchi motor		
HT2E106	RPM <sup>-1</sup> 5000/10000/15000 rpm <sup>-1</sup>	1	20	

DE Ersatzzubehör-Set für Mini-Schleifer EN Mini Grinder Accessory Set FR Jeu d'accessoires de rechange pour outil multifonction ES Conjunto de accesorios de repuesto para mini lijadora HR Set rezervnog pribora za mini brusilice HU Mini köszörű tartozékkészlet RO Set de accesorii cu 72 buc BG Комплект аксесоари за мини шлайф



x72

- Abrasive rollers mandrel - 2 pcs
- Cutting wheel mandrel - 1 pc
- Polishing pad mandrel - 1 pc
- HSS cutter - 1 pc
- Diamond drills - 5 pcs
- Steel brushes - 2 pcs
- Grinding stones - 4 pcs
- Abrasive rollers - 4 pcs
- Handles - 2 pcs
- Pointed polishing disc - 1 pc
- Polishing disc - 10 pcs
- Polishing paste - 1 pc
- Abrasive discs - 38 pcs

HT2E116	1	20
---------	---	----

DE Graviergerät EN Engraving Tool FR Graveur ES Grabador eléctrico HR Brusilica za graviranje HU Gravírozó berendezés RO Instrument de gravat BG Устройство за гравирание



13 W	7200/min	FORCE x5	tungsten carbide tip x2	230V ~50Hz		
HT2E130	RPM <sup>-1</sup> 7200 rpm <sup>-1</sup>	1	20			



**HÖGERT**  
technik

DE Zubehör Für Werkzeugkasten

EN Tool Storage

FR Stockage Des Outils

ES Almacenamiento De Herramientas

HR Pohrana Alata

HU Szerszámtárolók

RO Depozitarea Uneltelor

BG Съхраняване На Инструменти



DE Werkstattwagen EN Tool cabinet with opening protection FR Armoire d'atelier à tiroirs ES Armario de herramientas HR Ormar za radionice HU Műhelyszekrény, 6 fiókkal RO Dulap pentru atelier BG Шкаф за инструменти със защита за отваряне



4x75 mm  
 1x154 mm  
 1x233 mm  
 low drawers MAX 15 kg  
 high drawers MAX 25 kg  
 STEEL  
 ABS  
 EVA INSERTS  
 DRAWER SELF-OPENING PROTECTION  
 LOCK with 2 KEYS  
 x4 5x1,25"  
 x2 WITH BRAKES  
 SELF CLOSING

HT7G045	708 x 459 x 977 mm	6	1	1
---------	--------------------	---	---	---

DE Werkzeugwagen EN Tool cabinet FR Servante d'atelier ES Carro portaherramienta HR Ormarčić za alat HU Szerszámszekrény RO Cabinet de scule BG Шкаф за инструменти



PL  
 EN  
 4x75 mm  
 2x154 mm  
 low drawers MAX 15 kg  
 high drawers MAX 25 kg  
 DRAWER LOCK  
 STEEL  
 ABS  
 x4 5x1,25"  
 LOCK with 2 KEYS  
 x2 WITH BRAKES  
 SELF CLOSING

HT7G046	760 x 460 x 910 mm	6	1	1
---------	--------------------	---	---	---

DE Werkzeugwagen EN Tool cabinet FR Servante d'atelier ES Armario para herramientas HR Dulap pentru atelier HU Szerszámszekrény RO Cabinet de scule BG Шкаф за инструменти



6x75 mm  
 1x154 mm  
 low drawers MAX 15 kg  
 high drawers MAX 25 kg  
 DRAWER LOCK  
 STEEL  
 ABS  
 x4 5x1,25"  
 LOCK with 2 KEYS  
 x2 WITH BRAKES  
 SELF CLOSING

HT7G047	760 x 460 x 910 mm	7	1	1
---------	--------------------	---	---	---

DE Werkstattwagen EN Tool cabinet with opening protection FR Armoire d'atelier à tiroirs ES Armario de herramientas HR Ormar za radionice HU Műhelyszekrény, 6 fiókkal RO Dulap pentru atelier BG Шкаф за инструменти със защита за отваряне



DRAWER SELF-OPENING PROTECTION  
 5x75 mm  
 2x154 mm  
 low drawers MAX 15 kg  
 high drawers MAX 25 kg  
 STEEL  
 ABS  
 EVA INSERTS  
 LOCK with 2 KEYS  
 x4 5x1,25"  
 x2 WITH BRAKES  
 SELF CLOSING

HT7G048	708 x 459 x 977 mm	7	1	1
---------	--------------------	---	---	---

DE Werkzeugschrank EN Tool cabinet with side door FR Armoire d'atelier à tiroirs avec porte latérale ES Carro de herramientas con cajones y puerta lateral HR Ormarčić za alat HU Szerszámszekrény RO Cabinet de scule BG Шкаф за инструменти със странична вратичка



SIDE DOOR  
 6x50 mm  
 1x130 mm  
 low drawers MAX 15 kg  
 high drawers MAX 25 kg  
 DRAWER LOCK  
 STEEL  
 ABS  
 EVA INSERTS  
 LOCK with 2 KEYS  
 x4 5x1,25"  
 x2 WITH BRAKES  
 SELF CLOSING

HT7G049	700 x 455 x 900 mm	7	1	5
---------	--------------------	---	---	---

DE Werkzeugschrank, 544 Artikel EN Tool cabinet with side door and accessories, 544 pcs FR Armoire d'atelier à tiroirs avec porte latérale, 544 éléments ES Carro de herramientas con cajones y puerta lateral, 544 elementos HR Ormarčić za alat, 544 kom. HU Szerszámszekrény, 544 db RO Cabinet de scule, 544 buc BG Шкаф за инструменти със странична вратичка, 544 бр.



NEW  
 x544  
 SIDE DOOR  
 6x50 mm  
 1x130 mm  
 low drawers MAX 15 kg  
 high drawers MAX 25 kg  
 DRAWER LOCK  
 STEEL  
 ABS  
 EVA INSERTS  
 LOCK with 2 KEYS  
 x4 5x1,25"  
 x2 WITH BRAKES  
 SELF CLOSING

HT7G148, HT7G149, HT7G153, HT7G120, HT7G122, HT7G152, HT7G150, HT7G154, HT7G155, HT7G159, HT7G157, HT7G161

HT7G050	700 x 455 x 900 mm	7	1	5
---------	--------------------	---	---	---



DE Werkzeugschrank, 171 Artikel EN Tool cabinet with accessories, 171 pcs FR Servante d'atelier, 171 elements ES Armario para herramientas, 171 elementos HR Ormarić za alat, 171 kom. HU Szerszámszekrény, 171 db RO Cabinet de scule, 171 buc BG Шкаф за инструменти с аксесоари, 171 бр.



HT7G120, HT7G121, HT7G122, HT7G124, HT7G125, HT7G127, HT7G128, HT7G130, HT7G132, HT7G133, HT7G134, HT7G137

x171	4x75 mm	2x154 mm	low drawers MAX 15 kg
high drawers MAX 25 kg	DRAWER LOCK	STEEL	ABS
x4 5x1,25"	x2 WITH BRAKES	LOCK with 2 KEYS	

HT7G052	760 x 460 x 910 mm	6	1	1
---------	--------------------	---	---	---

DE Werkzeugwagen, 238 Artikel EN Tool cabinet, 238 pcs FR Servante d'atelier, 238 elements ES Armario para herramientas, 238 elementos HR Ormarić za alat, 238 kom. HU Szerszámszekrény, 238 db RO Cabinet de scule, 238 buc BG Шкаф за инструменти с аксесоари, 238 бр.



HT7G120, HT7G121, HT7G122, HT7G123, HT7G124, HT7G125, HT7G130, HT7G132, HT7G133, HT7G135, HT7G137, HT7G145, HT7G146, HT7G148, HT7G149

x238	6x75 mm	1x154 mm	low drawers MAX 15 kg	high drawers MAX 25 kg	DRAWER LOCK
STEEL	ABS	x4 5x1,25"	LOCK with 2 KEYS		

HT7G055	760 x 460 x 910 mm	7	1	1
---------	--------------------	---	---	---

DE Werkzeugschrank, 214 Artikel EN Tool cabinet, 214 pcs FR Servante d'atelier, 214 elements ES Armario para herramientas, 214 elementos HR Ormarić za alat, 214 kom. HU Szerszámszekrény, 214 db RO Cabinet de scule, 214 buc BG Шкаф за инструменти с аксесоари, 214 бр.



HT7G120, HT7G121, HT7G122, HT7G124, HT7G125, HT7G126, HT7G127, HT7G128, HT7G130, HT7G131, HT7G132, HT7G133, HT7G134, HT7G135, HT7G137

x214	4x75 mm	2x154 mm	low drawers MAX 15 kg	high drawers MAX 25 kg	DRAWER LOCK
STEEL	ABS	x4 5x1,25"	LOCK with 2 KEYS		

HT7G056	760 x 460 x 910 mm	6	1	1
---------	--------------------	---	---	---

DE Werkzeugschrank, 258 Artikel EN Tool cabinet, 258 pcs FR Servante d'atelier, 258 elements ES Armario para herramientas, 258 elementos HR Ormarić za alat, 258 kom. HU Szerszámszekrény, 258 db RO Cabinet de scule, 258 buc BG Шкаф за инструменти с аксесоари, 258 бр.



HT7G120, HT7G121, HT7G122, HT7G124, HT7G125, HT7G127, HT7G128, HT7G130, HT7G131, HT7G132, HT7G133, HT7G134, HT7G135, HT7G145, HT7G148

x252	6x75 mm	1x154 mm	low drawers MAX 15 kg	high drawers MAX 25 kg	DRAWER LOCK
STEEL	ABS	x4 5x1,25"	LOCK with 2 KEYS		

HT7G058	760 x 460 x 910 mm	7	1	1
---------	--------------------	---	---	---

DE Werkzeugschrank, 304 Artikel EN Tool cabinet, 304 pcs FR Servante d'atelier, 304 elements ES Armario para herramientas, 304 elementos HR Ormarić za alat, 304 kom. HU Szerszámszekrény, 304 db RO Cabinet de scule, 304 buc BG Шкаф за инструменти с аксесоари, 304 бр.



HT7G120, HT7G124, HT7G132, HT7G133, HT7G134, HT7G148, HT7G149, HT7G150, HT7G151

x304	6x60 mm	1x140 mm	THICKNESS 1,0 mm	65kg	MAX 25 kg
SOFT CLOSE	LOCK with 2 KEYS	STEEL	WOODEN WORKTOP 10 mm		

HT7G059	96,8 x 72 x 46 cm	7	1	1
---------	-------------------	---	---	---

DE Maul-Ring-Schlüsselsatz EN Combination spanner set FR Jeu de clés mixtes ES Juego de llaves planas y de estrella HR Set viljuškasto-okastih ključeva HU Kombinált villáskulcs készlet RO Set de chei combinate BG Комплект комбиниран-гаечен ключ



HT1W406 (6 mm), HT1W407 (7 mm), HT1W408 (8 mm), HT1W409 (9 mm), HT1W410 (10 mm), HT1W411 (11 mm), HT1W412 (12 mm), HT1W413 (13 mm), HT1W414 (14 mm), HT1W415 (15 mm), HT1W416 (16 mm), HT1W417 (17 mm), HT1W418 (18 mm), HT1W419 (19 mm), HT1W420 (20 mm), HT1W421 (21 mm)

x16	6-21 mm	CrV	EVA
-----	---------	-----	-----

HT7G120	39,5 x 18 cm	1	5
---------	--------------	---	---

DE Maul-Ring-Schlüsselsatz EN Combination spanner set FR Jeu de clés mixtes ES Juego de llaves planas y de estrella HR Set viljuškasto-okastih ključeva HU Kombinált villáskulcs készlet RO Set de chei combinate BG Комплект комбиниран-гаечен ключ



HT1W422 (22 mm), HT1W424 (24 mm), HT1W427 (27 mm), HT1W428 (28 mm), HT1W430 (30 mm), HT1W432 (32 mm)

HT7G121	39,5 x 18 cm	1	5
---------	--------------	---	---

DE Doppelschraubenschlüsselsatz EN Double open-end spanner set FR Jeu de clés polygonales ES Juego de llaves planas y de estrella HR Set ukošenih okastih ključeva HU Hajlított gyűrűs villáskulcsok RO Set de chei cu inel îndoiti BG Комплект гаечни ключове



HT1W541 (6 x 7 mm), HT1W542 (8 x 9 mm), HT1W544 (10 x 11 mm), HT1W546 (12 x 13 mm), HT1W548 (14 x 15 mm), HT1W549 (16 x 17 mm), HT1W551 (18 x 19 mm)

HT7G122	39,5 x 18 cm	1	5
---------	--------------	---	---

DE Doppelschraubenschlüsselsatz EN Double open-end spanner set FR Jeu de clés polygonales ES Juego de llaves planas y de estrella HR Set ukošenih okastih ključeva HU Hajlított gyűrűs villáskulcsok RO Set de chei cu inel îndoiti BG Комплект гаечни ключове



HT1W553 (20 x 22 mm), HT1W554 (21 x 23 mm), HT1W555 (24 x 27 mm), HT1W551 (30 x 32 mm)

HT7G123	39,5 x 18 cm	1	5
---------	--------------	---	---

DE Bitsatz EN Bit set FR Jeu d'embouts de vissage ES Juego de puntas de destornillador HR Set bitova odvijača HU Csavarhúzó készlet RO Set de șurubelniță BG Комплект сменяеми накрайници за отвертки



HT1S404  
 ● 30 mm: T20, T25, T30, T40, T45, T50, T55  
 ● 75 mm: T20, T25, T30, T40, T45, T50, T55  
 ● 30 mm: M5, M6, M8, M10, M12  
 ● 75 mm: M5, M6, M8, M10, M12  
 ● 30 mm: H4, H5, H6, H7, H8, H10, H12  
 ● 75 mm: H4, H5, H6, H7, H8, H10, H12  
 Bit holders for screwdriver bits: 10 mm 3/8", 10 mm 1/2"

HT7G124	39,5 x 18 cm	1	10
---------	--------------	---	----

DE Steckschlüsselsatz mit Ratche EN Sockets set with ratchet FR Jeu de clés à cliquet, d'outils et de douilles ES Juego de herramientas con carraca HR Set alata s račnom HU Racsnis szerszámkészlet RO Set de instrumente cu clichet BG Комплект инструменти с тресчотка



HT1A002 (4 mm), HT1A003 (4,5 mm), HT1A004 (5 mm), HT1A005 (5,5 mm), HT1A006 (6 mm), HT1A007 (7 mm), HT1A008 (8 mm), HT1A009 (9 mm), HT1A010 (10 mm), HT1A011 (11 mm), HT1A012 (12 mm), HT1A013 (13 mm), HT1A014 (14 mm), HT1A771 (F3/8" x M1/4"), HT1A772 (F3/8" x M1/2"), HT1A752 (1/4"), HT1A701 (50 mm), HT1A703 (100 mm), HT1A740 (150 mm), HT1A755 (1/4"), HT1A744, HT1S203 (150 mm), HT1R324, HT1S301 (PH1 - 25 mm), HT1S302 (PH2 - 25 mm), HT1S303 (PH3 - 25 mm), HT1S361 (T10 - 25 mm), HT1S362 (T15 - 25 mm), HT1S363 (T20 - 25 mm), HT1S364 (T25 - 25 mm), HT1S366 (T30 - 25 mm), HT1S367 (T40 - 25 mm), HT1S359 (H3, H4 - 25 mm)

HT7G126	39,5 x 18 cm	1	5
---------	--------------	---	---

DE Steckschlüsselsatz mit Ratche EN Sockets set with ratchet FR Jeu de clés à cliquet, d'outils et de douilles ES Juego de herramientas con carraca HR Set alata s račnom HU Racsnis szerszámkészlet RO Set de instrumente cu clichet BG Комплект инструменти с тресчотка



1/4": E5, E6, E7, E8  
 3/8": E10, E12, E14, E16  
 1/2": E10, E11, E12, E14, E16, E18, E20, E22, E24  
 HT1A771 (F3/8" x M1/4"), HT1A772 (F3/8" x M1/2"), HT1A714 (3/8"), HT1R328 (3/8")

HT7G127	39,5 x 18 cm	1	5
---------	--------------	---	---

x21	1/4"	E-type
CrV	EVA	



DE Steckschlüsselsatz mit Ratche EN Sockets set with ratchet FR Jeu de clés à cliquet, d'outils et de douilles ES Juego de herramientas con carraca HR Set alata s račnom HU Racsnis szerszámkészlet RO Set de instrumente cu clichet BG Комплект инструменти с тресчотка



HT1A210 (10 mm), HT1A211 (11 mm), HT1A212 (12 mm), HT1A213 (13 mm), HT1A214 (14 mm), HT1A215 (15 mm), HT1A216 (16 mm), HT1A217 (17 mm), HT1A218 (18 mm), HT1A219 (19 mm), HT1A220 (20 mm), HT1A221 (21 mm), HT1A222 (22 mm), HT1A223 (23 mm), HT1A224 (24 mm), HT1A227 (27 mm), HT1A230 (30 mm), HT1A232 (32 mm), HT1A236 (36 mm), HT1R322 (1/2"), HT1A724 (1/2" 127 mm), HT1A727 (1/2", 254 mm), HT1A757 (1/2")

HT7G128	39,5 x 18 cm	1	5

x23 1/2" CrV EVA

DE Schlag Steckschlüsselsatz EN Impact sockets set FR Jeu de douilles à percussion ES Juego de llaves de impacto HR Set udarnih nasadnih ključeva HU Hosszú dugókulcs készlet RO Set de prize lungi de impact BG Комплект ударни вложки



1/2": 10, 12, 13, 14, 15, 16, 17, 18, 19, 21, 22, 24, 27, 30, 32 mm

HT7G129	39,5 x 18 cm	1	5

x15 1/2" DEEP CrMo EVA

DE Schraubendreher- und Inbusschlüssel-Satz EN Set of screwdrivers, HEX and TORX keys FR Jeu de tournevis et de clés Allen ES Juego de destornilladores, llaves hexagonales y TORX HR Set odvijáča i Allen ključeva HU Csavarhűzők és hatlapú kulcsok RO Set de șurubelnițe și chei hexagonale BG Отвертка, комплект HEX и TORX ключове



HT1S066 (6 x 125 mm), HT1S072 (PH2 125 mm), HT1W804 (1,5 - 10 mm), HT1W814 (T10 - T50)

HT7G134	39,5 x 18 cm	1	10

x20 SL PH CrV EVA HEX TORX

DE Werkzeugsatz EN Tool set FR Jeu de marteaux et de burins ES Juego de herramientas HR Set alata HU Szerszámkészlet RO Set de scule BG Комплект инструменти



HT3B005 (500 g), HT3B721 (10 x 8 x 142 mm), HT3B722 (13 x 10 x 150 mm), HT3B728 (6 x 10 x 102 mm), HT3B729 (8 x 11 x 115 mm)

HT7G135	39,5 x 18 cm	1	1

x5 500g CrV EVA

DE Zangesatz EN Pliers set FR Jeu de pinces ES Juego de alicates HR Set kliješta HU Fogó készlet RO Set de clești BG Комплект клещи



HT1P008 (180 mm), HT1P010 (160 mm), HT1P016 (160 mm), HT1P022 (160 mm)

HT7G130	39,5 x 18 cm	1	10

x4 CrV EVA

DE Zangesatz EN Retaining ring pliers set FR Jeu de pinces pour bague de retenue ES Juego de alicates circlip HR Set kliješta za pričvrnsne prstenove HU Gyűrűs kapcsoló fogó RO Cleste pentru inel BG Комплект клещи за зережки



HT1P141 (180 mm), HT1P142 (180 mm), HT1P143 (180 mm), HT1P144 (180 mm)

HT7G131	39,5 x 18 cm	1	10

x4 CrV EVA

DE Werkzeugsatz EN Wrenches set FR Jeu de pinces et clé ES Juego de llaves HR Set ključeva HU Kulcs készlet RO Set de chei BG Комплект ключове



HT1P560 (250 mm), HT1P562 (140 mm), HT1P372 (250 mm)

HT7G136	39,5 x 18 cm	1	1

x3 EVA CrV

DE Schraubenziehersatz EN 1000 V slotted screwdrivers set FR Jeu de tournevis 1000 V ES Juego de destornilladores 1000 V HR Set odvijáča 1000 V HU Szigetelt hornyos csavarhűzők RO Set de șurubelnițe cu fante izolate BG Комплект изолирани отвертки 1000 V и тестер за напрежение



HT1S960 (3 x 100 mm), HT1S961 (4 x 100 mm), HT1S962 (5,5 x 125 mm), HT1S968 (PZ1 100 mm), HT1S969 (PZ2 100 mm), HT1S981

HT7G137	39,5 x 18 cm	1	1

x6 EVA CrMo 1000V SL PH

DE Schraubenziehersatz EN Screwdrivers set FR Jeu de tournevis plats ES Juego de destornilladores planos HR Set ravnih odvijáča HU Lapos csavarhűző készlet RO Set de șurubelnițe cu fante BG Комплект отвертки



HT1S001 (3 x 75 mm), HT1S004 (4 x 100 mm), HT1S008 (5 x 100 mm), HT1S010 (6,5 x 38 mm), HT1S012 (6 x 100 mm), HT1S014 (6 x 150 mm), HT1S016 (8 x 150 mm)

HT7G132	39,5 x 18 cm	1	5

x7 SL S2 EVA

DE Schraubenziehersatz EN PH 'Screwdrivers set FR Jeu de tournevis ES Juego de destornilladores HR Set odvijáča HU PH Phillips csavarhűző készlet RO Set de șurubelnițe PH Phillips BG Комплект отвертки



HT1S020 (PH1 75 mm), HT1S023 (PH1 75 mm), HT1S024 (PH1 100 mm), HT1S028 (PH2 38 mm), HT1S029 (PH2 100 mm), HT1S032 (PH2 200 mm)

HT7G133	39,5 x 18 cm	1	5

x6 PH/PZ S2 EVA

DE Werkzeugsatz EN 1000 V tool set FR Jeu de pinces et tournevis 1000 V ES Juego de alicantes y destornilladores 1000 V HR Set alata 1000 V HU Szigetelt szerszámkészlet RO Set de unelte izolate BG Изолирани отвертки 1000 V комплект



HT1P903 (160 mm), HT1P909 (160 mm), HT1S968 (PZ1 100 mm), HT1S969 (PZ2 100 mm), HT1S981

HT7G139	39,5 x 18 cm	1	1

x5 CrV 1000V PZ EVA CrMo

DE Werkzeugsatz EN Tool set FR Jeu d'outils ES Juego de herramientas HR Set alata HU Szerszámkészlet RO Set de scule BG Изолирани отвертки



HT1P903 (160 mm), HT1S960 (3 x 100 mm), HT1S968 (PZ1 100 mm), HT1S969 (PZ2 100 mm), HT1P182, HT1S981

HT7G141	39,5 x 18 cm	1	1

x6 CrV 1000V VDE SL PZ EVA CrMo

DE Blindnietzange EN Riveter set with room for rivets FR Riveteuse ES Juego de remachadora y cajas para remaches HR Pištolj za slijepe zakovice HU Szegecselő RO Nituitor BG Ръчна нитачка за нит гайки - комплект с нит гайки



HT2C152 + 4 blanks for rivets

HT7G142	39,5 x 18 cm	1	1

x1 EVA

DE Werkzeugsatz EN Tool set FR Jeu d'outils ES Juego de herramientas HR Set alata HU Szerszámkészlet RO Set de scule BG Изолирани отвертки



HT1P612 (6-35 mm),  
HT1P554 (250 mm),  
HT1P520 (1")

HT7G144	39,5 x 18 cm	1	1

x3 EVA

DE Werkzeugsatz EN Tool set with ratchet FR Jeu de clés mixtes avec un joint ES Juego de llaves combinadas HR Set alata s čegrtaljkom HU Racsnis szerszámkészlet RO Set de scule cu clichet BG Комплект инструменти с тресчотка



HT7G148	39,5 x 18 cm	1	5

- HT1A002 (4 mm),  
HT1A003 (4,5 mm),  
HT1A004 (5 mm),  
HT1A005 (5,5 mm),  
HT1A006 (6 mm),  
HT1A007 (7 mm),  
HT1A008 (8 mm),  
HT1A009 (9 mm),  
HT1A010 (10 mm),  
HT1A011 (11 mm),  
HT1A012 (12 mm),  
HT1A013 (13 mm),  
HT1A014 (14 mm),  
HT1A752 (1/4"),  
HT1A604 (E4),  
HT1A605 (E5),  
HT1A606 (E6),  
HT1A607 (E7),  
HT1A608 (E8),  
HT1A609 (E10),  
HT1A705 (1/4", 152,4 mm),  
HT1A740 (18/4", 150 mm),
- HT1R324 (1/4"),  
HT1S203 (1/4"),  
1/4" bit sockets  
PZ3 (HT1S608),  
PZ2 (HT1S607),  
PZ1 (HT1S606),  
PH3 (HT1S603),  
PH2 (HT1S602),  
PH1 (HT1S601),  
T40 (HT1S648),  
T30 (HT1S647),  
T25 (HT1S645),  
T20 (HT1S644),  
T15 (HT1S643),  
T10 (HT1S642),  
T8 (HT1S640),  
SL4, SL5, SL7,  
H8 (HT1S628),  
H7 (HT1S627),  
H6 (HT1S626),  
H5 (HT1S625),  
H4 (HT1S624),
- H3 (HT1S623),  
HT1A744, deep sockets (1/4")  
HT1A052 (4 mm),  
HT1A053 (4,5 mm),  
HT1A054 (5 mm),  
HT1A055 (5,5 mm),  
HT1A056 (6 mm),  
HT1A057 (7 mm),  
HT1A058 (8 mm),  
HT1A059 (9 mm),  
HT1A060 (10 mm),  
HT1A061 (11 mm),  
HT1A062 (12 mm),  
HT1A063 (13 mm),  
HT1A064 (14 mm),  
HT1A755 (1/4", 35 mm),  
HT1A701 (1/4", 50,8 mm),  
HT1A703 (1/4", 101 mm)

x63 1/4" 72T CrV EVA

DE Werkzeugsatz EN Open-ended spanner set FR Jeu de clés plates ES Juego de llaves planas HR Set viljuškastih dvostranih ključeva HU Nyitott kulcskészlet RO Set de chei deschise BG Гаечен комплект



HT1W501 (6 x 7 mm),  
HT1W502 (8 x 9 mm),  
HT1W504 (10 x 11 mm),  
HT1W506 (12 x 13 mm),  
HT1W507 (13 x 17 mm),  
HT1W508 (14 x 15 mm),  
HT1W509 (16 x 17 mm),  
HT1W510 (17 x 19 mm),  
HT1W511 (18 x 19 mm),  
HT1W512 (19 x 22 mm),  
HT1W513 (20 x 22 mm),  
HT1W514 (21 x 23 mm),  
HT1W515 (24 x 27 mm),  
HT1W516 (25 x 28 mm),  
HT1W517 (30 x 32 mm)

HT7G145	39,5 x 18 cm	1	5

x15 15° DIN 3110 CrV EVA

DE Werkzeugsatz EN Combination spanner set with ratchet FR Jeu de clés mixtes à cliquet ES Juego de llaves combinadas HR Set viljuškasto-okastih ključeva s čegrtaljkom HU Lapos gyűrűs racsnis villáskulcs készlet RO Set de chei inel plat de cu clichet BG Комплект комбинирани-гаечен ключ с рачет

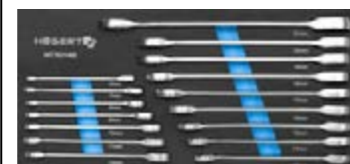

HT1R006 (6 mm),  
HT1R007 (7 mm),  
HT1R008 (8 mm),  
HT1R009 (9 mm),  
HT1R010 (10 mm),  
HT1R011 (11 mm),  
HT1R012 (12 mm),  
HT1R013 (13 mm),  
HT1R014 (14 mm),  
HT1R015 (15 mm),  
HT1R016 (16 mm),  
HT1R017 (17 mm),  
HT1R018 (18 mm),  
HT1R019 (19 mm),  
HT1R020 (20 mm),  
HT1R021 (21 mm)

HT7G146	39,5 x 18 cm	1	5

x16 15° 72T CrV EVA

DE Bitsatz EN Bit set FR Jeu d'embouts de vissage ES Juego de puntas de destornillador HR Set bitova odvijača HU Csavarhúzó készlet RO Set de șurubelniță BG Комплект сменями накрайници за отвертки



- HT1S201 (100 mm),  
HT1S203 (150 mm),  
HT1A752 (1/4"),  
1/4" 65 mm,  
3/8" 65 mm,  
1/2" 75 mm,  
HT1S457 (8 mm),  
HT1S458 (10 mm),  
HT1S459 (12 mm),  
HT1S460 (13 mm),  
magnetic extension bit holder S2,  
HT1S439 (60 mm),  
magnetic bit holder with quick release,  
HT1S300 (PH0 25 mm),  
HT1S301 (PH1 25 mm),  
HT1S302 (PH2 25 mm),  
HT1S303 (PH3 25 mm),
- HT1S307 (PZ0 25 mm),  
HT1S314 (PZ1 25 mm),  
HT1S315 (PZ2 25 mm),  
HT1S316 (PZ3 25 mm),  
HT1S330 (SL4 25 mm),  
HT1S331 (SL5 25 mm),  
HT1S332 (SL6 25 mm),  
HT1S333 (SL8 25 mm),  
HT1S334 (TORX T8 25 mm),  
HT1S335 (TORX T9 25 mm),  
HT1S336 (TORX T10 25 mm),  
HT1S337 (TORX T15 25 mm),  
HT1S338 (TORX T20 25 mm),  
HT1S339 (TORX T25 25 mm),  
HT1S341 (TORX T30 25 mm),  
HT1S342 (TORX T40 25 mm),  
HT1S347 (HEX H3 25 mm),  
HT1S348 (HEX H4 25 mm),  
HT1S349 (HEX H5 25 mm),
- HT1S350 (HEX H6 25 mm),  
HT1S323 (PH0 50 mm),  
HT1S310 (PH1 50 mm),  
HT1S312 (PH3 50 mm),  
HT1S324 (PZ0 50 mm),  
HT1S318 (PZ1 50 mm),  
HT1S319 (PZ2 50 mm),  
HT1S321 (PZ3 50 mm),  
● SL 4 50 mm,  
● SL 5 50 mm,  
● SL 6 50 mm,  
● SL 8 50 mm,  
○ T10 50 mm,  
○ T15 50 mm,  
○ T20 50 mm,  
○ T50 50 mm,  
○ T30 50 mm,  
○ T40 50 mm

HT7G150	39,5 x 18 cm	1	5

x107 1/4" S2 CrV EVA

DE Werkzeugsatz EN Flat ring spanner set with articulated joint FR Jeu de clés mixtes avec un joint ES Juego de llaves combinadas HR Set viljuškasto-okastih ključeva s račnom HU Lapos gyűrűs csavar kulcs csuklóval RO Cheie inelară plată cu balamă BG Комплект гаечен ключ



HT1R048 (8 mm),  
HT1R049 (9 mm),  
HT1R050 (10 mm),  
HT1R051 (11 mm),  
HT1R052 (12 mm),  
HT1R053 (13 mm),  
HT1R054 (14 mm),  
HT1R055 (15 mm),  
HT1R056 (16 mm),  
HT1R057 (17 mm),  
HT1R058 (18 mm),  
HT1R059 (19 mm),  
HT1R060 (20 mm),  
HT1R061 (21 mm)

HT7G147	39,5 x 18 cm	1	5

x14 12PT 15° FLEXIBLE HEAD 72T CrV EVA

DE Werkzeugsatz EN Toolset with ratchet FR Ensemble de 27 pièces avec clé à cliquet ES Juego de llaves fijas con carraca HR Set alata s čegrtaljkom HU Racsnis szerszámkészlet RO Set de scule cu clichet BG Комплект инструменти с тресчотка



HT1A208 (8 mm), HT1A209 (9 mm),  
HT1A210 (10 mm), HT1A211 (11 mm),  
HT1A212 (12 mm), HT1A213 (13 mm),  
HT1A214 (14 mm), HT1A215 (15 mm),  
HT1A216 (16 mm), HT1A217 (17 mm),  
HT1A218 (18 mm), HT1A219 (19 mm),  
HT1A221 (21 mm), HT1A222 (22 mm),  
HT1A224 (24 mm), HT1A227 (27 mm),  
HT1A230 (30 mm), HT1A232 (32 mm),  
HT1A236 (36 mm), HT1A757 (1/2"),  
HT1A727 (1/2", 254 mm),  
HT1R322 (1/2"),  
HT1A785 (1/2", 21 mm),  
HT1A783 (1/2", 16 mm),  
HT1A265 (15 mm),  
HT1A267 (17 mm),  
HT1A269 (19 mm)

HT7G149	39,5 x 18 cm	1	5

x27 1/2" 72T CrV EVA

DE Werkzeugsatz EN Tool set FR Jeu d'outils ES Juego de herramientas HR Set alata HU Szerszámkészlet RO Set de scule BG Изолирани отвертки

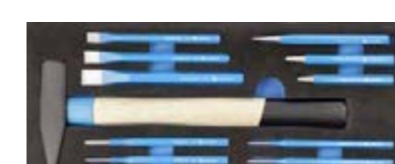

HT3B005 (500 g),  
HT3B712  
(Cold chisels:  
10 x 140 mm,  
12 x 150 mm,  
16 x 170 mm,  
Taper punches:  
1.5 x 150 mm,  
3 x 150 mm,  
4 x 150 mm,  
5 x 150 mm,  
6 x 150 mm,  
8 x 150 mm,  
Centre punches:  
2 x 140 mm,  
6 x 100 mm,  
8 x 115 mm)

HT7G151	39,5 x 18 cm	1	5

x13 CrV EVA

DE Schraubendreher-Satz EN Screwdriver set FR Jeu de tournevis ES Juego de destornilladores HR Set odvijača HU Csavarhúzó készlet RO Set de șurubelniță BG Комплект отвертки



SL HT1S004, HT1S012  
PH HT1S024, HT1S028,  
HT1S029  
PZ HT1S041, HT1S042

HT7G152	39,5 x 18 cm	1	24

x7 EVA



DE Innensechskantschlüssel-Satz EN Hex keys set FR Jeu de clés Allen ES Juego de llaves hexagonales HR Set imbus ključeva HU Hex kulcs készlet RO Set de chei hex BG Комплект имбусни клшчоже



HT1W802, HT1W804, HT1W809  
1/4" 37 mm Hex: HT1S623, HT1S624, HT1S625, HT1S626, HT1S627, HT1S628  
1/4" 37 mm Tamper Torx: HT1S670, HT1S671, HT1S672, HT1S673, HT1S674, HT1S675, HT1S676, HT1S677, HT1S678, HT1S679, HT1S680  
1/4" 37 mm PH: HT1S601, HT1S602, HT1S603  
1/4" 37 mm PZ: HT1S606, HT1S607, HT1S608  
HT1R324 1/4", HT1A740 1/4", HT1A745 1/4"

NEW

HT7G153	39,5 x 18 cm	1	12

x53 EVA

DE Metallbohrer EN Metal drill bits FR Pack de forets à métaux ES Paquete de brocas para metal HR Set svrdala za metal HU Fúrószár készlet fémhez RO Set de burghii pentru metal BG Комплект свредла за бетон



HT6D181 19 pcs:  
1, 1.5, 2, 2.5, 3, 3.5, 4, 4.5, 5, 5.5, 6, 6.5, 7, 7.5, 8, 8.5, 9, 9.5, 10 mm  
HT6D325  
HT8D190  
HT3B665

NEW

HT7G154	39,5 x 18 cm	1	10

x25 EVA

DE Kabelcrimpzangen-Satz EN Cable crimping pliers set FR Jeu de pinces à sertir ES Juego de alicates para prensar cables HR Set klješta za stezanje HU Kábel krimpelő fogó készlet RO Set clești de sertizare cablu BG Комплект клещи за кримпване



HT1P177, wire stripper, PH screwdriver, cable terminal: 50 pcs 0,5-1,5 mm<sup>2</sup>, 50 pcs 2,5 mm<sup>2</sup>, 50 pcs 4-6 mm<sup>2</sup>

NEW

HT7G161	39,5 x 18 cm	1	12

x158 EVA

DE Bremsen-Befestigungswerkzeuge EN Brake fixing tools FR Outils de conduite de frein ES Herramientas para tubos de freno HR Alati za kočioni sustav HU Fékjavító szerszámkészlet RO Instrumente de fixare a frânei BG Инструменти за спирачно жило



HT1P626, HT1P611, HT8G434, HT8G375

NEW

HT7G162	39,5 x 18 cm	1	10

x4 EVA

DE Metall-Trennscheiben-Satz EN Metal cutting discs set FR Jeu de disques de coupe en métal ES Juego de discos de corte de metal HR Set reznih ploča za metal HU Fémvágó tárcsa készlet RO Set discuri de tăiere a metalelor BG Комплект дискове за рязане н метал



HT6D630, HT6D631, HT8D101, HT6D671, HT6D672, HT6D673

NEW

HT7G155	39,5 x 18 cm	1	12

x60 EVA

DE Messwerkzeuge EN Measuring tools FR Outils de mesure ES Herramientas de medición HR Mjerni alati HU Mérőszerszámok RO Unelte de măsură BG Измервателни инструменти



HT4M425, HT4M322, HT4M001-D, HT4C629, HT4C672, HT1E407

NEW

HT7G157	39,5 x 18 cm	1	14

x15 EVA

DE Krawattenzange EN Ties pliers FR Pince à sertir les liens ES Alicates de apriete HR Klješta za stezanje obujmica HU Fogókészlet kábelkötegelőkhöz RO Clești pentru legături de cabluri BG Клещи за кримпване на връзки



HT8G340, HT8G347, HT8G344, HT8G345, HT8G330, HT4R507

NEW

HT7G163	39,5 x 18 cm	1	10

x5 EVA

DE Kugelgelenk-Abzieher EN Ball joint puller FR Extracteurs de joints ES Extractor de juntas HR Izvlakači HU Csapágy lehúzó készlet RO Extractor de rulmenți BG Скоби за лагеря



HT8G225, HT8G226, HT8G231, HT8G232, HT8G240, HT8G230

NEW

HT7G164	39,5 x 18 cm	1	5

x6 EVA

DE Handnietzangen-Satz EN Hand riveter set FR Jeu de rivets ES Juego de remachadoras HR Seta za zakivanje HU Kézi szegescső készlet RO Set de nituitoare de mână BG Колект за нитове



HT2C152, rivets: 2,4 mm 50 pcs, 3,2 mm 50 pcs, 4,0 mm 50 pcs, 4,8 mm 50 pcs

NEW

HT7G158	39,5 x 18 cm	1	10

x201 EVA

DE Werkzeuge für elektriker EN Tools for electricians FR Outils pour electriciens ES Herramientas para electricistas HR Alati za električare HU Villany szerelési szerszámok RO Instrumente pentru electricieni BG Инструменти за елетротехници



HT2C302, HT1E605, HT2C505, HT1P185, HT1E630

NEW

HT7G159	39,5 x 18 cm	1	14

x5 EVA

DE Werkzeug EVA-Schaumstofffüllung für Werkzeugkasten EN EVA filling for drawers FR Doublure EVA pour tiroirs ES Rellenos EVA para cajones HR EVA ispuna za ladice HU EVA fiókbetét RO Umplere sertar EVA BG Вложка EVA за чекмеджета



HT7G160	545 x 400 x 2 mm	7-pack	18

x7 545x400 mm 2 mm EVA

DE Werkzeugkasten EN Modular tool trolley FR Servante à outils ES Carrito de herramientas HR Ladičar za radionicu s kotačima HU Szerszámkocsi RO Căruțior de scule BG Модулна количка за инструменти



3 modules	max 45 kg	1x20 kg 420x220x150 mm
2x5 kg 380x215x80 mm	1x15 kg 410x210x250 mm	
ALU HANDLE	x2	2 COMPARTMENTS

HT7G080	52 x 32 x 72 cm	2	1 1

METAL LOCK

DE Mobile Kiste EN Mobile tool box FR Boîte à outils mobile ES Caja de herramientas móvil HR Mobilna kutija za alate HU Mobil szerszámosláda RO Cutie pentru instrumente mobile BG Мобилна кутия за инструменти

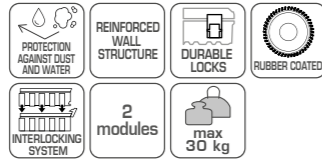

HT7G081	450x360x640	2	1	1
---------	-------------	---	---	---

DE Werkzeugkasten mit 2 Schubladen EN 2-drawer tool box FR Boîte à outils à 2 tiroirs ES Caja de herramientas 2 cajones HR Kutija za alat HU 2 fiókos szerszámosláda RO Cutie cu 2 sertare BG Кутия за инструменти с 2 чекмеджета

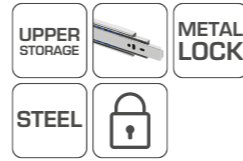

HT7G074	21,8 x 25,5 x 52,0 cm	2	1	1
---------	-----------------------	---	---	---

DE Werkzeugkasten mit 4 Schubladen EN 4-drawer tool box FR Boîte à outils à 4 tiroirs ES Caja de herramientas 4 cajones HR Kutija za alat HU 4 fiókos szerszámosláda RO Cutie cu 4 sertare BG Кутия за инструменти с 4 чекмеджета

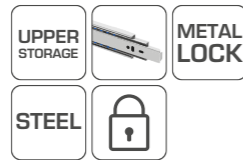

HT7G075	21,8 x 36,0 x 52,0 cm	4	1	1
---------	-----------------------	---	---	---

DE Werkzeugkasten aus Metall EN Metal tool box FR Boîte à outils métallique ES Caja de herramientas metálica HR Metalna kutija za alat HU Fém szerszámodoboz RO Cutie de scule metalice BG Метална кутия за инструменти



HT7G077	45 x 20,5 x 20 cm	18"	5	1	1
---------	-------------------	-----	---	---	---

DE Werkzeugkasten aus Metall EN Metal tool box FR Boîte à outils métallique ES Caja de herramientas metálica HR Metalna kutija za alat HU Fém szerszámodoboz RO Cutie de scule metalice BG Метална кутия за инструменти

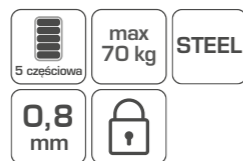

HT7G072	55 x 20,5 x 29,5 cm	20"	5	1	1
---------	---------------------	-----	---	---	---

DE Werkzeugkasten aus Metall EN Metal tool box FR Boîte à outils métallique ES Caja de herramientas metálica HR Metalna kutija za alat HU Fém szerszámodoboz RO Cutie de scule metalice BG Метална кутия за инструменти



HT7G078	53 x 20,5 x 20 cm	21"	5	1	1
---------	-------------------	-----	---	---	---

DE Hermetischer Werkzeugkasten EN Hermetic tool box FR Boîte à outils étanche ES Caja de herramientas hermética HR Hermetička kutija za alat HU Hermetikusan záró szerszámodoboz RO Cutie de instrumente ermetică BG Херметична кутия за инструменти

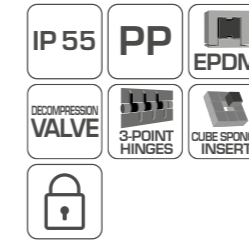

HT7G010	270 x 246 x 124 mm	10,5"	1	12
---------	--------------------	-------	---	----

DE Hermetischer Werkzeugkasten EN Hermetic tool box FR Boîte à outils étanche ES Caja de herramientas hermética HR Hermetička kutija za alat HU Hermetikusan záró szerszámodoboz RO Cutie de instrumente ermetică BG Херметична кутия за инструменти

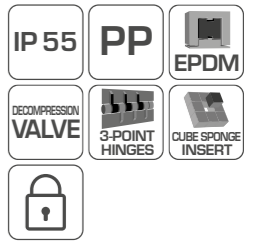

HT7G011	339 x 295 x 152 mm	14"	1	4
---------	--------------------	-----	---	---

DE Hermetischer Werkzeugkasten EN Hermetic tool box FR Boîte à outils étanche ES Caja de herramientas hermética HR Hermetička kutija za alat HU Hermetikusan záró szerszámodoboz RO Cutie de instrumente ermetică BG Херметична кутия за инструменти

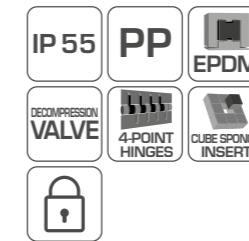

HT7G012	460 x 365 x 176 mm	18,5"	1	2
---------	--------------------	-------	---	---

DE Hermetischer Werkzeugkasten EN Hermetic tool box FR Boîte à outils étanche ES Caja de herramientas hermética HR Hermetička kutija za alat HU Hermetikusan záró szerszámodoboz RO Cutie de instrumente ermetică BG Херметична кутия за инструменти

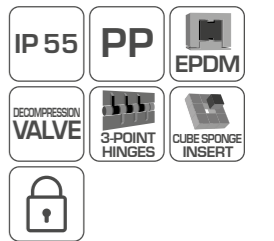

HT7G018	420 x 220 x 340 mm	16,5"	1	2
---------	--------------------	-------	---	---

DE Werkzeugkasten EN Toolbox FR Boîte à outils vide ES Caja de herramientas vacía de pulgadas HR Kutija za alat HU Szerszámosláda RO Trusa de scule BG Кутия за инструменти



HT7G061	470 x 256 x 238	18"	1	1
---------	-----------------	-----	---	---

DE Werkzeugkasten EN Toolbox FR Boîte à outils vide ES Caja de herramientas vacía de pulgadas HR Kutija za alat HU Szerszámosláda RO Trusa de scule BG Кутия за инструменти



HT7G063	540x278x269	22"	1	1
---------	-------------	-----	---	---



DE Werkzeugkasten EN Toolbox FR Boîte à outils vide ES Caja de herramientas vacía de pulgadas HR Kutija za alat HU Szerszámoszláda RO Trusa de scule BG Кутия за инструменти



HT7G066	586x296x305	25"	1	1
---------	-------------	-----	---	---

DE Sortimentskasten EN Storage organizer FR Boîte de rangement ES Caja de almacenamiento HR Organizer HU Rendező RO Organizator BG Кутия органайзер



HT7G033	18 x 9 x 3,5 cm	3,5"	1	120
---------	-----------------	------	---	-----



DE Sortimentskasten EN Storage organizer FR Boîte de rangement ES Caja de almacenamiento HR Organizer HU Rendező RO Organizator BG Кутия органайзер



HT7G034	20 x 16 x 3,5 mm	7,5"	1	64
---------	------------------	------	---	----



DE Sortimentskasten EN Storage organizer FR Boîte de rangement ES Caja de almacenamiento HR Organizer HU Rendező RO Organizator BG Кутия органайзер



HT7G022	29 x 19,5 x 3,5 cm	12"	1	60
---------	--------------------	-----	---	----

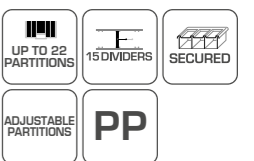

DE Sortimentskasten EN Storage organizer FR Boîte de rangement ES Caja de almacenamiento HR Organizer HU Rendező RO Organizator BG Кутия органайзер



HT7G024	34,4 x 24,9 x 5 cm	14"	1	10
---------	--------------------	-----	---	----

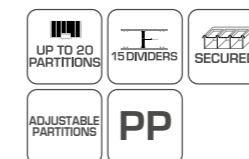

DE Sortimentskasten EN Storage organizer FR Boîte de rangement ES Caja de almacenamiento HR Organizer HU Rendező RO Organizator BG Кутия органайзер



HT7G026	39,9 x 30,3 x 5 cm	16"	1	10
---------	--------------------	-----	---	----

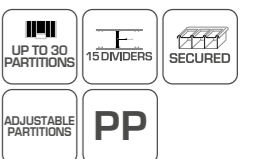

## MARKETING SUPPORT

Wir bieten attraktive Aktionen, Treueprogramme, Schulungen. In jeder Phase der Zusammenarbeit stellen wir unseren Distributoren die erforderlichen Mittel zur Verfügung, um den Verkauf und die Präsentation des Produkts zu unterstützen:

- Regale;
- Displays;
- Drucksachen und Verkaufspunkt Materialien.

Wir arbeiten mit Vertriebspartnern auch individuell zusammen, je nach Potenzial und Bedarf des Kunden, und bieten Branding auf Baustellen, Aufzügen, Autos, Flaggen und Werbetafeln an. Wir sind immer offen für neue Ideen unserer Geschäftspartner. Unseren Distributoren steht außerdem eine umfangreiche Vertriebsabteilung zur Verfügung, die jederzeit für Unterstützung zur Verfügung steht.

## MARKETING SUPPORT

We provide attractive promotions, loyalty programs and training. At each step of our cooperation, we provide necessary tools and product display stands to support sales:

- free-standing racks;
- displays and cardboard stands;
- printed materials and POS.

We also work with Distributors individually, according to the customer's potential and needs, offering branding on display windows, facades, cars, flags and billboards. We are always open to new ideas of our Business Partners. Additionally we have an extensive Sales Department at our Distributors' disposal, which always provides support.

### Offene Ausstellungsregale

Maße: **100 x 250 x 55 cm** oder **60 x 250 x 55 cm**.

Maße: **50 x 203 x 50 cm**.

Für die Regale wurde zusätzliches Zubehör entworfen: Regalböden, Balken, Haken, Bügel und Schienen, die es ermöglichen, die Produkte zu kategorisieren und Waren verschiedener Größen zu präsentieren.



### Display and sales racks (open)

Dimensions: **100 x 250 x 55 cm** or **60 x 250 x 55 cm**.

Dimensions: **50 x 203 x 50 cm**.

Additional accessories have been designed for the racks: shelves, beams, hooks, hangers and strips, which allow you to categorize products and display goods of various sizes.



### Geschlossene Ausstellungsregale

Maße: **100 x 250 x 55 cm** oder **60 x 250 x 55 cm**.

Regale mit diebstahlsicheren Türen.

### Displays für Bohrer und Bits

Maße: **32 x 60 x 100 cm**.

Maße: **19,2 x 19,2 x 78,5 cm**.

Metallkonstruktion.



### Drills and bits displays

Dimensions: **32 x 60 x 100 cm**.

Dimensions: **19,2 x 19,2 x 78,5 cm**.

Metal construction.



### Displays für Wasserwaagen

Maße: **33 x 29 x 111 cm**.

Metallkonstruktion mit Platz für 18 Wasserwaagen.



### Displays for spirit levels

Dimensions: **33 x 29 x 111 cm**.

Metal construction with space for 18 spirit levels.



### Displays aus Pappe

Maße: **60 x 140 x 40 cm**.

Nutzlast: **80 kg**.



### Cardboard displays

Dimensions: **60 x 140 x 40 cm**.

Load capacity up to: **80 kg**.



### Produkt-Minidisplays – für den Kassentisch

Es besteht die Möglichkeit, Produkte auf dem Tisch oder direkt an der Kasse auszustellen.

### Mini product displays - counters

You can display products on the counter or directly near the cash register.

## SOUTIEN MARKETING

Nous proposons des promotions avantageuses, des programmes de fidélisation, des formations. À chaque étape de la coopération, nous fournissons à nos distributeurs les outils nécessaires pour soutenir les ventes et la présentation des produits:

- Étagères;
- Présentoirs;
- matériel imprimé et PLV.

Nous coopérons également avec les distributeurs de manière personnalisée, en fonction du potentiel et de la demande du client, en proposant des marquages sur les vitrines, les façades, les voitures, les drapeaux, les panneaux publicitaires. Nous sommes toujours ouverts aux nouvelles idées venant de nos partenaires commerciaux. Nous disposons également d'un département de vente à la disposition de nos distributeurs, qui fournit toujours le soutien nécessaire.

## APOYO AL MARKETING

Ofrecemos atractivas promociones, programas de fidelización y formación. En cada etapa de la colaboración proporcionamos a nuestros distribuidores las herramientas de apoyo a ventas así como la correcta exposición de los productos:

- Vitrinas;
- Expositores;
- material impreso y PLV.

Trabajamos también con los distribuidores de forma individual, según el potencial y las necesidades del cliente, ofreciendo el branding en escaparates, fachadas, coches, banderas, vallas publicitarias. Siempre estamos abiertos a nuevas ideas de nuestros socios comerciales. Al mismo tiempo ponemos a disposición de los distribuidores nuestro equipo de ventas para que los apoye.

### Rayonnages de présentation-vente ouverts

Dimensions: **100 x 250 x 55 cm** ou **60 x 250 x 55 cm**.

Dimensions: **50 x 203 x 50 cm**.

Des accessoires supplémentaires ont été conçus pour les rayonnages: étagères, piliers, crochets, attaches et baguettes, lesquels permettent de classer et d'exposer des produits de différentes tailles.



### Rayonnages de présentation-vente fermés

Dimensions: **100 x 250 x 55 cm** ou **60 x 250 x 55 cm**.

Rayonnages à portes sécurisées contre le vol.



### Présentoirs de forets et de mèches

Dimensions: **32 x 60 x 100 cm**.

Dimensions: **19,2 x 19,2 x 78,5 cm**.

Structure métallique.



### Présentoirs à niveaux

Dimensions: **33 x 29 x 111 cm**.

Structure métallique pour 18 niveaux.

### Présentoirs en carton

Dimensions: **60 x 140 x 40 cm**.

Capacité de chargement: 80 kg.

### Mini-présentoirs de produits – comptoirs

Possibilité de présenter les produits sur le comptoir ou directement à la caisse.

### Expositores de punto de venta abiertos

Dimensions: **100 x 250 x 55 cm** o **60 x 250 x 55 cm**.

Dimensions: **50 x 203 x 50 cm**.

Se han diseñado accesorios adicionales para las estanterías: estantes, vigas, ganchos, colgadores y rieles que permiten clasificar los productos y exponer mercancías de distintos tamaños.



### Expositores de punto de venta cerrados

Dimensions: **100 x 250 x 55 cm** o **60 x 250 x 55 cm**.

Expositores con puertas antirrobo.



### Expositores de brocas y puntas

Dimensions: **32 x 60 x 100 cm**.

Dimensions: **19,2 x 19,2 x 78,5 cm**.

Construcción de metal.

### Expositores de nivel

Dimensions: **33 x 29 x 111 cm**.

Construcción de metal con espacio para 18 niveles de burbuja.

### Expositores de cartón

Dimensions: **60 x 140 x 40 cm**.

Carga útil: 80 kg.

### Miniexpositores de productos – mostrador

Possibilidad de exponer los productos en el mostrador o directamente en la caja registradora.



## MARKETINGŠKA PODRŠKA

pripravljamo atraktivne promocije, programe odanosti, edukacije. U svakoj fazi suradnje našim distributerima pružamo potrebne alate za potporu prodaji i izložbu proizvoda:

- police;
- displeji;
- tiskani materijali i POS.

Našim distributerima također pristupamo individualno, u skladu s njihovim potencijalom i potrebama, nudeći pomoć u pripremi izloga, brendiranja na zgradama, automobilima, zastavama i reklamnim panoima. Uvijek smo otvoreni za nove ideje naših poslovnih partnera. Našim distributerima također na raspolaganju stoji opsežni Odjel Prodaje.

## MARKETINGTAMOĞATÁS

Vonzó kedvezményeket, hűségprogramokat és oktatásokat biztosítunk. Az együttműködés minden szakaszában forgalmazóink rendelkezésére bocsátjuk a termékek értékesítéséhez és megjelenítéséhez szükséges eszközöket:

- polcos állványokat,
- kiállítási eszközöket,
- nyomtatott anyagokat és POS anyagot.

A forgalmazókkal egyénileg is együttműködünk, az ügyfelek potenciáljának és igényeinek megfelelően, márkamegjelenítést kínálva a kirakatokban, a homlokzatokon, autókon, zászlókon, hirdetőablakon. Mindig nyitottak vagyunk Üzleti Partnereink új ötleteire. Forgalmazóink rendelkezésére bocsátunk egy kiterjedt Értékesítési Osztályt is, amely mindig támogatást nyújt szükség esetén.

### Regali za izlaganje i prodaju otvorenog tipa

Dimenzije: 100 x 250 x 55 cm ili 60 x 250 x 55 cm.

Dimenzije: 50 x 203 x 50 cm.

Za regale je predviđeni dodatni pribor: police, grede, kuke, vješalice i trake, koji omogućuju kategoriziranje proizvoda i izlaganje robe različitih veličina.



### Regali za izlaganje i prodaju zatvorenog tipa

Dimenzije: 100 x 250 x 55 cm ili 60 x 250 x 55 cm.

Regali s vratima protiv krađe.



### Izložbene police za svrdla i bitove

Dimenzije: 32 x 60 x 100 cm.

Dimenzije: 19,2 x 19,2 x 78,5 cm.

Metalna konstrukcija.



### Izložbene police za libele

Dimenzije: 33 x 29 x 111 cm.

Metalna konstrukcija s prostorom za 18 libela.

### Kartonske izložbene police

Dimenzije: 60 x 140 x 40 cm.

Nosivost 80 kg.

### Mini izložbene police – za pult

Mogućnost izlaganja proizvoda na pultu ili izravno pored blagajne.

### Nyitott értékesítési állványok

Méretük: 100 x 250 x 55 cm vagy 60 x 250 x 55 cm.

Méretük: 50 x 203 x 50 cm.

Az állványokhoz további tartozékok rendelhetők: polcok, gerendák, kampók, akasztók és sínek, amelyek lehetővé teszik a termékek kategorizálását és különböző méretű áruk megjelenítését.

### Zárt értékesítési állványok

Méretük: 100 x 250 x 55 cm vagy 60 x 250 x 55 cm.

Lopásgátló ajtókkal ellátott polcok.

### Fúrószár és bit állványok

Méretük: 32 x 60 x 100 cm.

Méretük: 19,2 x 19,2 x 78,5 cm.

Fém szerkezet.

### Vízmérték állványok

Méretük: 33 x 29 x 111 cm.

Fém szerkezet, 18 vízmérték helytel

### Karton állványok

Méretük: 60 x 140 x 40 cm.

Terhelhetőség: 80 kg.

### Pultra helyezhető mini termékínálók

Lehetőséget nyújt a termékek pulton vagy közvetlenül a pénztárgépnél történő megjelenítésére.





## SUPPORT DE MARKETING

Oferim promoții atractive, programe de loialitate, cursuri de formare. În fiecare etapă de cooperare, oferim Distribuitorilor noștri instrumentele necesare pentru a susține vânzarea și expunerea produsului:

- rafturi,
- echipamente pentru expunere,
- materiale tipărite și materiale POS.

Lucrăm cu Distribuitorii și în mod individual, în funcție de potențialul și cererea Clientului, oferind branding pe vitrine, fațade, mașini, steaguri, panouri publicitare. Suntem întotdeauna deschiși noilor idei ale Partenerilor noștri de afaceri. Avem la dispoziția Distribuitorilor noștri, și un Departament de Vânzări extins, care este întotdeauna disponibil pentru suport.

## МАРКЕТИНГОВА ПОДКРЕПА

Предлагаме атрактивни промоции, програми за лоялност и обучения. На всеки етап от сътрудничеството предоставяме необходимите инструменти в подкрепа на продажбите и излагането на продукти:

- свободно стоящи стелажки;
- дисплеи и картонени стойки;
- печатни материали и ПОС.

Ние също работим с индивидуално дистрибутори, според потенциала и нуждите на клиента, предлагайки брандиране на витрини, фасади, автомобили, знамена и билбордове. Винаги сме отворени на нови идеи на нашите бизнес партньори. На разположение на нашите дистрибутори имаме голем отдел Продажба, който винаги осигурява подкрепа.

### Рафтuri deschise pentru expunere a produselor

Dimensiuni: **100 x 250 x 55 cm** sau **60 x 250 x 55 cm**.

Dimensiuni: **50 x 203 x 50 cm**.

Pentru rafturi au fost concepute accesorii suplimentare: polițe, grinzi, cârlige, umerase și șine care permit clasificarea produselor și expunerea mărfurilor de diferite dimensiuni.



### Рафтuri închise pentru expunere a produselor

Dimensiuni: **100 x 250 x 55 cm** sau **60 x 250 x 55 cm**.

Рафтuri cu uși antifurt.



### Expozitoare pentru burghie și biți

Dimensiuni: **32 x 60 x 100 cm**.

Dimensiuni: **19,2 x 19,2 x 78,5 cm**.

Structură metalică.



### Expozitoare pentru dreptare

Dimensiuni: **33 x 29 x 111 cm**.

Construcție metalică cu spațiu pentru 18 nivele cu bulă de aer.

### Expozitoare din carton

Dimensiuni: **60 x 140 x 40 cm**.

Capacitate de încărcare: 80 kg.

### Mini-expozitoare de produse – pe teighea

Posibilitatea de a expune produsele pe teighea sau direct la casa de marcat.

### Стелажки и дисплеи отворени

Размери: **100 x 250 x 55 cm** или **60 x 250 x 55 cm**.

Размери: **50 x 203 x 50 cm**.

За стелажките са проектирани допълнителни аксесоари: рафтове, греди, куки, закачалки и ленти, които ви позволяват да категоризирате продуктите и да показвате стока с различни размери.



### Стелажки и дисплеи затворени

Размери: **100 x 250 x 55 cm** или **60 x 250 x 55 cm**.

Стелажки с врати против кражба.



### Дисплеи за свредла и битове

Размери: **32 x 60 x 100 cm**.

Размери: **19,2 x 19,2 x 78,5 cm**.

Метална конструкция.

### Дисплеи за нивелири

Размери: **33 x 29 x 111 cm**.

Метална конструкция с място за 18 нивелири.

### Картонени дисплеи

Размери: **60 x 140 x 40 cm**.

Товароносимост: 80 кг.



### Мини продуктови дисплеи – гишета

Възможност за излагане на продукти на гише или директно в касата.





**DE** Kunststoff **EN** Plastic **FR** Plastique **ES** Plástico **HR** Sinteti-ka **HU** Müanyag **RO** Plastic **BG** Материал



**DE** Aluminium **EN** Aluminum **FR** Aluminium **ES** Aluminio **HR** Aluminij **HU** Alumínium **RO** Aluminiu **BG** Алюминий



**DE** Aluminium-Griff **EN** Aluminum handle **FR** Poignée **EN** alu-minium **ES** Asa de aluminio **HR** Aluminjska ručka **HU** Alumínium fogantyú **RO** Suport din aluminiu **BG** Алюминиева дръжка



**DE** ABS-Griff **EN** ABS handle **FR** Poignée **EN** ABS **ES** Asa de ABS **HR** Ručka od ABS **HU** ABS fogantyú **RO** Măner ABS **BG** Дръжка от ABS



**DE** Aluminium-Gehäuse **EN** Aluminum housing **FR** Boîtier **EN** aluminium **ES** Carcasa de aluminio **HR** Aluminjsko kućište **HU** Alumínium burkolat **RO** Carcasă din aluminiu **BG** Алюминиев корпус



**DE** Nietmaschinegehäuse aus Aluminium **EN** Aluminum riveter housing **FR** Boîtier **EN** aluminium de riveteuse **ES** Carcasa de aluminio para remachadora **HR** Aluminjsko kućište klješta za zakivanje **HU** Alumínium szegeszélszerszám burkolat **RO** Carcasă din aluminiu pentru unalta de nituit **BG** Алюминиев корпус за нитове



**DE** Heftergehäuse aus Aluminium **EN** Aluminum riveter housing **FR** Boîtier **EN** aluminium d'agrafeuse **ES** Carcasa de grapadora de aluminio **HR** Aluminjsko kućište klemarice **HU** Alumínium tűzőgép burkolat **RO** Carcasă pentru capsator **BG** Алюминиев корпус за телбод



**DE** Aluminium-Messergriff **EN** Aluminum knife's handle **FR** Manche de couteau **EN** aluminium **ES** Mango del cuchillo de aluminio **HR** Aluminjska ručka noža **HU** Alumínium kés nyél **RO** Măner de cuțit din aluminiu **BG** Алюминиева дръжка за нож



**DE** Aluminium-Schaumpistolengehäuse **EN** Foam gun body **FR** Aluminium **FR** Corps du pistolet à mousse **EN** aluminium **ES** Cuerpo de la pistola de espuma de aluminio **HR** Aluminjsko tijelo **HU** Alumínium habzópisztoly ház **RO** Corpul pistolului pentru spumă din aluminiu **BG** Алюминиев корпус на pistol за пяна



**DE** Sägerahmen aus Aluminium **EN** Aluminum saw frame **FR** Cadre de scie **EN** aluminium **ES** Marco de sierra de aluminio **HR** Aluminjski okvir pile **HU** Alumínium fűrész keret **RO** Cadru de ferăstrău din aluminiu **BG** Алюминиева рамка за трион



**DE** Aluminium-Griff **EN** Aluminum handle **FR** Manche **EN** aluminium **ES** Asa de aluminio **HR** Aluminjska ručka **HU** Alumínium fogantyú **RO** Măner din aluminiu **BG** Алюминиева дръжка



**DE** Aluminium-Kistenverschluss **EN** Aluminum box latch **FR** Loquet de boîte **EN** aluminium **ES** Cierre de caja de aluminio **HR** Aluminjska zaklopka kutije **HU** Alumínium doboz retesz **RO** Incuietoare din aluminiu pentru cutie **BG** Алюминиев резе за кутия



**DE** Aluminium-Verschlüsse **EN** Aluminum clasps **FR** Fermoirs **EN** aluminium **ES** Cierres de aluminio **HR** Aluminjske korpce **HU** Alumínium kapcsok **RO** Inchizători din aluminiu **BG** Алюминиеви закопчалки



**DE** Aluminium- und Kupferkabel **EN** Aluminum and copper cables **FR** Câbles **EN** aluminium et **EN** cuivre **ES** Cables de aluminio y cobre **HR** Aluminjski i bakreni kablovi **HU** Alumínium és réz kábelek **RO** Cabluri din aluminiu și cupru **BG** Алюминиеви и медни кабели



**DE** Aluminium- und Kupferrohre **EN** Aluminum and copper pipes **FR** Tubes **EN** aluminium et **EN** cuivre **ES** Tubos de aluminio y cobre **HR** Aluminjske i bakrene cijevi **HU** Alumínium és réz csövek **RO** Ţevi din aluminiu și cupru **BG** Алюминиеви и медни тръби



**DE** Einnietmutter aus Aluminium **EN** Aluminum rivet nuts **FR** Écrous à rivets **EN** aluminium **ES** Tuercas remachables de aluminio **HR** Aluminjske zakivne matice **HU** Alumínium szegeszanyág **RO** Piułițe nituite din aluminiu **BG** Алюминиеви гайки



**DE** Gehäuse aus Aluminium-Verbundwerkstoff **EN** Aluminum rivet nuts **FR** Boîtier **EN** composite et aluminium **ES** Carcasa de aluminio compuesto **HR** Aluminjsko-kompozitno kućište **HU** Alumínium-kompozit borítás **RO** Carcasă din aluminiu-compozit **BG** Алюминиево-кополитен



**DE** Aluminiumguss **EN** Die-cast aluminum **FR** Fonte d'aluminium **ES** Fundición a presión de aluminio **HR** Aluminjski odjevjak **HU** Alumínium öntvény **RO** Aluminiu turnat **BG** Алюминиева форма



**DE** Werkstoff Al Cu **EN** Al Cu material **FR** Matériau Al Cu **ES** Material Al Cu **HR** Materijal Al Cu **HU** Al Cu anyag **RO** Material Al Cu **BG** Материал Al Cu



**DE** Zwei Metalle oder Metalllegierungen kombiniert **EN** Combined two metals or metal alloys **FR** Deux métaux ou alliages de métaux combinés **ES** Dos metales o aleaciones metálicas combinadas **HR** Kombinacija dva metala ili dviju metalnih legura **HU** Két fém vagy fémötvözet kombinációja **RO** Două metale sau aliaje metalice combinate **BG** Свързани два метала или метални сплави



**DE** Bi-Metall-Klinge **EN** Bi-metal saw blade **FR** Lame bi-métal **ES** Hoja de sierra bimetalica **HR** Bimetal list za pile **HU** Bi-fém lap **RO** Pânză bimetalică **BG** Биметален трион



**DE** Bi-Metall-Klingen M2 **EN** M2 bi-metal blades **FR** Lames bi-métal M2 **ES** Cuchillas bimetalicas M2 **HR** Bimetal M2 oštrice **HU** M2 bimetal pengék **RO** Lame bimetalice M2 **BG** Биметален ръб M2



**DE** Bi-Metall-Klingen M42 **EN** M42 bi-metal blades **FR** Lames bi-métal M42 **ES** Cuchillas bimetalicas M42 **HR** Bimetal M42 oštrice **HU** M42 bimetal pengék **RO** Lame bimetalice M42 **BG** Биметален ръб M42



**DE** Messing **EN** Brass **FR** Laiton **ES** Latón **HR** Mesing **HU** Sár-garéz **RO** Alamă **BG** Месинг



**DE** Hartmetall **EN** Carbide **FR** Carbuire **ES** Carburo **HR** Karbid **HU** Karbid **RO** Carbură **BG** Карбид



**DE** Gusseisen **EN** Cast iron **FR** Fonte **ES** Hierro fundido **HR** Lije-vano željezo **HU** Öntöttvas **RO** Fontă **BG** Материал желязо



**DE** Material Gusseisen **EN** Cast iron material **FR** Matériau : fonte **ES** Material Hierro fundido **HR** Materijal lijevano željezo **HU** Öntöttvas anyag **RO** Material fontă **BG** Чугунен материал



**DE** Kupfer **EN** Copper **FR** Cuivre **ES** Cobre **HR** Bakar **HU** Réz **RO** Cupru **BG** Мед



**DE** Kupfer, Nickel, Zink **EN** Copper, nickel, zinc **FR** Cuivre, nickel, zinc **ES** Cobre, níquel, zinc **HR** Bakar, nikel, cink **HU** Réz, nikkel, cink **RO** Cupru, nichel, zinc **BG** Мед, никел, цинк



**DE** Keramik **EN** Ceramics **FR** Céramique **ES** Cerámica **HR** Kera-mika **HU** Kerámia **RO** Ceramică **BG** Керамика



**DE** Kobalt **EN** Cobalt **FR** Cobalt **ES** Cobalto **HR** Kobalt **HU** Kobalt **RO** Cobalt **BG** Кобалт



**DE** 5% Kobalt **EN** 5% cobalt **FR** 5% de cobalt **ES** 5% de cobalto **HR** 5% kobalta **HU** 5% kobalt **RO** 5% cobalt **BG** 5% кобалт



**DE** 8% Kobalt **EN** 8% cobalt **FR** 8% de cobalt **ES** 8% de cobalto **HR** 8% kobalta **HU** 8% kobalt **RO** 8% cobalt **BG** 8% кобалт



**DE** Beton **EN** Concrete **FR** Béton **ES** Hormigón **HR** Beton **HU** Beton **RO** Beton **BG** Бетон



**DE** Stahl **EN** steel **FR** Acier **ES** Acero **HR** Čelik **HU** Acél **RO** Oțel **BG** Стомана



**DE** Stahl-Schlagbolzen **EN** Steel spire **FR** Percuteur **EN** acier **ES** Aguja de acero **HR** Čelična iglica **HU** Acél tű **RO** Percutor din oțel **BG** Стоманен шпил



**DE** Stahldüse **EN** nozzle **FR** Buse **EN** acier **ES** Boquilla de acero **HR** Čelična mlaznica **HU** Acél fúvóka **RO** Duză din oțel **BG** Стоманена дюза



**DE** Metallscharniere **EN** Metal hinges **FR** Charnières **EN** métal **ES** Bisagras metálicas **HR** Metalne šarke **HU** Fém zsanérok **RO** Balamale metalice **BG** Метални панти



**DE** Stahlband **EN** Steel tape **FR** Ruban **EN** acier **ES** Correa de acero **HR** Čelična traka **HU** Acél szalag **RO** Bandă din oțel **BG** Стоманена лента



**DE** Stahlband **EN** Steel tape **FR** Ruban **EN** acier **ES** Correa de acero **HR** Čelična traka **HU** Acél szalag **RO** Bandă din oțel **BG** Стоманена лента



**DE** Stahlband **EN** Steel tape **FR** Ruban **EN** acier **ES** Correa de acero **HR** Čelična traka **HU** Acél szalag **RO** Bandă din oțel **BG** Стоманена лента



**DE** Stahl und Inox **EN** Steel and inox **FR** Acier et inox **ES** Acero e inox **HR** Čelik i inox **HU** Acél és inox **RO** Oțel și inox **BG** Стомана и иннок



**DE** Art von Stahl **EN** Type of steel **FR** Type d'acier **ES** Tipo de acero **HR** Vrsta čelika **HU** Acél típus **RO** Tipul de oțel **BG** Вид стомана



**DE** Material Stahl **EN** Material steel **FR** Matériau: acier **ES** Material acero **HR** Materijal čelik **HU** Acél anyag **RO** Material oțel **BG** Материал стомана



**DE** INOX-Material **EN** INOX material **FR** Matériau INOX **ES** Material INOX **HR** Materijal INOX **HU** INOX anyag **RO** Material INOX **BG** INOX материал



**DE** Material Stahl, PVC **EN** Material steel, PVC **FR** Matériau : acier, PVC **ES** Material acero, PVC **HR** Materijal čelik, PVC **HU** Acél, PVC anyag **RO** Material oțel, PVC **BG** Материал стомана, PVC



**DE** Klinge aus SK5-Stahl **EN** SK5 steel blade **FR** Lame **EN** acier SK5 **ES** Hoja de acero SK5 **HR** Oštrica od SK5 čelika **HU** SK5 acél penge **RO** Lamă fabricată din oțel SK5 **BG** Стоманено острие SK5



**DE** Schneidmesser aus SK5-Stahl **EN** Cutting blade made of SK5 steel **FR** Lame de coupe **EN** acier SK5 **ES** Cuchilla de corte de acero SK5 **HR** Rezna oštrica od SK5 čelika **HU** SK5 acél vágó penge **RO** Lamă de tăiere din oțel SK5 **BG** Режущее острие от стомана SK5



**DE** Klinge aus Cr12MoV-Stahl **EN** Cr12MoV steel blade **FR** Lame **EN** acier Cr12MoV **ES** Hoja de acero Cr12MoV **HR** Oštrica od Cr-12MoV čelika **HU** Cr12MoV acél penge **RO** Lamă fabricată din oțel Cr12MoV **BG** Стоманено острие Cr12MoV



**DE** Chrom-Molybdän-Legierter Stahl **EN** Chrome molybdenum alloy steel **FR** Acier allié au chrome-molybdène **ES** Acero de aleación de cromo-molibdeno **HR** Čelik od legure krom molibdena **HU** Króm-molibdén ötvözetből készült penge **RO** Oțel din aliaj de cromo-molibden **BG** Хромирана молибденова легирана стомана



**DE** Ratschenmechanismus aus Chrom-Molybdän-Legierung **EN** Chrome-molybdenum alloy ratchet mechanism **FR** Mécanisme du cliquet **EN** alliage chrome-molybdène **ES** Mecanismo de trinquete de acero de aleación de cromo-molibdeno **HR** Mehaniizam čegrtaljke od legiranog čelika od krom molibdena **HU** Króm-molibdén ötvözetből készült racsnis mechanizmus **RO** Mecanism cu clichet din aliaj de cromo-molibden **BG** Храпови механизъм от хром-молибденова сплав



**DE** Dreifach-Backen aus Chrom-Molybdän-Legierung **EN** Triple jaws made of chrome-molybdenum alloy steel **FR** Mâchoires triples **EN** acier allié chrome-molybdène **ES** Mordazas de acero de triple aleación de cromo-molibdeno **HR** 3 čeljusti od legirana čelika od krom molibdena **HU** Króm-molibdén ötvözetből készült tripla pofa **RO** Fălci triple din aliaj de oțel cu cromo-molibden **BG** Тройни стъги, изработени от легирана стомана от хром-молибден



**DE** Chrom-Nickel-Stahl **EN** Chrome-nickel alloy steel **FR** Acier allié au chrome-nickel **ES** Acero de aleación de cromo-níquel **HR** Legirani čelik krom-nikal **HU** Króm-nikkel ötvözetű acél **RO** Oțel aliat crom-nichel **BG** Легирана стомана от хром-никел



**DE** Dreifach-Backen aus Chrom-Molybdän-Legierung **EN** Triple jaws made of chrome-molybdenum alloy steel **FR** Mâchoires triples **EN** acier allié chrome-molybdène **ES** Mordazas de acero de triple aleación de cromo-molibdeno **HR** 3 čeljusti od legirana čelika od krom molibdena **HU** Króm-molibdén ötvözetből készült tripla pofa **RO** Fălci triple din aliaj de oțel cu cromo-molibden **BG** Тройни стъги, изработени от легирана стомана от хром-молибден



**DE** Chrom-Vanadium-Stahl **EN** Chrome vanadium alloy steel **FR** Acier allié au chrome-vanadium **ES** Acero de aleación de cromo-vanadio **HR** Krom-vanadijev legirani čelik **HU** Króm-vanádium ötvözetű acél **RO** Oțel aliat cu cromo-vanadiu **BG** Хром-ванадиева легирана стомана



**DE** Klinge aus Kohlenstoffstahl C45 **EN** C45 carbon steel head **FR** Tête **EN** acier au carbone C45 **ES** Hoja de acero al carbono C45 **HR** Glava od ugljičnog čelika C45 **HU** Szénacéliből készült C45 penge **RO** Cap din oțel carbon C45 **BG** Форма от въглеродна стомана C45



**DE** Glas **EN** Glass **FR** Verre **ES** Vidrio **HR** Staklo **HU** Üveg **RO** Sticlă **BG** Стькло























**DE** Legierter Hochgeschwindigkeitsstahl **EN** High speed cut alloy steel **FR** Acier allié à haute vitesse **ES** Acero aleado de alta velocidad **HR** Brzorezni legirani čelik **HU** Gyorsvágó ötvöztött acél **RO** Oțel aliat pentru tăiere de mare viteză **BG** Легирана стомана с висока скорост























**DE** Inox **EN** Inox **FR** Inox **ES** Inox **HR** Inox **HU** Inox **RO** Inox **BG** Inox















**DE** Leder **EN** Leather **FR** Cuir **ES** Cuero **HR** Koža **HU** Bőr **RO** Piele **BG** Кожа

	<b>DE</b> Nagel <b>EN</b> Nail <b>FR</b> Clou <b>ES</b> Clavo <b>HR</b> Čavao <b>HU</b> Szög <b>RO</b> Cui <b>BG</b> Пирон
	<b>DE</b> Nylon <b>EN</b> Nylon <b>FR</b> Nylon <b>ES</b> Nylon <b>HR</b> Najlon <b>HU</b> Nejlon <b>RO</b> Nailon <b>BG</b> Найлон
	<b>DE</b> Nylonbeschichtetes Band <b>EN</b> Tape coated with nylon <b>FR</b> Ruban recouvert de nylon <b>ES</b> Correa recubierta de nylon <b>HR</b> Traka prekrivena najlonom <b>HU</b> Nylon bevonatú szalag <b>RO</b> Bandă acoperită cu nailon <b>BG</b> Лента с винилово покритие
	<b>DE</b> Vinylbeschichtetes Band <b>EN</b> Tape coated with vinyl <b>FR</b> Ruban recouvert de vinyle <b>ES</b> Cinta con revestimiento de vinilo <b>HR</b> Traka prekrivena vinilom <b>HU</b> Vinil bevonatú szalag <b>RO</b> Bandă acoperită cu vinil <b>BG</b> Лента с винилово покритие
	<b>DE</b> Stahlband <b>EN</b> Steel tape <b>FR</b> Ruban <b>EN</b> acier <b>ES</b> Correa de acero <b>HR</b> Čelična traka <b>HU</b> Acél szalag <b>RO</b> Bandă din oțel <b>BG</b> Стоманена лента
	<b>DE</b> Aluminiumlegierung <b>EN</b> Aluminum alloy <b>FR</b> Alliage d'aluminium <b>ES</b> Aleación de aluminio <b>HR</b> Aluminijska legura <b>HU</b> Alumínium ötvözet <b>RO</b> Aliaj de aluminiu <b>BG</b> Алюминиева сплав
	<b>DE</b> Polyethylen <b>EN</b> Polyethylene <b>FR</b> Polyéthylène <b>ES</b> Polietileno <b>HR</b> Polietilen <b>HU</b> Polietilén <b>RO</b> Polietilenă <b>BG</b> Полиетилен
	<b>DE</b> Backen aus Polyethylen <b>EN</b> Polyethylene jaws <b>FR</b> Mâchoires <b>EN</b> polyéthylène <b>ES</b> Moldazas de polietileno <b>HR</b> Polietilenske čeljusti <b>HU</b> Polietilén pókak <b>RO</b> Fălci din polietilenă <b>BG</b> Полиетиленови стъги
	<b>DE</b> Rohre aus Polyethylen und Aluminium <b>EN</b> Polyethylene and aluminum pipes <b>FR</b> Tubes EN polyéthylène et EN aluminium <b>ES</b> Tubos de polietileno y aluminio <b>HR</b> Polietilenske i aluminijske cijevi <b>HU</b> Polietilén és alumínium csövek <b>RO</b> Jevi din polietilenă și aluminiu <b>BG</b> Полиетиленови и алуминиеви тръби
	<b>DE</b> Polyethylen-Kombination <b>EN</b> Polyethylene combination <b>FR</b> Combinaison de polyéthylène <b>ES</b> Combinación de polietileno <b>HR</b> Polietilenska kombinacija <b>HU</b> Polietilén kombináció <b>RO</b> Combinație de polietilenă <b>BG</b> Комбинация от полиетилен
	<b>DE</b> Polyethylen-Aluminium-Kombination <b>EN</b> Polyethylene combination with aluminum <b>FR</b> Combinaison polyéthylène-aluminium <b>ES</b> Combinación de polietileno y aluminio <b>HR</b> Kombinacija polietilena i aluminja <b>HU</b> Polietilén és alumínium kombináció <b>RO</b> Combinație de polietilenă cu aluminiu <b>BG</b> Комбинация от полиетилен и алуминий
	<b>DE</b> PTFE-beschichtete Schutzschicht <b>EN</b> PTFE coated shell <b>FR</b> Revêtement enduit de PTFE <b>ES</b> Revestimiento de PTFE <b>HR</b> Površina premazana PTFE-om <b>HU</b> PTFE bevonattal ellátott bevonat <b>RO</b> Acoperire cu strat de PTFE <b>BG</b> Копрус с PTFE покритие
	<b>DE</b> Kunststoff <b>EN</b> Plastic <b>FR</b> Plastique <b>ES</b> Plástico <b>HR</b> Plastika <b>HU</b> Műanyag <b>RO</b> Plastic <b>BG</b> Пластмаса
	<b>DE</b> Polypropylen <b>EN</b> Polypropylene <b>FR</b> Polypropylène <b>ES</b> Polipropileno <b>HR</b> Polipropilen <b>HU</b> Polipropilén <b>RO</b> Polipropilenă <b>BG</b> Полипропилен
	<b>DE</b> Polypropylen-Kombination <b>EN</b> Polypropylene combination <b>FR</b> Combinaison de polypropylène <b>ES</b> Combinación de polipropileno <b>HR</b> Polipropilenska kombinacija <b>HU</b> Polipropilén kombináció <b>RO</b> Combinație de polipropilenă <b>BG</b> Комбинация от полипропилен
	<b>DE</b> Polyurethan <b>EN</b> Polyurethane <b>FR</b> Polyuréthane <b>ES</b> Poliuretano <b>HR</b> Poliuretán <b>HU</b> Poliuretán <b>RO</b> Poliuretán <b>BG</b> Полиуретан
	<b>DE</b> Polyvinylchlorid <b>EN</b> Polyvinyl chloride <b>FR</b> Chlorure de polyvinyle <b>ES</b> Cloruro de polivinilo <b>HR</b> PVC <b>HU</b> Polivinil-klorid <b>RO</b> Policlorură de vinil <b>BG</b> Поливинил хлорид
	<b>DE</b> Technischer EVA-Schaum <b>EN</b> Technical foam EVA <b>FR</b> Mousse technique EVA <b>ES</b> Espuma técnica EVA <b>HR</b> Tehnička pjena EVA <b>HU</b> EVA műszaki hab <b>RO</b> Spumă tehnică EVA <b>BG</b> Техническа вложка EVA
	<b>DE</b> Polychlorierte und Polypropylen-Röhrchen <b>EN</b> Polychloride and polypropylene pipes <b>FR</b> Tubes EN polychlorure et polypropylène <b>ES</b> Tubos policlorurados y de polipropileno <b>HR</b> Polivinilkloridne i polipropilenske cijevi <b>HU</b> Polivinil-klorid és polipropilén csövek <b>RO</b> Jevi policlorurate și din polipropilenă <b>BG</b> Полихлоридни и полипропиленови тръби
	<b>DE</b> Cu-Al-Rohre <b>EN</b> Cu-Al pipes <b>FR</b> Tubes Cu-Al <b>ES</b> Tubos de Cu-Al <b>HR</b> Cu-Al cijevi <b>HU</b> Cu-Al csövek <b>RO</b> Jevi Cu-Al <b>BG</b> Cu-Al тръби

	<b>DE</b> PP-Rohre <b>EN</b> PP pipes <b>FR</b> Tubes <b>EN</b> PP <b>ES</b> Tubos PP <b>HR</b> PP cijevi <b>HU</b> PP csövek <b>RO</b> Jevi PP <b>BG</b> PP тръби
	<b>DE</b> PVC-Rohre <b>EN</b> PVC pipes <b>FR</b> Tubes <b>EN</b> PVC <b>ES</b> Tubos de PVC <b>HR</b> PVC cijevi <b>HU</b> PVC csövek <b>RO</b> Jevi PVC <b>BG</b> PVC тръби
	<b>DE</b> Rostfreier Stahl <b>EN</b> stainless steel <b>FR</b> Acier inoxydable <b>ES</b> Acero inoxidable <b>HR</b> Nehradžajući čelik <b>HU</b> Rozsdamentes acél <b>RO</b> Oțel inoxidabil <b>BG</b> Нерждаема стомана
	<b>DE</b> Material rostfreier Stahl <b>EN</b> Material stainless steel <b>FR</b> Matériau : acier inoxydable <b>ES</b> Material acero inoxidable <b>HR</b> Materijal nehradžajući čelik <b>HU</b> Rozsdamentes acél anyag <b>RO</b> Materijal oțel inoxidabil <b>BG</b> Материал нерждаема стомана
	<b>DE</b> ABS-Material <b>EN</b> ABS material <b>FR</b> Matériau ABS <b>ES</b> Material ABS <b>HR</b> Materijal ABS <b>HU</b> ABS anyag <b>RO</b> Material ABS <b>BG</b> ABS материал
	<b>DE</b> EPDM-Material <b>EN</b> EPDM material <b>FR</b> Matériau EPDM <b>ES</b> Material EPDM <b>HR</b> Materijal EPDM <b>HU</b> EPDM anyag <b>RO</b> Material EPDM <b>BG</b> EPDM материал
	<b>DE</b> S2-Material <b>EN</b> S2 material <b>FR</b> Matériau S2 <b>ES</b> Material S2 <b>HR</b> Materijal S2 <b>HU</b> S2 anyag <b>RO</b> Material S2 <b>BG</b> Материал S2
	<b>DE</b> Stahlprofil <b>EN</b> Steel profile <b>FR</b> Profilé <b>EN</b> acier <b>ES</b> Perfil de acero <b>HR</b> Čelični profil <b>HU</b> Acél profil <b>RO</b> Profil de oțel <b>BG</b> Стоманен профил
	<b>DE</b> Stahlschiene <b>EN</b> Steel rail <b>FR</b> Rail <b>EN</b> acier <b>ES</b> Carril de acero <b>HR</b> Čelična šina <b>HU</b> Acél sín <b>RO</b> Șină de oțel <b>BG</b> Стоманена рельса
	<b>DE</b> Schneidmesser aus Edelstahl <b>EN</b> Cutting blade made of stainless steel <b>FR</b> Lame de coupe <b>EN</b> acier inoxydable <b>ES</b> Hoja de corte de acero inoxidable <b>HR</b> Rezne oštrice od nehradžućeg čelika <b>HU</b> Rozsdamentes acél vágópengő <b>RO</b> Lamă de tăiere din oțel inoxidabil <b>BG</b> Режешо острие от нерждаема стомана
	<b>DE</b> Einnetmuttern aus Stahl und Edelstahl <b>EN</b> Steel and stainless steel rivet nuts <b>FR</b> Ecrous à rivets <b>EN</b> acier et <b>EN</b> acier inoxydable <b>ES</b> Tuercas remachables de acero y acero inoxidable <b>HR</b> Zakrivne matice od nehradžućeg čelika <b>HU</b> Acél és rozsdamentes acél szegescsanyák <b>RO</b> Piuște nituite din oțel și oțel inoxidabil <b>BG</b> Стоманени и нерждаеми гайки с нитове
	<b>DE</b> Metall <b>EN</b> Metal <b>FR</b> Métal <b>ES</b> Metal <b>HR</b> Metal <b>HU</b> Fém <b>RO</b> Metal <b>BG</b> Метал
	<b>DE</b> Metallverschluss <b>EN</b> Metal closure <b>FR</b> Fermeture <b>EN</b> métal <b>ES</b> Cierre metálico <b>HR</b> Metalna zaklopka <b>HU</b> Fém zár <b>RO</b> Inchidere metalică <b>BG</b> Метално затваряне
	<b>DE</b> Hartmetallklingen <b>EN</b> Carbide blades <b>FR</b> Lames <b>EN</b> carbure cémente <b>ES</b> Cuchillas de carburo <b>HR</b> Oštrice od sinteriranog karbida <b>HU</b> Szinterezett karbid pengék <b>RO</b> Lame de carbură <b>BG</b> Карбидни остриета
	<b>DE</b> Teflon-Beschichtung <b>EN</b> Teflon shell <b>FR</b> Revêtement <b>EN</b> téflon <b>ES</b> Revestimiento de teflón <b>HR</b> Teflonska prevlaka <b>HU</b> Teflon bevonat <b>RO</b> Înveliș de teflon <b>BG</b> Флуороново покритие
	<b>DE</b> Keramik-Fliesen <b>EN</b> Ceramic tiles <b>FR</b> Plaques <b>EN</b> céramique <b>ES</b> Baldosas de cerámica <b>HR</b> Keramičke pločice <b>HU</b> Kerámia lapok <b>RO</b> Plăci ceramice <b>BG</b> Керамични плочки
	<b>DE</b> Titan-Beschichtung <b>EN</b> Titanium shell <b>FR</b> Revêtement <b>EN</b> titane <b>ES</b> Revestimiento de titanio <b>HR</b> Titanijum prevlaka <b>HU</b> Titán bevonat <b>RO</b> Înveliș de titan <b>BG</b> Титаново покритие
	<b>DE</b> Thermoplastischer Kautschuk <b>EN</b> Thermoplastic rubber <b>FR</b> Caoutchouc thermoplastique <b>ES</b> Caucho termoplástico <b>HR</b> Termoplastični kaučuk <b>HU</b> Hőre lágyuló kaucsuk <b>RO</b> Cauciuc termoplastic <b>BG</b> Термопластична гума
	<b>DE</b> Thermoplastische Elastomere <b>EN</b> Thermoplastic elastomers <b>FR</b> Elastomères thermoplastiques <b>ES</b> Elastómeros termoplásticos <b>HR</b> Termoplastični elastomeri <b>HU</b> Hőre lágyuló elasztomerek <b>RO</b> Elastomeri termoplastici <b>BG</b> Термопластични еластомери
	<b>DE</b> Holz, Kunststoff, Aluminium <b>EN</b> Wood, plastic, aluminium <b>FR</b> Bois, plastique, aluminium <b>ES</b> Madera, plástico, aluminio <b>HR</b> Drvo, plastika, aluminij <b>HU</b> Fa, műanyag, alumínium <b>RO</b> Lemn, plastic, aluminiu <b>BG</b> Дърво, пластмаса, алуминий

	<b>DE</b> Wolframcarbide <b>EN</b> Tungsten carbide <b>FR</b> Carbure de tungstène <b>ES</b> Carburo de tungsteno <b>HR</b> Volframov karbid <b>HU</b> Volfrám-karbid <b>RO</b> Carbură de tungsten <b>BG</b> Волфрамов карбид
	<b>DE</b> Zink <b>EN</b> Zinc <b>FR</b> Zinc <b>ES</b> Zinc <b>HR</b> Cink <b>HU</b> Cink <b>RO</b> Zinc <b>BG</b> Цинк
	<b>DE</b> Griff aus Holz <b>EN</b> Wooden handle <b>FR</b> Manche <b>EN</b> bois <b>ES</b> Mango de madera <b>HR</b> Drvena ručka <b>HU</b> Fa fogantyú <b>RO</b> Mâner din lemn <b>BG</b> Дървена дръжка
	<b>DE</b> Glasmessgriff aus Holz <b>EN</b> Wooden handle of a glass cutter <b>FR</b> Manche de coupe-verre <b>EN</b> bois <b>ES</b> Mango de madera para cortadores de vidrio <b>HR</b> Drvena ručka noža za staklo <b>HU</b> Fa üvegágó kés nyél <b>RO</b> Mâner din lemn pentru cuțit de tăiat sticlă <b>BG</b> Дървена дръжка за стъкло
	<b>DE</b> Griff aus Hickoryholz <b>EN</b> Hickory wood handle <b>FR</b> Manche <b>EN</b> bois de hickory <b>ES</b> Mango de madera de nogal americano <b>HR</b> Ručka od hikorijevog drva <b>HU</b> Hickory fanyél <b>RO</b> Mâner din lemn de nuc american <b>BG</b> Дръжка от дърво от хикори
	<b>DE</b> Griff aus Fiberglas <b>EN</b> Fiberglass handle <b>FR</b> Manche <b>EN</b> fibre de verre <b>ES</b> Mango de fibra de vidrio <b>HR</b> Ručka od staklene vlakna <b>HU</b> Üvegszálás nyél <b>RO</b> Mâner din fibră de sticlă <b>BG</b> Дръжка от фибростъкло
	<b>DE</b> Holz <b>EN</b> Wood <b>FR</b> Bois <b>ES</b> Madera <b>HR</b> Drvo <b>HU</b> Fa <b>RO</b> Lemn <b>BG</b> Дърво
	<b>DE</b> Hartholz <b>EN</b> Hard wood <b>FR</b> Bois dur <b>ES</b> Madera dura <b>HR</b> Tvrd drvo <b>HU</b> Keményfa <b>RO</b> Lemn de esență tare <b>BG</b> Твърдо дърво
	<b>DE</b> Weichholz <b>EN</b> Soft wood <b>FR</b> Résineux <b>ES</b> Madera blanda <b>HR</b> Meko drvo <b>HU</b> Puhafa <b>RO</b> Lemn de esență moale <b>BG</b> Меко дърво
	<b>DE</b> Laminat <b>EN</b> Laminat <b>FR</b> Stratifié <b>ES</b> Laminado <b>HR</b> Laminat <b>HU</b> Laminátum <b>RO</b> Laminat <b>BG</b> Ламиниран паркет
	<b>DE</b> Sperrholz <b>EN</b> Plywood <b>FR</b> Contreplaqué <b>ES</b> Madera contrachapada <b>HR</b> Šperploča <b>HU</b> Rétegelt lemez <b>RO</b> Placă <b>BG</b> Шперплат
	<b>DE</b> Holz mit Nägeln <b>EN</b> Wood with nails <b>FR</b> Bois avec clous <b>ES</b> Madera con clavos <b>HR</b> Drvo s čavlima <b>HU</b> Szögelt fa <b>RO</b> Lemn cu cuișe <b>BG</b> Дърво с пирони
	<b>DE</b> MDF-Platte <b>EN</b> MDF <b>FR</b> Panneau <b>ES</b> MDF <b>HR</b> MDF ploča <b>HU</b> MDF lap <b>RO</b> Placă MDF <b>BG</b> MDF
	<b>DE</b> Spanplatte <b>EN</b> Particle board <b>FR</b> Panneau d'aggloméré <b>ES</b> Tablero de partículas <b>HR</b> Iverica <b>HU</b> Forgácslemez <b>RO</b> Placă PAL <b>BG</b> ПДЧ пясъчник
	<b>DE</b> Tischplatte <b>EN</b> Worktops <b>FR</b> Plateau de table <b>ES</b> Tablero de la mesa <b>HR</b> Radna ploča <b>HU</b> Asztallap <b>RO</b> Blat de masă <b>BG</b> Работен плот
	<b>DE</b> Holzschneiden <b>EN</b> Wood cutting <b>FR</b> Coupe du bois <b>ES</b> Corte de madera <b>HR</b> Rezanje drva <b>HU</b> Fa vágás <b>RO</b> Taierea lemnului <b>BG</b> Рязане на дърво
	<b>DE</b> Metallschneiden <b>EN</b> Metal cutting <b>FR</b> Coupe du métal <b>ES</b> Corte de metales <b>HR</b> Rezanje metala <b>HU</b> Fém vágás <b>RO</b> Taierea metalelor <b>BG</b> Рязане на метал
	<b>DE</b> Schneiden von Holz und Metall <b>EN</b> Wood and metal cutting <b>FR</b> Coupe du bois et du métal <b>ES</b> Corte de madera y metal <b>HR</b> Rezanje drva i metala <b>HU</b> Fa, és fém vágás <b>RO</b> Taierea lemnului și a metalului <b>BG</b> Рязане на дърво и метал
	<b>DE</b> Metall und Inox <b>EN</b> Metal and inox <b>FR</b> Métal et inox <b>ES</b> Metal e inox <b>HR</b> Metal i inox <b>HU</b> Fém és inox <b>RO</b> Metal și inox <b>BG</b> Метал и инокс
	<b>DE</b> Aluminium-Kopf <b>EN</b> Aluminum head <b>FR</b> Tête <b>EN</b> aluminium <b>ES</b> Cabezal de aluminio <b>HR</b> Aluminijska glava <b>HU</b> Alumínium fej <b>RO</b> Cap din aluminiu <b>BG</b> Алюминиева глава
	<b>DE</b> Kopf aus Zinkdruckguss <b>EN</b> Die-cast zinc head <b>FR</b> Tête <b>EN</b> zinc moulé <b>ES</b> Cabeza de fundición de zinc <b>HR</b> Glava od cinkovog ođjevka <b>HU</b> Öntött cink fej <b>RO</b> Cap din zinc turnat <b>BG</b> Цинкова глава, отлита от цинк

	<b>DE</b> Schutzklasse III (bei Beleuchtung) <b>EN</b> Protection class III (in lighting) <b>FR</b> Classe de protection III (en éclairage) <b>ES</b> III Clase de protección (en iluminación) <b>HR</b> III Klasa zaštite (za rasvjetu) <b>HU</b> III. védelmi osztály (világítás) <b>RO</b> Clasa de protecție III (în iluminat) <b>BG</b> Клас на защита III (осветление)
	<b>DE</b> Schutzklasse II (bei Beleuchtung) <b>EN</b> Protection class II (in lighting) <b>FR</b> Classe de protection II (en éclairage) <b>ES</b> II Clase de protección (en iluminación) <b>HR</b> II Klasa zaštite (za rasvjetu) <b>HU</b> II. védelmi osztály (világítás) <b>RO</b> Clasa de protecție II (în iluminat) <b>BG</b> Клас на защита II (осветление)
	<b>DE</b> III. Messgenauigkeitsklasse <b>EN</b> III Measurement accuracy class <b>FR</b> Classe de précision de mesure III <b>ES</b> III Clase de precisión de la medición <b>HR</b> III Klasa točnosti mjerenja <b>HU</b> III. Méré-si pontossági osztály <b>RO</b> Clasa de precizie a măsurătorilor III <b>BG</b> III Клас на точност на измерване
	<b>DE</b> II. Genauigkeitsklasse <b>EN</b> II Accuracy class <b>FR</b> Classe de précision II <b>ES</b> II Clase de precisión <b>HR</b> II klasa točnosti <b>HU</b> II. pontossági osztály <b>RO</b> Clasa de precizie II <b>BG</b> Клас на точност II
	<b>DE</b> Zertifikat für sicheres Arbeiten unter Spannung <b>EN</b> Safety certificate for working under voltage <b>FR</b> Certificat de sécurité pour le travail sous tension <b>ES</b> Certificado de seguridad para trabajar bajo tensión <b>HR</b> Sigurnosni certifikat za rad pod naponom <b>HU</b> Feszültség alatt történő munkavégzési biztonsági bizonyítvány <b>RO</b> Certificat pentru lucrul în condiții de siguranță în timpul lucrului sub tensiune <b>BG</b> Сертификат за безопасност при работа под напрежение
	<b>DE</b> Das Produkt entspricht der jeweiligen Norm der Zertifizierungsstelle des DIN Deutsches Institut für Normung <b>EN</b> The product meets the relevant standard of the DIN Deutsches Institut für Normung certification body <b>FR</b> Le produit est conforme à la norme correspondante de l'organisme de certification DIN Deutsches Institut für Normung <b>ES</b> El producto cumple la norma correspondiente del organismo de certificación DIN Deutsches Institut für Normung <b>HR</b> Proizvod ispunjava zadane standarde certifikacijskog tijela DIN Deutsches Institut für Normung <b>HU</b> A termék megfelel a DIN Deutsches Institut für Normung tanúsító szervezet vonatkozó szabványának <b>RO</b> Produsul îndeplinește standardul respectiv al organismului de certificare DIN Deutsches Institut für Normung <b>BG</b> Продуктът отговаря на съответния стандарт на сертификационния орган на DIN Deutsches Institut für Normung
	<b>DE</b> Schaft nach DIN 1041 gefertigt <b>EN</b> Head is made in accordance with 7239 DIN <b>FR</b> Tête conforme à la norme 1041 DIN <b>ES</b> Mango fabricado según la norma 1041 DIN <b>HR</b> Glava je izrađena u skladu sa standardom 1041 DIN <b>HU</b> A fej a DIN 1041 norma szerint készült <b>RO</b> Cap realizat în conformitate cu standardul 1041 DIN <b>BG</b> Форма е изработена в съответствие с DIN 1041
	<b>DE</b> Das Produkt entspricht der einschlägigen europäischen Norm <b>EN</b> The product meets the European standard <b>FR</b> Le produit est conforme à la norme européenne correspondante <b>ES</b> Producto cumple con la norma europea correspondiente <b>HR</b> Proizvod zadovoljava zadani europski standard <b>HU</b> A termék megfelel a vonatkozó európai szabványnak <b>RO</b> Produsul este conform cu standardul european relevant <b>BG</b> Продуктът отговаря на дадения европейски стандарт
	<b>DE</b> Qualitätszeichen vom TÜV Rheinland verliehen <b>EN</b> Quality mark awarded by TÜV Rheinland <b>FR</b> Label de qualité décerné par TÜV Rheinland <b>ES</b> Marca de calidad concedida por TÜV Rheinland <b>HR</b> Označka kvalitete dodijeljena od strane TÜV Rheinland <b>HU</b> A TÜV Rheinland által kiállított minőségi védjegy <b>RO</b> Semnul de calitate acordat de TÜV Rheinland <b>BG</b> Знак за качество, присъден от TÜV Rheinland
	<b>DE</b> Härtegrad des Stahls nach der Rockwell-Skala <b>EN</b> The level of hardness of steel according to the Rockwell scale <b>FR</b> Niveau de dureté de l'acier selon l'échelle de Rockwell <b>ES</b> Nivel de dureza del acero según la escala Rockwell <b>HR</b> Razina tvrdoće čelika po Rockwellu <b>HU</b> Az acél Rockwell-skála szerinti keménységi szintje <b>RO</b> Nivelul de duritate al oțelului conform scalei Rockwell <b>BG</b> Нивото на твърдост на стоманата по скалата на Рокуел
	<b>DE</b> Härtegrad der Klängen nach der Rockwell-Skala <b>EN</b> The level of hardness of the blades according to the Rockwell scale <b>FR</b> Niveau de dureté des lames selon l'échelle de Rockwell <b>ES</b> Nivel de dureza del cuchillas según la escala Rockwell <b>HR</b> Razina tvrdoće oštrica po Rockwellu <b>HU</b> A pengék Rockwell-skála szerinti keménységi szintje <b>RO</b> Nivelul de duritate al lamelor în conformitate cu scara Rockwell <b>BG</b> Нивото на твърдост на остриетата според скалата на Рокуел
	<b>DE</b> Härtebereich des Stahls nach der Rockwell-Skala <b>EN</b> The range of steel hardness according to the Rockwell scale <b>FR</b> Gamme de dureté de l'acier selon l'échelle de Rockwell <b>ES</b> Rango de dureza del acero según la escala Rockwell <b>HR</b> Raspon tvrdoće čelika po Rockwellu <b>HU</b> Az acél Rockwell-skála szerinti keménységi tartomány <b>RO</b> Gama de duritate a oțelului în conformitate cu scara Rockwell <b>BG</b> Диапазонът на твърдост на стоманата според скалата на Рокуел

	<b>DE</b> Härtebereich der Backen nach der Rockwell-Skala <b>EN</b> Jaw hardness range according to the Rockwell scale <b>FR</b> Gamme de dureté des mâchoires selon l'échelle de Rockwell <b>ES</b> Rango de dureza de la mandíbula según la escala Rockwell <b>HR</b> Raspon tvrdoće čeljusti po Rockwellu <b>HU</b> A pókak Rockwell-skála szerinti keménységi tartomány <b>RO</b> Gama de duritate a făcilor în conformitate cu scara Rockwell <b>BG</b> Диапазон на твърдост на стъги според скалата на Рокуел
	<b>DE</b> Härte der Klänge nach der Rockwell-Skala <b>EN</b> Blade hardness according to the Rockwell scale <b>FR</b> Dureté de la lame selon l'échelle de Rockwell <b>ES</b> Dureza de hoja según la escala Rockwell <b>HR</b> Raspon tvrdoće oštrice po Rockwellu <b>HU</b> A penge Rockwell-skála szerinti keménysége <b>RO</b> Duritatea lamei în conformitate cu scara Rockwell <b>BG</b> Твърдост на острието по скалата на Рокуел
	<b>DE</b> Härte des Kabels nach der Rockwell-Skala <b>EN</b> Cable hardness according to Rockwell scale <b>FR</b> Dureté du câble selon l'échelle de Rockwell <b>ES</b> Dureza del cable según la escala Rockwell <b>HR</b> Tvrdoća kabla po Rockwellu <b>HU</b> A kábel Rockwell-skála szerinti keménysége <b>RO</b> Duritatea cablului în conformitate cu scara Rockwell <b>BG</b> Твърдост на кабела по скалата на Рокуел
	<b>DE</b> Härtebereich des Sägebblatts nach der Rockwell-Skala <b>EN</b> Saw blade hardness range according to the Rockwell scale <b>FR</b> Gamme de dureté de la lame selon l'échelle de Rockwell <b>ES</b> Rango de dureza de la cuchillas según la escala Rockwell <b>HR</b> Raspon tvrdoće lista po Rockwellu <b>HU</b> A rascni Rockwell-skála szerinti keménységi tartomány <b>RO</b> Gama de duritate a lamei în conformitate cu scara Rockwell <b>BG</b> Диапазон на твърдост на острието по скалата на Рокуел
	<b>DE</b> Härtebereich des Sägebblatts nach der Rockwell-Skala <b>EN</b> Saw blade hardness range according to the Rockwell scale <b>FR</b> Gamme de dureté de la lame selon l'échelle de Rockwell <b>ES</b> Rango de dureza de la cuchillas según la escala Rockwell <b>HR</b> Raspon tvrdoće lista po Rockwellu <b>HU</b> A rascni Rockwell-skála szerinti keménységi tartomány <b>RO</b> Gama de duritate a lamei în conformitate cu scara Rockwell <b>BG</b> Диапазон на твърдост на острието по скалата на Рокуел

**DE** Mehrzweck-Präzisionszange **EN** Precision universal pliers **FR** Pince de précision multi-usages **ES** Alicates multiusos de precisión **HR** Univerzalna precizna špic kliješta **HU** Univerzális precíziós fogók **RO** Clește de precizie multifuncțional **BG** Прецизни универсални клещи

**DE** Präzisionszange verlängert **EN** Precision pliers elongated **FR** Pince de précision allongée **ES** Alicates de precisión, alargados **HR** Produžena precizna špic kliješta **HU** Precíziós hosszúsúró fogók **RO** Clește de precizie alungit **BG** Прецизни клещи удължени

**DE** Vordere Präzisionszange **EN** Precision nose pliers **FR** Pince de précision avant **ES** Alicates de precisión frontales **HR** Precizna čeona špic kliješta **HU** Precíziós homlokcsipőfogók **RO** Clește de precizie frontal **BG** Прецизни клещи за нос

**DE** Gerändete Klinge **EN** Knurled bit **FR** Embout moleté **ES** Hoja moleteada **HR** Bit s brazdoma **HU** Recézett csavarhúzó-bit **RO** Vârf zimțat **BG** Набрэдден връх

**DE** Gerader Schnitt **EN** Straight cutting **FR** Coupe droite **ES** Corte recto **HR** Ravni rez **HU** Egyenes vágás **RO** Tăietură dreaptă **BG** Права кройка

**DE** Mit Daumen halten **EN** Hold with your thumb **FR** Tenir avec le pouce **ES** Mantener pulsado el pulgar **HR** Pridržati palcom **HU** Tartsa a hüvelykujjával **RO** Țineți cu degetul mare **BG** Дръжте го с палец

**DE** Säge mit auswechselbarem Blatt **EN** Saw with replaceable saw blade **FR** Scie avec lame amovible **ES** Sierra con hoja intercambiable **HR** Pila sa izmjenjivim listom **HU** Fűrész cserélhető fűrészappal **RO** Fierăștrău cu pânză interschimbabilă **BG** Трион със сменяем листо

**DE** Beidseitig geschliffene Klinge **EN** Double-sided sharpened blade **FR** Lame à double tranchant **ES** Cuchilla afilada de doble cara **HR** Oštrica s dvostranim oštrenjem **HU** Kétoldalt élezett penge **RO** Lamă ascuțită pe două fețe **BG** Двойно заточено острие

**DE** Dreiseitig geschliffene Klinge **EN** Three-sided sharpened blade **FR** Lame à triple tranchant **ES** Cuchilla afilada por tres lados **HR** Oštrica s trostranim oštrenjem **HU** Háromoldalt élezett penge **RO** Lamă ascuțită pe trei fețe **BG** Тристранно заточено острие

**DE** Spitze auf drei Knauflenden **EN** Bit on the three ends of the knob **FR** Embout sur trois extrémités du bouton **ES** Cuchilla EN tres extremos del pomo **HR** Bit na tri kraja gumba **HU** Csavarhúzó vég a nyél három végén **RO** Vârf pe trei capete de buton **BG** Накрайник на трите края на качето

**DE** Ratschenmechanismus mit 52 Zähnen **EN** Ratchet mechanism with 52 teeth **FR** Mécanisme à cliquet avec 52 dents **ES** Carraca de 52 dientes **HR** Okidni mehazam čegrtaljke s 52 zuba **HU** 52 fogas racsnis mechanizmus **RO** Mecanism cu clichet cu 52 de dinti **BG** Механизъм на тресчотка с 52 зъба

**DE** Ratschenmechanismus mit 60 Zähnen **EN** Ratchet mechanism with 60 teeth **FR** Mécanisme à cliquet avec 60 dents **ES** Carraca de 60 dientes **HR** Okidni mehazam čegrtaljke s 60 zuba **HU** 60 fogas racsnis mechanizmus **RO** Mecanism cu clichet cu 60 de dinti **BG** Механизъм на тресчотка с 60 зъба

**DE** Ratschenmechanismus mit 72 Zähnen **EN** Ratchet mechanism with 72 teeth **FR** Mécanisme à cliquet avec 72 dents **ES** Carraca de 72 dientes **HR** Okidni mehazam čegrtaljke s 72 zuba **HU** 72 fogas racsnis mechanizmus **RO** Mecanism cu clichet cu 72 de dinti **BG** Храпови механизъм със 72 зъба

**DE** Ratsche mit durchgehendem Kopf **EN** Pass-through ratchet **FR** Cliquet traversant **ES** Carraca recta **HR** Okasta čegrtaljka **HU** Átengedős racsni **RO** Clichet de trecere **BG** Проходно тресчотка

**DE** Breite Backenabstände **EN** Wide jaw spacing **FR** Large espacement des mâchoires **ES** Gran ancho de mandibula **HR** Široki razmak čeljusti **HU** Széles pofatávolság **RO** Spațiere largă a făciilor **BG** Широко отвор на челюстта

**DE** Breite Backenabstände **EN** Wide jaw spacing **FR** Large espacement des mâchoires **ES** Gran ancho de mandibula **HR** Široki razmak čeljusti **HU** Széles pofatávolság **RO** Spațiere largă a făciilor **BG** Широко отвор на челюстта

**DE** 1/4" Schnellverschlusskupplung **EN** 1/4" quick coupler **FR** Raccord rapide 1/4" **ES** 1/4" acoplamiento rápido **HR** Brza spojnica 1/4" **HU** 1/4" gyorscsatlakozó **RO** cuplaj rapid 1/4" **BG** 1/4" бърз съединител

**DE** Länge der Düse **EN** Nozzle length **FR** Longueur de la buse **ES** Longitud de la boquilla **HR** Dužina mlaznice **HU** Fúvóka hosszúság **RO** Lungimea duzei **BG** Дължина на дюзата

**DE** Länge der Druckleitung **EN** Length of the pressure hose **FR** Longueur du tuyau de pression **ES** Longitud de la línea de presión **HR** Dužina tlačnog voda **HU** A nyomástovábbító cső hossza **RO** Lungimea conductei de presiune **BG** Дължина на маркуча за налягане

**DE** Innendurchmesser und Außendurchmesser **EN** Inner diameter and outer diameter **FR** Diamètre intérieur et diamètre extérieur **ES** Diámetro interior y exterior **HR** Unutarnji promjer i vanjski promjer **HU** Belső átmérő és külső átmérő **RO** Diametru interior și diametrul exterior **BG** Вътрешен и външен диаметър

**DE** 40000 Betriebsstunden **EN** 40,000 working hours **FR** 40000 heures de fonctionnement **ES** 40000 horas de funcionamiento **HR** 40000 sati rada **HU** 40000 munkaaóra **RO** 40000 ore de funcționare **BG** 40 000 работни часа

**DE** Bis zu 200000 Ein- und Ausschaltvorgänge **EN** Up to 200,000 on and off switches **FR** Jusqu'à 200 000 marche/arrêt **ES** Hasta 200 000 encendidos/apagados **HR** Do 200000 uključivanja i isključivanja **HU** Akár 200000 be/ki kapcsolás **RO** Până la 200000 de porniri/opriiri **BG** Do 200 000 вкључения и изкључения

**DE** Energieklasse **EN** Type of energy class **FR** Type de classe énergétique **ES** Tipo de clase energética **HR** Vrsta energetskego razreda **HU** Energiaosztály típus **RO** Tipul clasei energetice **BG** Тип енергийн клас

**DE** Ohne Batterie **EN** Without battery **FR** Sans pile **ES** Sin pilas **HR** Bez baterija **HU** Elem nélkül **RO** Fără baterii **BG** Без батерии

**DE** Eine AA-Batterie **EN** One AA battery **FR** Une pile AA **ES** Una pila AA **HR** Jedna baterija AA **HU** Egy AA elem **RO** O baterie AA **BG** Една батерия тип AA

**DE** Messgenauigkeit **EN** Accuracy of measurement **FR** Précision de la mesure **ES** Precisión de las mediciones **HR** Točnost mjerenja **HU** Mérés pontosság **RO** Precizia măsurătorilor **BG** Точност на измерване

**DE** Schiebeknopf **EN** Sliding knob **FR** Bouton coulissant **ES** Pomo deslizable **HR** Klizna poluga **HU** Eltolható gomb **RO** Buton glisant **BG** Плъзгащо се копче

**DE** Einstellung der Schnitttiefe **EN** Cutting depth adjustment **FR** Réglage de la profondeur de l'encoche **ES** Ajuste de la profundidad de la muesca **HR** Regulacija dubine ureza **HU** A vágási mélység beállítása **RO** Reglarea adâncimii creșterurii **BG** Регулиране на дълбочината на прореза

**DE** Stoßdämpfende Endkappen **EN** Shakes absorbing covers **FR** Embouts absorbant les chocs **ES** Tapas de extremo con absorción de impactos **HR** Zaštitne kapice na krajevima za apsorpciju udaraca **HU** Ütésállapító végzáró sapkák **RO** Capace de capăt cu amortizare a șocurilor **BG** Крайни корпусу за амортизация

**DE** Automatischer Klingenrückzug **EN** Function of automatic blade retraction **FR** Fonction de rétraction automatique de la lame **ES** Función de retracción automática de la hoja **HR** Funkcija automatskog uvlačenja oštrice **HU** Automatikus penge visszahúzási funkció **RO** Funcția de retragere automată a lamei **BG** Автоматична функция за прибиране на острие

**DE** Sicherheitsgurtschnürer-Funktion **EN** Function of safety seat belt cutting **FR** Fonction de coupe de ceinture de sécurité **ES** Función de corte del cinturón de seguridad **HR** Funkcija rezanja sigurnosnog pojasa **HU** Biztonsági övágó funkció **RO** Funcția de tăiere a centurii de siguranță **BG** Функция за рязане на ленти за безопасност

**DE** Funktion der Klingenauswurfsperre **EN** Function of blocking blade sliding out **FR** Fonction de verrouillage de l'éjection de la lame **ES** Función de bloqueo de expulsión de la hoja **HR** Funkcija blokade izvlačenja oštrice **HU** Pengekitolás blokkoló funkció **RO** Funcția de blocare a eiecției lamei **BG** Блокиране на изваждане на острие

**DE** Klingenauswurf-Sperrfunktion mit Klingenlängeinstellung **EN** Function of blocking blade sliding out with adjustable blade length **FR** Fonction de verrouillage de l'éjection de la lame avec réglage de sa longueur **ES** Función de bloqueo de la hoja con ajuste de la longitud de la hoja **HR** Funkcija blokade izvlačenja oštrice s regulacijom mjeline dužine **HU** Pengekitolás blokkoló funkció pengehossz beállítással **RO** Funcția de blocare a eiecției lamei cu reglarea lungimii lamei **BG** Блокиране на изваждане на острие с регулация на дължина

**DE** Klebepatrone schwarz **EN** Black glue cartridge **FR** Cartouche de colle noire **ES** Cartucho de pegamento negro **HR** Patrona s ljeplom crne boje **HU** Fekete ragasztópisztoly betét **RO** Rezervă de lipici negru **BG** Вложка лепило черно

**DE** Profilierter 4x90° Bohrkopf **EN** 4x90° profiled drill head **FR** Tête de forage profilée 4x90° **ES** Perfil 4x90° cabeza de perforación **HR** Profilirana glava svrdla 4x90° **HU** Profilozott 4x90° fúrófej **RO** Cap de burghiu profilat 4x90° **BG** 4x90° профилирано средло

**DE** Zusätzliche Spiralen an der Kante der Bohrkronen **EN** Additional spirals at the edge of the drill **FR** Spirales supplémentaires sur le bord du foret **ES** Espirales adicionales en el borde de la broca **HR** Dodatne spirale na rubu svrdla **HU** Kiegészítő spirálak a fúrószár szélén **RO** Spirale suplimentare pe marginea burghiuului **BG** Допълнителни спирали по ръба на средлото

**DE** Klemmen vom Typ Clic und Clic-R **EN** Clic and Clic-R clamps **FR** Bornes de type Clic et Clic-R **ES** Terminales de tipo Clic y Clic-R **HR** Stezaljke tip Clic i Clic-R **HU** Clic és Clic-R típusú terminálök **RO** terminale de tip Clic și Clic-R **BG** Щипци Clic i Clic-R

**DE** Durchgehende Diamantscheibe **EN** Continuous diamond wheel blade **FR** Disque diamanté continu **ES** Disco diamantado continuo **HR** Dijamantni disk za kontinuirani rad **HU** folyamatos gyémánttárcsa **RO** Disc diamantat continu **BG** Диамантен диск постоянен

**DE** LED-Beleuchtung in der Magnetspitze **EN** LED lighting mounted in the magnetic tip **FR** Eclairage LED incorporé dans la pointe magnétique **ES** Iluminación LED incorporada **EN** el extremo magnético **HR** LED rasvjeta ugrađena u magnetni nastavak **HU** LED világítás a mágneses hegybe integrálva **RO** iluminat cu LED-uri incorporat în capătul magnetic **BG** LED осветление, монтирано в магнитния връх

**DE** Großes und übersichtliches Display **EN** Large and clear display **FR** Affichage large et clair **ES** Pantalla grande y clara **HR** Veliki i pregledni zaslon **HU** Nagy és jól olvasható kijelző **RO** Afişaj mare și clar **BG** Голям и ясен дисплей

**DE** Aufzeichnung der letzten 20 Messungen **EN** Records last 20 measurements **FR** Enregistrement des 20 dernières mesures **ES** Registro de las últimas 20 mediciones **HR** Snimanje 20 posljednjih mjerenja **HU** Az utolsó 20 mérés rögzítése **RO** Înregistrarea ultimelor 20 de măsurători **BG** Записва последните 20 измервания

**DE** Anzahl der Betriebssysteme **EN** Quantity of operating systems **FR** Nombre de systèmes d'exploitation **ES** Número de sistemas operativos **HR** Broj operativnih sustava **HU** Az operációs rendszerek száma **RO** Numărul de sisteme de operare **BG** Брой операционни системи

**DE** Messung mit dem Entfernungsmesser **EN** Rangefinder measurement **FR** Mesure du télémètre **ES** Medición con telémetro **HR** Mjerenje daljinometrom **HU** A távolságmérő mérése **RO** Măsurarea telemetrului **BG** Измерване на далекомер

**DE** Absisolierzange mit Schneider **EN** Wire stripper with cutter **FR** Pince à dénuder avec coupe-fil **ES** Alicates de pelar con cortador **HR** Špic kliješta za skidanje izolacije s rezačem **HU** Kábelcsúszasztó csipőfogó vágóval **RO** Clește de deizolat fire cu tăietor **BG** Клещи за свалчане на изолация с нож

**DE** Stahldrahtabsolierzange mit Schneider **EN** Wire stripper with steel cutter **FR** Pince à dénuder avec coupe-fil **ES** acier **ES** Alicates para pelar con cortador de tubos de acero **HR** Špic kliješta za skidanje izolacije s čeličnim rezačem **HU** Kábelcsúszasztó csipőfogó acél vágóval **RO** Clește de deizolat sârmă cu tăietor de oțel **BG** Клещи за свалчане на изолация с нож от стомана

**DE** Absolierzange mit Schneider **EN** Wire stripper with cutter **FR** Pince à dénuder avec coupe-fil **ES** Alicates de pelar con cortador **HR** Špic kliješta za skidanje izolacije s rezačem **HU** Kábelcsúszasztó csipőfogó vágóval **RO** Clește de deizolat fire cu tăietor **BG** Клещи за свалчане на изолация с нож

**DE** SK5 Stahlschneider **EN** SK5 steel cutter **FR** Coupe-fil **EN** acier SK5 **ES** Cortadora de acero SK5 **HR** Rezač čelični SK5 **HU** SK5 acél vágó **RO** Tăietor de oțel SK5 **BG** Нож от стомана SK5

**DE** Absolierzange mit Schneider **EN** Wire stripper with cutter **FR** Pince à dénuder avec coupe-fil **ES** Alicates de pelar con cortador **HR** Špic kliješta za skidanje izolacije s rezačem **HU** Kábelcsúszasztó csipőfogó vágóval **RO** Clește de deizolat fire cu tăietor **BG** Клещи за свалчане на изолация с нож

**DE** Absolierzange mit Schneider **EN** Wire stripper with cutter **FR** Pince à dénuder avec coupe-fil **ES** Alicates de pelar con cortador **HR** Špic kliješta za skidanje izolacije s rezačem **HU** Kábelcsúszasztó csipőfogó vágóval **RO** Clește de deizolat fire cu tăietor **BG** Клещи за свалчане на изолация с нож

**DE** Kerbe in der Schere zum einfachen Schneiden von Kabeln **EN** Eension in the scissors to facilitate cutting the wires **FR** Encoche dans les ciseaux pour faciliter la coupe des câbles **ES** Muesca **EN** la cizalla para facilitar el corte de los cables **HR** Iznaz u škarama za lakše rezanje vodova **HU** Bevágás az olóperengékben a kábeleknél könnyebb átvágásához **RO** Crestătură în foarfecă pentru tăierea ușoară a cablurilor **BG**

**DE** LED Chip On Board Technologie, Leistung 3 W **EN** LED Made in Chip On Board technology, power 3 W **FR** LED dans la technologie Chip On Board, puissance 3 W **ES** Tecnología de chip LED On, potencia 3 W **HR** LED u tehnologiji Chip On Board, snaga 3 W **HU** Chip On Board technológiájú LED, 3 W teljesítmény **RO** LED în tehnologia Chip On Board, putere 3 W **BG** LED изработен в технологията Chip on Board, мощ 3W

**DE** Gesenkgeschmiedet **EN** Drop forged **FR** Forgeage à matrice **ES** Forjado **EN** gota **HR** Kovano u uokovju **HU** Alakosan sajtolt **RO** Forjat cu matrice **BG** Кована по матрично

**DE** Presse mit doppeltem Verriegelungsmechanismus **EN** Mass squeezer with double locking mechanism **FR** Pistolet de mastic à double mécanisme de verrouillage **ES** Expirimidor de doble acción con bloqueo **HR** Pištolj za istiskivanje mase s dvostrukim mehanizmom blokade **HU** Kinyomópisztoly ketős blokkoló mechanizmussal **RO** Pistol pentru mase cu mecanism de blocare dublu **BG** Пиistolет за смеси с двоен заключващ механизъм

**DE** Langlebige Gelenke **EN** Durable universal joint **FR** Joints durables **ES** Juntas duraderas **HR** Trajni zglobovi **HU** Tartós csuklók **RO** Articulații durabile **BG** Устойчиви стави

**DE** Einfacher Klingenswechsel **EN** Easy blade change **FR** Remplacement facile de la lame **ES** Cambio fácil de las cuchillas **HR** Jednostavno zamjena oštrice **HU** Könnyű pengecserére **RO** Înlocuire ușoară a lamei **BG** Лесна смяна на острието

**DE** Einfaches Crimpen **EN** Easy clamping **FR** Sertissage facile **ES** Fácil de engarzar **HR** Lako zatezanje **HU** Könnyen összenyomható **RO** Sertizare ușoară **BG** Лесно затягане

**DE** Ergonomischer Griff **EN** Ergonomic handle **FR** Manche ergonomique **ES** Asa ergonómica **HR** Ergonomska ručka **HU** Ergonómikus markolat **RO** Mâner ergonomic **BG** Ергономична дръжка

**DE** Ergonomische Verpackung **EN** Ergonomic packaging **FR** Emballage ergonomique **ES** Embalaje ergonómico **HR** Ergonomska ambalaža **HU** Ergonómikus csomagolás **RO** Ambalaj ergonomic **BG** Ергономична опаковка

**DE** Sechskantflansch an der Basis des Griiffs **EN** Hex collar at the handle root **FR** Bride hexagonale à la base de la manche **ES** Brida hexagonal **EN** la base del mango **HR** Šeste-rokutna pirinčnica na spoju ručke **HU** Hatszögletű karima a markolat tövénél **RO** Flanșă hexagonală la baza mânerului **BG** Шестъгълна яка на основата на дръжката

**DE** Elastische Spitze **EN** Flexible bit **FR** Embout flexible **ES** Cuchilla flexible **HR** Elastican vrh **HU** Rugalmas hegy **RO** Vârf flexibil **BG** Гъвкав накрайник

**DE** Für Lichtwellenleiter **EN** For optical fibers **FR** Pour les fibres optiques **ES** Para fibras ópticas **HR** Za optičke kablove **HU** Száloptikához **RO** Pentru fibre optice **BG** За оптични влакна

**DE** Für Dieselfahrzeuge **EN** For cars with diesel engines **FR** Pour les voitures diesel **ES** Para los vehiculos diesel **HR** Za automobila s dizelskim motorima **HU** Dízelüzemű személygépkocsikhoz **RO** Pentru autoturismele diesel **BG** За автомобили с дизелови двигатели

**DE** Für Trommelbremsen **EN** For drum brakes **FR** Pour les freins à tambour **ES** Para frenos de tambor **HR** Za bubanj kočnice **HU** Dobfékkehöz **RO** Pentru frânele cu tambur **BG** За барабани спирачки

**DE** Präzise **EN** Precise **FR** Précision **ES** Preciso **HR** Precizan **HU** Precíz **RO** De precizie **BG** Прецизно

**DE** Rosetten-Kombizange **EN** Rosette pliers connection **FR** Pince avec une connexion à rosette **ES** Alicates de rosetas articuladas **HR** Ojačani spoj kliješta (rozeta) **HU** Rozettás fogó csatlakozás **RO** Clește cu rozetă **BG** Розетна връзка на клещи

**DE** Niederdruck-Spritzpistolen **EN** Low pressure spray guns **FR** Pistoles de peinture à basse pression **ES** Pistolas de baja presión **HR** Niskotlačni pištolj za lakiranje **HU** Alacsony nyomású festőpisztolyok **RO** Pistole de pulverizare de joasă presiune **BG** Пиistolети за лакиране с ниско налягане

**DE** Gürtelclip **EN** Belt hook **FR** Clip de ceinture **ES** Clip para el cinturón **HR** Kočpa za remen **HU** Övcsipes **RO** Clemă pentru curea **BG** Щипка за колан

**DE** Öffnung zum Aufhängen der Säge **EN** Anging hole for the saw **FR** Trou pour suspendre la scie **ES** Agujero para colgar la sierra **HR** Otvor za vješanje pile **HU** Fűrész felakasztó furat **RO** Gaură pentru agățarea fierăștrăului **BG** Отвор за поставяне на триона

**DE** Für innen **FR** Pour l'intérieur **ES** Hacia el interior **HR** Prema unutra **HU** Befelé **RO** Spre interior **BG** Външн

**DE** Jumbo-Schlagwerk **EN** umbo hammer mechanism **FR** Mécanisme à percussion Jumbo **ES** Mecanismo de impacto Jumbo **HR** Udarni mehazim Jumbo **HU** Jumbo ütőmechanizmus **RO** Mecanism de impact Jumbo **BG** Jumbo чукос механизъм

**DE** LED-Technologie **EN** LED technology **FR** Technologie LED **ES** Tecnología LED **HR** Tehnologija LED **HU** LED technológia **RO** Tehnologie LED **BG** LED технология

**DE** LED-Technologie, Leistung 3 W **EN** LED technology, power 3 W **FR** Technologie LED, puissance 3 W **ES** Tecnología LED, potencia 3 W **HR** Tehnologija LED, snaga 3 W **HU** LED technológia, 3 W teljesítmény **RO** Tehnologie LED, putere 3 W **BG** LED технология, мощност 3 W

**DE** Getöntes Glas - Stufe 6 **EN** Tinted glass - level 6 **FR** Vitres teintées - niveau 6 **ES** Cristales tintados - nivel 6 **HR** Zatamnjena stakla - razina 6 **HU** Sötétített üveg - 6. szint **RO** Geamuri fumurii - nivel 6 **BG** Тонирано стъкло - ниво 6

**DE** Licht **EN** Light **FR** Léger **ES** Ligero **HR** Lagane **HU** Könnyű **RO** Ușoare **BG** Лек

**DE** Rückschlagfeder **EN** Rebound spring **FR** Ressort de rebond **ES** Muelle de rebote **HR** Tlačna opruga **HU** Visszatűtő rugó **RO** Arc reflex **BG** Отскочна пружина

**DE** Niedriges Profil **EN** Low profile **FR** Profil bas **ES** Perfil bajo **HR** Niski profil **HU** Alacsony profil **RO** Profil jos **BG** Нисък профил

**DE** 6-facher Gliedermaßstab **EN** 6-segment foldable rule **FR** Mesure pliable à 6 segments **ES** Medida plegable de 6 piezas **HR** Sklopivi meter 6-dijelni **HU** 6 részes összehajtható mérőlé **RO** Riglă pliatibilă 6 segmente **BG** 6-сегментно съваемо правило

**DE** 10-facher Gliedermaßstab **EN** 10-segment foldable rule **FR** Mesure pliable à 10 segments **ES** Medida de plegado de 10 elementos **HR** Sklopivi meter 10-dijelni **HU** 10 részes összehajtható mérőlé **RO** Riglă pliatibilă 10 segmente **BG** Правило за съваене от 10 сегмента

**DE** Stahlende am Griff zum Anschlagen **EN** Steel ending on the handle, used for striking **FR** Extrémité du manche **EN** acier pour frapper **ES** Extremo de acero **EN** el mango para golpear **HR** Čelični vrh ručke za udaranje **HU** A markolat acél vége kalapáccsal üthető **RO** Capăt din oțel al mânerului pentru batere **BG** Строманен край на дръжката, използван за удране

**DE** Lange, schattierte Backen **EN** Long thin jaws **FR** Longues mâchoires rétrécies **ES** Mandibulas largas y finas **HR** Duge čeljusti smanjene debljine **HU** Hosszú, vékonyított pofák **RO** Făci lungi și subțiri **BG** Дълги тънки стави

**DE** Magnethalter mit Innenmagnet **EN** Magnetic holder with an internal magnet **FR** Support magnétique avec aimant intérieur **ES** Soporte magnético con imán interior **HR** Magneta drška s unutarnjim magnetom **HU** Mágneses felszedő belső mágnessel **RO** Suport magnetic cu magnet interior **BG** Магнитен държач с вътрешен магнит

**DE** Magnetische Schraubendreherspitze **EN** Magnetic screwdriver bit **FR** Embout magnétique de tournevis **ES** Hoja

 **DE** Schlaufe zum Aufhängen von Werkzeugen **EN** Loop for hanging tools **FR** Boucle pour suspendre les outils **ES** Bucle para colgar de herramientas **HR** Petljica za vješanje alata **HU** Hurok a szerzőszámok felakasztásához **RO** Bucălă pentru agățarea uneltelor **BG** Примка за окачване на инструменти

 **DE** Spannzange **EN** Collet **FR** Collet de serrage **ES** Collet **HR** Zatezna čahura **HU** Befogópatron **RO** Manson de prindere **BG** Патронник

 **DE** Steckverbinder, isolierte Hülsen **EN** Connector, slip-on sleeves **FR** Connecteur, douilles isolées **ES** Conector, manguitos desizantes **HR** Konektor, izolirane stopice **HU** Csatlakozó, szigetelt kábelvégek **RO** Conector, prize izolate **BG** Съединител, изолирани ръкави

 **DE** Spannzange **EN** Collet **FR** Collet de serrage **ES** Collet **HR** Stezna čahura **HU** Befogópatron **RO** Manson de prindere **BG** Патронник

 **DE** Typ des Kabelendes **EN** Type of cable end **FR** Type d'extrémité de câble **ES** Tipo de terminal de cable **HR** Vrsta kabelaškog završetka **HU** Kábelvég típusa **RO** Tip capăt de cablu **BG** Тип на края на кабела

 **DE** Typ des Kabelendes **EN** Type of cable end **FR** Type d'extrémité de câble **ES** Tipo de terminal de cable **HR** Vrsta kabelaškog završetka **HU** Kábelvég típusa **RO** Tip capăt de cablu **BG** Тип на края на кабела

 **DE** Typ des Kabelendes **EN** Type of cable end **FR** Type d'extrémité de câble **ES** Tipo de terminal de cable **HR** Vrsta kabelaškog završetka **HU** Kábelvég típusa **RO** Tip capăt de cablu **BG** Тип на края на кабела

 **DE** Typ des Kabelendes **EN** Type of cable end **FR** Type d'extrémité de câble **ES** Tipo de terminal de cable **HR** Vrsta kabelaškog završetka **HU** Kábelvég típusa **RO** Tip capăt de cablu **BG** Тип на края на кабела

 **DE** Typ des Kabelendes **EN** Type of cable end **FR** Type d'extrémité de câble **ES** Tipo de terminal de cable **HR** Vrsta kabelaškog završetka **HU** Kábelvég típusa **RO** Tip capăt de cablu **BG** Тип на края на кабела

 **DE** Kabelsteckverbinder **EN** Cable connector **FR** Connecteur de câble **ES** Conector del cable **HR** Kabelovski konektor **HU** Kábelcsatlakozó **RO** Conector de cablu **BG** Кабелен конектор

 **DE** Zylindrischer Steckverbinder **EN** Cylindrical connector **FR** Connecteur cylindrique **ES** Conectores cilíndricos **HR** Cilindrični konektor **HU** Hengeres csatlakozó **RO** Conector cilindric **BG** Цилиндричен конектор

 **DE** Ösensteckverbinder **EN** Ring connector **FR** Connecteur à œil **ES** Conectores de ojal **HR** Konektor okasti **HU** Gyűrűs csatlakozó **RO** Conector cu ochi **BG** Конектор за пръстен

 **DE** Gerader Schnitt **EN** Straight cutting **FR** Coupe droite **ES** Corte recto **HR** Rezanje pravolinijsko **HU** Egyenes vonalú vágás **RO** Taiere dreaptă **BG** Праволінійно різання

 **DE** Gebogener Schnitt **EN** Curvilinear cut **FR** Coupe courbe **ES** Corte curvo **HR** Rezanje krivolinijsko **HU** Íves vonalú vágás **RO** Taiere curbată **BG** Криволинійно изрязване

 **DE** Sauberer gebogener Schnitt **EN** Clear curvilinear cut **FR** Coupe nette et courbe **ES** Corte curvo limpio **HR** Čisto krivolinijsko rezanje **HU** Tiszta íves vonalú vágás **RO** Taiere curbată curată **BG** Чисто криволинійно изрязване

 **DE** Extreme Kurvenschnitte **EN** Cutting on extreme curves **FR** Coupes de courbes extrêmes **ES** Cortes **EN** curvas extremas **HR** Rezanje po ekstremnim lukovima **HU** Extrém íves vágás **RO** Taieri pe curbe extreme **BG** Рязане по екстремни крайни криви

 **DE** Schneller Schnitt **EN** Quick cutting **FR** Coupe rapide **ES** Corte de alta velocidad **HR** Brzo rezanje **HU** Gyors vágás **RO** Taiere rapidă **BG** Бързо рязане

 **DE** Sauberer Schnitt **EN** Clear cutting **FR** Coupe nette **ES** Corte limpio **HR** Čisto rezanje **HU** Tiszta vágás **RO** Taiere curată **BG** Чисто изрязване

 **DE** Sauberer Schnitt beim Trimmen **EN** Clean cut during trimming **FR** Coupe nette lors de la découpe **ES** Corte limpio al recortar **HR** Čisto rezanje kod izrezivanja **HU** Tiszta vágás kivágásnál **RO** Taiere curată la finisare **BG** Чисто рязане при подрязване

 **DE** Milliampere-stunde **EN** Milliampere hour **FR** Milliampère-heure **ES** Milliampereos-hora **HR** Milliampersat **HU** Milliampóróra **RO** Milliampere-ora **BG** Ампер час

 **DE** Breite des Bands **EN** The width of the tape **FR** Largeur du ruban **ES** Ancho de banda **HR** Širina trake **HU** Szalag szélesség **RO** Lățimea benzii **BG** Ширината на лентата

 **DE** Länge der Teleskopverbindung **EN** The length of the telescopic joint steering shaft **FR** Longueur du joint télescopique **ES** Longitud de la junta telescópica **HR** Dužina teleskopskog zgloba **HU** A teleszkópos csukló hossza **RO** Lungimea articulației telescopice **BG** Дължината на телескопичната стъга

 **DE** Länge des Kabels **EN** Cable length **FR** Longueur du câble **ES** Longitud del cable **HR** Dužina voda **HU** Kábel hosszúság **RO** Lungimea cablului **BG** Дължина на кабела

 **DE** Länge des Bands **EN** The length of the tape **FR** Longueur du ruban **ES** Longitud del cinturón **HR** Dužina trake **HU** Szalag hosszúság **RO** Lungimea benzii **BG** Дължината на лентата

 **DE** Beleuchtungsreichweite bis zu 200 m **EN** Lighting range up to 200 m **FR** Capacité d'éclairage jusqu'à 200 m **ES** Alcance de la iluminación hasta 200 m **HR** Domet rasvjeta do 200 m **HU** Világítási tartomány 200 m-ig **RO** Raza de iluminare de până la 200 m **BG** Обхват на осветление до 200 м

 **DE** Maximale Backenöffnung **EN** maximum jaw opening **FR** Ouverture maximale des mâchoires **ES** Apertura máxima de las mandíbulas **HR** Maksimalni razmak čeljusti **HU** Maximális pórfanyitás **RO** Deschiderea maximă a fălcii **BG** Максимум отваряне на стъга

 **DE** Maximale Backenöffnung **EN** maximum jaw opening **FR** Ouverture maximale des mâchoires **ES** Apertura máxima de las mandíbulas **HR** Maksimalni razmak čeljusti **HU** Maximális pórfanyitás **RO** Deschiderea maximă a fălcii **BG** Максимум отваряне на стъга

 **DE** Höhe der trapezförmigen Klinge **EN** The height of the trapezoidal blade **FR** Hauteur de la lame trapezoidale **ES** Altura de la hoja trapezoidal **HR** Visina trapezne oštrice **HU** A trapez penge magassága **RO** Înălțimea lamei trapezoidale **BG** Височината на трапезно острие

 **DE** Größe der trapezförmigen Klinge **EN** Trapezoidal blade size **FR** Taille de la lame trapezoidale **ES** Tamaño de la hoja trapezoidal **HR** Velicina trapezne oštrice **HU** A trapez penge mérete **RO** Dimensiunea lamei trapezoidale **BG** Размер на трапезно острие

 **DE** Minimaler Arbeitsbereich des hydraulischen Wagenhebers **EN** The minimum working range of a hydraulic post jack **FR** Plage de travail minimale du cric hydraulique **ES** Alcance mínimo de trabajo del elevador hidráulico **HR** Minimalni radni raspon hidraulične dizalice **HU** A hidraulikus emelő minimális munkatartománya **RO** Intervalul minim de lucru al ascensorului hidraulic **BG** Минималният работен обхват на хидравличния крик

 **DE** Maximaler Arbeitsbereich des hydraulischen Wagenhebers **EN** Maximum working range of a hydraulic jack post **FR** Plage de travail maximale du cric hydraulique **ES** Alcance máximo de funcionamiento del elevador hidráulico **HR** Maksimalni radni raspon hidraulične dizalice **HU** A hidraulikus emelő maximális munkatartománya **RO** Intervalul maxim de lucru al ascensorului hidraulic **BG** Максимален работен обхват на хидравличния крик

 **DE** Minimaler Arbeitsbereich des Säulenhebers **EN** The minimum working range of a post jack **FR** Plage de travail minimale du cric bouteille **ES** Alcance mínimo del elevador de columna **HR** Minimalni radni raspon stupne dizalice **HU** Az oszlopemelő minimális munkatartománya **RO** Intervalul minim de lucru al ascensorului de stâlpi **BG** Минималният работен обхват на хидравличния крик

 **DE** Maximaler Arbeitsbereich des Säulenhebers **EN** Maximum working range of a post jack **FR** Plage de travail maximale du cric bouteille **ES** Alcance máximo del elevador de columna **HR** Maksimalni radni raspon stupne dizalice **HU** Az oszlopemelő maximális munkatartománya **RO** Intervalul maxim de lucru al ascensorului de stâlpi **BG** Максимален работен обхват на хидравличния крик

 **DE** Maßeinheit für den Druck **EN** Unit of measure for pressure **FR** Unité de mesure de la pression **ES** Unidad de medida de la presión **HR** Jedinica mjerenja tlaka **HU** A nyomás mértékegysége **RO** Unitatea de măsură a presiunii **BG** Мерна единица за налягане

 **DE** Lichtfarbe **EN** The color of the light **FR** Couleur de la lumière **ES** Color de la luz **HR** Boja svjetla **HU** A fény színe **RO** Culoarea luminii **BG** Цветът на светлината

 **DE** Maßeinheit des Lichtstroms **EN** Unit of measurement for the luminous flux **FR** Unité de mesure du flux lumineux **ES** Unidad de medida del flujo luminoso **HR** Jedinica mjere svjetlosnog snopa **HU** A fénysáram mértékegysége **RO** Unitatea de măsură a fluxului luminos **BG** Мерна единица за светлинния поток

 **DE** Druckeinheit (Pfund pro Quadratzoll) **EN** Pressure unit (pound per square inch) **FR** Unité de pression (livre par pouce carré) **ES** Unidad de presión (libra por pulgada cuadrada) **HR** Jedinica tlaka (pound per square inch) **HU** Nyomás mértékegysége (font/négyzetüvelyk) **RO** Unitatea de presiune (pound per square inch) **BG** Единица за налягане

 **DE** Mikrometer **EN** Micrometer **FR** Micromètre **ES** Micrómetro **HR** Mikrometar **HU** Mikrométer **RO** Micrometru **BG** Микрометър

 **DE** Mikrometer **EN** Micrometer **FR** Micromètre **ES** Micrómetro **HR** Mikrometar **HU** Mikrométer **RO** Micrometru **BG** Микрометър

 **DE** Niutonmeter **EN** Newton meter **FR** Niutonmètre **ES** Niutómetro **HR** Njuntmetar **HU** Newtonométer **RO** Niutonometru **BG** Нютон метър

 **DE** Durchmesser des Rohrs **EN** Pipe diameter **FR** Diamètre du tuyau **ES** Diámetro del tubo **HR** Promjer cijevi **HU** Csőtátmérő **RO** Diametru țevii **BG** Диаметър на тръбата

 **DE** Arbeitsbereich der Innenzange **EN** Working range of internal pliers **FR** Plage de travail des pinces intérieures **ES** Rango de funcionamiento de las pinzas interiores **HR** Radni raspon unutarnjih kljesta **HU** A belső fogó munkatartománya **RO** Intervalul de funcționare a cleștilor interioari **BG** Работен диапазон на вътрешни клещи

 **DE** Arbeitsbereich der Außenzange **EN** Working range of external pliers **FR** Plage de travail des pinces extérieures **ES** Rango de funcionamiento de los alicates exteriores **HR** Radni raspon vanjskih kljesta **HU** A külső fogó munkatartománya **RO** Intervalul de funcționare a cleștilor exteriori **BG** Работен диапазон на външни клещи

 **DE** Durchmesser des Bohrers **EN** Drill diameter **FR** Diamètre du foret **ES** Diámetro de la broca **HR** Promjer svrdla **HU** Fűrő átmérő **RO** Diametru burghuiului **BG** Диаметър на средлото

 **DE** Durchmesser des Zwei-Stufen-Bohrers **EN** Two-step drill diameter **FR** Diamètre du foret à deux étages **ES** Diámetro de la broca de dos etapas **HR** Promjer dvostupanjskog svrdla **HU** Két-fokozatú fűrőfű átmérő **RO** Diametru burghuiului în două etape **BG** Диаметър на двустепенно средло

 **DE** Durchmesser des Klebstoffs **EN** Glue diameter **FR** Diamètre de la colle **ES** Diámetro de la cola **HR** Promjer ljepila **HU** Melegasztó átmérő **RO** Diametrul de lipire **BG** Диаметър на лепило

 **DE** Scheibendurchmesser **EN** Wheel blade diameter **FR** Diamètre du disque **ES** Diámetro del disco **HR** Promjer diska **HU** Tárcsa átmérő **RO** Diametru discului **BG** Диаметър на циферблата

 **DE** Querschnitt der stromführenden Leitung **EN** Cross-section of the electrical cable **FR** Section transversale du fil conducteur **ES** Sección transversal de la línea de conducción de corriente **HR** Presjek strujnog voda **HU** Áramvezető vezeték keresztmetszete **RO** Secțiunea transversală a firului de curent **BG** Напречно сечение на токовия проводник

 **DE** Querschnitt der stromführenden Leitung **EN** Cross-section of the electrical cable **FR** Section transversale du fil conducteur **ES** Sección transversal de la línea de conducción de corriente **HR** Presjek strujnog voda **HU** Áramvezető vezeték keresztmetszete **RO** Secțiunea transversală a firului de curent **BG** Напречно сечение на токов проводник

 **DE** Maximaler Durchmesser **EN** Maximum diameter **FR** Diamètre maximal **ES** Diámetro máximo **HR** Maksimalni promjer **HU** Maximális átmérő **RO** Diametrul maxim **BG** Максимален диаметър

 **DE** Maximaler Rohrdurchmesser **EN** Maximum pipe diameter **FR** Diamètre maximal du tuyau **ES** Diámetro máximo del tubo **HR** Maksimalni promjer cijevi **HU** Maximális csőátmérő **RO** Diametru maxim al țevii **BG** Максимален диаметър на тръбата

 **DE** Größen der Ausdreher **EN** Sizes of screw extractors **FR** Tailles des extracteurs **ES** Tamaños de los extractores de tornillo **HR** Veličine ekstraktorâ vijaka **HU** A csavarhúzó méretei **RO** Dimensiunile extractoraelor **BG** Размери на отвертки

 **DE** 30 % leichter **EN** 30% lighter **FR** 30% plus légers **ES** 30% más ligero **HR** 30% lakši **HU** 30%-kal könnyebb **RO** 30% mai ușoar **BG** 30% по-лека

 **DE** Gewichtseinheit, 1 Kilogramm **EN** Unit of mass, 1 kilogram **FR** Unité de poids, 1 kilogramme **ES** Unidad de masa, 1 kilogramo **HR** Jedinica mase, 1 kilogram **HU** Tömeg mértékegység, 1 kg **RO** Unitate de greutate, 1 kilogram **BG** Единица за тегло, 1 килограм

 **DE** Gewichtseinheit, 5 Kilogramm **EN** Unit of mass, 5 kilograms **FR** Unité de poids, 5 kilogrammes **ES** Unidad de masa, 5 kilogramos **HR** Jedinica mase, 5 kilograma **HU** Tömeg mértékegység, 5 kilogram **RO** Unitate de greutate, 5 kilograme **BG** Единица за тегло, 5 килограма

 **DE** Gewichtseinheit, 2 Tonnen **EN** Mass unit 2 tons **FR** Unité de poids 2 tonnes **ES** Unidad de masa 2 toneladas **HR** Jedinica mase 2 tone **HU** Súly mértékegység 2 tonna **RO** Unitate de greutate 2 tone **BG** Единица за тегло, 2 тона

 **DE** Maximale Belastung **EN** Maximum loading **FR** Charge maximale **ES** Carga máxima **HR** Maksimalno opterećenje **HU** Maximális terhelés **RO** Sarcina maximă **BG** Максимално натоварване

 **DE** Maximales Gewicht 12 Kilogramm **EN** Maximum weight 12 kilograms **FR** Poids maximum 12 kilogrammes **ES** Masa máxima 12 kilogramos **HR** Maksimalna masa 12 kilograma **HU** Maximális súly 12 kilogram **RO** Greutate maximă 12 kilograme **BG** Максимално тегло 12 кг

 **DE** Maximale Belastung **EN** Maximum loading **FR** Charge maximale **ES** Carga máxima **HR** Maksimalno opterećenje **HU** Maximális terhelés **RO** Sarcina maximă **BG** Максимално натоварване

 **DE** Klebstoffverbrauch in Gramm pro Minute **EN** Glue consumption capacity in grams per minute **FR** Consommation de colle **EN** grammes par minute **ES** Capacidad de consumo de cola **EN** gramos por minuto **HR** Učinkovitost potrošnje ljepila grama u minuti **HU** A ragasztófogyasztás teljesítménye gramm-ban percenként **RO** Consumul de adeziv in grame pe minut **BG** Производителност на консумация на лепило в грамове/минута

 **DE** Kapazität der Spritzpistole **EN** Spray gun efficiency **FR** Capacité du pistolet de peinture **ES** Rendimiento de la pistola **HR** Učinkovitost pistolja za lakiranje **HU** A festékpisztoly teljesítménye **RO** Capacitatea pistolului de pulverizare **BG** Производителност на pistoleta за ЛАКИРАНЕ

 **DE** Luftverbrauch der Spritzpistole **EN** Spray gun air intake **FR** Consommation d'air du pistolet de peinture **ES** Consumo de aire de la pistola **HR** Potrošnja zraka pistolja za lakiranje **HU** A festékpisztoly levegőfogyasztása **RO** Consumul de aer al pistolului de pulverizare **BG** Всмукване на въздух от пулверизатор

 **DE** Messgenauigkeit der Wasserwaage **EN** The accuracy of the level measurements **FR** Précision de mesure du niveau à bulle **ES** Precisión de la medición del nivel **HR** Točnost mjerenja libele **HU** A vízmerék mérési pontossága **RO** Precizia de măsurare a nivelei cu bulă de aer **BG** Точността на измерванията на нивелир

 **DE** 3 Libellen in der Wasserwaage **EN** 3 vials in the spirit level **FR** 3 indicateurs dans le niveau à bulles **ES** 3 viales **EN** el nivel de burbuja **HR** Libela 3 u 1 **HU** 3 libella a vízmeréken **RO** 3 bule în nivela cu bulă de aer **BG** 3 либели в нивелира

 **DE** 2 Libellen in der Wasserwaage **EN** 2 vials in the spirit level **FR** 2 indicateurs dans le niveau à bulles **ES** 2 viales **EN** el nivel de burbuja **HR** Libela 2 u 1 **HU** 2 libella a vízmeréken **RO** 2 bule în nivela cu bulă de aer **BG** 2 либели в нивелира

 **DE** Spitzenwinkel des Bohrers **EN** Point angle of the drill **FR** Angle de la pointe du foret **ES** Angulo de punta de la broca **HR** Kut oštrina svrdla **HU** Fűrőhegy szöge **RO** Unghiul vârfului burghuiului **BG** Точков ъгъл на средлото

 **DE** Drehbarer Schraubstockfuß **EN** Swivel base of vice **FR** Base d'étai pivotante **ES** Base giratoria para mordazas **HR** Okretna baza škripca **HU** Elfordítható satu alátét **RO** Bază de mențină pivotantă **BG** Въртяща се основа на менгемето

 **DE** Drehen des Rohrs **EN** Rotating the tube **FR** Rotation du tube **ES** Girar el tubo **HR** Okretanje tube **HU** Cső elforgatás **RO** Rotirea tubului **BG** Завъртане на тръбата

 **DE** Minimaler Schnittbereich für Metall **EN** Minimum metal cutting range **FR** Plage de coupe minimale des métaux **ES** Rango mínimo de corte de metal **HR** Minimalni raspon rezanja metala **HU** Minimális fémvágási tartomány **RO** Intervalul minim de tăiere a metalelor **BG** Минимален диапазон на рязане на метал

 **DE** Minimaler Schnittbereich für MDF **EN** Minimum cutting range of MDF **FR** Plage de coupe minimale du MDF **ES** Rango mínimo de corte de MDF **HR** Minimalni raspon rezanja MDF-a **HU** Minimális MDF vágási tartomány **RO** Interval

 **DE** Für Kupferkabel bis zu einem Durchmesser von 0,5 mm **EN** For copper cables up to 0.5 mm in diameter **FR** Pour les câbles de cuivre jusqu'à 0,5 mm de diamètre **ES** Para cables de cobre de hasta 0,5 mm de diámetro **HR** Za bakrene kablove promjera do 0,5 mm **HU** Legfeljebb 0,5 mm átmérőjű rézkábelekhöz **RO** Pentru cabluri de cupru cu diametru de până la 0,5 mm **BG** За медни кабели с диаметър до 0,5 мм

 **DE** Anzahl der Blätter **EN** Quantity of blades **FR** Nombre de lames **ES** Número de cuchillas **HR** Broj oštrica **HU** Pengék száma **RO** Număr de lame **BG** Брой остриета

 **DE** Anzahl der trapezförmigen Klingen **EN** Quantity of trapezoidal blades **FR** Nombre de lames trapézoïdales **ES** Número de hojas trapezoidales **HR** Broj trapeznih oštrica **HU** Trapéz pengék száma **RO** Număr de lame trapezoidale **BG** Брой трапецовидни остриета

 **DE** 2 Sägeblätter **EN** 2 straight saw blades **FR** 2 lames de scie **ES** 2 hojas de sierra **HR** 2 lista **HU** 2 fűrészlap **RO** 2 pânze de ferăstrău **BG** 2 режещи листа

 **DE** 2 Klemmen **EN** 2 clamps **FR** 2 pinces **ES** 2 abrazaderas **HR** 2 stege **HU** 2 szorító **RO** 2 cleme **BG** 2 скоби

 **DE** 6 Schneidräder **EN** 6 cutting wheels **FR** 6 roues de coupe **ES** 6 discos de corte **HR** 6 reznih kotačića **HU** 6 vágókorong **RO** 6 roți de tăiere **BG** 6 режещи кола

 **DE** Anzahl der Bits **EN** Quantity of sockets **FR** Nombre d'embouts **ES** Número de anexos **HR** 6 reznih kotačića **HU** Dugókulcsok száma **RO** Numărul de capace **BG** Брой контакти

 **DE** 4 austauschbare Köpfe **EN** 4 interchangeable heads **FR** 4 têtes amovibles **ES** 4 cabezas intercambiables **HR** 4 izmjenjivih glava **HU** 4 cserélhető fej **RO** 4 capete interschimbabile **BG** 4 сменяеми глави

 **DE** 5 austauschbare Köpfe **EN** 5 interchangeable heads **FR** 5 têtes amovibles **ES** 5 cabezas intercambiables **HR** 5 izmjenjivih glava **HU** 5 cserélhető fej **RO** 5 capete interschimbabile **BG** 5 сменяеми глави

 **DE** Nietkopfgößen **EN** Sizes of the riveter heads **FR** Tailles des têtes de la riveteuse **ES** Tamaños de cabeza de remache **HR** Veličina glava za alat za zakivanje **HU** Szegszelőfej méretek **RO** Dimensiuni capuri de nituire **BG** Замерите на главите на нитовете

 **DE** Kapazität **EN** Capacity **FR** Capacité **ES** Capacidad **HR** Zapremina **HU** űrtartalom **RO** Capacitate **BG** Капацитет

 **DE** Kapazität **EN** Capacity **FR** Capacité **ES** Capacidad **HR** Zapremina **HU** űrtartalom **RO** Capacitate **BG** Капацитет

 **DE** 1000 Heftklammern **EN** 1000 staples **FR** 1000 agrafes **ES** 1000 grapas **HR** Uložak za klamerica od 1000 komada **HU** 1000 tűzőkarocs **RO** 1000 de capace **BG** 1000 скоби

 **DE** Länge ausgedrückt in Millimetern **EN** Length in millimeters **FR** Longueur exprimée **EN** milímetros **ES** Longitud expresada **EN** milímetros **HR** Dužina izražena u milimetrima **HU** Milliméterben kifejezett hosszúság **RO** Lungime exprimată în milimetri **BG** Дължина, изразена в милиметри

 **DE** Messgenauigkeit des Messschiebers **EN** Caliper measuring accuracy **FR** Précision de mesure du pied à coulisse **ES** Precisión de medición del calibrador **HR** Točnost mjerenja **Sublera HU** A tolómérő mérési pontossága **RO** Precizia de măsurare a sublerului **BG** Точност на измерване на шублера

 **DE** Messbereich des Messschiebers **EN** Caliper measuring range **FR** Plage de mesure du pied à coulisse **ES** Rango de medición del calibrador **HR** Mjerni raspon **Sublera HU** A tolómérő mérési tartománya **RO** Intervalul de măsurare a sublerului **BG** Обхват на измерване на шублера

 **DE** Dicke der Klinge **EN** Blade thickness **FR** Épaisseur de la lame **ES** Espesor de la hoja **HR** Debljina oštrice **HU** Penge vastagság **RO** Grosimea lamei **BG** Дебелина на острието

 **DE** Breite der Klinge **EN** Blade width **FR** Largeur de la lame **ES** Anchura de la hoja **HR** Širina oštrice **HU** Penge szélesség **RO** Lățimea lamei **BG** Ширина на острието

 **DE** Größe der Hakenklinge **EN** Hook blade size **FR** Taille de la lame à crochet **ES** Tamaño de la hoja del gancho **HR** Veličina lukaste oštrice **HU** A kampós penge mérete **RO** Dimensiunea lamei de cârlig **BG** Размер на острието на хуката

 **DE** Dicke des Aluminiumrahmens **EN** Thickness of the aluminum frame **FR** Épaisseur du cadre **EN** aluminium **ES** Espesor del marco de aluminio **HR** Debljina aluminijskog okvira **HU** Alumínium keret vastagság **RO** Grosimea cadrului din aluminiu **BG** Дебелината на алуминиевата рамка

 **DE** Dicke des Aluminiumrahmens **EN** Thickness of the aluminum frame **FR** Épaisseur du cadre **EN** aluminium **ES** Espesor del marco de aluminio **HR** Debljina aluminijskog okvira **HU** Alumínium keret vastagság **RO** Grosimea cadrului din aluminiu **BG** Дебелината на алуминиевата рамка

 **DE** Dicke des Bandes **EN** Thickness of the tape **FR** Épaisseur du ruban **ES** Espesor de la cinta **HR** Debljina trake **HU** Szalagvastagság **RO** Grosimea benzii **BG** Дебелината на лентата

 **DE** Länge des Sägeblatts für Gipskartonplatten **EN** Length of the plasterboard saw [G-K] **FR** Longueur de la scie pour plaques de plâtre **ES** Longitud de la cuchilla para placas de yeso **HR** Dužina pile za gipskartonske ploče **HU** Gipszkarton fűrészlap hosszúság **RO** Lungimea fierăstrăului pentru plăci de gips-carton **BG** Дължина на триона за гипскартон

 **DE** Länge der Rückensäge **EN** Length of the backsaw **FR** Longueur de la scie à main **ES** Longitud de la hoja de la cresta **HR** Dužina ručne pile za drvo **HU** Japán fűrész hosszúság **RO** Lungimea fierăstrăului drept **BG** Дължина на преден трион

 **DE** Länge der Lochsäge **EN** Length of the hole saw **FR** Longueur de la scie cloche **ES** Longitud de la sierra **HR** Dužina krune za izrezvanje rupa **HU** Lyukfúró penge hosszúság **RO** Lungimea fierăstrăului sabie **BG** Дължината на циркулярен трион

 **DE** Länge der Nietmaschine **EN** Length of the riveter **FR** Longueur de la riveteuse **ES** Longitud de la remachadora **HR** Dužina klijesta za zakivanje **HU** Szegszelő hosszúság **RO** Lungimea scutei de nituire **BG** Дължината на ниткачка

 **DE** Länge des Magnethalers **EN** Length of the magnetic handle **FR** Longueur du support magnétique **ES** Longitud del soporte magnético **HR** Dužina magnetne drške **HU** Mágneses tartó hosszúság **RO** Lungimea suportului magnetic **BG** Дължината на магнитната държач

 **DE** Tiefe der magnetischen Schale **EN** Magnetic bowl depth **FR** Profondeur du bol magnétique **ES** Profundidad de la cubeta magnética **HR** Dubina magnetne posude **HU** Mágneses tálmélység **RO** Adâncimea bolului magnetic **BG** Дълбочина на магнитната купа

 **DE** Tiefe der magnetischen Schale **EN** Magnetic bowl depth **FR** Profondeur du bol magnétique **ES** Profundidad de la cubeta magnética **HR** Dubina magnetne posude **HU** Mágneses tálmélység **RO** Adâncimea bolului magnetic **BG** Дълбочина на магнитната купа

 **DE** Durchmesser des Spiegels **EN** Mirror diameter **FR** Diamètre du miroir **ES** Diámetro del espejo **HR** Promjer ogledalca **HU** Tükör átmérő **RO** Diametrul oglinzii **BG** Диаметър на огледалото

 **DE** Größe des Spiegels **EN** Mirror size **FR** Taille du miroir **ES** Tamaño del espejo **HR** Veličina ogledalca **HU** Tükör méret **RO** Dimensiunea oglinzii **BG** Размер на огледалото

 **DE** Länge der Schraubendreher Spitze **EN** Screwdriver bit length **FR** Longueur de l'embout du tournevis **ES** Longitud de la hoja **HR** Dužina vrha odvijača **HU** Csavarhúzó vég hosszúság **RO** Lungimea tijei de șurubelniță **BG** Дължина на бита на отвертката

 **DE** Heftklammer-Typ **EN** Type of staple **FR** Type d'agrafe **ES** Tipo de grapa **HR** Vrsta punjenja za klamerice **HU** Tűzőkarocs típus **RO** Tipul de capsă **BG** Вид скоби

 **DE** Breite der Heftklammer **EN** Width of the staple **FR** Largeur de l'agrafe **ES** Ancho de la grapa **HR** Širina punjenja za klamerice **HU** Tűzőkarocs szélesség **RO** Lățimea capsei **BG** Ширина на скоби

 **DE** Länge ausgedrückt in Metern **EN** Length in meters **FR** Longueur exprimée **EN** mètres **ES** Longitud expresada **EN** metros **HR** Dužina izražena u metrima **HU** Hosszúság méterben kifejezve **RO** Lungime exprimată în metri **BG** Дължина, изразена в метри

 **DE** Anzahl ausgedrückt in Stück **EN** Quantity in pieces **FR** Quantité exprimée **EN** unités **ES** Cantidad expresada **EN** unidades **HR** Količina izražena u komadima **HU** Darabban kifejezett mennyiség **RO** Cantitate exprimată în unități **BG** Количество, изразено в парчета

 **DE** Länge ausgedrückt in Zoll **EN** Length in inches **FR** Longueur exprimée **EN** pouces **ES** Longitud expresada **EN** pulgadas **HR** Dužina izražena u incima **HU** Hosszúság kifejezett hosszúság **RO** Lungime exprimată în inci **BG** Дължина в инчове

 **DE** Größe der Bits in Zoll **EN** Socket size in inches **FR** Taille des embouts **EN** pouces **ES** Tamaño de las tomas **EN** pulgadas **HR** Veličina nastavka u incima **HU** Az aljzatok mérete hüvelykben **RO** Dimensiunea capetelor în inci **BG** Размер на гнездото в инчове

 **DE** Ratschengröße in Zoll **EN** Ratchet size in inches **FR** Taille du cliquet **EN** pouces **ES** Tamaño de la carraca **EN** pulgadas **HR** Veličina čegrtaljke u incima **HU** A racsni mérete hüvelykben **RO** Dimensiunea cheii cu clichet în inci **BG** Размерът на тресчотката в инчове

 **DE** Ratschengröße in Zoll **EN** Ratchet size in inches **FR** Taille du cliquet **EN** pouces **ES** Tamaño de la carraca **EN** pulgadas **HR** Veličina čegrtaljke u incima **HU** A racsni mérete hüvelykben **RO** Dimensiunea cheii cu clichet în inci **BG** Размерът на тресчотката в инчове

 **DE** Schlüsselgröße in Zoll **EN** Wrench size in inches **FR** Taille de la clé **EN** pouces **ES** Tamaño de la llave **EN** pulgadas **HR** Veličina ključa u incima **HU** Kulcsméret hüvelykben **RO** Dimensiunea cheii în inci **BG** Размер на гаечен ключ в инчове

 **DE** Größe der Bits in Zoll **EN** Socket size in inches **FR** Taille des embouts **EN** pouces **ES** Tamaño de las tomas **EN** pulgadas **HR** Veličina nastavka u incima **HU** Az aljzatok mérete hüvelykben **RO** Dimensiunea capetelor în inci **BG** Размер на гнездото в инчове

 **DE** Größe der Bits in Zoll **EN** Socket size in inches **FR** Taille des embouts **EN** pouces **ES** Tamaño de las tomas **EN** pulgadas **HR** Veličina nastavka u incima **HU** Az aljzatok mérete hüvelykben **RO** Dimensiunea capetelor în inci **BG** Размер на гнездото в инчове

 **DE** Größe der Bits in Zoll **EN** Socket size in inches **FR** Taille des embouts **EN** pouces **ES** Tamaño de las tomas **EN** pulgadas **HR** Veličina nastavka u incima **HU** Az aljzatok mérete hüvelykben **RO** Dimensiunea capetelor în inci **BG** Размер на гнездото в инчове

 **DE** 4 Eckkappen **EN** 4 corner end caps **FR** 4 capuchons d'angle **ES** 4 tapas de esquina **HR** 4 kutne kapice **HU** 4 saroktartó **RO** 4 capace de colț **BG** 4 ъглови капачки

 **DE** Adapter für Schraubendreherbits 1,4 Zoll **EN** Adapter for 1.4 inch screwdriver bits **FR** Adaptateur pour embouts de tournevis 1.4 pouce **ES** Adaptador para puntas de destornillador de 1.4 pulgadas **HR** Adapter za vrhove za odvijač 1.4 inča **HU** Adapter csavarhúzóhegyekhez 1.4 inch **RO** Adaptor pentru biți de șurubelniță de 1.4 inch **BG** Адаптер за битове за отвертка 1.4 инча

 **DE** Zum Schneiden von Aluminium **EN** For cutting aluminum **FR** Pour couper l'aluminium **ES** Para cortar aluminio **HR** Za rezanje aluminijske **HU** Alumínium vágáshoz **RO** Pentru tăierea aluminiului **BG** За рязане на алуминий

 **DE** Zum Schneiden von Stahl **EN** For cutting steel **FR** Pour couper l'acier **ES** Para cortar acero **HR** Za rezanje čelika **HU** Acél vágáshoz **RO** Pentru tăierea oțelului **BG** За рязане на стомана

 **DE** Zum Schneiden von Stahl **EN** For cutting steel **FR** Pour couper l'acier **ES** Para cortar acero **HR** Za rezanje čelika **HU** Acél vágáshoz **RO** Pentru tăierea oțelului **BG** За рязане на стомана

 **DE** Zum Schneiden von Stahl **EN** For cutting steel **FR** Pour couper l'acier **ES** Para cortar acero **HR** Za rezanje čelika **HU** Acél vágáshoz **RO** Pentru tăierea oțelului **BG** За рязане на стомана

 **DE** Zum Schneiden von Kunststoffen **EN** For cutting plastics **FR** Pour couper les matières plastiques **ES** Para cortar plásticos **HR** Za rezanje sintetike **HU** Műanyag vágáshoz **RO** Pentru tăierea materialelor plastice **BG** За рязане на пластмаси

 **DE** Gesamtlänge 140 mm **EN** Overall length 140 mm **FR** Longueur totale 140 mm **ES** Longitud total 140 mm **HR** Sveukupna dužina 140 mm **HU** Teljes hosszúság 140 mm **RO** lungime totală 140 mm **BG** Обща дължина 140 мм

 **DE** Länge des Arbeitsteils 140 mm **EN** Working part length 140 mm **FR** Longueur de la partie utile 140 mm **ES** Longitud de la pieza de trabajo 140 mm **HR** Dužina radnog dijela 140 mm **HU** Munkavégző rész hosszúság 140 mm **RO** Lungimea părții de lucru 140 mm **BG** Дължина на работната част 140 мм

 **DE** Länge des Arbeitsteils 50 mm **EN** Working part length 50 mm **FR** Longueur de la partie utile 50 mm **ES** Longitud de la pieza de trabajo 50 mm **HR** Dužina radnog dijela 50 mm **HU** Munkavégző rész hosszúság 50 mm **RO** Lungimea părții de lucru 50 mm **BG** Дължина на работната част 50 мм

 **DE** Länge des Arbeitsteils 50 mm **EN** Working part length 50 mm **FR** Longueur de la partie utile 50 mm **ES** Longitud de la pieza de trabajo 50 mm **HR** Dužina radnog dijela 50 mm **HU** Munkavégző rész hosszúság 50 mm **RO** Lungimea părții de lucru 50 mm **BG** Дължина на работната част 50 мм

 **DE** Länge des Bandes 4 m **EN** Length of tape 4 m **FR** Longueur du ruban 4m **ES** Longitud de la cinta 4 m **HR** Dužina trake 4 m **HU** Szalag hosszúság 4 m **RO** Lungime bandă 4 m **BG** Дължина на лента 4 м

 **DE** Tiefe 45 mm **EN** Depth 45 mm **FR** Profondeur 45 mm **ES** Profundidad 45 mm **HR** Dubina 45 mm **HU** Mélység 45 mm **RO** Adâncime 45 mm **BG** Дълбочина 45 мм

 **DE** Anzahl der Zyklen 100.000 **EN** Quantity of cycles 100,000 **FR** Nombre de cycles 100 000 **ES** Número de ciclos 100 000 **HR** Broj ciklusa 100 tis **HU** Ciklusszám 100 ezer **RO** Număr de cicluri 100 mi **BG** Брой цикли 100 000

 **DE** Anzahl der Reihen und Bündel pro Reihe **EN** Quantity of rows and bundles in a row **FR** Nombre de rangées et de faisceaux par rangée **ES** Número de filas y haces por fila **HR** Broj redaka i snopova u redu **HU** Sorok és kötegek száma soronként **RO** Numărul de rânduri și fascicule pe rând **BG** Брой редове и пакети в ред

 **DE** Anzahl der Zähne pro Zoll **EN** Teeth per inch **FR** Nombre de dents par pouce **ES** Número de dientes por pulgada **HR** Broj zubi u 1 inču **HU** Fogak száma hüvelykentre **RO** Numărul de dinți pe 1 inch **BG** Брой зъби на 1 инч

 **DE** Quadratische Spitze 5 mm **EN** 5 mm square bit **FR** Embout carré 5 mm **ES** 5 mm extremo cuadrado **HR** Kvadratni vrh 5 mm **HU** Négyszögletes vég 5 mm **RO** Bit pătrat 5 mm **BG** Квадратен връх 5 мм

 **DE** Quadratische Spitze 8 mm **EN** 8 mm square bit **FR** Embout carré 8 mm **ES** Extremo cuadrado 8 mm **HR** Kvadratni vrh 8 mm **HU** Négyszögletes vég 8 mm **RO** Bit pătrat 8 mm **BG** Квадратен връх 8 мм

 **DE** Quadratische Spitze konisch 6, 7, 8, 9 mm **EN** Conical square bit 6, 7, 8, 9 mm **FR** Embout conique carré 6, 7, 8, 9 mm **ES** Extremo cuadrado cónico 6, 7, 8, 9 mm **HR** Kvadratni konusni vrh 6, 7, 8, 9 mm **HU** Négyszögletes kúpos vég 6, 7, 8, 9 mm **RO** Bit pătrat conic 6, 7, 8, 9 mm **BG** Конусен квадратен връх 6, 7, 8, 9 мм

 **DE** Dreieckige Spitze 10 mm **EN** 10 mm triangular bit **FR** Extrémité triangulaire 10 mm **ES** Extremo triangular 10 mm **HR** Trokutni vrh 10 mm **HU** Háromszögletű vég 10 mm **RO** Bit triunghiular 10 mm **BG** 10 мм триъгълен връх

 **DE** Zweiseitige Schraubendreher Spitze 6 mm **PH2** **EN** Reversible screwdriver bit 6 mm **PH2** **FR** Embout de tournevis réversible 6 mm **PH2** **ES** Punta de destornillador de doble punta de 6 mm **PH2** **HR** Dvostrani bit za odvijač 6 mm **PH2** **HU** Megfordítható csavarhúzó biféj 6 mm **PH2** **RO** Bit dublu de șurubelniță 6 mm **PH2** **BG** Двустраничен бит за отвертка 6 mm **PH2**

 **DE** Zweiseitige Schraubendreher Spitze 7 mm **PH2** **EN** Reversible screwdriver bit 7 mm **PH2** **FR** Embout de tournevis réversible 7 mm **PH2** **ES** Punta de destornillador de doble punta de 7 mm **PH2** **HR** Dvostrani bit za odvijač 7 mm **PH2** **HU** Megfordítható csavarhúzóhöz 7 mm **PH2** **RO** Bit dublu de șurubelniță 7 mm **PH2** **BG** Двустраничен бит за отвертка 7 mm **PH2**

 **DE** Spatelspitze 9 mm **EN** 9 mm spade bit **FR** Embout à bêche 9 mm **ES** Punta de pala 9 mm **HR** Lopatasti vrh 9 mm **HU** 9 mm -es pengehegy **RO** Bit spatulă 9 mm **BG** 9 мм връх на острието

 **DE** Maximaler Rohrdurchmesser 110 mm **EN** Max diameter of pipes 110 mm **FR** Diamètre maximal des tuyaux 110 mm **ES** Diámetro máximo del tubo 110 mm **HR** Max promjer cijevi 110 mm **HU** Max csőátmérő 110 mm **RO** Diametru maxim al țevilor 110 mm **BG** Максимален диаметър на тръбите 110 mm

 **DE** Maximaler Rohrdurchmesser 35 mm **EN** Max diameter of pipes 35 mm **FR** Diamètre maximal des tuyaux 35 mm **ES** Diámetro máximo del tubo 35 mm **HR** Max promjer cijevi 35 mm **HU** Max csőátmérő 35 mm **RO** Diametru maxim al țevilor 35 mm **BG** Максимален диаметър на тръбите 35 mm

 **DE** Kartusche 190 g **EN** Nabój 190g **FR** Cartouche 190g **ES** Cartucho 190g **HR** Patrona 190g **HU** Patron 190g **RO** Cartuș 190g **BG** Касера 190гр

 **DE** HSS-Klingendurchmesser 35 mm **EN** HSS blade diameter 35 mm **FR** Lame HSS diamètre 35 mm **ES** Diámetro de la hoja HSS 35 mm **HR** Oštrica s HSS promjera 35 mm **HU** HSS penge átmérő 35 mm **RO** Diametru lamei HSS 35 mm **BG** Диаметър на острието HSS 35 mm

 **DE** Metrische Skala **EN** Metric graduation **FR** Échelle métrique **ES** Escala métrica **HR** Metričko mjerilo **HU** Metrikus skála **RO** Scară metrică **BG** Метричен мащаб

 **DE** Taste AUTO START\_STOP **EN** AUTO START\_STOP button **FR** Touche AUTO START\_STOP **ES** Botón AUTO START\_STOP **HR** Tipka AUTO START\_STOP **HU** AUTO START\_STOP gomb **RO** Buton AUTO START\_STOP **BG** AUTO START\_STOP бутон

 **DE** TWIST-Anschluss **EN** TWIST connection type **FR** Raccordement TWIST **ES** Conexión tipo TWIST **HR** Priključak tipa TWIST **HU** TWIST típusú csatlakozás **RO** Conexiune de tip TWIST **BG** TWIST връзка

 **DE** Kontrolle der Flamme **EN** Flame regulation **FR** Réglage de la flamme **ES** Control de la llama **HR** Regulacija plamena **HU** Lángvezérlés **RO** Controlul flăcării **BG** Регулиране на пламяка

 **DE** S-förmige Backen **EN** S-shaped jaws **FR** Mâchoire **EN** forme de S **ES** Mandíbulas **EN** forma de S **HR** Čeljusti u obliku slova S **HU** alakú pófák **RO** făci în formă de S **BG** S-образни челюсти

 **DE** Gasart - MAPP **EN** Gas type - MAPP **FR** Type de gaz - MAPP **ES** Tipo de gas - MAPP **HR** Tip plina - MAPP **HU** Gáztipus - MAPP **RO** Tipul de gaz - MAPP **BG** Тип газ - MAPP

 **DE** Arbeitsbereich 1/2 Zoll-2 Zoll **EN** Working range 1/2 inch-2 inch **FR** Plage de travail 1/2 pouce-2 pouces **ES** Rango de trabajo 1/2 pulgada-2 pulgadas **HR** Radni raspon 1/2 inča - 2 inča **HU** Munkatartomány 1/2 hüvelyk - 2 hüvelyk **RO** Interval de lucru 1/2 inch - 2 inch **BG** Работен диапазон 1,2 инча-2 инча

 **DE** Arbeitsbereich 20 - 60 mm **EN** Working range 20-60 mm **FR** Plages de travail 20 - 60 mm **ES** Rango de trabajo 20-60 mm **HR** Radni raspon 20-60 mm **HU** Munkatartomány 20 - 60 mm **RO** Interval de lucru 20-60 mm **BG** Работен диапазон 20-60 мм

 **DE** Ersatzklinge **EN** Spare blade **FR** Lame de rechange **ES** Cuchilla de recambio **HR** Rezervne oštrice **HU** Tartalék penge **RO** Lamă de rezervă **BG** Резервно острие

 **DE** Gasverbrauch 123 g/h **EN** Gas consumption 123 g/h **FR** Consommation de gaz 123 g/h **ES** Consumo de gas 123 g/h **HR** Potrošnja plina 123 g/h **HU** Gázfogyasztás 123 g/h **RO** Consumul de gaz 123 g/h **BG** Разход на газ 123 g/h

 **DE** Luftverbrauch 113 L/min **EN** Air consumption 113 L/min **FR** Consommation d'air 113 L/min **ES** Consumo de aire 113 L/min **HR** Potrošnja zraka 113 L/min **HU** Levegőfogyasztás 113 L/min **RO** Consumul de aer 113 L/min **BG** Консумация на въздух 113 л\_мин

 **DE** Luftverbrauch 142 L/min **EN** Air consumption 142 L/min **FR** Consommation d'air 142 L/min **ES** Consumo de aire 142 L/min **HR** Potrošnja zraka 142 L/min **HU** Levegőfogyasztás 142 L/min **RO** Consumul de aer 142 L/min **BG** Консумация на въздух 142 л\_мин

 **DE** Li-Ion 600 mA Batterie **EN** Li-Ion 600 mA battery **FR** Batterie Li-Ion 600 mA **ES** Batería de iones de litio 600 mA **HR** Baterija Li-Ion 600 mA **HU** 600 mA Li-Ion elem **RO** Baterie Li-Ion de 600 mA **BG** Li-Ion 600 mA батерия

 **DE** Li-Ion 900 mA Batterie **EN** Li-Ion 900 mA battery **FR** Batterie Li-Ion 900 mA **ES** Batería de iones de litio de 900 mA **HR** Baterija Li-Ion 900 mA **HU** Li-Ion 900 mA elem **RO** Baterie Li-Ion de 900 mA **BG** Литиево-ионна батерия 900 mA

 **DE** I. Gang der Temperaturregelung 250 L\_min 50-450°C **EN** Stage I of temperature regulation 250 L\_min 50-450°C **FR** Vitesses I du régulateur de température 250 L\_min 50-450°C **ES** Control de la temperatura de funcionamiento I 250 L\_min 50-450°C **HR** Brzina I regulacije temperature 250 L\_min 50-450°C **HU** Hőmérséklet-szabályozó I fokozat 250 L\_min 50-450°C **RO** Treapta I de reglare a temperaturii 250 L\_min 50-450°C **BG** Етан I на температурен контрол 250 L\_min 50-450 ° C

 **DE** I. Gang der Temperaturregelung 300 L\_min 350°C **EN** Stage I of temperature regulation 300 L\_min 350 ° C **FR** Vitesses I du régulateur de température 300 L\_min 350°C **ES** Control de la temperatura de funcionamiento I 300 L\_min 350°C **HR** Brzina I regulacije temperature 300 L\_min 350°C **HU** Hőmérséklet-szabályozó I fokozat 300 L\_min 350 ° C **RO** Treapta I de reglare a temperaturii 300 L\_min 350°C **BG** Етан I на температурен контрол 300 L\_min 350 ° C

 **DE** II. Gang der Temperaturregelung 500 L\_min. 60-600 °C **EN** Stage II of temperature regulation 500 L\_min 60-600 ° C **FR** Vitesses II du régulateur de température 500 L\_min 60-600°C **ES** Run II control de temperatura 500 L\_min 60-600°C **HR** Brzina II regulacije temperature 500 L\_min 60-600°C **HU** Hőmérséklet-szabályozó II fokozat 500 L\_min 60-600°C **RO** Treapta II de reglare a temperaturii 500 L\_min 60-600°C **BG** Етан II на температурен контрол 500 L\_min 60-600 ° C

 **DE** II. Gang der Temperaturregelung 500 L\_min 600°C **EN** Stage II of temperature regulation 500 L\_min 600 ° C **FR** Vitesses II du régulateur de température 500 L\_min 600°C **ES** Run II control de temperatura 500 L\_min 600°C **HR** Brzina II regulacije temperature 500 L\_min 600°C **HU** Hőmérséklet-szabályozó II fokozat 500 L\_min 600 ° C **RO** Treapta II de reglare a temperaturii 500 L\_min 600°C **BG** Етан II на температурен контрол 500 L\_min 600 ° C

 **DE** II. Gang der Temperaturregelung 550 L\_min. 100-600 °C **EN** Stage II of temperature regulation 550 L\_min 100-600 ° C **FR** Vitesses II du régulateur de température 550 L\_min 100-600°C **ES** Run II control de temperatura 550 L\_min 100-600°C **HR** Brzina II regulacije temperature 550 L\_min 100-600°C **HU** Hőmérséklet-szabályozó II fokozat 550 L\_min 100-600 ° C **RO** Treapta II de reglare a temperaturii 550 L\_min 100-600°C **BG** Етан II на температурен контрол 550 L\_min 100-600 ° C

 **DE** Kühlung bei 50°C und 280 L\_min **EN** Cooling at 50° C temperature and 280 L\_min **FR** Refroidissement à 50°C et 280 L\_min **ES** Enfriamiento a 50°C y 280 L\_min **HR** Hlađenje na temperaturi 50°C i broju okretaja 280 L\_min **HU** Hűtés 50°C-on és 280 L\_per fordulatszám alatt **RO** Răcire la temperatura de 50°C și turatăii de 280 L\_min **BG** Охлаждане при 50 ° C и 280 L\_min

 **DE** Ergonomischer Griff **EN** Ergonomic handle **FR** Poignée ergonomique **ES** Asa ergonómica **HR** Ergonomska drška **HU** Ergonomikus fogantyú **RO** Mâner ergonomic **BG** Ергономична дръжка

 **DE** Leistung 13 W **EN** Power 13 W **FR** Puissance 13 W **ES** 13 W de potencia **HR** Snaga 13 W **HU** Teljesítmény 13 W **RO** Putere 13 W **BG** Мощност 13 W.

 **DE** LED-Beleuchtung **EN** LED lighting **FR** Éclairage LED **ES** Iluminación LED **HR** LED rasvjeta **HU** LED világítás **RO** Iluminare LED **BG** LED осветление

 **DE** Getriebe x 5 **EN** x5 stages **FR** Engrenage x 5 **ES** Caja de cambios x 5 **HR** Zupčanik x 5 **HU** Áttételt. x 5 **RO** Cutie de viteze x 5 **BG** Предаване x 5

 **DE** Drehzahl 10000-32000 U/min **EN** Rotation speed 10000-32000 rpm **FR** Vitesses 10000-32000 tr/min **ES** Velocidad 10000-32000 rpm **HR** Okretna brzina 10000-32000 okr\_min **HU** Fordulatszám 10000-32000 ford\_perc **RO** Viteza turatăii 10000-32000 rpm **BG** Скорост на въртене 10000-32000 об / мин

 **DE** Wolframcarbidge-Fräser 2 Stück **EN** 2 pcs tungsten carbide cutter **FR** Fraises **EN** carbure de tungstène 2 pcs **ES** Fresas de carburo de tungsteno 2 piezas **HR** Fina dijelja od volframovog karbida 2 kom **HU** Volfrámkarbid húzórudak, 2 db **RO** Freze din carbură de tungsten 2 buc **BG** Фрезези за волфрамов карбид 2 бр

 **DE** Mabuchi-Motor **EN** Mabuchi engine **FR** Moteur Mabuchi **ES** Motor Mabuchi **HR** Motor Mabuchi **HU** Mabuchi motor **RO** Motor Mabuchi **BG** Двигател Mabuchi

 **DE** Temperatur max. 600°C **EN** Temperature max 600°C **FR** Température max. 600°C **ES** Temperatura máx. 600°C **HR** Temperatura max 600°C **HU** Hőmérséklet max 600°C **RO** Temperatura maximă 600°C **BG** Максимална температура 600 ° C

 **DE** Elastische Welle **EN** Flexible shaft **FR** Arbre flexible **ES** Eje flexible **HR** Elastični valjak **HU** Rugalmas tengely **RO** Arbore flexibil **BG** Гъвкав вал

 **DE** Stromversorgung 230 V 50 Hz **EN** Power supply 230 V 50 Hz **FR** Alimentation 230 V 50 Hz **ES** Alimentación 230 V 50 Hz **HR** Napajanje 230 V 50 Hz **HU** Tápegység 230 V 50 Hz **RO** Alimentare electrică 230 V 50 Hz **BG** Захранване 230 V 50 Hz

 **DE** Spannungsversorgung 3,6 V **EN** Power supply 3.6 V **FR** Alimentation 3,6 V **ES** 3,6 V fuente de alimentación **HR** Napajanje 3,6 V **HU** Tápegység 3,6 V **RO** Alimentare 3,6 V **BG** Захранване 3,6 V

 **DE** Spannungsversorgung 7,2 V **EN** Power supply 7.2 V **FR** Alimentation 7,2 V **ES** Alimentación 7,2 V **HR** Napajanje 7,2 V **HU** Tápegység 7,2 V **RO** Alimentare 7,2 V **BG** Захранване 7,2 V

 **DE** Durchmesser des Zubehörs 3,2 mm **EN** Accessory diameter 3.2 mm **FR** Diamètre des accessoires de 3,2 mm **ES** Diámetro del accesorio 3.2 mm **HR** Promjer dodatka 3,2 mm **HU** Tartozék átmérő 3,2 mm **RO** Diametru accesorii 3,2 mm **BG** Диаметър на аксесоара 3,2 mm

 **DE** 4 austauschbare Nietköpfe **EN** 4 interchangeable riveter heads **FR** 4 têtes de rivetage amovibles **ES** 4 cabezas de remache intercambiables **HR** 4 zamjenjive glave alata za zakivanje **HU** 4 cserélhető szegescsőfej **RO** 4 capete de nituire interschimbabile **BG** 4 сменяеми глави на нитове

 **DE** T-Kopf-Nagel **EN** T-shaped nail **FR** Clou à tête **EN** T **ES** Clavo **T** **HR** Čavov s glavom tipa T **HU** T-fejű szög **RO** Cui pentru cap de tip T **BG** T-образен пирон

 **DE** Leistung 100 W **EN** Power 100 W **FR** Puissance 100 W **ES** 100 W de potencia **HR** Snaga 100 W **HU** Teljesítmény 100 W **RO** Putere 100 W **BG** 100 W мощност

 **DE** Nietkopfgößen **EN** Sizes of the riveter heads **FR** Tailles des têtes de la riveteuse **ES** Tamaños de cabeza de remache **HR** Veličine glava za alat za zakivanje **HU** Szegescsőfej méretek **RO** Dimensiuni capuri de nituire **BG** Размерите на главите на нитовете

 **DE** Betriebstemperatur des Klebstoffs 120-150 °C **EN** Working temperature of glue 120-150 ° C **FR** Température de service de la colle 120-150°C **ES** Temperatura de trabajo del adhesivo 120-150°C **HR** Radna temperatura lepila 120-150°C **HU** A ragasztó munkahőmérséklete 120-150°C **RO** Temperatura de funcționare a adezivului 120-150°C **BG** Работна температура на лепилото 120-150 ° C

 **DE** J-Typ-Klammern **EN** J-type staples **FR** Agrafes de type J **ES** Grapas tipo J **HR** Punjenje za klamerice tipa J **HU** J típusú tűzőkapcsok **RO** Capse de tip J **BG** Скоби тип J

 **DE** Französische Steckdose **EN** French type socket **FR** Prise française **ES** Toma de corriente francesa **HR** Utičnica francuskog tipa **HU** Francia típusú aljzat **RO** Priză franceză **BG** гнездо за френски тип

 **DE** Flache Spitze 3 mm **EN** FR Embout plat 3 mm **ES** Hoja plana de 3 mm **HR** Ravni bit 3 mm **HU** 3 mm-es lapos hegy **RO** Vârf plat 3 mm **BG** 3 мм плоское острие

 **DE** Französische Steckdose **EN** French type socket **FR** Prise française **ES** Toma de corriente francesa **HR** Utičnica francuskog tipa **HU** Francia típusú aljzat **RO** Priză franceză **BG** гнездо за френски тип

 **DE** Flache Spitze 3 mm **EN** FR Embout plat 3 mm **ES** Hoja plana de 3 mm **HR** Ravni bit 3 mm **HU** 3 mm-es lapos hegy **RO** Vârf plat 3 mm **BG** 3 мм плоское острие

 **DE** Koaxialkabel Triset 113-Profi-11 **EN** Triset 113-Profi-11 coaxial cables **FR** Câbles coaxiaux Triset 113-Profi-11 **ES** Cables coaxiales Triset 113-Profi-11 **HR** Koncentrični kablovi Triset 113-Profi-11 **HU** Koaxiális kábeltek Triset 113-Profi-11 **RO** Cabluri coaxiale Triset 113-Profi-11 **BG** Triset 113-Profi-11 коаксиални кабели

 **DE** Maximale Belastung 3600 W **EN** Maximum 3600 W **FR** Charge maximale 3600 W **ES** Carga máxima 3600 W **HR** Maksimalno opterećenje 3600 W **HU** Maximális terhelés 3600 W **RO** Sarcina maximă 3600 W **BG** Максимално натоварване 3600 W

 **DE** Maximale Belastung 4000 W **EN** Maximum 4000 W **FR** Charge maximale 4000 W **ES** Carga máxima 4000 W **HR** Maksimalno opterećenje 4000 W **HU** Maximális terhelés 4000 W **RO** Sarcina maximă 4000 W **BG** 4000 W максимално натоварване

 **DE** Ratschenmechanismus **EN** Ratchet mechanism **FR** Mécanisme à cliquet **ES** Mecanismo de trinquete **HR** Mehaniizam čegrtaljke **HU** Racsnis mechanizmus **RO** Mecanism cu clichet **BG** Механизъм на тресотката

 **DE** Leiterquerschnitt 3 x 1-5 mm<sup>2</sup> **EN** Wire cross-section 3 x 1-5 mm<sup>2</sup> **FR** Section du conducteur 3 x 1-5 mm<sup>2</sup> **ES** Sección del conductor 3 x 1-5 mm<sup>2</sup> **HR** Presjek voda 3 x 1-5 mm<sup>2</sup> **HU** Kábel keresztmetszete 3 x 1-5 mm<sup>2</sup> **RO** Secțiunea transversală a cablului 3 x 1-5 mm<sup>2</sup> **BG** Напречно сечение на проводника 3 x 1-5 mm<sup>2</sup>

 **DE** Leiterquerschnitt 3 x 2-5 mm<sup>2</sup> **EN** Wire cross-section 3 x 2-5 mm<sup>2</sup> **FR** Section du conducteur 3 x 2-5 mm<sup>2</sup> **ES** Sección del conductor 3 x 2-5 mm<sup>2</sup> **HR** Presjek voda 3 x 2-5 mm<sup>2</sup> **HU** Kábel keresztmetszete 3 x 2-5 mm<sup>2</sup> **RO** Secțiunea transversală a cablului 3 x 2-5 mm<sup>2</sup> **BG** Напречно сечение на проводника 3 x 2-5 mm<sup>2</sup>

 **DE** Leiterquerschnitt 3 x 2-5 mm<sup>2</sup> **EN** Wire cross-section 3 x 2-5 mm<sup>2</sup> **FR** Section du conducteur 3 x 2-5 mm<sup>2</sup> **ES** Sección del conductor 3 x 2-5 mm<sup>2</sup> **HR** Presjek voda 3 x 2-5 mm<sup>2</sup> **HU** Kábel keresztmetszete 3 x 2-5 mm<sup>2</sup> **RO** Secțiunea transversală a cablului 3 x 2-5 mm<sup>2</sup> **BG** Напречно сечение на проводника 3 x 2-5 mm<sup>2</sup>

 **DE** Datenkommunikationskabel 4P 6P 8P **EN** Telecommunication cables 4P 6P 8P **FR** Câbles de télécommunication 4P 6P 8P **ES** Cables de comunicación de datos 4P 6P 8P **HR** Tele-informacijski vodovi 4P 6P 8P **HU** Távforgalmi kábelek 4P 6P 8P **RO** Cabluri de telecomunicații 4P 6P 8P **BG** Телекомуникационни кабели 4P 6P 8P

 **DE** Drahtstärke 0,5 - 5 mm<sup>2</sup> **EN** Wire thickness 0,5 - 5 mm<sup>2</sup> **FR** Fil d'une épaisseur de 0,5 - 5 mm<sup>2</sup> **ES** Espesor del cable 0,5 - 5 mm<sup>2</sup> **HR** Vod debljine 0,5 - 5 mm<sup>2</sup> **HU** Kábelvastagság 0,5 - 5 mm<sup>2</sup> **RO** Grosimea cablului 0,5 - 5 mm<sup>2</sup> **BG** Дебелина на телта 0,5 - 5 mm<sup>2</sup>

 **DE** Drahtstärke 8 - 13 mm<sup>2</sup> **EN** Wire thickness 8 - 13 mm<sup>2</sup> **FR** Fil d'une épaisseur de 8 - 13 mm<sup>2</sup> **ES** Espesor del cable 8 - 13 mm<sup>2</sup> **HR** Vod debljine 8 - 13 mm<sup>2</sup> **HU** Kábelvastagság 8 - 13 mm<sup>2</sup> **RO** Grosimea cablului 8 - 13 mm<sup>2</sup> **BG** Дебелина на телта 8 - 13 mm<sup>2</sup>

 **DE** Kabelisolierung Typ H05RR-F **EN** Cable insulation type H05RR-F **FR** Type d'isolation du câble H05RR-F **ES** Aislamiento del conductor tipo H05RR-F **HR** Vrsta izolacije voda H05RR-F **HU** H05RR-F típusú kábelszigetelés **RO** Tipul de izolație a cablului H05RR-F **BG** Кабелна изолация тип H05RR-F

 **DE** Kabelisolierung Typ H07RN-F **EN** Cable insulation type H07RN-F **FR** Type d'isolation du câble H07RN-F **ES** Tipo de aislamiento del cable H07RN-F **HR** Vrsta izolacije voda H07RN-F **HU** H07RN-F típusú kábelszigetelés **RO** Tipul de izolație a cablului H07RN-F **BG** Кабелна изолация тип H07RN-F

 **DE** Steckertyp RG59 **EN** Type of the connector RG59 **FR** Type de raccord RG59 **ES** Conector tipo RG59 **HR** Vrsta spojnice RG59 **HU** RG59 típusú csatlakozó **RO** Tip conector RG59 **BG** Тип конектор RG59

 **DE** Steckertyp RG6 **EN** Type of the connector RG6 **FR** Type de raccord RG6 **ES** Conector tipo RG6 **HR** Vrsta spojnice RG6 **HU** RG6 típusú csatlakozó **RO** Tip conector RG6 **BG** Тип конектор RG6

 **DE** Steckertyp RJ



**IP54** DE Isolationsklasse des Messschiebers **EN** Insulation class of the caliper **FR** Catégorie d'isolation du pied à coulisse **ES** Clase de aislamiento del calibrador **HR** Klasa izolacije šublера **HU** A tolómérő szigetelési osztálya **RO** Clasa de izolare a etrierului **BG** Клас на изолация на шублера

**SELF LOCK** DE Selbstverriegelndes Bandmaß **EN** Self-locking measure **FR** Mesure autobloquante **ES** Instrumento de medición con autobloqueo **HR** Metar s auto-blokomad **HU** Önzáró tolómérő **RO** Ruletă de măsură cu autoblocare **BG** Самозаклочваща се марка

**WWW 10 FOLDS** DE Gliedermaßstab mit 10 Segmenten **EN** Measure folding on 10 segments **FR** Mesure pliable 10 segments **ES** Medida de plegado de 10 segmentos **HR** Sklopivi metar 10 segmenata **HU** 10 részes összehajtható mérőlélek **RO** Metru pliant 10 segmente **BG** Ролетка свгаема на 10 сегмента

**WW 6 FOLDS** DE Gliedermaßstab mit 6 Segmenten **EN** Measure folding on 6 segments **FR** Mesure pliable 6 segments **ES** Medida de plegado de 6 segmentos **HR** Sklopivi metar 6 segmenata **HU** 6 részes összehajtható mérőlélek **RO** Metru pliant 6 segmente **BG** Ролетка свгаема на 6 сегмента

**ANTI SHOCK** DE Stofffest **EN** Impact resistant **FR** Résistant aux chocs **ES** Resistente a los impactos **HR** Otporan na udarce **HU** Ütésálló **RO** Rezistentă la impact **BG** Устойчив на удар

**MEMORY x 30** DE Speicher für 30 Messungen **EN** Memory for 30 measurements **FR** Mémoire de 30 mesures **ES** Memoria para 30 mediciones **HR** Memorija 30 mjerenja **HU** 30 mérés memória **RO** Memorie pentru 30 de măsurători **BG** Памет на 30 измервания

**m m<sup>2</sup> mm<sup>3</sup>** DE Messung von Länge, Volumen und Oberfläche **EN** Measurement of volume, length and surface **FR** Mesure de la longueur, du volume et de la surface **ES** Medición de la longitud del volumen y de la superficie **HR** Mjerenje dužine volumena i površine **HU** Térfogat, felület és hosszúság mérése **RO** Măsurarea lungimii volumului și a suprafeței **BG** Измерване на обем и дължина на повърхността

**90° 45°** DE Messung unter einem Winkel von 45-90° **EN** Measurement at an angle 45-90° **FR** Mesure à un angle de 45-90° **ES** Medición en un ángulo de 45-90° **HR** Mjerenje pod kutom 45-90° **HU** 45-90°-os szögben történő mérés **RO** Măsurare la un unghi de 45-90° **BG** Измерване под ъгъл 45-90°

**90°** DE Messung unter einem Winkel von 90° **EN** Measurement at an angle 0-90° **FR** Mesure à un angle de 90° **ES** Medición en un ángulo de 90° **HR** Mjerenje pod kutom 90° **HU** 90°-os szögben **RO** Măsurare la un unghi de 90° **BG** Измерване под ъгъл 90°

**0/45/90°** DE Füllstandsmessung in einem Winkel von 0-45-90° **EN** Measurement of level at an angle of 0-45-90° **FR** Mesure du niveau à un angle de 0-45-90° **ES** Medición del nivel en un ángulo de 0-45-90° **HR** Mjerenje razine pod kutom 0-45-90° **HU** Szintmérés 0-45-90°-os szögben **RO** Măsurarea nivelului la un unghi de 0-45-90° **BG** Измерване на нивото под ъгъл 0-45-90°

**0/90°** DE Füllstandsmessung in einem Winkel von 0-90° **EN** Measurement of level at an angle of 0-90° **FR** Mesure du niveau à un angle de 0-90° **ES** Medición del nivel en un ángulo de 0-90° **HR** Mjerenje razine pod kutom 0-90° **HU** Szintmérés 0-90°-os szögben **RO** Măsurarea nivelului la un unghi de 0-90° **BG** Измерване на нивото под ъгъл 0-90°

**TWO MILLED SURFACES** DE Gefräste Seitenkante der Wasserwaage **EN** Milled side edge of the spirit level **FR** Bord latéral fraisé du niveau à bulle **ES** Borde fresado del nivel de burbuja **HR** Glodani bočni rubi libele **HU** Hornyolt szintmérő oldalsó él **RO** Margine laterală frezată a nivelei cu bulă de aer **BG** Фрезоз страничен ръб на нивелира

**3x SPEED** DE Bandspulenge triebe 1-3 **EN** Transmission for winding of tape 1-3 **FR** Engrenage d'enroulement du ruban 1-3 **ES** Engranaje de bobina a bobina 1-3 **HR** Zupčanik za namotavanje trake 1-3 **HU** Szalagszélváltó sebességváltó 1-3 **RO** Angrenaj pentru înfășurare bandă 1-3 **BG** Колан за навиване на колана 1-3

**TWO SIDES** DE Zweiseitige Skala **EN** Two-sided scale **FR** Échelle double face **ES** Balanza de dos caras **HR** Dvostrana ljestvica **HU** Kétoldalas skála **RO** Scară pe două fețe **BG** Двустранна скала

**MAGNETIC** DE Klebeband mit Magneten **EN** Tape with magnets **FR** Ruban avec aimants **ES** Cinta con imanes **HR** Traka s magnetima **HU** Szalag mágnesekkel **RO** Bandă cu magneti **BG** Лента с магнити

**HOLDER** DE Gürtelhalter **EN** Handle for belt **FR** Crochet de ceinture **ES** Clip para el cinturón **HR** Kopče za remen **HU** Övtartó **RO** Suport pentru centură **BG** Щипка за колан

**MAGNETIC** DE Eingebaute Magnete **EN** Built-in magnets **FR** Aimants intégrés **ES** Imanes incorporados **HR** Ugrađeni magneti **HU** Beépített mágnesek **RO** Magnetii încorporați **BG** Вградени магнити

**VERTICAL VIEW** DE Vertikale Ansicht **EN** Vertical view **FR** Vue verticale **ES** Vista vertical **HR** Vertikalni pogled **HU** Függőleges nézet **RO** Vedere verticală **BG** Вертикален изглед

**Cu 50 mm** DE Cu-Erkennung bis zu einer Tiefe von 50 mm **EN** Detection of Cu up to a depth of 50 mm **FR** Détection Cu jusqu'à une profondeur de 50 mm **ES** Detección de Cu hasta una profundidad de 50 mm **HR** Detekcija Cu do dubine 50 mm **HU** Cu érzékelés 50 mm mélységig **RO** Detectarea Cu până la o adâncime de 50 mm **BG** Откриване на Си до дълбочина 50 mm

**Cu 80 mm** DE Cu-Erkennung bis zu einer Tiefe von 80 mm **EN** Detection of Cu up to a depth of 80 mm **FR** Détection Cu jusqu'à une profondeur de 80 mm **ES** Detección de Cu hasta una profundidad de 80 mm **HR** Detekcija Cu do dubine 80 mm **HU** Cu érzékelés 80 mm mélységig **RO** Detectarea Cu până la o adâncime de 80 mm **BG** Откриване на Си до дълбочина 80 mm

**38 mm** DE Holzerkennung bis zu einer Tiefe von 38 mm **EN** Detection of wood up to a depth of 38 mm **FR** Détection du bois jusqu'à une profondeur de 38 mm **ES** Detección de madera hasta una profundidad de 38 mm **HR** Detekcija drveta do dubine 38 mm **HU** Fa érzékelés 38 mm mélységig **RO** Detectarea lemnului până la o adâncime de 38 mm **BG** Откриване на дърво до дълбочина 38 mm

**50 mm** DE Erkennung von Leitungen unter Spannung 50 mm **EN** Detection of live-wires 50 mm **FR** Détection de câbles sous la tension 50 mm **ES** Detección de cables EN tensión 50 mm **HR** Detekcija vodova pod naponom 50 mm **HU** Feszültség alatt álló kábelek érzékelése 50 mm **RO** Detectarea cablurilor sub tensiune 50 mm **BG** Откриване на проводници под напрежение 50 mm

**m** DE Berechnung der Maße nach dem Satz des Pythagoras **EN** Calculating of dimension according to the Pythagorean **FR** Calcul de la dimension selon le principe de Pythagore **ES** Cálculo de la dimensión según el principio pitagórico **HR** Izračunavanje dimenzije prema pitagorejskom principu **HU** A méret kiszámítása a Pitagorasz-érv szerint **RO** Calcularea dimensiunii conform principiului lui Pitagora **BG** Изчисляване на измерението според питагорейския принцип

**POCKET SIZE** DE Taschenformat **EN** Pocket dimension **FR** Dimension de poche **ES** Dimensión de bolsillo **HR** Džepna veličina **HU** Zsebméret **RO** Dimensiune de buzunar **BG** Джебен размер

**CR 2032 BATTERY** DE Stromversorgung über eine CR2032-Batterie **EN** Powered by CR2032 battery **FR** Alimenté par une pile CR2032 **ES** Alimentación Batería CR2032 **HR** Napajanje baterija CR2032 **HU** CR2032 elemmel működik **RO** Alimentat de o baterie CR2032 **BG** Захранва се от батерия CR2032

**FAST SPEED** DE Erhöhte Aufrollgeschwindigkeit **EN** Increased winding speed **FR** Vitesse d'enroulement accrue **ES** Mayor velocidad de bobinado **HR** Povećana brzina namotavanja **HU** Megnövelt felcséveselési sebesség **RO** Viteză de înfășurare crescută **BG** Повишена скорост на навиване

**DURABLE** DE Erhöhte Lebensdauer **EN** Increased endurance **FR** Durabilité accrue **ES** Mayor durabilidad **HR** Povećana čvrstoća **HU** Megnövelt tartósság **RO** Durabilitate crescută **BG** Повишена издръжливост

**ORGANISERS** DE 2 Organizer **EN** 2 organizers **FR** 2 compartiments **ES** 2 organizadores **HR** 2 organizatora **HU** 2 szervező **RO** 2 organizatori **BG** 2 организатора

**3 modules** DE 3 Module **EN** 3 modules **FR** 3 modules **ES** 3 módulos **HR** 3 modula **HU** 3 modul **RO** 3 module **BG** 3 модула

**5 SEGMENTS** DE 5 Teile **EN** five-piece **FR** 5 parties **ES** 5 partes **HR** 5 - dijelna **HU** 5 részes **RO** 5 părți **BG** 5 части

**ABS** DE ABS-Taschenlampe **EN** ABS flashlight **FR** Torche ABS **ES** Antorcha ABS **HR** ABS ručna svjetiljka **HU** ABS zseblámpa **RO** Lanternă ABS **BG** Фенерче ABS

**ADJUSTABLE PARTITIONS** DE Einstellbare Trennwände **EN** Adjustable dividers **FR** Compartiments réglables **ES** Separadores ajustables **HR** Podesive pregrade **HU** Állítható elválasztók **RO** Separatoare reglabile **BG** Регулируеми разделители

**15 DIVIDERS** DE Anzahl der Trennwände **EN** Q-ty of dividers **FR** Nombre de compartiments **ES** Número de compartimentos **HR** Količina pregrada **HU** A rekeszek száma **RO** Număr de partiții **BG** Брой дялове 15

**TRUCK 12 kg** DE Maximales Gewicht 12 kg **EN** Maximum weight 12 kg **FR** Poids maximale 12 kg **ES** Masa máxima 12 kg **HR** Maksimalna težina 12 kg **HU** Maximális súly 12 kg **RO** Greutate maximă 12 kg **BG** Максимално тегло 12 кг

**1x15 kg 410x210x260 mm** DE Tragfähigkeit des unteren Segments 15 kg **EN** Load capacity of the bottom section 15 kg **FR** Capacité de charge du segment inférieur 15 kg **ES** Capacidad de carga del segmento inferior 15 kg **HR** Nosivost donjeg segmenta 15 kg **HU** Az alsó szegmens teherbírása 15 kg **RO** Capacitatea de încărcare a segmentului inferior 15 kg **BG** Товарносимостта на долната част е 15 кг

**1x20 kg 420x220x150 mm** DE Tragfähigkeit des oberen Segments 20 kg **EN** Load capacity of the top section 20 kg **FR** Capacité de charge du segment supérieur 20 kg **ES** Capacidad de carga del segmento superior 20 kg **HR** Nosivost gornjeg segmenta 20 kg **HU** A felső szegmens teherbírása 20 kg **RO** Capacitatea de încărcare a segmentului superior 20 kg **BG** Товарносимостта на горния сегмент 20 кг

**2x5 kg 390x215x260 mm** DE Tragfähigkeit des mittleren Segments 2x5 kg **EN** Load capacity of the middle section is 2x5 kg **FR** Capacité de charge du segment central 2x5 kg **ES** Capacidad de carga del segmento central 2x5 kg **HR** Nosivost srednjeg segmenta 2x5 kg **HU** A középső szegmens teherbírása 2x5 kg **RO** Capacitatea de încărcare a segmentului central 2x5 kg **BG** Товарносимостта на средната част 2x5 кг

**UP TO 20 PARTITIONS** DE Einstellbare Trennwände bis zu 20 Stück **EN** Adjustable dividers q-ty up to 20 **FR** Compartiments réglables jusqu'à 20 **ES** Cantidad de divisores ajustables hasta 20 **HR** Podesive pregrade broj do 20 **HU** Akár 20 állítható elválasztó **RO** Compartimente reglabile cu număr de până la 20 **BG** Регулируеми отделения до 20

**UP TO 30 PARTITIONS** DE Einstellbare Trennwände bis zu 30 Stück **EN** Adjustable dividers q-ty up to 30 **FR** Compartiments réglables jusqu'à 30 **ES** Separadores ajustables hasta 30 **HR** Podesive pregrade broj do 30 **HU** Akár 30 állítható elválasztó **RO** Compartimente reglabile cu număr de până la 30 **BG** Регулируеми отделения до 30

**REMOVABLE TRAY** DE Abnehmbares Tablett **EN** Removable tray **FR** Plateau amovible **ES** Bandeja extraíble **HR** Izmjenjiva tacna **HU** Kivehető tálcá **RO** Tavă detașabilă **BG** Подвижна тава

**REMOVABLE ORGANISERS** DE Herausnehmbare Organizer **EN** Removable organizers **FR** Organiseurs amovibles **ES** Organizadores extraíbles **HR** Izmjenjivi organizatori **HU** Kivehető szervezők **RO** Organizatoare detașabile **BG** Подвижни организери

**LOCK** DE Schutzvorrichtung **EN** Safeguards **FR** Protection **ES** Seguridad **HR** Zaštita **HU** Védelem **RO** Protecție **BG** Защитение

**1x130 mm** DE 1 Schublade 130 mm **EN** 1 drawer 130 mm **FR** 1 tiroir 130 mm **ES** 1 cajón 130 mm **HR** 1 ladica 130 mm **HU** 1 fiók 130 mm **RO** 1 sertar 130 mm **BG** 1 чекмедже 130 мм

**1x154 mm** DE 1 Schublade 154 mm **EN** 1 drawer 154 mm **FR** 1 tiroir 154 mm **ES** 1 cajón 154 mm **HR** 1 ladica 154 mm **HU** 1 fiók 154 mm **RO** 1 sertar 154 mm **BG** 1 чекмедже 154 мм

**1x233 mm** DE 1 Schublade 233 mm **EN** 1 drawer 233 mm **FR** 1 tiroir 233 mm **ES** 1 cajón 233 mm **HR** 1 ladica 233 mm **HU** 1 fiók 233 mm **RO** 1 sertar 233 mm **BG** 1 чекмедже 233 мм

**12PT** DE 12-eckig **EN** twelve angular **FR** dodécagonal **ES** 12 ángulos **HR** 12-kutni **HU** 12 szögű **RO** 12 unghiuri **BG** 12 -ъглен

**x2 WITH BRAKES** DE 2 Lenkrollen mit Feststellern **EN** 2 steering wheels with brakes **FR** 2 roulettes pivotantes avec frein **ES** 2 ruedas giratorias con freno **HR** 2 okretna kotačića s kočnicama **HU** 2 kanyarodó kerék fékkel **RO** 2 roți pivotante cu frâne **BG** 2 колела уоукващи със спирачки

**2 COMPARTMENTS** DE 2 Trennwände **EN** 2 dividers **FR** 2 compartiments **ES** 2 tabiques **HR** 2 pregrade **HU** 2 rekesz **RO** 2 compartimente **BG** 2 отделения

**2x154 mm** DE 2 Schubladen 154 mm **EN** 2 drawers 154 mm **FR** 2 tiroirs 154 mm **ES** 2 Cajones de 154 mm **HR** 2 ladice 154 mm **HU** 2 fiók 154 mm **RO** 2 sertare de 154 mm **BG** 2 чекмеджета 154 мм

**x4 5x1,25"** DE 4 Räder 5 x 1,25 **EN** 4 wheels 5 x 1,25 **FR** 4 roulettes 5 x 1,25 **ES** 4 ruedas 5 x 1,25 **HR** 4 kotača 5 x 1,25 **HU** 4 kerék 5 x 1,25 **RO** 4 roți 5 x 1,25 **BG** 4 колела 5 x 1,25

**4x75 mm** DE 4 Schubladen 75 mm **EN** 4 drawers 75 mm **FR** 4 tiroirs 75 mm **ES** 4 cajones 75 mm **HR** 4 kotača 75 mm **HU** 4 fiók 75 mm **RO** 4 sertare de 75 mm **BG** 4 чекмеджета 75 мм

**5 PARTITIONS** DE 5 Trennwände **EN** 5 dividers **FR** 5 compartiments **ES** 5 compartimentos **HR** 5 pregrada **HU** 5 elválasztó **RO** 5 compartimente **BG** 5 отделения

**5x75 mm** DE 5 Schubladen 75 mm **EN** 5 drawers 75 mm **FR** 5 tiroirs 75 mm **ES** 5 cajones 75 mm **HR** 5 ladica 75 mm **HU** 5 fiók 75 mm **RO** 5 sertare de 75 mm **BG** 5 чекмеджета 75 мм

**6 PARTITIONS** DE 6 Trennwände **EN** 6 dividers **FR** 6 compartiments **ES** 6 compartimentos **HR** 6 pregrada **HU** 6 elválasztó **RO** 6 compartimente **BG** 6 отделения

**6x50 mm** DE 6 Schubladen 50 mm **EN** 6 drawers 50 mm **FR** 6 tiroirs 50 mm **ES** 6 cajones 50 mm **HR** 6 ladica 50 mm **HU** 6 fiók 50 mm **RO** 6 sertare de 50 mm **BG** 6 чекмеджета 50 мм

**6x75 mm** DE 6 Schubladen 75 mm **EN** 6 drawers 75 mm **FR** 6 tiroirs 75 mm **ES** 6 cajones 75 mm **HR** 6 ladica 75 mm **HU** 6 fiók 75 mm **RO** 6 sertare de 75 mm **BG** 6 чекмеджета 75 мм

**72T** DE 72 Zähne **EN** 72 teeth **FR** 72 dents **ES** Púas 72 **HR** 72 zuba **HU** 72 fog **RO** 72 de dinți **BG** 72 зъба

**SIDE DOOR** DE Seitliche Türen **EN** Side door **FR** Porte latérale **ES** Puertas laterales **HR** Bočna vrata **HU** Oldalsó ajtó **RO** Uși laterale **BG** Странична врата

**0,6 mm** DE Dicke 0,6 mm **EN** Thickness 0,6 mm **FR** Épaisseur 0,6 mm **ES** Espesor 0,6 mm **HR** Debljina 0,6 mm **HU** Vastagság 0,6 mm **RO** Grosime 0,6 mm **BG** Дебелина 0,6 мм

**0,8 mm** DE Dicke 0,8 mm **EN** Thickness 0,8 mm **FR** Épaisseur 0,8 mm **ES** Espesor 0,8 mm **HR** Debljina 0,8 mm **HU** Vastagság 0,8 mm **RO** Grosime 0,8 mm **BG** Дебелина 0,8 мм

**2 mm** DE Dicke 2 mm **EN** Thickness 2 mm **FR** Épaisseur 2 mm **ES** Espesor 2 mm **HR** Debljina 2 mm **HU** Vastagság 2 mm **RO** Grosime 2 mm **BG** Дебелина 2 мм

**UPPER STORAGE** DE Oberes Staufach **EN** Top cabinet **FR** Compartiment de rangement supérieur **ES** Compartimento superior **HR** Gornje spremište **HU** Felső tárolórekesz **RO** Compartiment de depozitare superior **BG** Горна кутия

**1000V VDE** DE Isolación do 1000V

**HEX** DE HEX-Tipp **EN** End cap **FR** Embout **HEX** **ES** HEX pieza final **HR** HEX nastavak **HU** HEX hegy **RO** Vârf **HEX** **BG** HEX Накрайник

**PH** DE PH-Tipp **EN** End cap **FR** Embout **PH** **ES** Punta PH **HR** PH nastavak **HU** PH hegy **RO** Vârf **PH** **BG** PH Накрайник

**PZ** DE PZ-Tipp **EN** End cap **FR** Embout **PZ** **ES** Punta PZ **HR** PZ nastavak **HU** PZ hegy **RO** Vârf **PZ** **BG** PZ Накрайник

**SL** DE Flache Spitze **SL** **EN** End cap flat **SL** **FR** Embout plat **SL** **ES** Punta plana **SL** **HR** Ravni nastavak **SL** **HU** Lapos **SL** hegy **RO** Vârf plat **SL** **BG** Плосък Накрайник **SL**

**TORX** DE Torx-Spitze **EN** End cap torx **FR** Embout torx **ES** Punta Torx **HR** Torx nastavak **HU** Torx hegy **RO** Vârf **Torx** **BG** Накрайник Torx

**PH/PZ** DE PH x PZ Spitzen **EN** End cap PH x PZ **FR** Embout PH x PZ **ES** Puntas PH x PZ bits **HR** Nastavci PH x PZ **HU** PH x PZ hegyek **RO** Vârf PH x PZ **BG** PH x PZ Накрайник

**15°** DE winkel 15 Grad **EN** Angle 15 degrees **FR** angle de 15 degrés **ES** ángulo 15 grados **HR** Kut 15 st **HU** 15 fokos szög **RO** unghi de 15 grade **BG** ъгъл 15 градуса

**LOCK** DE Vorhängeschloss **EN** Padlock **FR** Cadenas **ES** Candado **HR** Lokot **HU** Lakat **RO** Lacăt **BG** Катинар

**10mm** DE Sechskantantrieb **EN** HEX 10 mm **EN** 10 mm hexagonal drive **FR** Entraînement hexagonal HEX 10 mm **ES** Accionamiento hexagonal HEX 10 mm **HR** Šesterokutni pogon HEX 10 mm **HU** Hatszögletű szár HEX 10 mm **BG** HEX 10 mm Шестоъгълно задвижване

**1/4"** DE Sechskantantrieb **EN** HEX 1\_4 Zoll **EN** 1\_4 inch hexagonal drive **FR** Entraînement hexagonal HEX 1\_4 pouce **ES** Accionamiento hexagonal HEX 1\_4 pulgadas **HR** Šesterokutni pogon HEX 1\_4 inča **HU** Hatszögletű szár HEX 1\_4 hüvelyk **RO** Dispozitiv de acționare hexagonal HEX 1\_4 inch **BG** 1\_4 инчов Шестоъгълно задвижване

**DEEP** DE Langer Aufsatz **EN** Long cap **FR** Embout long **ES** Toma larga **HR** Dugi nasadni ključ **HU** Hosszú szár **RO** Cap lung **BG** Дълъг накрайник

**low drawers MAX 15 kg** DE Tragfähigkeit der unteren Schubladen 15 kg **EN** Load capacity of low drawers 15 kg **FR** Capacité de charge des tiroirs bas 15 kg **ES** Capacidad de carga de los cajones bajos 15 kg **HR** Nosivost niskih ladicica 15 kg **HU** Az alsó nyílások terhelhetősége 15 kg **RO** Capacitatea de încărcare a sertarelor joase 15 kg **BG** Товарносимостта на ниски чекмеджета 15 кг

**high drawers MAX 25 kg** DE Tragfähigkeit der hohen Schubladen 25 kg **EN** Load capacity of high drawers 25 kg **FR** Capacité de charge des tiroirs hauts 25 kg **ES** Capacidad de carga de los cajones de alto nivel 25 kg **HR** Nosivost visokih ladicica 25 kg **HU** A magas nyílások terhelhetősége 25 kg **RO** Capacitatea de încărcare a sertarelor înalte 25 kg **BG** Товарносимостта на високи чекмеджета 25 кг

**DRAWER SELF-OPENING PROTECTION** DE Schutz gegen Selbstöffnung **EN** Protection against self-opening **FR** Protection contre l'auto-ouverture **ES** Protección contra la autoapertura **HR** Zaštita od samootvaranja **HU** Önkinyúlás elleni védelem **RO** Protecție împotriva deschiderii automate **BG** Защита срещу самоотваряне

**SELF CLOSING** DE Rollenführungen mit Schließmechanismus **EN** Ball bearing guides with closing **FR** Glissières à rouleaux avec mécanisme de fermeture **ES** Corredoras de bolas con cierre **HR** Kuglične vodilice s mekim zatvaranjem **HU** Görgös vezetők behúzással **RO** Ghidaje cu role cu mecanism de închidere **BG** Затварящи се ролкови водачи

**FLEXIBLE HEAD** DE Gelenk **EN** Flexible head **FR** Joint **ES** Bisagra **HR** Zglob **HU** Csukló **RO** Articulație **BG** Трава

**E-type** DE Typ **E** **EN** Type **E** **FR** Type **E** **ES** Tipo **E** **HR** Tip **E** **HU** E típus **RO** Tip **E** **BG** Тип **E**

**CLUB SPONGE INSERT** DE In Würfel geschnittener Schwämmeinsatz **EN** Sponge insole cut into cubes **FR** Insert éponge coupé **EN** cubos **ES** Esponja cortada **EN** cubos **HR** Spužvasti umetak narezan na kocke **HU** Kockákra vágott szivacsbetét **RO** Inserție de burete tăiată în cuburi **BG** Вложка EVA, нарязана на кубчета

**EVA INSERTS** DE EVA-Einlagen **EN** EVA insoles **FR** Semelles **EN** EVA **ES** Plantillas de EVA **HR** EVA umeci **HU** EVA betétek **RO** Inserții EVA **BG** EVA вложка

**DIN 3110** DE Gefertigt nach der Norm DIN 3110 **EN** Made in accordance with DIN 3110 **FR** Conforme à la norme DIN 3110 **ES** Fabricado según la norma DIN 3110 **HR** Izraden u skladu sa standardom DIN 3110 **HU** A DIN 3110 norma szerint gyártva **RO** Realizat conform standardului DIN 3110 **BG** Произведено в съответствие с DIN 3110

**DRAWER LOCK** DE Schubladenschloss **EN** Lock for drawer **FR** Serrure de tiroir **ES** Cerradura de cajón **HR** Brava ladice **HU** Fiokzár **RO** Încuietorea sertarului **BG** Ключалка за чекмеджета

**LOCK WITH 2 KEYS** DE Schloss mit 2 Schlüsseln **EN** Lock with 2 keys **FR** Serrure avec 2 clés **ES** Cerradura con 2 llaves **HR** Brava s 2 ključa **HU** Zár 2 kulccsal **RO** Încuietorea cu 2 chei **BG** Заключалка с 2 ключа

**3-POINT HINGES** DE 3-Punkt-Scharnier **EN** 3-point hinge **FR** Charnière à 3 points **ES** Bisagra de 3 puntos **HR** Šarke s 3 točke **HU** 3 pontos zsanér **RO** Balama în 3 puncte **BG** 3-точкова панта

**4-POINT HINGES** DE 4-Punkt-Scharnier **EN** 4-point hinge **FR** Charnière à 4 points **ES** Bisagra de 4 puntos **HR** Šarke s 4 točke **HU** 4 pontos zsanér **RO** Balama în 4 puncte **BG** 4-точкова панта

**DECOMPRESSION VALVE** DE Dekompressionsventil **EN** Decompression valve **FR** Soupape de décompression **ES** Válvula de descompresión **HR** Dekompresijski ventil **HU** Dekompressziós szelep **RO** Supapă de decompresie **BG** Декомпресионен вентил

**2,5 h** DE Leuchtzeit 2,5 h **EN** Lighting time 2.5 hours **FR** Durée d'éclairage 2,5 h **ES** Tiempo de combustión 2,5 h **HR** Vrijeme svijetljenja 2,5 h **HU** Világítási idő 2,5 óra **RO** Timp de iluminare 2,5 h **BG** време реме на осветяване 2,5 часа

**LED 3W** DE LED-Beleuchtung 3 W **EN** LED lighting 3 W **FR** Éclairage LED 3 W **ES** Iluminación LED de 3W **HR** LED rasvjeta 3 W **HU** LED világítás 3 W **RO** Iluminare cu LED-uri 3 W **BG** 3 W LED осветление



















**40 mm** DE Armabstand 40 mm **EN** Arm spacing 40 mm **FR** Distance entre les bras 40 mm **ES** Distancia del brazo 40 mm **HR** Razmak krakova 40 mm **HU** Karok közötti távolság 40 mm **RO** Distanța dintre brațe 40 mm **BG** Разстояние на рамената 40 мм

















**4x** DE Halterung für 4 Aufsätze **EN** Handle for 4 caps **FR** Support pour 4 embouts **ES** Soporte para 4 adaptadores **HR** Držač za 4 nasadna ključa **HU** Tartó 4 dugókulcshoz **RO** Suport pentru 4 adaptoare **BG** Поставка за 4 прставки

**16 m** DE Beleuchtungsreichweite 16 m **EN** Lighting range 16 m **FR** Portée de l'éclairage 16 m **ES** Alcance de la iluminación 16 m **HR** Domet svjetla 16 m **HU** Megvilágítási tartomány 16 m **RO** Raza de iluminare 16 m **BG** Обхват на осветление 16 м



















**18 m** DE Beleuchtungsreichweite 18 m **EN** Lighting range 18 m **FR** Portée de l'éclairage 18 m **ES** Alcance de la iluminación 18 m **HR** Domet svjetla 18 m **HU** Megvilágítási tartomány 18 m **RO** Raza de iluminare 18 m **BG** Обхват на осветление 18 м

**20 m** DE Beleuchtungsreichweite 20 m **EN** Lighting range 20 m **FR** Portée de l'éclairage 20 m **ES** Alcance de la iluminación 20 m **HR** Domet svjetla 20 m **HU** Megvilágítási tartomány 20 m **RO** Raza de iluminare 20 m **BG** Об

	<b>DE</b> Verlängerter Griff <b>EN</b> Extended handle <b>FR</b> Manche prolongée <b>ES</b> Asa extendida <b>HR</b> Produžena ručka <b>HU</b> Hosszabbított fogantyú <b>RO</b> Mâner extins <b>BG</b> Удължена дръжка
	<b>DE</b> Erhöhte Spannkraft <b>EN</b> Increased clamping force <b>FR</b> Force de pression accrue <b>ES</b> Mayor fuerza de sujeción <b>HR</b> Povećana sila pritiska <b>HU</b> Megnövelt szorítóerő <b>RO</b> Forță de strângere crescută <b>BG</b> Повишена сила на затягане
	<b>DE</b> Steckertyp RJ 10 <b>EN</b> RJ 10 connector <b>FR</b> Type de raccord RJ 10 <b>ES</b> Tipo de conector RJ 10 <b>HR</b> Konektor RJ 10 <b>HU</b> RJ 10 típusú csatlakozó <b>RO</b> Conector de tip RJ 10 <b>BG</b> RJ 10 конектор
	<b>DE</b> Steckertyp RJ11 RJ12 <b>EN</b> RJ11 RJ12 connector <b>FR</b> Type de raccord RJ11 RJ12 <b>ES</b> Tipo de conector RJ11 RJ12 <b>HR</b> RJ11 RJ12 konektor <b>HU</b> RJ11 RJ12 típusú csatlakozó <b>RO</b> Conector de tip RJ11 RJ12 <b>BG</b> RJ11 RJ12 конектор
	<b>DE</b> Steckertyp RJ45 <b>EN</b> RJ45 connector <b>FR</b> Type de raccord RJ45 <b>ES</b> Tipo de conector RJ45 <b>HR</b> RJ45 konektor <b>HU</b> RJ45 típusú csatlakozó <b>RO</b> Conector de tip RJ45 <b>BG</b> RJ45 конектор
	<b>DE</b> 12 Arten von Clips <b>EN</b> 12 types of clips <b>FR</b> 12 types de clips <b>ES</b> 12 tipos de clips <b>HR</b> 12 vrsta klipova <b>HU</b> 12 féle gomb <b>RO</b> 12 tipuri de agrafe <b>BG</b> 12 вида клипове
	<b>DE</b> 18 Arten von Clips <b>EN</b> 18 types of clips <b>FR</b> 18 types de clips <b>ES</b> 18 tipos de clips <b>HR</b> 18 vrsta klipova <b>HU</b> 18 féle gomb <b>RO</b> 18 tipuri de agrafe <b>BG</b> 18 вида клипове
	<b>DE</b> 2 Lenkrollen <b>EN</b> 2 swivel wheels <b>FR</b> 2 roulettes pivotantes <b>ES</b> 2 ruedas giratorias <b>HR</b> 2 okretna kotača <b>HU</b> 2 kanyarodó kerék <b>RO</b> 2 roți pivotante <b>BG</b> 2 въртящи се колела
	<b>DE</b> 2 feste Rollen <b>EN</b> 2 fixed wheels <b>FR</b> 2 roulettes fixes <b>ES</b> 2 ruedas fijas <b>HR</b> 2 fiksna kotača <b>HU</b> 2 fix kerék <b>RO</b> 2 roți fixe <b>BG</b> 2 фиксирани колела
	<b>DE</b> 3 Schraubenlängen 95, 75, 45 mm <b>EN</b> 3 screw lengths 95, 75, 45 mm <b>FR</b> 3 longueurs des vis 95, 75, 45 mm <b>ES</b> 3 longitudes de tornillos 95, 75, 45 mm <b>HR</b> 3 duljine vijaka 95, 75, 45 mm <b>HU</b> 3 csavarhosszúság 95, 75, 45 mm <b>RO</b> 3 lungimi de șuruburi 95, 75, 45 mm <b>BG</b> 3 дължини на винта 95, 75, 45 мм
	<b>DE</b> 3 Arme mit Aufsätzen 17, 19 und 21 mm <b>EN</b> 3 arms with 17, 19 and 21 mm sockets <b>FR</b> 3 bras avec douilles 17, 19 et 21 mm <b>ES</b> 3 brazos con toma de 17, 19 y 21 mm <b>HR</b> 3 kraka s nastavcima od 17, 19 i 21 mm <b>HU</b> 3 kar 17, 19 és 21 mm-es dugókulccsal <b>RO</b> 3 brațe cu capuri de 17, 19 și 21 mm <b>BG</b> 3 рамена с битове 17, 19 и 21 мм
	<b>DE</b> 6 Arten von Clips <b>EN</b> 6 types of clips <b>FR</b> 6 types de clips <b>ES</b> 6 tipos de clips <b>HR</b> 6 vrsta klipova <b>HU</b> 6 féle gomb <b>RO</b> 6 tipuri de agrafe <b>BG</b> 6 вида клипове
	<b>DE</b> 6-kant 22mm <b>EN</b> Hex 22mm <b>FR</b> hexagonal 22mm <b>ES</b> 6-ángulo 22mm <b>HR</b> Hex 22mm <b>HU</b> 6-szög 22mm <b>RO</b> 6 unghiuri 22mm <b>BG</b> Шестостен 22 мм
	<b>DE</b> 8 Arten von Clips <b>EN</b> 8 types of clips <b>FR</b> 8 types de clips <b>ES</b> 8 tipos de clips <b>HR</b> 8 vrsta klipova <b>HU</b> 8 féle gomb <b>RO</b> 8 tipuri de agrafe <b>BG</b> 8 вида клипове
	<b>DE</b> 9-Stufen-Programm <b>EN</b> 9-step program <b>FR</b> Programme à 9 niveaux <b>ES</b> Programa de 9 pasos <b>HR</b> Program od 9 koraka <b>HU</b> 9 fokozatú program <b>RO</b> Program în 9 etape <b>BG</b> Програма с 9 стъпки
	<b>DE</b> Stromstärke 100 A <b>EN</b> 100 A amperage <b>FR</b> Ampérage 100 A <b>ES</b> Amperaje 100 A <b>HR</b> Amperaža 100 A <b>HU</b> Áramerősség 100 A <b>RO</b> Amperaj 100 A <b>BG</b> 100 А ток
	<b>DE</b> Stromstärke 2, 8, 15 A <b>EN</b> 2, 8, 15 A amperage <b>FR</b> Ampérage 2, 8, 15 A <b>ES</b> Amperaje 2, 8, 15 A <b>HR</b> Amperaža 2, 8, 15 A <b>HU</b> Áramerősség 2, 8, 15 A <b>RO</b> Amperaj 2, 8, 15 A <b>BG</b> Сила на тока 2, 8, 15 А.
	<b>DE</b> Automatische Betriebsmoduswahl <b>EN</b> Automatic operating mode selection <b>FR</b> Sélection automatique du mode de fonctionnement <b>ES</b> Selección de modo automático <b>HR</b> Automatski odabir načina rada <b>HU</b> Automatikuss üzemmód kiválasztás <b>RO</b> Selectarea automată a modului de funcționare <b>BG</b> Автоматичен избор на режим на работа
	<b>DE</b> Betriebsdruck 1015 PSI <b>EN</b> Working pressure 1015 PSI <b>FR</b> Pression de service 1015 PSI <b>ES</b> Presión de funcionamiento 1015 PSI <b>HR</b> Radni pritisak 1015 PSI <b>HU</b> Üzemí nyomás 1015 PSI <b>RO</b> Presiunea de funcționare 1015 PSI <b>BG</b> Работно налягане 1015 PSI
	<b>DE</b> Für M14-Buchsen <b>EN</b> For M14 sockets <b>FR</b> Pour les douilles M14 <b>ES</b> Para tomas M14 <b>HR</b> Za utičnice M14 <b>HU</b> M14-es aljzatokhoz <b>RO</b> Pentru prize M14 <b>BG</b> За контакти M14

	<b>DE</b> Für M18-Buchsen <b>EN</b> For M18 sockets <b>FR</b> Pour les douilles M18 <b>ES</b> Para tomas M18 <b>HR</b> Za utičnice M18 <b>HU</b> M18-as aljzatokhoz <b>RO</b> Pentru prize M18 <b>BG</b> За контакти M18
	<b>DE</b> Für Trommelbremsen <b>EN</b> For drum brakes <b>FR</b> Pour les freins à tambour <b>ES</b> Para frenos de tambor <b>HR</b> Za bubanj kočnice <b>HU</b> Dobfékkekhez <b>RO</b> Pentru frâne cu tambor <b>BG</b> За барабани спирачки
	<b>DE</b> Für den Einbau und Ausbau von Halogenen <b>EN</b> For assembly and disassembly of halogen lamps <b>FR</b> Pour l'installation et le retrait des halogènes <b>ES</b> Para montar y desmontar halógenos <b>HR</b> Za montažu i demontažu halogena <b>HU</b> Halogének beszereléséhez és eltávolításához <b>RO</b> Pentru instalarea și îndepărtarea halogenilor <b>BG</b> За монтаж и демонтаж на халогени
	<b>DE</b> Für den Einbau und Ausbau von Zündkerzen und Leitungen <b>EN</b> For assembly and disassembly of wires and spark plugs <b>FR</b> Pour l'installation et le retrait des bougies d'allumage et des câbles <b>ES</b> Para el montaje y desmontaje de bujías y cables <b>HR</b> Za montažu i demontažu žica i svećice <b>HU</b> Gyújtógyertyák és kábelek beszereléséhez és eltávolításához <b>RO</b> Pentru instalarea și demontarea bujiilor și a cablurilor <b>BG</b> За монтаж и демонтаж на проводници и свещи
	<b>DE</b> Für Fahrzeuge der Marken Opel, Rover, VW, Citroen, Ford, Fiat, Peugeot, Isuzu <b>EN</b> For Opel, Rover, VW, Citroen, Ford, Fiat, Peugeot, Isuzu vehicles <b>FR</b> Pour les véhicules Opel, Rover, VW, Citroën, Ford, Fiat, Peugeot, Isuzu <b>ES</b> Para vehículos de las marcas: Opel, Rover, VW, Citroen, Ford, Fiat, Peugeot, Isuzu <b>HR</b> Za vozila Opel, Rover, VW, Citroen, Ford, Fiat, Peugeot, Isuzu <b>HU</b> A következő márkájú járművekhez Opel, Rover, VW, Citroen, Ford, Fiat, Peugeot, Isuzu <b>RO</b> Pentru vehicule marca - Opel, Rover, VW, Citroen, Ford, Fiat, Peugeot, Isuzu <b>BG</b> За автомобили Opel, Rover, VW, Citroen, Ford, Fiat, Peugeot, Isuzu
	<b>DE</b> Für Fahrzeuge VW, BMW, Audi, Ford, Skoda, SEAT <b>EN</b> For VW, BMW, Audi, Ford, Skoda, SEAT vehicles <b>FR</b> Pour les véhicules VW, BMW, Audi, Ford, Skoda, SEAT <b>ES</b> Para vehículos de las marcas: VW, BMW, Audi, Ford, Skoda, SEAT <b>HR</b> Za vozila VW, BMW, Audi, Ford, Skoda, SEAT <b>HU</b> A következő márkájú járművekhez VW, BMW, Audi, Ford, Skoda, SEAT <b>RO</b> Pentru vehicule marca - VW, BMW, Audi, Ford, Skoda, SEAT <b>BG</b> За автомобили VW, BMW, Audi, Ford, Skoda, SEAT
	<b>DE</b> Für Audi-Fahrzeuge <b>EN</b> For Audi vehicles <b>FR</b> Pour les véhicules Audi <b>ES</b> Para los vehículos Audi <b>HR</b> Za vozila Audi <b>HU</b> Audi márkájú járművekhez <b>RO</b> Pentru vehicule marca Audi <b>BG</b> За автомобили на Audi
	<b>DE</b> Für BMW-Fahrzeuge <b>EN</b> For BMW vehicles <b>FR</b> Pour les véhicules BMW <b>ES</b> Para vehículos BMW <b>HR</b> Za vozila BMW <b>HU</b> BMW márkájú járművekhez <b>RO</b> Pentru vehicule marca BMW <b>BG</b> За автомобили BMW
	<b>DE</b> Für Fiat-Fahrzeuge <b>EN</b> For Fiat vehicles <b>FR</b> Pour les véhicules Fiat <b>ES</b> Para vehículos Fiat <b>HR</b> Za vozila Fiat <b>HU</b> Fiat márkájú járművekhez <b>RO</b> Pentru vehicule marca Fiat <b>BG</b> За автомобили Fiat
	<b>DE</b> Für FORD-Fahrzeuge <b>EN</b> For FORD vechicles <b>FR</b> Pour les véhicules Ford <b>ES</b> Para vehículos FORD <b>HR</b> Za vozila FORD <b>HU</b> FORD márkájú járművekhez <b>RO</b> Pentru vehicule marca FORD <b>BG</b> За автомобили FORD
	<b>DE</b> Für Honda-Fahrzeuge <b>EN</b> For Honda vehicles <b>FR</b> Pour les véhicules Honda <b>ES</b> Para vehículos Honda <b>HR</b> Za vozila Honda <b>HU</b> Honda márkájú járművekhez <b>RO</b> Pentru vehicule marca Honda <b>BG</b> За автомобили Honda
	<b>DE</b> Für Mazda-Fahrzeuge <b>EN</b> For Mazda vehicles <b>FR</b> Pour les véhicules Mazda <b>ES</b> Para vehículos Mazda <b>HR</b> Za vozila Mazda <b>HU</b> Mazda márkájú járművekhez <b>RO</b> Pentru vehicule marca Mazda <b>BG</b> За автомобили Mazda
	<b>DE</b> Für Opel-Fahrzeuge <b>EN</b> For Opel vehicles <b>FR</b> Pour les véhicules Opel <b>ES</b> Para vehículos Opel <b>HR</b> Za vozila Opel <b>HU</b> Opel márkájú járművekhez <b>RO</b> Pentru vehicule marca Opel <b>BG</b> За автомобили на Opel
	<b>DE</b> Für Peugeot-Fahrzeuge <b>EN</b> For Peugeot vehicles <b>FR</b> Pour les véhicules Peugeot <b>ES</b> Para los vehículos Peugeot <b>HR</b> Za vozila Peugeot <b>HU</b> Peugeot márkájú járművekhez <b>RO</b> Pentru vehicule marca Peugeot <b>BG</b> За автомобили Peugeot
	<b>DE</b> Für Renault-Fahrzeuge <b>EN</b> For Renault vehicles <b>FR</b> Pour les véhicules Renault <b>ES</b> Para los vehículos Renault <b>HR</b> Za vozila Renault <b>HU</b> Renault márkájú járművekhez <b>RO</b> Pentru vehicule marca Renault <b>BG</b> За автомобили Renault
	<b>DE</b> Für Volkswagen-Fahrzeuge <b>EN</b> For Volkswagen vehicles <b>FR</b> Pour les véhicules Volkswagen <b>ES</b> Para vehículos Volkswagen <b>HR</b> Za vozila Volkswagen <b>HU</b> Volkswagen márkájú járművekhez <b>RO</b> Pentru vehicule marca Volkswagen <b>BG</b> За автомобили Volkswagen
	<b>DE</b> Für Volvo und Lexus Fahrzeuge <b>EN</b> For Volvo and Lexus vehicles <b>FR</b> Pour les véhicules Volvo et Lexus <b>ES</b> Para vehículos Volvo y Lexus <b>HR</b> Za vozila Volvo i Lexus <b>HU</b> Volvo és Lexus márkájú járművekhez <b>RO</b> Pentru vehicule marca Volvo și Lexus <b>BG</b> За превозни средства Volvo и Lexus

	<b>DE</b> Für Volvo-Fahrzeuge <b>EN</b> For Volvo vehicles <b>FR</b> Pour les véhicules Volvo <b>ES</b> Para vehículos Volvo <b>HR</b> Za vozila Volvo <b>HU</b> Volvo márkájú járművekhez <b>RO</b> Pentru vehicule marca Volvo <b>BG</b> За автомобили на Volvo
	<b>DE</b> Für VW- und Audi-Fahrzeuge <b>EN</b> For VW and Audi vehicles <b>FR</b> Pour les véhicules VW et Audi <b>ES</b> Para vehículos VW y Audi <b>HR</b> Za vozila VW i Audi <b>HU</b> VW és Audi márkájú járművekhez <b>RO</b> Pentru vehicule marca VW și Audi <b>BG</b> За автомобили VW и Audi
	<b>DE</b> Für Kupfer- und Aluminiumrohre <b>EN</b> For copper and aluminium tubes <b>FR</b> Pour les tubes EN cuivre et EN aluminium <b>ES</b> Para tubos de cobre y aluminio <b>HR</b> Za bakrene i aluminijske cijevi <b>HU</b> Réz- és alumíniumcsövekhez <b>RO</b> Pentru țevi de cupru și aluminiu <b>BG</b> За медни и алуминиеви тръби
	<b>DE</b> Für Motor - BOSCH Einspritzung <b>EN</b> For the engine - BOSCH injection <b>FR</b> Pour le moteur - injection BOSCH <b>ES</b> Al motor - Inyección BOSCH <b>HR</b> Za motor - BOSCH ubrizgavanje <b>HU</b> Motorhoz - BOSCH befecskendezés <b>RO</b> Pentru motor - injecție BOSCH <b>BG</b> За двигателя - инжектиране BOSCH
	<b>DE</b> Für Motor - DELPHI Einspritzung <b>EN</b> For the engine - DELPHI injection <b>FR</b> Pour le moteur - injection DELPHI <b>ES</b> Al motor - inyección DELPHI <b>HR</b> Za motor - DELPHI ubrizgavanje <b>HU</b> Motorhoz - DELPHI befecskendezés <b>RO</b> Pentru motor - injecție DELPHI <b>BG</b> За двигателя - инжекция DELPHI
	<b>DE</b> Für Motor - DENSO Einspritzung <b>EN</b> For the engine - DENSO injection <b>FR</b> Pour le moteur - injection DENSO <b>ES</b> Al motor - inyección DENSO <b>HR</b> Za motor - DENSO ubrizgavanje <b>HU</b> Motorhoz - DENSO befecskendezés <b>RO</b> Pentru motor - injecție DENSO <b>BG</b> За двигателя - инжектиране DENSO
	<b>DE</b> Für Motor - SIEMENS Einspritzung <b>EN</b> For the engine - SIEMENS injection <b>FR</b> Pour le moteur - injection SIEMENS <b>ES</b> Al motor - inyección SIEMENS <b>HR</b> Za motor - SIEMENS ubrizgavanje <b>HU</b> Motorhoz - SIEMENS befecskendezés <b>RO</b> Pentru motor - injecție SIEMENS <b>BG</b> За двигателя - инжектиране SIEMENS
	<b>DE</b> Für DIESEL-Motor <b>EN</b> For DISLA engine <b>FR</b> Pour le moteur DISLA <b>ES</b> Para el motor DISLA <b>HR</b> Za DISLA motor <b>HU</b> DIESEL motorhoz <b>RO</b> Pentru motor DIESEL <b>BG</b> За двигателя DISLA
	<b>DE</b> Für Sechszylinder-Motor <b>EN</b> For the six cylinder engine <b>FR</b> Pour le moteur à six cylindres <b>ES</b> Para motor de seis cilindros <b>HR</b> Za šestocilindrični motor <b>HU</b> Hathengeres motorhoz <b>RO</b> Pentru motor cu șase cilindri <b>BG</b> За шестцилиндровия двигател
	<b>DE</b> Für OHV-, OHC- und CHV-Motoren <b>EN</b> For OHV, OHC, CHV engines <b>FR</b> Pour les moteurs OHV, OHC, CHV <b>ES</b> Para motores OHV, OHC, CHV <b>HR</b> Za OHV, OHC, CHV motore <b>HU</b> OHV, OHC, CHV motorokhoz <b>RO</b> Pentru motoare OHV, OHC, CHV <b>BG</b> За двигатели OHV, OHC, CHV
	<b>DE</b> Für Ventile an Reifen und Schläuchen des Typs Schreder <b>EN</b> For Schreder tire valves and tubes <b>FR</b> Pour les valves de pneumatiques et de chambres à air de type Schreder <b>ES</b> Para válvulas de neumáticos y cámaras de aire del tipo Schreder <b>HR</b> Za ventile vanjskih guma i unutarnjih Schreder guma <b>HU</b> Schreder típusú gumabroncsok és belsőik szelepeikhez <b>RO</b> Pentru valvele de la anvelope și camere de aer de tip Schreder <b>BG</b> За клапани на гуми и тръби Schreder
	<b>DE</b> Für Serviceventile in der Kälte- und Klimatechnik <b>EN</b> For service valves in refrigeration and air conditioning <b>FR</b> Pour les vannes de service dans la réfrigération et la climatisation <b>ES</b> Para válvulas de servicio EN refrigeración y aire acondicionado <b>HR</b> Za servisne ventile u rashladnici i klima uređajima <b>HU</b> Hűtő- és légkondicionáló berendezések szervizszelepeikhez <b>RO</b> Pentru supape de serviciu în refrigerare și aer condiționat <b>BG</b> За сервисни клапани в хладилни и климатични инсталации
	<b>DE</b> Für Zündkerzen <b>EN</b> For spark plugs <b>FR</b> Pour les bougies d'allumage <b>ES</b> Para las bujías <b>HR</b> Za svećice <b>HU</b> Gyújtógyertyákhoz <b>RO</b> Pentru bujii <b>BG</b> За свещи
	
	
	
	

	<b>DE</b> Länge des Metallkopfes 150 mm <b>EN</b> Metal head length 150 mm <b>FR</b> Longueur de la tête métallique 150 mm <b>ES</b> Longitud del cabezal metálico 150 mm <b>HR</b> Dužina metalne glave 150 mm <b>HU</b> A fém fej hossza 150 mm <b>RO</b> Lungimea capului metalic 150 mm <b>BG</b> Дължината на металната глава е 150 мм
	<b>DE</b> Kabellänge 2 m <b>EN</b> Total length 2 m <b>FR</b> Longueur du câble 2m <b>ES</b> Longitud del cable 2 m <b>HR</b> Dužina kabla 2 m <b>HU</b> Kábel hosszúság 2 m <b>RO</b> Lungime cablu 2 m <b>BG</b> Дължина на кабела 2 м
	<b>DE</b> Elektronische Handbremse <b>EN</b> Electronic handbrake <b>FR</b> Frein à main électronique <b>ES</b> Freno de mano electrónico <b>HR</b> Elektonska ručna kočnica <b>HU</b> Elektronikus kézifék <b>RO</b> Frână de mână electronică <b>BG</b> Електронна ръчна спирачка
	<b>DE</b> Trapezförmiges Gewinde <b>EN</b> Trapezoidal thread <b>FR</b> Filet trapezoidal <b>ES</b> Rosca trapezoidal <b>HR</b> Trapezni navoj <b>HU</b> Trapez menet <b>RO</b> Filet trapezoidal <b>BG</b> Трапецвидна нишка
	<b>DE</b> Anschlussgewinde metrisch M10 x 1 <b>EN</b> Metric connecting threads M10 x 1 <b>FR</b> Filets de raccordement métriques M10 x 1 <b>ES</b> Rosca de conexión métrica M10 x 1 <b>HR</b> Metrički spojni navoj M10 x 1 <b>HU</b> Csatlakozómenetek metrikus M10 x 1 <b>RO</b> Filet de conectare metric M10 x 1 <b>BG</b> Метрични рези за свързване M10 x 1
	<b>DE</b> Tiefe 43 mm <b>EN</b> Depth 43 mm <b>FR</b> Profondeur 43 mm <b>ES</b> Profundidad 43 mm <b>HR</b> Dubina 43 mm <b>HU</b> Mélység 43 mm <b>RO</b> Adâncime 43 mm <b>BG</b> 43 мм дълбочина
	<b>DE</b> Aluminium-Kopf <b>EN</b> Aluminium head <b>FR</b> Tête <b>EN</b> aluminium <b>ES</b> Cabezal de aluminio <b>HR</b> Aluminijaska glava <b>HU</b> Alumínium fej <b>RO</b> Cap din aluminiu <b>BG</b> Алюминиев накрайник
	<b>DE</b> Kopf aus Zinkdruckguss <b>EN</b> Die-cast zinc head <b>FR</b> Tête <b>EN</b> zinc moulé sous pression <b>ES</b> Cabeza de fundición de zinc <b>HR</b> Glava od cinkovog odjevka <b>HU</b> Öntött cink fej <b>RO</b> Cap din zinc turnat sub presiune <b>BG</b> Цинков накрайник от леење под налягане
	<b>DE</b> Haupt-Spreizbolzen 127 mm <b>EN</b> Main expansion bolt 127 mm <b>FR</b> Boulon d'écartement principal 127 mm <b>ES</b> Perno de separación principal 127 mm <b>HR</b> Glavni ekspanzivni vijak 127 mm <b>HU</b> Fő széthúzócsavar 127 mm <b>RO</b> Șurub principal de expansiune 127 mm <b>BG</b> Основен разширителен болт 127 мм
	<b>DE</b> Häkchen <b>EN</b> Hooks <b>FR</b> Crochets <b>ES</b> Ganchos <b>HR</b> Kuke <b>HU</b> Horgok <b>RO</b> Cârțig <b>BG</b> Куки
	<b>DE</b> Anzahl der Arme 8 <b>EN</b> Number of arms 8 <b>FR</b> Nombre de bras 8 <b>ES</b> Número de brazos 8 <b>HR</b> Broj krakova 8 <b>HU</b> Karok száma 8 <b>RO</b> Număr de brațe 8 <b>BG</b> Брой рамена 8
	<b>DE</b> Einmaliges Fördervolumen 1,2 cm³ <b>EN</b> One-time flow volume 1,2 cm³ <b>FR</b> Volume de pompage unique de 1,2 cm³ <b>ES</b> Volumen de descarga 1,2 cm³ <b>HR</b> Jednokratni volumen tačenja 1,2 cm³ <b>HU</b> Egyszeri kiürítési térfogat 1,2 cm³ <b>RO</b> Volumul de descărcare unică 1,2 cm³ <b>BG</b> Еднократен обем на щамповане от 1,2 cm³
	<b>DE</b> Einmaliges Fördervolumen 2,4 cm³ <b>EN</b> One-time flow volume 2,4 cm³ <b>FR</b> Volume de pompage unique de 2,4 cm³ <b>ES</b> Volumen de descarga 2,4 cm³ <b>HR</b> Jednokratni volumen tačenja 2,4 cm³ <b>HU</b> Kiürítési térfogat 2,4 cm³ <b>RO</b> Volumul de descărcare unică 2,4 cm³ <b>BG</b> Еднократен обем на щамповане на 2,4 cm³
	<b>DE</b> Einmalige Fördermenge 0,25 l <b>EN</b> One-time flow portion 0,25 l <b>FR</b> Portion de pompage unique 0,25 l <b>ES</b> Porción de prensa-de de 0,25 l cada vez <b>HR</b> Jednokratna porcija tačenja 0,25 l <b>HU</b> Egyszeri kinyomott porció 0,25 l <b>RO</b> Porțiune de descărcare unică de 0,25 l <b>BG</b> Еднократно щамповане от 0,25 л
	<b>DE</b> Einheiten und Messbereich 0 - 80 Meilen <b>EN</b> Units and measurement range 0 - 80 mil <b>FR</b> Unités et plage de mesure 0 - 80 mil <b>ES</b> Unidades y rango de medición 0 - 80 millas <b>HR</b> Jedinice i raspon mjerenja 0 - 80 milja <b>HU</b> Egységék és mérési tartomány 0 - 80 mérföld <b>RO</b> Unități și interval de măsurare 0 - 80 mile <b>BG</b> Единци и обхват на измерване 0 - 80 мили
	<b>DE</b> Einheiten und Messbereich 0-2 mm <b>EN</b> Units and measurement range 0-2 mm <b>FR</b> Unités et plage de mesure 0-2 mm <b>ES</b> Unidades y rango de medición 0-2 mm <b>HR</b> Jedinice i raspon mjerenja 0-2 mm <b>HU</b> Egységék és mérési tartomány 0-2 mm <b>RO</b> Unități și interval de măsurare 0-2 mm <b>BG</b> Единци и обхват на измерване 0-2 мм
	<b>DE</b> Clip x2 <b>EN</b> Clip x2 <b>FR</b> Clip x2 <b>ES</b> Clip x2 <b>HR</b> Isječci x2 <b>HU</b> Gomb x2 <b>RO</b> Agrafă x2 <b>BG</b> Клип x2
	

	<b>DE</b> 4-Backen-Sperrbolzen mit Innengewinde M10 x 1 <b>EN</b> 4-jaw tip with female thread M10 x 1 <b>FR</b> Embout à 4 mâchoires avec filetage femelle M10 x 1 <b>ES</b> Pasador de bloqueo de 4 mordazas con rosca interior M10 x 1 <b>HR</b> Stezni nastavak s 4-čeljusti s unutrašnjim navojem M10 x 1 <b>HU</b> 4-pofajú vég M10 x 1 belső menettel <b>RO</b> Cap cu 4 știfturi de blocare cu filet interior M10 x 1 <b>BG</b> 4 върха на стърга с вътрешна резба M10 x 1

**76 SIZES**  
**DE** Druckfedern 76 Größen **EN** Compression springs 76 sizes **FR** Ressorts de compression 76 tailles **ES** Muelles de compresión 76 tamaños **HR** Vlačice opruge 76 veličina **HU** Nyomórúgó 76 méret **RO** Arcuri de compresie 76 dimensiuni **BG** Компресионни пружини 76 размера

**K-KEJETRONIC SIS**  
**DE** K-KEJETRONIC Einspritzsysteme **EN** K-KEJETRONIC injection systems **FR** Systèmes d'injection K-KEJETRONIC **ES** Sistemas de inyección K-KEJETRONIC **HR** K-KEJETRONIC sustavi ubrizgavanja **HU** K-KEJETRONIC befecskendő rendszerek **RO** Sisteme de injectie K-KEJETRONIC **BG** K-KEJETRONIC инжекционни системи

**KEJETRONIC KIC**  
**DE** KEJETRONIC KIC SIS Einspritzsysteme **EN** KEJETRONIC KIC SIS injection systems **FR** Systèmes d'injection KEJETRONIC KIC SIS **ES** Sistemas de inyección K-KEJETRONIC KIC SIS **HR** KEJETRONIC KIC SIS sustavi ubrizgavanja **HU** KEJETRONIC KIC SIS befecskendő rendszerek **RO** Sisteme de injectie KEJETRONIC KIC SIS **BG** KEJETRONIC KIC SIS инжекционни системи

**LJETRONIC LIW**  
**DE** LJETRONIC LIW Einspritzsysteme **EN** LJETRONIC LIW injection systems **FR** Systèmes d'injection LJETRONIC LIW **ES** LJETRONIC LIW Sistemas de inyección LIW **HR** LJETRONIC LIW sustavi ubrizgavanja **HU** LJETRONIC LIW befecskendő rendszerek **RO** Sisteme de injectie LJETRONIC LIW **BG** LJETRONIC LIW инжекционни системи

**8 mm**  
**DE** Spalt 8 mm **EN** 8 mm gap **FR** Jeu de 8 mm **ES** 8 mm de separación **HR** Razmak od 8 mm **HU** 8 mm hézag **RO** Decalaj de 8 mm **BG** Пролука 8 мм

**35-42 mm**  
**DE** Unterstützer Größenbereich 35 - 42 mm **EN** Range of supported sizes 35 - 42 mm **FR** Gamme de tailles prises **EN** charge 35 - 42 mm **ES** Gama de tamaños 35 - 42 mm **HR** Raspon podržanih veličina 35 - 42 mm **HU** Támogatott mérettartomány 35 - 42 mm **RO** Gama de dimensiuni acceptate 35 - 42 mm **BG** Обхват на поддръжаните размери 35 - 42 mm

**13 mm**  
**DE** Breite der Blätter 13 mm **EN** Flap width 13 mm **FR** Largeur des feuilles 13 mm **ES** Anchura de la hoja 13 mm **HR** Širina listića 13 mm **HU** Lapszélesség 13 mm **RO** Lățimea foilor 13 mm **BG** Ширина на острието 13 мм

**19/22/25/38 mm**  
**DE** Meißelbreiten 19, 22, 25, 38 mm **EN** Chisel widths 19, 22, 25, 38 mm **FR** Largeur du ciseau 19, 22, 25, 38 mm **ES** Anchos de cincel 19, 22, 25, 38 mm **HR** Širina dljetja 19, 22, 25, 38 mm **HU** Vésőszélesség 19, 22, 25, 38 mm **RO** Lățimea daltei 19, 22, 25, 38 mm **BG** Ширина на длето 19, 22, 25, 38 mm

**needle 210 mm**  
**DE** Spieß **EN** Spike **FR** Brochette **ES** Espiga **HR** Iгла s drškom **HU** Nyárs **RO** Ac trasat **BG** Шиш

**WET/GEL/AGM/Ca-Ca**  
**DE** Batterietyp WET, GEL, AGM, Ca-Ca **EN** Battery type WET, GEL, AGM, Ca-Ca **FR** Type de batterie WET, GEL, AGM, Ca-Ca **ES** Tipo de batería WET, GEL, AGM, Ca-Ca **HR** Tip baterije WET, GEL, AGM, Ca-Ca **HU** Akkumulátor típus WET, GEL, AGM, Ca-Ca **RO** Tip de baterie WET, GEL, AGM, Ca-Ca **BG** Тип батерия WET, GEL, AGM, Ca-Ca

**WET**  
**DE** Batterietyp WET **EN** Battery type WET **FR** Type de batterie WET **ES** Tipo de batería WET **HR** Tip baterije WET **HU** Akkumulátor típus WET **RO** Tip de baterie WET **BG** Тип батерия

**AV**  
**DE** AV-Lüftung **EN** AV valve **FR** Évent AV **ES** Ventilador AV **HR** Ventil AV **HU** szelrep **RO** Supapă AV **BG** AV кланан

**17 mm**  
**DE** Ausgang Maulschlüssel 17 mm **EN** Flat wrench outlet 17 mm **FR** Sortie pour la clé plate 17 mm **ES** Llave de salida 17 mm **HR** Izlaz pljosnati ključ od 17 mm **HU** Kímenet lapos kulcs 17 mm **RO** Iesire cheie plată 17 mm **BG** Излезте с плосък ключ 17 мм

**22 mm**  
**DE** Ausgang Maulschlüssel 22 mm **EN** Flat wrench outlet 22 mm **FR** Sortie pour la clé plate 22 mm **ES** Llave de salida 22 mm **HR** Izlaz pljosnati ključ od 22 mm **HU** Kímenet lapos kulcs 22 mm **RO** Iesire cheie plată 22 mm **BG** 22 mm плосък гаечен ключ

**1/2"**  
**DE** Ausgang für 1,2 Zoll Quadrat **EN** Square outlet 1,2 inch **FR** Sortie pour un carré de 1,2 pouce **ES** Salida para cuadrado de 1,2 pulgadas **HR** Kvadratni izlaz 1,2 inča **HU** 1,2 hüvelyk négyzet kímenet **RO** Iesire pătrată 1,2 inch **BG** 1,2 инчов квадратен изход

**3/8"**  
**DE** Ausgang für 3,8 Zoll Quadrat **EN** Square outlet 3,8 inch **FR** Sortie pour un carré de 3,8 pouce **ES** Salida cuadrada de 3,8 pulgadas **HR** Kvadratni izlaz 3,8 inča **HU** 3,8 hüvelyk négyzet kímenet **RO** Iesire pătrată 3,8 inch **BG** 3,8 инчов квадратен изход

**LED DISPLAY**  
**DE** LED-Anzeige **EN** LED display **FR** Affichage LED **ES** Pantalla LED **HR** LED zaslon **HU** LED kijelző **RO** Afisaj LED **BG** LED дисплей

**300mm**  
**DE** Schlauch 300 mm **EN** 300 mm hose **FR** Tuyau 300 mm **ES** Manguera 300 mm **HR** Crijeva 300 mm **HU** Tömlő 300 mm **RO** Furtun 300 mm **BG** 300 mm маркуч

**280mm**  
**DE** Nadelschlauch 280 mm **EN** Igelit hose 280 mm **FR** Tuyau **EN** plastique 280 mm **ES** Manguera de agujas 280 mm **HR** Plastično crijevo 280 mm **HU** Műanyag tömlő 280 mm **RO** Furtun cu ac 280 mm **BG** 280 mm Пластмасова тръба

**10-180 mm**  
**DE** Arbeitsbereich 10 - 180 mm **EN** Operating range 10-180 mm **FR** Plages de travail 10 - 180 mm **ES** Rango de trabajo 10-180 mm **HR** Radni raspon 10-180 mm **HU** Munkatartomány 10-180 mm **RO** Intervalul de lucru 10-180 mm **BG** Работен диапазон 10-180 мм

**305 mm**  
**DE** Arbeitsbereich 305 mm; **EN** Operating range 305 mm **FR** Plages de travail 305 mm **ES** Rango de trabajo 305 mm **HR** Radni raspon 305 mm **HU** Munkatartomány 305 mm **RO** Intervalul de lucru 305 mm **BG** Работен диапазон 305 мм

**355 mm**  
**DE** Arbeitsbereich 355 mm; **EN** Operating range 355 mm **FR** Plages de travail 355 mm **ES** Rango de trabajo 355 mm **HR** Radni raspon 355 mm **HU** Munkatartomány 355 mm **RO** Intervalul de lucru 355 mm **BG** Работен диапазон 355 мм

**18-54 mm**  
**DE** Arbeitsbereich der Spitze 18 - 54 mm; **EN** Operating range of the tip 18-54 mm **FR** Plage de travail de l'embout 18-54 mm **ES** Rango de trabajo de la punta 18-54 mm **HR** Radni raspon nastavka 18-54 mm **HU** A hegy munkatartománya 18-54 mm **RO** Intervalul de lucru al vârfului 18-54 mm **BG** Работният диапазон на върха 18-54 мм

**0-125°C**  
**DE** Temperaturbereich -50 bis 125°C **EN** Temperature range -50 to 125°C **FR** Plage de température de -50 à 125°C **ES** Rango de temperatura -50 a 125°C **HR** Raspon temperatura -50 do 125°C **HU** Hőmérséklet-tartomány -50 és 125°C között **RO** Interval de temperatură -50 până la 125°C **BG** Температурен диапазон -50 до 125 °C

**30,5 mm**  
**DE** Innendurchmesser 30,5 mm **EN** Inner diameter 30,5 mm **FR** Diamètre intérieur 30,5 mm **ES** Diámetro interior 30,5 mm **HR** Unutarnji promjer 30,5 mm **HU** Belső átmérő 30,5 mm **RO** Diametru intern 30,5 mm **BG** Вътрешен диаметър 30,5 мм

**32,5 mm**  
**DE** Innendurchmesser 32,5 mm **EN** Outer diameter 32,5 mm **FR** Diamètre intérieur 32,5 mm **ES** Diámetro interior 32,5 mm **HR** Unutarnji promjer 32,5 mm **HU** Belső átmérő 32,5 mm **RO** Diametru intern 32,5 mm **BG** Вътрешен диаметър 32,5 мм

**ø8 mm**  
**DE** Schlauchdurchmesser 8 mm **EN** Hose diameter 8 mm **FR** Diamètre du tuyau 8 mm **ES** Diámetro de la manguera 8 mm **HR** Promjer crijeva 8 mm **HU** Tömlő átmérő 8 mm **RO** Diametru furtunului 8 mm **BG** Диаметър на тръбата 8 мм

**30-35 mm 35-40 mm 40-45 mm**  
**DE** Stangendurchmesser 30-35mm 35-40mm 40-45mm **EN** Bar diameters 30-35mm 35-40mm 40-45mm **FR** Diamètres des tiges 30-35mm 35-40mm 40-45mm **ES** Diámetros de varilla 30-35mm 35-40mm 40-45mm **HR** Promjer drške 30-35mm 35-40mm 40-45mm **HU** Rúdátmérők 30-35mm 35-40mm 40-45mm **RO** Diametru tijelor 30-35mm 35-40mm 40-45mm **BG** Диаметри на пръта 30-35mm 35-40mm 40-45mm

**AUTO LOCK**  
**DE** Automatische Verriegelung **EN** Automatic lock **FR** Verrouillage automatique **ES** Bloqueo automático **HR** Automatsko zaključavanje **HU** Automatikus blokkolás **RO** Blocare automată **BG** Автоматично заключване

**BX4 Cut**  
**DE** 4-Schneider-Bohrer **EN** 4-blade drill bit **FR** Foret à 4 tranchants **ES** Broca de cuatro cortes **HR** Svrdlo s 4 oštrice **HU** 4 éltű fűró **RO** Burghiu cu 4 tășuri **BG** Свредло с 4 остриета

**120mm**  
**DE** Bohrerlänge 120 mm **EN** Drill length 120 **FR** Longueur du foret 120 **ES** Longitud de la broca 120 **HR** Duljina svrdla 120 **HU** Fűrófej hosszúság 120 **RO** Lungime burghiu 120 **BG** Дължина на свредлото 120

**130mm**  
**DE** Bohrerlänge 130 mm **EN** Drill length 130 **FR** Longueur du foret 130 **ES** Longitud de la broca 130 **HR** Duljina svrdla 130 **HU** Fűrófej hosszúság 130 **RO** Lungime burghiu 130 **BG** Дължина на свредлото 130

**50 mm**  
**DE** Lochsägetiefe 50 mm **EN** Keyhole depth 50 mm **FR** Profondeur de la scie cloche 50 mm **ES** Profundidad de la sierra 50 mm **HR** Dubina krune za bušenje otvora 50 mm **HU** Lyukfűrészmélység 50 mm **RO** Adâncimea ferăstrăului de găurit 50 mm **BG** 50 мм дълбочина на триона

**38 mm**  
**DE** Bohrtiefe 38 mm **EN** Drilling depth 38 mm **FR** Profondeur de perçage 38 mm **ES** Profundidad de perforación 38 mm **HR** Dubina bušenja 38 mm **HU** Fúrás mélység 38 mm **RO** Adâncimea de găurire 38 mm **BG** Дълбочина на пробиване 38 мм

**7/16"**  
**DE** HEX 7,16 Zoll **EN** HEX 7,16 inch **FR** HEX 7,16 pouce **ES** HEX 7,16 pulgadas **HR** HEX 7,16 kal **HU** HEX 7,16 hüvelyk **RO** HEX 7,16 inch **BG** HEX 7,16 инча

**x4**  
**DE** Anzahl der Klingen x4 **EN** Number of blades x4 **FR** Nombre de lames x4 **ES** Número de cuchillas x4 **HR** Broj oštrice x4 **HU** Élek száma x4 **RO** Număr de lame x4 **BG** Брой остриета x4

**10 TPI**  
**DE** Anzahl der Zähne 10 TPI **EN** Number of teeth 10 TPI **FR** Nombre de dents 10 TPI **ES** Número de dientes 10 TPI **HR** Broj zuba 10 TPI **HU** Fogak száma 10 TPI **RO** Număr de dinți 10 TPI **BG** Брой зъби 10 TPI

**teeth shape**  
**DE** Zahnform gefräst variabel **EN** Tooth shape milled variable **FR** Forme des dents fraisées variables **ES** Forma del diente fresado variable **HR** Oblik zuba glodani promjenjivi **HU** A fog alakja változó marású **RO** Forma dinților frezați, variabilă **BG** Формата на фрезованите зъби, променлива

**teeth shape**  
**DE** Zahnform geschliffen offen **EN** Tooth shape ground open **FR** Forme des dents meulées ouvertes **ES** Forma de los dientes rectificadas **HR** Oblik zuba brušeni tupi **HU** A fogak alakja csiszolt nyitott **RO** Forma dinților șlefuită, obtuză **BG** Формата на зъбите е силна, отворени

**teeth shape**  
**DE** Zahnform geschliffen konvergent **EN** Tooth shape ground convergent **FR** Forme des dents meulées convergentes **ES** Forma de los dientes convergentes molidos **HR** Oblik zuba brušeni konvergentni **HU** A fogak alakja csiszolt konvergens **RO** Forma dinților șlefuită, convergentă **BG** Формата на зъбите е шлифована, конвергентна

**LASER CUTTING BLADE**  
**DE** Laser-geschliffene Klinge **EN** Laser sharpened blade **FR** Lame affûtée au laser **ES** Cuchilla afilada por láser **HR** Laserski naoštrena oštrica **HU** Lézerrel élezett penge **RO** Lamă ascuțită cu laser **BG** Лазерно заточено острие

**HCS 65Mn**  
**DE** Werkstoff HCS 65Mn **EN** Material HCS 65Mn **FR** Matériau HCS 65Mn **ES** Material HCS 65Mn **HR** HCS 65Mn materijal **HU** Anyag HCS 65Mn **RO** Material HCS 65Mn **BG** HCS 65Mn материал

**HSS**  
**DE** HSS-Material **EN** Material HSS **FR** Matériau HSS **ES** Material HSS **HR** Materijal HSS **HU** Anyag HSS **RO** Material HSS **BG** HSS материал

**ABS + TPR**  
**DE** ABS + TPR Gehäuse-Material **EN** Body material ABS + TPR **FR** Matériau du corps ABS + TPR **ES** Material del cuerpo ABS + TPR **HR** Materijal tijela ABS TPR **HU** Ház anyag ABS + TPR **RO** Material corp ABS + TPR **BG** Материал на корпуса ABS + TPR

**ABS**  
**DE** ABS-Gehäusmaterial **EN** Body material ABS **FR** Matériau du corps ABS **ES** Material del cuerpo ABS **HR** Materijal tijela ABS **HU** Ház anyag ABS **RO** Material corp ABS **BG** Материал на корпуса от ABS

**ALU + ABS**  
**DE** ALU + ABS Gehäuse-Material **EN** Body material ALU + ABS **FR** Matériau du corps ALU + ABS **ES** Material de la carcasa ALU + ABS **HR** Materijal tijela ALU ABS **HU** Ház anyag ALU + ABS **RO** Material corp ALU + ABS **BG** Материал на корпуса ALU + ABS

**ALU + TPR**  
**DE** ALU + TPR Gehäuse-Material **EN** Body material ALU + TPR **FR** Matériau du corps ALU + TPR **ES** Material del cuerpo ALU + TPR **HR** Materijal tijela ALU TPR **HU** Ház anyag ALU + TPR **RO** Material corp ALU + TPR **BG** Материал на корпуса ALU + TPR

**ALU**  
**DE** ALU-Gehäusmaterial **EN** Body material ALU **FR** Matériau du corps ALU **ES** Material de la carcasa ALU **HR** Materijal tijela ALU **HU** Ház anyag ALU **RO** Material corp ALU **BG** Материал на корпуса ALU

**PS + TPR**  
**DE** PS + TPR Gehäuse-Material **EN** Body material PS + TPR **FR** Matériau du corps PS + TPR **ES** Material del cuerpo PS + TPR **HR** Materijal tijela PS TPR **HU** Ház anyag PS + TPR **RO** Material corp PS + TPR **BG** Материал на корпуса PS + TPR

**SK2H**  
**DE** Material der Klinge SK2H **EN** Blade material SK2H **FR** Matériau de la lame SK2H **ES** Material de la hoja SK2H **HR** Materijal oštrice SK2H **EN** Penge anyag SK2H **RO** Material lamă SK2H **BG** Материал на острието SK2H

**SK5**  
**DE** Material der Klinge SK5 **EN** Blade material SK5 **FR** Matériau de la lame SK5 **ES** Material de la hoja SK5 **HR** Materijal oštrice SK5 **HU** Penge anyag SK5 **RO** Material lamă SK5 **BG** Материал на острието SK5

**METAL GUIDE BAR**  
**DE** Führungsschienenmaterial Metall **EN** Guide bar material metal **FR** Matériau du guidage : métal **ES** Material de la guía metal **HR** Materijal vodilice metal **HU** Vezetősín anyag **RO** Material ghidaj - metal **BG** Метален направляващ материал

**MAX 12 500 RPM**  
**DE** Max. Drehzahl 12 500 U/min **EN** Max. 12 500 RPM **FR** Vitesse max 4500 RPM **ES** Velocidad máxima 12 500 RPM **HR** Maksimalni broj okretaja 12 500 RPM **HU** Maximális fordulatszám 12 500 RPM **RO** Viteza maximă 12 500 RPM **BG** Максимални обороти 12 500 RPM

**MAX 4500 RPM**  
**DE** Max. Drehzahl 4 500 U/min **EN** Max. 4500 RPM **FR** Vitesse max 4500 RPM **ES** Velocidad máxima 4500 RPM **HR** Maksimalni broj okretaja 4500 RPM **HU** Maximális fordulatszám 4500 RPM **RO** Viteza maximă 4500 RPM **BG** Максимални обороти 4500 RPM

**MAX 8500 RPM**  
**DE** Max. Drehzahl 8 500 U/min **EN** Max. 8500 RPM **FR** Vitesse max 8500 RPM **ES** Velocidad máxima 8500 RPM **HR** Maksimalni broj okretaja 8500 RPM **HU** Maximális fordulatszám 8500 RPM **RO** Viteza maximă 8500 RPM **BG** Максимални обороти 8500 RPM

**BELT CUT**  
**DE** Gurt-Seitenschneider **EN** Side belt cutter **FR** Coupe-ceinture latérale **ES** Cortadora de cinta lateral **HR** Bočni rezač remena **HU** Szalagvágó oldalsó olló **RO** Cuțit de tăiat lateral bandă **BG** Фреза за страничен колан

**ANTHRUST BLADE**  
**DE** Korrosionsschutz Klinge **EN** Anti-corrosion blade **FR** Lame anti-corrosive **ES** Hoja anticorrosiva **HR** Antikorozivna oštrica **HU** Korrozóálló penge **RO** Lamă anticorozivă **BG** Антикорозионно острие

**CAN OPENER**  
**DE** Dosenöffner **EN** Can opener **FR** Ouvre-boîtes **ES** Abretas **HR** Otvarač limenki **HU** Konzervnyitó **RO** Deschizător de cutii metalice **BG** Отварачка за консерви

**PLASTIC**  
**DE** Kunststoff Klinge **EN** Plastic saw blade **FR** Lame **EN** plastique **ES** Hoja de plástico **HR** Plastini list pile **HU** Műanyag penge **RO** Pânză de ferăstrău din plastic **BG** Пластмасов трион

**MULTI STOP**  
**DE** Positionen der Klinge **EN** Blade positions **FR** Positions de la lame **ES** Posiciones de las cuchillas **HR** Položaji oštrice **HU** Penge pozíciók **RO** Poziții ale lamei **BG** Позиции на острието

**LOCK-BUTTON**  
**DE** Sperrtaste **EN** Locking button **FR** Bouton de verrouillage **ES** Botón de bloqueo **HR** Gumb za zaključavanje **HU** Blokkoló gomb **RO** Buton de blocare **BG** Бутон за заключване

**XTRME SHARP EDGE**  
**DE** Klinge Typ XSE **EN** Blade type XSE **FR** Type de lame XSE **ES** Cuchilla tipo XSE **HR** Tip oštrice XSE **HU** Penge típus XSE **RO** Tipul de lamă XSE **BG** Острие тип XSE

**FOLDABLE**  
**DE** Zusammenklappbar **EN** Folded **FR** Pliable **ES** Plegable **HR** Sklopivi **HU** Összecsukható **RO** Pliatibilă **BG** Съгъване

**M16**  
**DE** Halterung M16 **EN** Handle M16 **FR** Support M16 **ES** M16 mango **HR** Držač M16 **HU** Tokmány M16 **RO** Suport M16 **BG** Държач M16

**DE** Zylindrisches Spannfutter mit Fase **EN** Cylindrical handle with chamfer **FR** Poignée cylindrique avec chanfrein **ES** Mandril cilíndrico con chafán **HR** Upuštač **HU** Hengeres tokmány fázisolt **RO** Suport cilindric cu șanfrean **BG** Цилиндрична дръжка с фаска

**T-type**  
**DE** T-Griff **EN** Handle type T **FR** Poignée **EN** T **ES** Mango **EN** T **HR** T-ručka **HU** T-fogantyú; **RO** Suport de tip T **BG** T-дръжка

**SL**  
**DE** Schraubendreher **SL** **EN** Screwdriver **SL** **FR** Tournevis **SL** **ES** Destornillador **SL** **HR** SL odvijač **HU** SL csavarhúzó **RO** Șurubelniță **SL** **BG** SL отвертка

**EASY CHANGE**  
**DE** Klingwechsel - einfach **EN** Blade replacement - easy **FR** Remplacement de la lame - facile **ES** Sustitución de la cuchilla - fácil **HR** Zamjena oštrice - jednostavna **HU** Pengecseré - egyszerű **RO** Încuirea lamei - ușoră **BG** Смяна на острието - лесно

**VHM**  
**DE** Hartmetall **EN** Sintered carbide **FR** Carbone cémenté **ES** Carburo **HR** Sintetirani karbid **HU** Karbid **RO** Carbură **BG** Волфрамов карбид печен

**20 KG FULLFORCE RESISTANCE**  
**DE** Klingenauswurfschutz 20 kg **EN** Protection against blade ejection 20 kg **FR** Protection contre l'éjection de la lame 20 kg **ES** Protección contra la expulsión de la hoja 20 kg **HR** Zaštita od izbacivanja oštrice 20 kg **HU** Pengekidobás elleni védelem 20 kg **RO** Protecție împotriva ejectării lamei 20 kg **BG** Защита срещу изхвърляне на острието 20 кг

**60 KG FULLFORCE RESISTANCE**  
**DE** Klingenauswurfschutz 60 kg **EN** Protection against blade ejection 60 kg **FR** Protection contre l'éjection de la lame 60 kg **ES** Protección contra la expulsión de la hoja 60 kg **HR** Zaštita od izbacivanja oštrice 60 kg **HU** Pengekidobás elleni védelem 60 kg **RO** Protecție împotriva ejectării lamei 60 kg **BG** Защита срещу изхвърляне на острието 60 кг

**DE** Siebfänger innen **EN** Mesh inside **FR** Tamis à l'intérieur **ES** Tamiz interior **HR** Sito unutra **HU** Szita belül **RO** Sita în interior **BG** Цедка отвътре

**DE** Adapter für Steckschlüssel und Schraubendrehereinsätze **EN** Adapter for sockets and screwdriver tips **FR** Adaptateur pour douilles et embouts de tournevis **ES** Adaptador para llaves de vaso y puntas de destornillador **HR** Adapter za nastavke i vrhove za odvijanje **HU** Adapter dugókulcsokhoz és csavarhúzó bitekhez **RO** Adaptor pentru prize și biți de șurubelniță **BG** Адаптор за вложки, бормашина

**DE** Klettverschluss **EN** Velcro **FR** Velcro **ES** Velcro **HR** Čičak **HU** Tépőzár **RO** Scal **BG** Велкро лента

**BELT HANGER**  
**DE** Gürtelclip **EN** Belt clip **FR** Clip de ceinture **ES** Clip para el cinturón **HR** Kopča za remen **HU** Övcsipesz **RO** Clemă pentru curea **BG** Шпика за колан

**1x140 mm**  
**DE** 1 Schublade Höhe 140 mm **EN** 1 drawer 140 mm high **FR** 1 tiroir hauteur de 140 mm **ES** 1 cajón altura 140 mm **HR** 1 ladica visine 140 mm **HU** 1 db 140 mm magas fiók **RO** 1 sertar înălțime 140 mm **BG** Височина на 1 чекмедже 140 мм

**2 modules**  
**DE** 2 Module **EN** 2 modules **FR** 2 modules **ES** 2 módulos **HR** 2 modula **HU** 2 modul **RO** 2 module **BG** 2 модула

**AUTO LOCK**  
**DE** Selbstnivellierendes Schloss **EN** Self-leveling lock **FR** Verrouillage d'autonivellement **ES** Cerradura autonivelante **HR** Blokada samonivelirajuća **EN** Önszintezés blokk **RO** Blocaj cu auto-nivelare **BG** Блокпировака самонивелираща

**max 10 h**  
**DE** Arbeitszeit 10h **EN** Working time 10h **FR** Temps de travail 10h **ES** Tiempo de funcionamiento 10h **HR** Vrijeme rada 10h **HU** Működési idő 10h **RO** Timp de lucru 10h **BG** Работно време 10h

**±0,3 mm/m**  
**DE** Genauigkeit 0,3 mm/m **EN** Accuracy 0,3 mm/m **FR** Précision 0,3 mm/m **ES** Precisión 0,3 mm/m **HR** Preciznost 0,3 mm/m **HU** Pontosság 0,3 mm/m **RO** Precizie 0,3 mm/m **BG** Точност 0,3 mm/m

**WOODEN WORKTOP 10 mm**  
**DE** Arbeitsplatte aus Holz mit 10 mm Dicke **EN** Wooden worktop 10 mm thick **FR** Plan de travail en bois de 10 mm d'épaisseur **ES** Encimera de madera de 10 mm de grosor **HR** Drvena radna ploha debljine 10 mm **HU** 10 mm vastag fa munkalap **RO** Blat de lucru din lemn, grosime 10 mm **BG** Дървен работен плот с дебелина 10 мм

**505-520 Nm**  
**DE** Wellenlänge 505-520 Nm **EN** Wavelength 505-520 Nm **FR** Longueur d'onde 505-520 Nm **ES** Longitud de onda 505-520 Nm **HR** Valne duljine 505-520 Nm **HU** Hullámhossz 505-520 Nm **RO** Lungime de undă 505-520 Nm **BG** Дължина на вълната 505-520 Nm

**FLEXIBLE HEAD**  
**DE** Flexibles Gelenk **EN** Flexible head **FR** Joint flexible **ES** Junta flexible **HR** Fleksibilan zglob **HU** Rugalmas csukló **RO** Articulație flexibilă **BG** Гъвкаво съединение

**THICKNESS 1,0 mm**  
**DE** Dicke des Metallprofils 1 mm **EN** Thickness of metal profiles - 1mm **FR** Épaisseur de profils métalliques 1 mm **ES** Espesor del perfil metálico 1 mm **HR** Debljina metalnih profila 1 mm **HU** A fémf profilok vastagsága 1 mm **RO** Grosime profiluri din metal 1 mm **BG** Дебелина на металния профил 1 mm

**20**  
**DE** Anzahl der Drähte 20 **EN** Wire quantity 20 **FR** Quantité de fil 20 **ES** Cantidad de alambre 20 **HR** Količina žice 20 **HU** Drótok száma 20 **RO** Cantitate de sârmă 20 **BG** Брой жици 20

**GREEN LASER**  
**DE** Grünes Laserlicht **EN** Green laser light **FR** Lumière laser verte **ES** Luz láser verde **HR** Zeleno svjetlo lasera **HU** Zöld lézertényő **RO** Lumină laser verde **BG** Зелена лазерна светлина

**RED LASER**  
**DE** Rotes Laserlicht **EN** Red laser light **FR** Lumière laser rouge **ES** Luz láser rojo **HR** Crveno svjetlo lasera **HU** Vörös lézertényő **RO** Lumină laser roșie **BG**

**REINFORCED WALL STRUCTURE**  
**DE** Verstärkte Wandkonstruktion **EN** Reinforced wall structure **FR** Construction de murs renforcés **ES** Construcción de paredes reforzadas **HR** Pojačana konstrukcija zidova **HU** Megerősített falszerkezet **RO** Construcție de pereți ranforsată **BG** Конструкция на подсилена стена

**DE** Innerer Absetzring **EN** Inner Seeger ring **FR** Bague intérieure **ES** Anillo interior **HR** Unutarnji sigurnosni prsten **HU** Belső rögzítőgyűrű **RO** Inel interior **BG** Външен фиксиращ пръстен

**DE** Äußerer Absetzring **EN** Outer Seeger ring **FR** Bague extérieure **ES** Anillo exterior **HR** Unutarnji sigurnosni prsten **HU** Belső rögzítőgyűrű **RO** Inel exterior **BG** Външен фиксиращ пръстен

**DE** Adapter für Schraubendreherbits 1/4" x19 mm **EN** 1/4" x19 mm screwdriver bits adapters **FR** Adaptateurs pour embouts de tournevis 1/4" x 19 mm **ES** Adaptador para puntas de destornillador 1/4" x19 mm **HR** Adapter za bitove 1/4" x19 mm **HU** Bithegy tartó adapter 1/4" x 19 mm **BG** Адаптор за битове 1/4" x 19 mm **RO** Adapter pentru biți de șurubelniță de 1/4" x19 mm **BG** 1/4" x 19 mm адаптери за отвертки

**DE** Adapter für Aufsätze 1/2" x 19 mm **EN** 1/2" x 19 mm sockets adapters **FR** Adaptateur pour douille 1/2" x 19 mm **ES** Adaptador para toma de corriente de 1/2" x 19 mm **HR** Adapter za nastavke 1/2" x 19 mm **HU** Adapter 1/2" x 19 mm-es aljzathoz **RO** Adaptor pentru biți 1/2" x 19 mm **BG** Адаптер за гнездо 1/2" x 19 mm

**DE** Batterien 4xLR44 **EN** 4xLR44 batteries **FR** Batteries 4xLR44 **ES** Pilas 4xLR44 **HR** Baterije 4xLR44 **HU** 4xLR44 elemek **RO** Baterii 4xLR44 **BG** Батерии 4xLR44

**DE** Hebel mit Führungszahnung. **EN** Lever with guide pinion. **FR** Levier avec pignon de guidage **ES** Palanca con piñón guía. **HR** Poluga s vodećom zupčastom letvom **HU** Kar fogas vezetőléccel. **RO** Pârghie cu pinion de ghidare. **BG** Лост с направляваща зъбна предавка.

**DE** Schnelles Schneiden **EN** Fast cutting **FR** Coupe rapide **ES** Corte rápido **HR** Brzo rezanje **HU** Gyors vágás **RO** Taiere rapidă **BG** Бързо рязане

**DE** Hohe Präzision **EN** High precision **FR** Haute précision **ES** Alta precisión **HR** Visoka preciznost **HU** Magas precízió **RO** Precizie ridicată **BG** Висока прецизност

**DE** Zähne pro Zoll 7 TPI **EN** Number of teeth per inch 7 TPI **FR** Nombre de dents pas pouce 7 TPI **ES** Número de dientes por pulgada 7 TPI **HR** Količina zubi po inču 7 TPI **HU** A fogak hüvelyenkénti száma 7 TPI **RO** numărul de dinți pe inch 7 TPI; **BG** брой зъби на инч 7 TPI

**DE** Schnittrichtung längs und umlaufend **EN** Cutting direction along and around the circumference **FR** Direction de coupe le long et sur la circonférence **ES** Dirección de corte a lo largo y alrededor de la circunferencia **HR** Smjer rezanja duž dužine i opešaga **HU** Vágási irány hosszában és a kerület mentén **RO** Direcția de tăiere de-a lungul și în jurul circumferinței **BG** Поскока на рязане по периферията и около нея

**DE** Farbe der Kreide - blau **EN** Chalk colour - blue **FR** Couleur de la craie - bleu **ES** Color de la tiza - azul **HR** Boja krede - plava **HU** Kréta színe - kék **RO** Culoarea cretei - albastru **BG** Цвет на кредата - син

**DE** Schnittwinkel 0\_30\_45 Grad **EN** Cutting angle 0\_30\_45 degrees **FR** Angle de coupe 0\_30\_45 degrés **ES** Ángulo de corte 0\_30\_45 grados **HR** Kut rezanja 0\_30\_45 stupnjeva **HU** Vágási szög 0\_30\_45 fok **RO** Unghi de tăiere 0\_30\_45 grade **BG** Ъгъл на рязане 0\_30\_45 градуса

**DE** Backenwinkel 0 Grad **EN** Jaw angle 0 degrees **FR** Angle de la mâchoire 0 degré **ES** Ángulo de apriete 0 grados **HR** Kut četjusti 0 stupnjeva **HU** Pofaszög 0 fok **RO** Unghiul fălcilor 0 grade **BG** Ъгъл на челюстта 0 градуса

**DE** Backenwinkel 45 Grad **EN** Jaw angle 45 degrees **FR** Angle de la mâchoire 45 degrés **ES** Ángulo de apriete 45 grados **HR** Kut četjusti 45 stupnjeva **HU** Pofaszög 45 fok **RO** Unghiul fălcilor 45 grade **BG** Ъгъл на челюстите 45 градуса

**DE** Backenwinkel 90 Grad **EN** Jaw angle 90 degrees **FR** Angle de la mâchoire 90 degrés **ES** Ángulo de apriete 90 grados **HR** Kut četjusti 90 stupnjeva **HU** Pofaszög 90 fok **RO** Unghiul fălcilor 90 grade **BG** Ъгъл на челюстите 90 градуса

**DE** Schnittwinkel 45 90 135 Grad **EN** Cutting angles 45 90 135 degrees **FR** Angle de coupe 45 90 135 degrés **ES** Ángulos de corte 45 90 135 grados **HR** Kutovi rezanja 45 90 135 stupnjeva **HU** Vágási szögek 45 90 135 fok **RO** Unghiuri de tăiere 45 90 135 grade **BG** Ъгли на рязане 45 90 135 градуса

**DE** Werkstoff Schneidnorm #45 **EN** Cutting shank material #45 **FR** Matériau du boulon de coupe #45 **ES** Material del mango de corte #45 **HR** Materijal reznog trna # 45 **HU** Vágószár anyaga #45 **RO** Material de tăiere a tijei #45 **BG** Материал на дръжката за рязане #45

**MAX 80 kg**  
**DE** MAX Tragkraft 80 kg **EN** MAX load capacity 80 kg **FR** Capacité de charge MAX 80 kg **ES** Capacidad de carga MAX 80 kg **HR** Maksimalna nosivost 80 kg **HU** MAX terhelhetőség 80 kg **RO** Capacitate maximă de încărcare 80 kg **BG** Максимален капацитет на натоварване 80 kg

**MAX 30 kg**  
**DE** Max. Belastung 30 kg **EN** Maximum load 30 kg **FR** Charge max. 30 kg **ES** Carga máxima 30 kg **HR** Maksimalno opterećenje 30 kg **HU** Max. terhelés 30 kg **RO** Sarcină maximă 30kg **BG** Максимално натоварване 30 kg

**MOLLY**  
**DE** Spreizdübel Typ Molly **EN** Molly expansion bolt **FR** Cheville mural type Molly **ES** Perno de expansión tipo Molly **HR** Ekspanzijski čep tipa Molly **HU** Molly típusú fémtipró **RO** Bolț de expansiune Molly **BG** Разширителен болт от типа Molly

**CUTTER**  
**DE** Kabelabschneider **EN** Cable cutter **FR** Coupe-câbles **ES** Cortador de cables **HR** Rezač kabela **HU** Kábelvágó **RO** Cutter de cablu **BG** Резец за кабели

**CUTTER**  
**DE** Kabelbinderschneider **EN** Tie cutter **FR** Coupe-bandes **ES** Cortador de bridas **HR** Rezač kabela **HU** Kötegelővágó **RO** Cutter de coliere **BG** Резец за врътоверзки

**CUTTER**  
**DE** Kabelabschneider **EN** Wire cutter **FR** Coupe-fils **ES** Cortador de tubos **HR** Rezač žica **HU** Vezetékvágó **RO** Cutter de cabluri **BG** Резец за тел

**M 2,5-6,0**  
**DE** Schraubschraubenabschneider M2,5-6,0 **EN** Screw cutter M2,5-6,0 **FR** Coupe-vis M2,5-6,0 **ES** Cortador de tornillos M2,5-6,0 **HR** Rezač vijaka M2,5-6,0 **HU** M2,5-6,0 csavarvágó **RO** Cutter de șuruburi M2,5-6,0 **BG** Резец за винтове M2,5-6,0

**CUTTER**  
**DE** Abschneider **EN** Cutter **FR** Coupe **ES** Cortador **HR** Rezač **HU** Vágó **RO** Cutter **BG** Резец

**CUTTER**  
**DE** Schwenkbare Backen **EN** Rotatable jaws **FR** Mâchoires rotatives **ES** Mordazas giratorias **HR** Rotacijska četjusti **HU** Forgatható pófák **RO** Fălci rotative **BG** Въртящи се челюсти

**BOTH END**  
**DE** Drehbare Klinge **EN** Rotating blade **FR** Lame pivotante **ES** Cuchilla giratoria **HR** Rotacijska oštrica **HU** Forgó penge **RO** Lamă rotativă **BG** Въртящо се острие

**REPLACEABLE BLADE**  
**DE** Wechsell Klinge **EN** Replacement blade **FR** Lame de rechange **ES** Cuchilla reemplazable **HR** Zamjenjiva oštrica **HU** Cserelendő penge **RO** Lamă schimbabilă **BG** Острие за смяна

**REPLACEABLE BLADE**  
**DE** Wechsell Klinge **EN** Replacement blade **FR** Lame de rechange **ES** Cuchilla reemplazable **HR** Zamjenjiva oštrica **HU** Cserelendő penge **RO** Lamă schimbabilă **BG** Острие за смяна

**DE** Aufnahmebohrung 22,23 mm **EN** 22,23 mm fixing hole **FR** Trou de fixation - 22,23 mm **ES** Agujero de fijación 22,23 mm **HR** Otvor za pričvršćivanje 22,23 mm **HU** Rögzítő furat 22,23 mm **RO** Orificiu de fixare 22,23 mm **BG** Отвор за закрепване 22,23 mm

**DE** Passend für Führungsschienen **EN** Suitable for guide rails **FR** Convient aux rails de guidage **ES** Adecuado para carriles guía **HR** Uklapa se s vodilicama **HU** Passzol a vezetősínekhez **RO** Potrivit pentru șine de ghidare **BG** Подходящ за направляващи релси

**FLAT**  
**DE** Schneidprofil - flach **EN** Blade profile - flat **FR** Profil de la lame - plat **ES** Perfil de la hoja - plano **HR** Profil oštrica - plosnati **HU** Penge profil - lapos **RO** Profilul lamei - plat **BG** Профил на острието - плосък

**FOR HT1P603**  
**DE** Geeignet für HT1P603 **EN** Designed for HT1P603 **FR** Conçu pour le HT1P603 **ES** Destinado a HT1P603 **HR** Namijenjen za HT1P603 **HU** HT1P603-hoz alkalmazható **RO** Proiectat pentru HT1P603 **BG** Проектиран за HT1P603

**CRIMPING FORCE ADJUSTMENT**  
**DE** Einstellung der Klemmkraft **EN** Clamping force adjustment **FR** Réglage de la force de sertissage **ES** Ajuste de la fuerza de engaste **HR** Podešavanje sile stiskanja **HU** Krimpelőerő beállítás **RO** Reglarea forței de strângere **BG** Регулиране на силата на затягане

**LENGTH STOP**  
**DE** Einstellung der Kabellänge **EN** Cable length adjustment **FR** Réglage de la longueur du câble **ES** Ajuste de la longitud del cable **HR** Podešavanje dužine kabla **HU** Kábelhossz beállítás **RO** Reglarea lungimii cablului **BG** Регулиране на дължината на кабела

**FORCE ADJUSTMENT**  
**DE** Einstellung der Presskraft **EN** Clamping force adjustment **FR** Réglage de la force de sertissage **ES** Ajuste de la fuerza de sujeción **HR** Podešavanje sile pritiska **HU** Szorítóerő beállítás **RO** Reglarea forței de apăsare **BG** Регулиране на силата на затягане

**Cu, Al, PCV**  
**DE** Art der Leitungen Cu, Al, PVC **EN** Conductor type Cu, Al, PVC **FR** Type de conducteurs Cu, Al, PVC **ES** Tipo de conductor Cu, Al, PVC **HR** Vrsta žica Cu, Al, PCV **HU** Cu, Al, PVC típusú vezeték **RO** Tipul cablului Cu, Al, PVC **BG** Вид на проводника Cu, Al, PVC

**HRC 28-32**  
**DE** Stahlsorten - HRC28-32 **EN** Type of steel - HRC28-32 **FR** Type d'acier - HRC28-32 **ES** Tipo de acero - HRC28-32 **HR** Vrsta čelika - HRC28-32 **ES** Acél típus - HRC28-32 **RO** Tipul de oțel - HRC28-32 **BG** Вид стомана - HRC28-32

**HEX 6/10/16 25/35/50 mm²**  
**DE** Backenart HEX 6\_10\_16\_25\_35\_50 mm² **EN** Jaw type HEX 6\_10\_16\_25\_35\_50 mm² **FR** Type de mâchoire HEX 6\_10\_16\_25\_35\_50 mm² **ES** Mordaza tipo HEX 6\_10\_16\_25\_35\_50 mm² **HU** Vrstas četjusti HEX 6\_10\_16\_25\_35\_50mm² **HU** Pofatípus **HEX** 6\_10\_16\_25\_35\_50 mm² **RO** Tipul de fălcă HEX 6\_10\_16\_25\_35\_50 mm² **BG** Тип челюсти HEX 6\_10\_16\_25\_35\_50 mm²

**DE** Backenart HEX **EN** Jaw type HEX **FR** Type de mâchoire **HEX** **ES** Mordaza tipo HEX **HR** Vrsta četjusti **HEX** **HU** Pofa típus **HEX** **RO** Tipul de fălcă **HEX** **BG** Тип челюсти **HEX**

**FLAT**  
**DE** Art der Scheibe FLACH **EN** Disc type FLAT **FR** Type de disque FLAT **ES** Tipo de disco PLANO **HR** Vrsta lista PLOSNAT **HU** Tárcsatisapú LAPOS **RO** Tipul de disc FLAT **BG** Тип диск FLAT

**CURVED**  
**DE** Art der Scheibe KONVEX **EN** Disc type CONVEX **FR** Type de disque CREUX **ES** Tipo de disco CONVEXO **HR** Vrsta lista KONVEXSAN **HU** Tárcsatisapú DOMBORÚ **RO** Tip disc GÖL **BG** Тип диск Криви

**ATB**  
**DE** Zahnart ATB **EN** Type of tooth ATB **FR** Type de dent ATB **ES** Tipo de diente ATB **HR** Vrsta zuba ATB **HU** Fog típus ATB **RO** Tip de dinți ATB **BG** Вид на зъба ATB

**SP SP**  
**DE** Art der Kupplungen für Telefonleitungen 6P 8P **EN** Telephone connector type 6P 8P **FR** Raccords téléphoniques type 6P 8P **ES** Conector telefónico tipo 6P 8P **HR** Vrsta telefonskih priključaka 6P 8P **HU** Telefonsatlakozók típusa 6P 8P **RO** Tip de conector telefonic tip 6P 8P **BG** Тип телефонен конектор 6P 8P

**RJ11 RJ12, RJ45**  
**DE** Art der Kupplungen für Telefonleitungen RJ 11\_12\_45 **EN** Telephone connector type RJ 11\_12\_45 **FR** Raccords téléphoniques de type RJ 11\_12\_45 **ES** Conector telefónico tipo RJ 11\_12\_45 **HR** Vrsta telefonskih priključaka RJ 11\_12\_45 **HU** Telefonsatlakozók típusa RJ 11\_12\_45 **RO** Tip de conector telefonic tip RJ 11\_12\_45 **BG** Тип телефонен конектор RJ 11\_12\_45

**PVC/PE/RR/RN**  
**DE** Arten der Isolierung PVC PE RR RN **EN** Insulation types PVC PE RR RN **FR** Types d'isolation PVC PE RR RN **ES** Tipos de aislamiento PVC PE RR RN **HR** Vrste izolacije PVC PE RR RN **HU** Szigetelés típusai PVC PE RR RN **RO** Tipuri de izolație PVC PE RR RN **BG** Видове изолация PVC PE RR RN

**14 x 19 mm**  
**DE** Größe des Schlüssels mit Ratsche 14 x 19 mm **EN** Ratchet spanner size 14 x 19 mm **FR** Taille de la clé à cliquet 14 x 19 mm **ES** Llave de carraca tamaño 14 x 19 mm **HR** Velicina ključa sa četrtajkom 14 x 19 mm **HU** Racsnis kulcs mérete 14 x 19 mm **RO** Cheie cu clichet, dimensiune 14 x 19 mm **BG** Ключ с тресчотка с размер 14 x 19 mm

**PE**  
**DE** PE-Rohre **EN** PE pipes **FR** Tuyaux PE **ES** Tubos de PE **HR** PE cijevi **HU** PE csövek **RO** Tevi PE **BG** Тръби PE

**PEX**  
**DE** PEX-Rohre **EN** PEX pipes **FR** Tuyaux PEX **ES** Tubos de PEX **HR** PEX cijevi **HU** PEX csövek **RO** Tevi PEX **BG** Тръби PEX

**PEX-AL**  
**DE** PEX-AL-Rohre **EN** PEX-AL pipes **FR** Tuyaux PEX-AL **ES** Tubos de PEX-AL **HR** PEX-AL cijevi **HU** PEX-AL csövek **RO** Tevi PEX-AL **BG** Тръби PEX-AL

**PP**  
**DE** PP-Rohre **EN** PP pipes **FR** Tuyaux PP **ES** Tubos de PP **HR** PP cijevi **HU** PP csövek **RO** Tevi PP **BG** Тръби PP

**PP-R**  
**DE** PP-R-Rohre **EN** PP-R pipes **FR** Tuyaux PP-R **ES** Tubos de PP-R **HR** PP-R cijevi **HU** PP-R csövek **RO** Tevi PP **BG** Тръби PP-R

**PVC**  
**DE** PVC-Rohre **EN** PVC pipes **FR** Tuyaux PVC **ES** Tubos de PVC **HR** PVC cijevi **HU** PVC csövek **RO** Tevi PVC **BG** Тръби PVC

**DE** Elektroakupplung, nicht isoliert **EN** Non-insulated electrical connector **FR** Connecteur électrique non isolé **ES** Conector eléctrico sin aislamiento **HR** Neizolirani električni priključak **HU** Nem szigetelt elektromos csatlakozó **RO** Conector electric neizolat **BG** Електрически конектор без изолация

**DE** Elektrische Hülsenkupplung, nicht isoliert **EN** Non-insulated electrical sleeve connector **FR** Raccord de manchon électrique non isolé **ES** Conector eléctrico con manguito sin aislamiento **HR** Neizolirani električni priključak tipa čahure **HU** Nem szigetelt elektromos csatlakozó **RO** Conector cu manșon electric neizolat **BG** Електрическият съединител на втулката не е изолиран

**DE** Elektroakupplung, Typ COAX **EN** COAX type electrical connector **FR** Connecteur électrique de type COAX **ES** Conector eléctrico tipo COAX **HR** Električni priključak tipa COAX **HU** Elektromos COAX típusú csatlakozó **RO** Conector electric tip COAX **BG** Електрически конектор тип COAX

**DE** Elektro-Hülsenkupplung, dünnwandig **EN** Thin-walled electrical sleeve connector **FR** Connecteur électrique femelle à paroi mince **ES** Conector eléctrico con manguito de pared fina **HR** Električni priključak tankih stjenki tipa čahure **HU** Vékonyfalú elektromos csatlakozó **RO** Conector cu manșon electric cu pereți subțiri **BG** Електрически съединител с тънки стени

**DE** Elektrische Hülsenkupplung, isoliert **EN** Insulated electrical sleeve connector **FR** Connecteur électrique femelle isolé **ES** Conector eléctrico de manguito con aislamiento **HR** Izolirani električni priključak tipa čahure **HU** Szigetelt elektromos csatlakozó **RO** Conector cu manșon electric izolat **BG** Електрически конектор с изолирана втулка

**DE** Schnittlängenskala 0-30 mm **EN** Cutting length scale 0-30 mm **FR** Échelle de longueur de coupe 0-30 mm **ES** Escala de longitud de corte 0-30 mm **HR** Skala dužine rezanja 0-30 mm **HU** Vágási hossz skála 0-30 mm **RO** Scară de lungime de tăiere 0-30 mm **BG** Скала за дължина на рязане 0-30 mm

**DE** Feder - spreizt automatisch den Griff **EN** Spring - automatically opens the handle **FR** Ressort - ouvre automatiquement la poignée **ES** Muelle - abre automáticamente el mango **HR** Opruga - otvara ručku automatski **HU** Rugó - automatikusan kinyitja a fogantyút **RO** Arc - deschide automat mânerul **BG** Пружина - автоматично отваря дръжката

**DE** Backenbreite 60 mm **EN** Jaw width 60 mm **FR** Largeur de la mâchoire 60 mm **ES** Ancho de mordaza 60 mm **HR** Širina četjusti 60 mm **HU** Pofaszélesség 60 mm **RO** Lățimea fălcii 60 mm **BG** Широчина на челюстите 60 mm

**DE** Schneller Klingenwechsel **EN** Rapid blade change **FR** Changement rapide de la lame **ES** Cambio rápido de cuchillas **HR** Brza izmjena oštrice **HU** Könnyű pengecser **RO** Încuire rapidă a matricei **BG** Бърза смяна на ножовете

**DE** Teleskopgriff 170-570 mm **EN** Telescopic handle 170-570 mm **FR** Manche télescopique 170-570 mm **ES** Mango telescópico 170-570 mm **HR** Teleskopska ručka 170 - 570 mm **HU** Teleszkópos fogantyú 170-570 mm **RO** Mâner telescopic 170-570 mm **BG** Телескопична дръжка 170-570 mm

**DE** Zahnstahlhärte 48-50 HRC **EN** Hardness of tooth steel 48-50 HRC **FR** Dureté de l'acier des dents 48-50 HRC **ES** Dureza del acero de los dientes 48-50 HRC **HR** Tvrdća čelika zuba 48-50 HRC **HU** Az acél fog keménysége 48-50 HRC **RO** Duritatea oțelului dinților 48-50 HRC **BG** Твърдост на зъбната стомана 48-50 HRC

**DE** Zahnstahlhärte 90\_7 HRA **EN** Hardness of tooth steel 90\_7 HRA **FR** Dureté de la dent en acier 90\_7 HRA **ES** Dureza del acero del diente 90\_7 HRA **HR** Tvrdća čelika zuba 90\_7 HRA **HU** Az acél fog keménysége 90\_7 HRA **RO** Duritatea oțelului dinților 90\_7 HRA **BG** Твърдост на зъбната стомана 90\_7 HRA

**DE** Magnetischer Nagelhalter **EN** Magnetic nail chuck **FR** Mandrin magnétique pour clous **ES** Soporte magnético para clavos **HR** Magnetni držač za čavle **HU** Mágneses szögártató **RO** Suport magnetic pentru cui **BG** Магнитен патроник за нокти

**DE** Tragkraft 2,2 kg **EN** Load capacity 2,2 kg **FR** Capacité de charge 2,2 kg **ES** Capacidad de carga 2,2 kg **HR** Nosivost 2,2 kg **HU** Terhelhetőség 2,2 kg **RO** Capacitate de încărcare 2,2 kg **BG** Капацитет на натоварване 2,2 кг

**DE** Schraubendreher PH1 **EN** PH1 screwdriver **FR** Tournevis PH1 **ES** Destornillador PH1 **HR** Odvijáč PH1 **HU** PH1 csavarhúzó **RO** Șurub PH1 **BG** Отвертка PH1

**DE** Auswechselbare Matrizen **EN** Interchangeable dies **FR** Matrices remplaçables **ES** Matrices intercambiables **HR** Zamjenjive matrice **HU** Cserélhető sbetétek **RO** Matrice interschimbabile **BG** Сменяеми матрици

**DE** Hartmetall **EN** Sintered carbide **FR** Carbone **ES** Carburo cementado **HR** Cementirani karbid **HU** Karbid **RO** Carbură **BG** Карбид

**DE** Durchmesser Seil 1,5 mm **EN** String diameter 1,5 mm **FR** Diamètre de la corde 1,5 mm **ES** Diámetro de la cuerda 1,5 mm **HR** Promjer konopca 1,5 mm **HU** Madzag átmérő 1,5 mm **RO** Diametru șnurului 1,5 mm **BG** Диаметър на струната 1,5 мм

**DE** Durchmesser Scheibe 125 mm **EN** Disc diameter 125 mm **FR** Diamètre du disque 125 mm **ES** Diámetro del disco 125 mm **HR** Promjer lista 125 mm **HU** Tárcsa átmérő 125 mm **RO** Diametru disc 125 mm **BG** Диаметър на диска 125 мм

**DE** Durchmesser Sauger 2x120 mm **EN** Suction cup diameter 2x120 mm **FR** Diamètre de la ventouse 2x120 mm **ES** Diámetro de la ventosa 2x120 mm **HR** Promjer usisne čašice 2x120 mm **HU** Tapadóelem átmérője 2x120 mm **RO** Diametru ventuzei 2x120 mm **BG** Диаметър на чашата за засмукване 2x120 mm

**7-8 mm SPARK PLUG WIRES**  
**DE** Zündleiterklemme 7-8 mm **EN** Ignition cable crimping tool 7-8 mm **FR** Outil de sertissage de câble d'allumage 7-8 mm **ES** Herramienta de engaste de cables de encendido 7-8 mm **HR** Alat za stiskanje žica paljenja 7-8 mm **HU** Gyújtókábel krimpelő szerzőszám 7-8 mm **RO** Instrument de sertizare a cablului de aprindere 7-8 mm **BG** Инструмент за пресоване на кабела за запалване 7-8 mm

**60-115 cm**  
**DE** Bereich 60-115 cm **EN** Range

**DE** Dieser Produktkatalog wurde von GTV Polen, dem exklusiven Vertriebspartner von Höfert Technik in Polen, erstellt und stellt kein Angebot im Sinne des Zivilgesetzbuches dar. GTV Poland ist ständig bestrebt, sein Angebot zu verbessern und an die sich ändernden Marktbedürfnisse anzupassen. Daher behält sich GTV Poland das Recht vor, Änderungen im präsentierten Sortiment vorzunehmen und ist nicht verantwortlich für die mangelnde Verfügbarkeit der in dieser Publikation vorgestellten Produkte. GTV Poland behält sich das Recht vor, (ohne Vorankündigung) Änderungen am präsentierten Sortiment in Bezug auf technische Parameter und Produktspezifikationen vorzunehmen.

Die in diesem Katalog vorgestellten Artikel können in der Tat von der auf den Fotos gezeigten Ausführung abweichen (insbesondere in Bezug auf äußere Merkmale, d. h. Größe, Farbe, Art der Verpackung, Anzahl der Artikel in einer Packung) und sich auch in Bezug auf technische Parameter unterscheiden. Aufgrund der verwendeten Drucktechnik kann die Farbe des vorliegenden Produkts vom Original abweichen. GTV Poland haftet nicht für Druckfehler oder Schäden, die sich aus der Verwendung der in dieser Publikation enthaltenen Informationen ergeben. Diese Veröffentlichung ist für die Geschäftspartner von GTV Polen bestimmt.

**EN** This product catalogue has been prepared by GTV Poland which is the exclusive distributor of Höfert Technik products in Poland and it does not constitute an offer within the meaning of the Civil Code. GTV Poland is constantly striving to improve its offer by adapting it to the changing market needs, therefore it reserves the right to introduce changes in the presented assortment and waives liability for lack of the products presented in this publication. GTV Poland reserves the right to introduce (without notice) changes to the presented assortment in terms of technical parameters and product specifications. The articles presented in this catalogue may in fact differ from the design shown in the photographs (especially as regards external features, i.e. size, colour, packaging, number of items in a package) and also in terms of technical parameters. Variations from the colours represented here can occur, subject to printing techniques. GTV Poland waives any liability for printing errors or any damages resulting from the use of the information contained in this publication. This publication is intended for GTV Poland business partners.

**FR** Le catalogue de produits que vous obtenez, a été préparé par la GTV Poland, qui est le distributeur exclusif des produits Höfert Technik en Pologne et il ne constitue pas une offre au sens du Code civil. La GTV Poland s'efforce constamment d'améliorer son offre, en l'adaptant aux besoins changeants du marché, en conséquence elle se réserve le droit d'apporter des modifications à l'assortiment de produits présentée et n'est pas tenue responsable du manque de disponibilité des produits inclus dans la présente publication. La GTV Poland se réserve le droit d'apporter (sans préavis) des modifications à l'assortiment de produits présenté en termes de paramètres techniques et de spécifications de produits. Les produits présentés dans le présent catalogue peuvent en effet différer du motif indiqué sur les photos (notamment en ce qui concerne les caractéristiques extérieures, c'est-à-dire la taille, la couleur, le mode d'emballage, le nombre de produits dans l'emballage) et également différer du point de vue de paramètres techniques. Vue la technique d'impression utilisée, la couleur du produit présenté peut différer de l'original. La GTV Poland n'est pas tenue responsable ni des erreurs d'impression, ni des dommages résultant de l'utilisation des informations contenues dans cette publication. La présente publication est adressée aux partenaires commerciaux de la GTV Poland.

**ES** Este catálogo de productos ha sido preparado por GTV Poland, el distribuidor exclusivo de los productos Höfert Technik en Polonia y no constituye una oferta en el sentido del Código Civil. GTV Poland se esfuerza constantemente por mejorar su oferta adaptándola a las necesidades cambiantes del mercado, por lo que se reserva el derecho de introducir cambios en la oferta presentada y no se hace responsable de la falta de disponibilidad de los productos presentados en esta publicación. GTV Poland se reserva el derecho de introducir (sin previo aviso) cambios en la oferta presentada dentro de parámetros técnicos y especificaciones de los productos. De hecho, los artículos presentados en este catálogo pueden diferir del diseño mostrado en las fotografías (en particular en lo que respecta a las características externas, es decir, el tamaño, el color, el método de embalaje, el número de artículos en un paquete) y también difieren en términos de parámetros técnicos. Debido a la técnica de impresión utilizada, el color del producto presentado puede diferir del original. GTV Poland no se responsabiliza de los errores de impresión ni de los daños derivados del uso de la información contenida en esta publicación. Esta publicación está destinada a los socios comerciales de GTV Poland y todas las empresas del grupo.

**HR** Ovaj katalog proizvoda pripremila je GTV Poland, koja je ekskluzivni distributer proizvoda Höfert Technik u Poljskoj i ne predstavlja ponudu u smislu gradanskog zakonika. GTV Poland neprestano radi na usavršavanju svoje ponude, prilagođavajući je promjenjivim potrebama tržišta, stoga zadržava pravo na izmjene prezentiranog asortimana i ne snosi odgovornost za nedovoljnu dostupnost proizvoda iz ove publikacije. GTV Poland zadržava pravo unošenja (bez prethodne najave) promjena prikazanog asortimana u smislu tehničkih parametara i specifikacija proizvoda. Proizvodi prikazani u ovom katalogu mogu se u stvari razlikovati u odnosu na uzorke navedene na fotografijama (osobito kada su u pitanju vanjske značajke, tj. veličina, boja, način pakiranja, broj artikala u pakiranju), a također se razlikuju i po tehničkim parametrima. Obzirom na tehniku tiska, boja predstavljenog proizvoda može se razlikovati u odnosu na original. GTV Poland nije odgovorna za tiskarske greške, kao ni za bilo kakvu štetu nastalu korištenjem podataka sadržanih u ovoj publikaciji. Ova publikacija namijenjena je komercijalnim partnerima GTV -a u Poljskoj.

**HU** Ezt a termékkatalógust a GTV Poland cég készítette, amely a Höfert Technik termékek kizárólagos forgalmazója Lengyelországban, és nem minősül a Polgári Törvénykönyv rendelkezéseinek értelmében vett ajánlatnak. A GTV Poland folyamatosan arra törekszik, hogy a változó piaci igényekhez igazítsa kínálatát, ezért fenntartja a jogot a bemutatott termékválaszték módosítására, és nem vállal felelősséget a kiadványban szereplő termékek elérhetőségének hiányáért. A GTV Poland fenntartja a jogot, hogy a bemutatott termékválasztékban előzetes értesítés nélkül változtatásokat vezessen be a műszaki paraméterek és a termékleírások tekintetében. A katalógusban bemutatott árucikkek a valóságban eltérhetnek a fényképeken feltüntetett mintáktól (különösen a külső jellemzők, azaz a méret, a szín, a csomagolás módja, a csomagolásban lévő tételek száma tekintetében), és azoktól műszaki paraméterek tekintetében is különbözhetnek. Az alkalmazott nyomtatási technikára való tekintettel a bemutatott termék színe eltérhet az eredetitől. A GTV Poland nem vállal felelősséget a nyomtatási hibákért, valamint a jelen kiadványban szereplő információk felhasználásából eredő esetleges károkat. A kiadvány a GTV Poland kereskedelmi partnereinek készült.

**RO** Acest catalog de produse a fost pregătit de GTV Poland, care este distribuitorul exclusiv al produselor Höfert Technik în Polonia și nu constituie o ofertă în sensul Codului Civil. GTV Poland se străduiește în mod constant să își îmbunătățească oferta prin adaptarea acesteia la nevoile în schimbare ale pieței, de aceea își rezervă dreptul de a introduce modificări în sortimentul prezentat și nu este responsabilă pentru lipsa de disponibilitate a produselor prezentate în această publicație. GTV Poland își rezervă dreptul de a introduce (fără preaviz) modificări în gama prezentată în ceea ce privește parametrii tehnici și specificațiile produselor.

Articolele prezentate în acest catalog pot să difere în realitate de modelul prezentat în fotografiile în special în ceea ce privește caracteristicile exterioare, de exemplu, dimensiunea, culoarea, modul de ambalare, numărul de articole dintr-un ambalaj și, de asemenea, pot fi diferite în ceea ce privește parametrii tehnici. Din cauza tehnicii de imprimare utilizate, culoarea produsului prezentat poate varia față de cea a originalului. GTV Poland nu este restonsabil pentru erorile de tipar sau pentru orice daune rezultate din utilizarea informațiilor conținute în această publicație. Această publicație este destinată partenerilor de afaceri ai GTV Poland.

**BG** Този продуктов каталог е изготвен от GTV Poland, който е изключителен дистрибутор на продуктите на Höfert Technik в Полша и не представлява oferta по смисъла на Гражданския кодекс. GTV Poland непрекъснато се стреми да подобрява своята oferta, като я адаптира към променящите се нужди на пазара, поради което си запазва правото да прави промени в представената oferta и не носи отговорност за липсата на наличност на продуктите, включени в тази публикация. GTV Poland си запазва правото да въвежда (без предизвестие) промени в представения асортимент по отношение на технически параметри и спецификации на продукта. Артикулите, представени в този каталог, могат действително да се различават от модела, посочен на снимките (по-специално що се отнася до външни характеристики, т.е. размер, цвят, начин на опаковане, брой артикули в опаковката) и също така да се различават по отношение на техническите параметри. Поради използваната техника на печат, цветът на представения продукт може да се различава от оригинала. GTV Poland не носи отговорност за печатни грешки, както и за всякакви щети, произтичащи от използването на информацията, съдържаща се в тази публикация. Тази публикация е предназначена за търговски партньори на GTV Poland.



## Högert Technik GmbH

Pariser Platz 6a, 10117 Berlin, Germany

Distribution in Poland GTV, Przejazdowa Street 21, 05-800 Pruszków, Poland



GTV Poland S.A.

Przejazdowa 21, 05-800 Pruszków, Poland

**+48 22 44 47 500**



Россия, 109428, город Москва,

Рязанский проспект, 8А, строение 7, этаж 2, кабинет 10

**+7 495 640 15 88**



GTV Croatia d.o.o.

Kovinska 4s, 10000 Zagreb, Hrvatska

**+385 1 798 8089**



GTV Czech Distribution s.r.o.

CTPark Ostrava, Na Rovince 879, 720 00 Ostrava Hrabová

**+420 591 160 091**



GTV España Herrajes, E Iluminación, S.L.,

Avenida Aragón 308, 46021 Valencia, Spain

**+34 960 468 666**

[www.hoegert.com](http://www.hoegert.com)

Follow us on:

